

XFT110

ЭЛЕКТРИЧЕСКИЙ

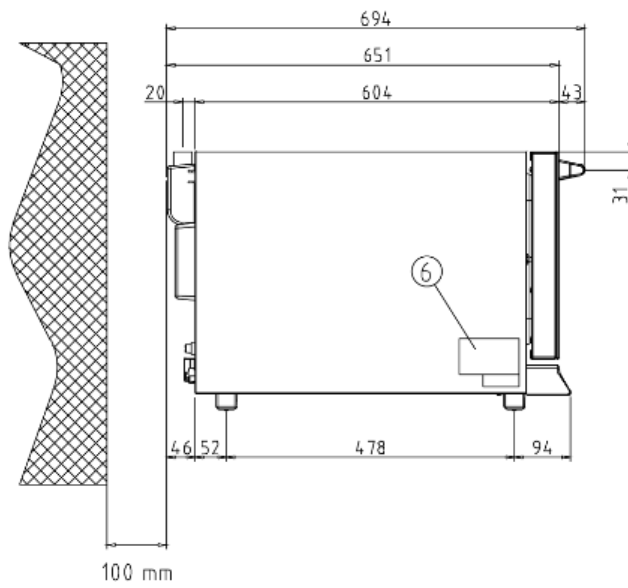

Вместимость	3 460x330
Расстояние	75 mm
Частота	50 / 60 Hz
Напряжение	230 V~ 1N
Мощность	3 kW
Размеры	600x651x429 mm
Вес	25 kg

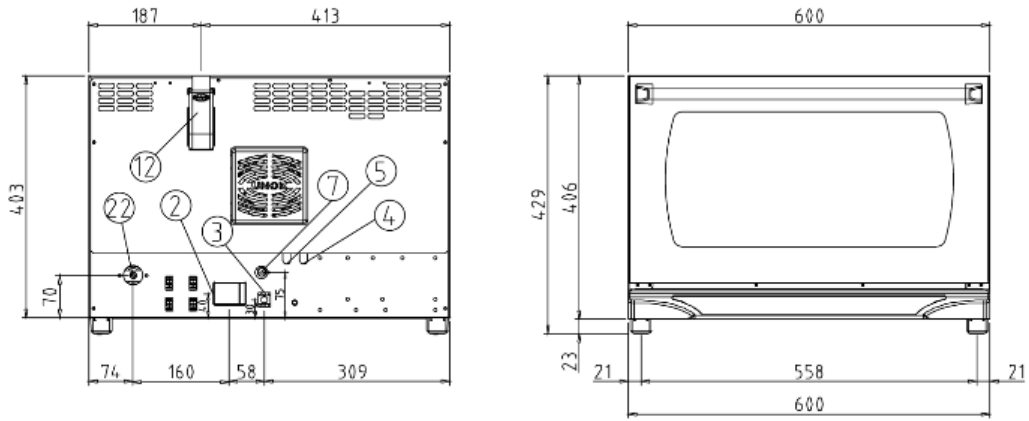

	MATIC	DYNAMIC	CLASSIC	MANUAL HUM.
■ :Standard □ :Optional - :Not available				
BAKING MODES				
Convection baking 30 °C - 260 °C	■	■	■	■
Mixed humidity and convection baking 90 °C - 260 °C	■	■	-	■
AIR DISTRIBUTION IN THE BAKING CHAMBER				
AIR.Plus technology: fans with reversing gear on models 600x400	■	■	■	■
AIR.Plus technology: fans with reversing gear on models 460x330	■	■	■	-
CLIMA MANAGEMENT IN THE BAKING CHAMBER				
DRY.Plus technology: quick extraction of the humidity from the baking chamber	■	■	■	■
STEAM.Plus technology: humidity injection that can be set from the control panel with 20% increment	■	■	-	-
STEAM.Plus technology: manual humidity injection	-	-	-	■
Pump that allows the oven to draw water from the tank (for models 460x330)	■	■	-	■
Solenoid valve that allows the connection between oven and water directly (for models 600x400)	■	■	-	■
PANS				
Aluminium flat pans (for models 460x330)	■	■	■	■
AUXILIARY FUNCTIONS				
99 baking programs memory, each one made up of 3 baking steps + pre-heating	■	■	■	-
Protek.SAFE™ technology: maximum thermal efficiency and working safety (cool door glass and external surfaces)	■	■	■	■
Visualisation of the residual baking time	■	■	■	■
Continuous functioning «INF»	■	■	■	■
Visualisation of the set and real temperature values in the oven chamber	■	■	■	-
Temperature unit that can be set in °C or °F	■	■	■	-
DOOR OPENING				
Manual door opening from top to bottom	-	■	■	■
Flag opening door from right to left	■	-	-	-
Automatic door opening at the end of the baking process	■	-	-	-
TECHNICAL DETAILS				
Rounded stainless steel chamber for hygiene and easy of cleaning	■	■	■	■
Oven chamber lighting with halogen lamp	■	■	■	■

Light weight – heavy duty structure using innovative materials	■	■	■	■
Proximity door contact switch on models 600x400	■	■	■	■
Proximity door contact switch on models 460x330	■	■	■	-
Autodiagnosys system for problems or brake down	■	■	■	-
Safety temperature switch	■	■	■	■