

TARGHETTA TECNICA

MANUALE D'USO
MANUEL D'INSTRUCTIONS
GEBRAUCHSANWEISUNG
OPERATOR'S HANDBOOK
MANUAL DE EMPLEO
HANDLEIDING
РУКОВОДСТВО К ИСПОЛЬЗОВАНИЮ



3169450

ARMADI FERMALIEVITAZIONE
ARMOIRES DE FERMENTATION
KÜHLSCHRÄNKE
PROVER CABINET
CABINAS FERMENTACION
KOELKASTEN
ХОЛОДИЛЬНЫЕ ШКАФЫ

Leggere attentamente le avvertenze contenute nel presente libretto in quanto forniscono importanti indicazioni riguardanti la sicurezza, d'uso e di manutenzione.

Conservare con cura questo libretto per ogni ulteriore consultazione dei vari operatori.

IT

Il costruttore si riserva il diritto di apportare modifiche al presente manuale, senza preavviso e responsabilità alcuna.

Lire avec attention les instructions contenues dans ce livret car elles fournissent d'importants renseignements pour ce qui concerne la sécurité, l'emploi et l'entretien.

Garder avec soin ce livret pour des consultations ultérieures de différents opérateurs.

FR

Le constructeur se réserve le droit d'apporter des modifications à ce manuel, sans préavis ni responsabilité d'aucune sorte.

Lesen Sie bitte aufmerksam diese Gebrauchsanweisung durch, die wichtige Informationen bezüglich der Sicherheit, dem Gebrauch und der Instandhaltung enthält.

Heben Sie sorgfältig diese Gebrauchsanweisung auf, damit verschiedene Anwender sie zu Rat ziehen können.

DE

Der Hersteller behält sich das Recht, Änderungen dieser Gebrauchsanweisung ohne Ankündigung und ohne Übernahme der Verantwortung vornehmen zu können.

Carefully read the instructions contained in the handbook. You may find important safety instructions and recommendations for use and maintenance.

Please retain the handbook for future reference.

GB

The Manufacturer is not liable for any changes to this handbook, which may be altered without prior notice.

Lea atentamente las advertencias contenidas en este manual pues dan importantes indicaciones concernientes la seguridad, la utilización y el mantenimiento del aparato.

Rogamos guarde el folleto de instalación y utilización, para eventuales futuros usuarios.

ES

El constructor se reserva el derecho de hacer modificaciones al actual manual, sin dar algún preaviso y sin responsabilidad alguna.

Nauwkeurig de waarschuwingen in dit boekje lezen, aangezien zij belangrijke aanwijzingen verschaffen wat betreft de veiligheid, het gebruik en het onderhoud.

Dit boekje goed bewaren.

NL

De fabrikant behoudt zich het recht voor om veranderingen in deze handleiding aan te brengen, zonder voorafgaande waarschuwing en zonder enkele aansprakelijkheid.

Внимательно читайте предупреждения, содержащиеся в настоящем руководстве, касающиеся надежности использования и обслуживания.

Бережно храните это руководство для каждой последующей консультации разных рабочих.

RU

Конструктор сохраняет за собой право вносить изменения в настоящее руководство без предупреждения и любой ответственности, без

INDICE

DESCRIZIONE MACCHINA	2
ACCESSORI	2
ETICHETTA DI IDENTIFICAZIONE	2
NOTE GENERALI ALLA CONSEGNA	3
PRESCRIZIONI DI SICUREZZA	3
PRESCRIZIONI HACCP	4
CARATTERISTICHE TECNICHE	4
MESSA IN OPERA ED INSTALLAZIONE	4
PANNELLI DI COMANDO	6
AVVIAMENTO	7
CARICAMENTO PRODOTTO	7
FUNZIONAMENTO <small>CICLO MANUALE – CICLO AUTOMATICO</small>	7
ARRESTO	12
SBRINAMENTO	12
REGOLAZIONE OROLOGIO	13
REGOLAZIONE ORA LEGALE	13
LINGUA	14
PROGRAMMAZIONE	14
ALLARMI E SEGNALAZIONI	19
IRREGOLARITA' DI FUNZIONAMENTO	21
PULIZIA GIORNALIERA	21
MACCHIE DI CIBO E RESIDUI INDURITI	21
PULIZIA E MANUTENZIONE PERIODICA	22
INTERRUZIONI D'USO	22
CONSIGLI PER LA MANUTENZIONE DELL'ACCIAIO INOSSIDABILE	22
PROBLEMI DI FUNZIONAMENTO	23
SMALTIMENTO RIFIUTI E DISMISSIONE	23
INVERSIONE PORTA	24
SCHEDA TECNICA DEL REFRIGERANTE	24

DESCRIZIONE MACCHINA

Quest'apparecchiatura è stata progettata per la refrigerazione, il riscaldamento e la conservazione degli alimenti. Ogni altro uso è da ritenersi improprio.

ATTENZIONE: le macchine non sono idonee per installazioni all'aperto e/o ambienti sottoposti alle azioni degli agenti atmosferici.

Il costruttore declina ogni responsabilità da usi non previsti dei prodotti.

Le apparecchiature sono disponibili con porte in acciaio.

Le apparecchiature sono realizzate con impianti di refrigerazione a "NORMALE TEMPERATURA" e a "BASSA TEMPERATURA" per soddisfare la conservazione degli alimenti alle diverse temperature. (1)

Le apparecchiature sono dotate di un evaporatore ad alette protetto contro l'ossidazione, di un compressore ermetico, di un condensatore in rame-alluminio, di un kit umidificazione, di una resistenza interna, di una sonda umidità e relativo pannello di comando. (2)

Le apparecchiature sono corredate da un pannello comandi, differenziato dal tipo di impostazioni riferite alla tipologia di apparecchio (TEMPERATURA POSITIVA, BASSA TEMPERATURA). (3)

I compressori sono alloggiati nella parte superiore degli apparecchi per usufruire di una buona areazione e dissipazione del calore. (4)

Le apparecchiature sono dotate di una bacinella, dotata di un dispositivo di evaporazione automatico della condensa, alloggiata sul retro esterno dell'apparecchio. (5)

Nessun apparecchiatura è dotata di bacinella raccogli condensa sul fondo esterno.

Le apparecchiature sono corredate di due differenti sistemi di illuminazione in funzione del modello. Le lampade interne sono protette per evitare il contatto con alimenti e da urti che potrebbero romperle. (8)

Le porte delle apparecchiature sono dotate di serratura a chiave per garantire una sicura chiusura. (9)

Le zone a contatto con il prodotto sono realizzate in acciaio. (10)

Nei gruppi refrigeranti viene impiegato fluido refrigerante consentito dalle attuali legislazioni, del tipo HFC.

ACCESSORI

Vedi figura 7.

ETICHETTA DI IDENTIFICAZIONE

Per qualsiasi comunicazione con il costruttore citare sempre il MODELLO ed il NUMERO DI MATRICOLA della macchina, riportati sulla targa caratteristiche tecniche. (11)

Contenuto Campi Targhetta Tecnica (12)

- | | |
|--|---|
| 1) MODELLO | F) CORRENTE FUSIBILE |
| 2) AZIENDA COSTRUTTRICE E INDIRIZZO | G) TIPO FLUIDO REFRIGERANTE |
| 3) SIGLA MARCATURA CE | H) QUANTITÀ FLUIDO REFRIGERANTE |
| 4) ANNO DI COSTRUZIONE | L) CLASSE DI TEMPERATURA IMPIANTO FRIGORIFERO |
| 5) N° DI MATRICOLA | M) PRESSIONE MASSIMA ACQUA |
| 6) CLASSE DI ISOLAMENTO ELETTRICO | N) TEMPERATURA ACQUA |
| 7) CLASSE DI PROTEZIONE ELETTRICA | O) CONSUMO ACQUA |
| A) TENSIONE DI ALIMENTAZIONE ELETTRICA | P) PRESSIONE MINIMA ACQUA |
| B) INTENSITÀ DI CORRENTE ELETTRICA | R) SIMBOLO RAEE |
| C) FREQUENZA | W) POTENZA ELEMENTI RISCALDANTE |
| D) POTENZA NOMINALE | |
| E) POTENZA TOTALE LAMPADE | |

NOTE GENERALI ALLA CONSEGNA

Alla consegna verificare che l'imballo sia integro e che durante il trasporto non abbia subito danni. (13)

Dopo aver sballato l'apparecchio verificare che vi siano tutte le parti o componenti e che le caratteristiche e lo stato corrispondano alle specifiche dell'ordine da voi richieste.

Se così non fosse mettersi immediatamente in contatto con il rivenditore. (14)

Nel complimentarci con Voi per la vostra ottima scelta ci auguriamo che possiate utilizzare al meglio le nostre apparecchiature seguendo le indicazioni e le precauzioni necessarie contenute in questo manuale. (15)

Ricordate che è vietata qualsiasi riproduzione del presente manuale e che per una costante ricerca di innovazione e qualità tecnologica le caratteristiche qui riportate potrebbero cambiare senza preavviso.

PRESCRIZIONI DI SICUREZZA

ATTENZIONE: prima di qualsiasi operazione di manutenzione o pulizia bisogna isolare l'apparecchiatura dall'energia elettrica:

Portare l'interruttore presente sul cruscotto in posizione OFF (16a)

portare l'interruttore generale nella posizione OFF. (16b)

togliere la spina (17)

ATTENZIONE: non impiegare prese o spine non provviste di messa a terra. (18)

La presa di rete deve essere provvista di MESSA A TERRA. (19)

ATTENZIONE: non usare per il collegamento alla rete adattatori o prolunghe. (20)

ATTENZIONE: attendere un tempo necessario al raggiungimento della temperatura impostata prima di inserire il cibo da conservare. (21)

Coprire sempre gli alimenti con le apposite pellicole prima di inserirli negli apparecchi. (22)

ATTENZIONE: non introdurre nel frigorifero bevande o cibi caldi. (23)

ATTENZIONE: provvedere allo stoccaggio dei prodotti da conservare in maniera tale da non debordare dalle griglie onde non ostacolare il flusso dell'aria. Non ostruire la zona di aspirazione dei ventilatori. (24)

ATTENZIONE: non effettuare le pulizie delle zone circostanti l'apparecchio quando la porta è aperta. (25)

Non lavare l'apparecchio con getti di acqua diretti e ad alta pressione. (26)

ATTENZIONE: non usare sostanze a base di cloro (candeggina, acido muriatico, ecc.) o comunque tossiche per la pulizia o in vicinanza delle apparecchiature. (27)

ATTENZIONE: non ostruire la parte superiore dell'apparecchiatura o le prese d'aria, quando è in funzione o sotto tensione elettrica. (28)

ATTENZIONE: non appoggiare oggetti sul fondo dell'apparecchio. Servirsi delle apposite griglie/teglie. (29)
Il peso massimo distribuito sugli appoggi deve essere di 48Kg.

La pulizia e la manutenzione dell'impianto refrigerante, della zona compressori e del kit umidificazione richiede l'intervento di un tecnico specializzato e autorizzato, per questo motivo non può essere effettuata da personale non idoneo. (30)

Per interventi di manutenzione o in caso di anomalie disinserire completamente l'apparecchiatura; richiedere l'intervento del SERVIZIO ASSISTENZA ad un centro autorizzato e l'impiego di ricambi originali. (31)

L'inadempienza di quanto sopra può compromettere lo stato di sicurezza degli apparecchi.

PRESCRIZIONI HACCP

ATTENZIONE: I prodotti facilmente deperibili devono essere tolti dall'ambiente refrigerato il più tardi possibile al fine di restare esposti alla temperatura ambiente il tempo indispensabile.

ATTENZIONE: Non ricongelare alimenti precedentemente scongelati.

ATTENZIONE: Numerare le attrezzature e controllare due volte al giorno la temperatura rilevata registrando i valori su apposito foglio da conservare per 24 mesi.

ATTENZIONE: Eventuali interruzioni di corrente agli apparecchi possono essere effettuate controllando il tempo di fermo tramite un orologio elettrico al fine di eliminare gli alimenti che potrebbero danneggiarsi.

Temperature massime ammesse per le merci

Alimento	Temperatura di stoccaggio (°C)	Temperatura massima di trasporto (°C)
Latte fresco pastorizzato	0÷+4	9
Panna fresca	0÷+4	9
Yoghurt, ricotta e formaggi freschi	0÷+2	9
Prodotti della pesca sotto ghiaccio	0÷+2	0÷+4

CARATTERISTICHE TECNICHE

Le dimensioni degli apparecchi sono riportati nell'ultima pagina del libretto. (32)

MESSA IN OPERA ED INSTALLAZIONE

Gli apparecchi vengono sempre spediti su pallett e protetti da scatola in cartone. (33)

Al ricevimento e dopo aver effettuato lo sbalaggio in caso di danni o parti mancanti comportarsi come descritto al capitolo "NOTE GENERALI ALLA CONSEGNA".

Le operazioni di messa in opera e di installazione devono essere effettuate da personale specializzato. (30)

Rimuovere la scatola imballo facendo attenzione a non ammaccare le superfici dell'apparecchiatura. (34)

ATTENZIONE: gli elementi dell'imballaggio (sacchetti in plastica, polistirolo espanso, chiodi, ecc.) non devono essere lasciati alla portata dei bambini in quanto potenziali fonti di pericolo.

Con un carrello a forche sollevare il frigorifero e portarlo sul luogo d'installazione facendo attenzione che il carico non sia sbilanciato. (35)

ATTENZIONE: non trasportare mai l'apparecchiatura in posizione orizzontale; tale operazione potrebbe causare danni strutturali ed impiantistici all'apparecchio. (36)

ATTENZIONE: sia per il posizionamento sul posto d'installazione come per gli spostamenti futuri non spingere o trascinare l'apparecchio, per evitare che si ribalti o creare danni ad parti dello stesso. (37)

ATTENZIONE: non posizionare l'apparecchio in vicinanza di fonte di calore o in ambienti con temperature elevate questo causerebbe minor rendimento e maggiore usura dello stesso. (38)

ATTENZIONE: Tenere una distanza dal soffitto di almeno 50cm. E' possibile affiancare gli apparecchi, ma nel caso di formazione condensa, allontanarli di almeno 2cm.

Togliere la pellicola protettiva dal prodotto.

Questa operazione può provocare scosse fastidiose, anche se non pericolose (elettricità statica).

L'inconveniente si riduce o si elimina mantenendo una mano sempre a contatto con l'apparecchio o collegando a terra l'involucro esterno. (39)

Dopo aver posizionato la macchina rimuovere il pallet servendosi di uno scalpello ed una mazzuola, facendo attenzione a non danneggiare i piedini all'interno dei masselli o l'apparecchio. (40)

Estrarre il massello di rinforzo in legno dalle feritoie sulla parte inferiore. (41)

Il tubo di scarico sifone presente sotto l'apparecchio deve essere collegato direttamente alla rete fognaria con scarico aperto. (41a)

Il tubo di alimentazione (attacco 3/4") acqua presente nella parte superiore dell'apparecchio deve essere collegato alla rete idrica tramite una valvola di intercettazione, un filtro a cartuccia e valvola di non ritorno. (41b)

La temperatura dell'acqua di alimentazione deve essere compresa tra 5°C e 40°C.

La pressione dell'acqua deve essere sufficiente a garantire un buon funzionamento dell'apparecchio (>1bar). Se l'acqua impiegata è particolarmente ricca di impurità è consigliabile utilizzare filtri o depuratori atti a trattarla.

A questo punto è possibile regolare i piedini. (42)

Livellare l'apparecchio tenendolo leggermente inclinato sul retro per permettere l'autochiusura ottimale della/e porta/e. (43)

Pulire con acqua tiepida e sapone neutro (come descritto al capitolo "PULIZIA") e montare gli accessori situati all'interno dell'apparecchio.

L'apparecchio è dotato di spina elettrica tipo SHUKO. Verificare la corrispondenza della stessa alle norme EN60320 e alle norme nazionali. Sostituire la spina con una a norme in caso di non corrispondenza. (44)

ATTENZIONE: l'operazione deve essere effettuata da un tecnico specializzato. (30)

Verificare che la tensione di rete corrisponda a quella riportata sulla targhetta delle caratteristiche tecniche dell'apparecchio. (45)

Inserire quindi la spina nell'apposita presa di rete. (46)

A questo punto le operazioni di messa in opera sono terminate.

L'apparecchiatura deve essere inoltre inclusa in un sistema equipotenziale la cui efficienza deve essere verificata secondo le norme in vigore. Il collegamento viene effettuato mediante una vite contrassegnata dalla sigla "Equipotenziale" posta nella zona compressori. (47)

PANNELLI DI COMANDO

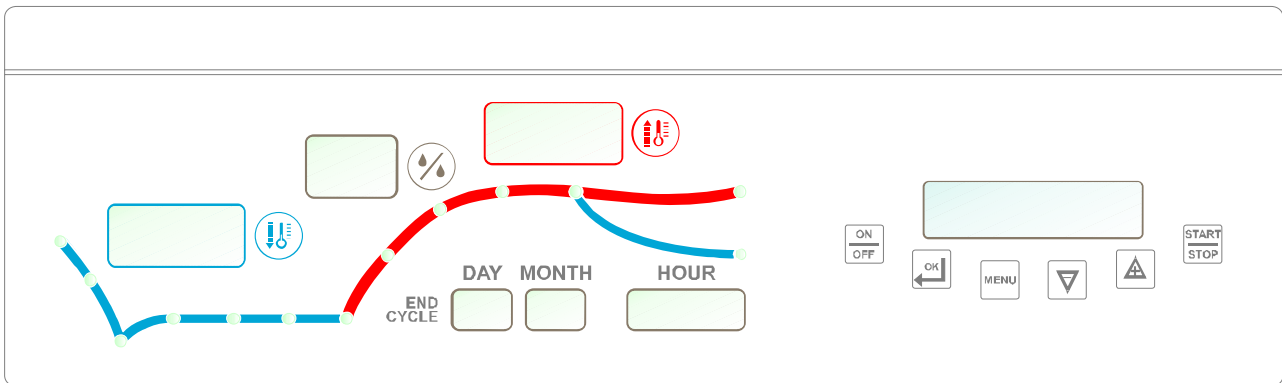

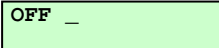
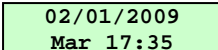
	<p><u>Tasto ON/OFF</u> Premendo il tasto per 3 sec il controllore si spegne e sul display compare la scritta </p> <p>Premendo successivamente il tasto, il controllore si riaccende e viene visualizzato </p>
	<p><u>Tasto Enter</u> Permette di accedere ad un menù o selezionare un parametro. <i>Durante un ciclo, la pressione del tasto permette di visualizzare data e ora.</i></p>
	<p><u>Tasto Menu</u> Permette di accedere al menù principale o di ritornare al menù precedente.</p>
	<p><u>Tasti Up e Down</u> Permettono di scorrere i vari menù o di variare i valori dei parametri.</p>
	<p><u>Tasto Start/Stop</u> Permette di avviare/bloccare un ciclo. <i>Con apparecchio a riposo, premendo il tasto per 3 sec, parte automaticamente il programma relativo al giorno della settimana in cui si effettua l'attivazione.</i></p>
	<p>Visualizza la temperatura in cella durante la fase di refrigerazione, conservazione o blocco lievitazione</p>
	<p>Visualizza la percentuale di umidità in cella. <i>E' acceso durante le fasi in cui è previsto il controllo dell'umidità.</i></p>
	<p>Visualizza la temperatura in cella durante la fase di riscaldamento, climatizzazione, lievitazione, rallentamento o risveglio</p>
	<p>Indicano data e ora. <i>Visualizzano giorno, mese e ora reale con scheda in standby o ciclo manuale in corso.</i> <i>Visualizzano giorno, mese e ora di fine ciclo se ciclo automatico in corso.</i></p>

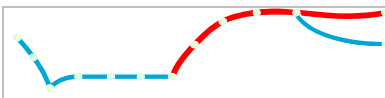

Visualizza lo stato di avanzamento del ciclo selezionato.
 I led relativi alle fasi già concluse rimangono accesi durante l'esecuzione delle fasi seguenti.

La scheda prevede la possibilità di impostare dei cicli **automatici** o di eseguire un ciclo **manuale**.

Ciclo manuale: impostazione delle 3 fasi:
 REFRIGERAZIONE, RISCALDAMENTO E CLIMATIZZAZIONE

Cicli automatici: (7 cicli impostati e/o modificabili) costituiti dalle seguente fasi:
 BLOCCO DELLA LIEVITAZIONE, CONSERVAZIONE, RISVEGLIO, LIEVITAZIONE E RALLENTAMENTO

AVVIAMENTO

Per avviare l'apparecchio eseguire le seguenti operazioni :

- inserire la spina nell'apposita presa di rete; (50)
- portare l'interruttore di linea in posizione ON; (51)

- premere il tasto  ;

Il display visualizza

02/01/2009
 Mar 17:35

CARICAMENTO PRODOTTO

A questo punto e non prima è possibile introdurre negli apparecchi gli alimenti da conservare.







- Distribuire il prodotto all'interno della cella uniformemente per consentire una buona circolazione dell'aria.
- Evitare di occludere le zone di ventilazione all'interno dell'apparecchio. All'interno della cella sono posti degli adesivi che indicano il limite di carico delle griglie.
- Non lasciare la porta aperta più del necessario durante il prelievo o l'introduzione degli alimenti.
- Si consiglia di tenere le chiavi fuori dalla portata dei bambini.



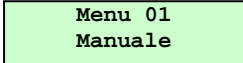

FUNZIONAMENTO

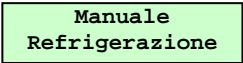
CICLO MANUALE

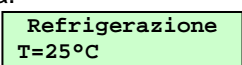













Il ciclo manuale è costituito da 3 fasi indipendenti e il passaggio da una fase ad un'altra **non è automatico**.

FASE DI REFRIGERAZIONE



	Premere il tasto <u>menù</u> per selezionare il menù desiderato	
	Utilizzare i tasti up e down per visualizzare	
	Premere il tasto <u>enter</u> per confermare la scelta	
	Premere i tasti <u>up</u> e <u>down</u> per visualizzare	
	Premere il tasto <u>enter</u> per confermare la scelta. Viene visualizzato	













	Premere il tasto <u>enter</u> per entrare nella modalità di modifica dei SetPoint. <i>Il valore del SetPoint Temperatura lampeggia, utilizzare i tasti  e  per modificare il valore</i>				
	Premere il tasto <u>enter</u> per confermare il nuovo valore				
	Premere il tasto <u>start/stop</u> per attivare immediatamente la fase selezionata. Viene visualizzato <table border="1" data-bbox="662 472 903 533"><tr><td>Manuale</td><td>13:39</td></tr><tr><td>T=5°C</td><td></td></tr></table>	Manuale	13:39	T=5°C	
Manuale	13:39				
T=5°C					

FASE DI RISCALDAMENTO

	Premere il tasto <u>menù</u> per selezionare il menù desiderato				
 	Utilizzare i tasti up e down per visualizzare <table border="1" data-bbox="959 759 1200 819"><tr><td>Menu 01</td></tr><tr><td>Manuale</td></tr></table>	Menu 01	Manuale		
Menu 01					
Manuale					
	Premere il tasto <u>enter</u> per confermare la scelta				
 	Premere i tasti <u>up</u> e <u>down</u> per visualizzare <table border="1" data-bbox="951 990 1192 1050"><tr><td>Manuale</td></tr><tr><td>Riscaldamento</td></tr></table>	Manuale	Riscaldamento		
Manuale					
Riscaldamento					
	Premere il tasto <u>enter</u> per confermare la scelta. Viene visualizzato <table border="1" data-bbox="943 1122 1184 1182"><tr><td>Riscaldamento</td></tr><tr><td>T=25°C UR=80%</td></tr></table>	Riscaldamento	T=25°C UR=80%		
Riscaldamento					
T=25°C UR=80%					
	Premere il tasto <u>enter</u> per entrare nella modalità di modifica dei SetPoint. <i>Il valore del SetPoint Temperatura lampeggia, utilizzare i tasti  e  per modificare il valore</i>				
	Premere il tasto <u>enter</u> per confermare il nuovo valore. <i>Il valore del SetPoint di Umidità lampeggia, utilizzare i tasti  e  per modificare il valore</i>				
	Premere il tasto <u>enter</u> per confermare il nuovo valore				
	Premere il tasto <u>start/stop</u> per attivare immediatamente la fase selezionata. Viene visualizzato <table border="1" data-bbox="662 1592 903 1653"><tr><td>Manuale</td><td>13:39</td></tr><tr><td>T=5°C</td><td>%rH=63%</td></tr></table>	Manuale	13:39	T=5°C	%rH=63%
Manuale	13:39				
T=5°C	%rH=63%				

FASE DI CLIMATIZZAZIONE

	Premere il tasto <u>menù</u> per selezionare il menù desiderato		
 	Utilizzare i tasti up e down per visualizzare <table border="1" data-bbox="959 1881 1200 1942"><tr><td>Menu 01</td></tr><tr><td>Manuale</td></tr></table>	Menu 01	Manuale
Menu 01			
Manuale			

	Premere il tasto <u>enter</u> per confermare la scelta
 	Premere i tasti <u>up</u> e <u>down</u> per visualizzare Manuale Climatizzazione
	Premere il tasto <u>enter</u> per confermare la scelta. Viene visualizzato Climatizzazione T=25°C UR=80%
	Premere il tasto <u>enter</u> per entrare nella modalità di modifica dei SetPoint. <i>Il valore del SetPoint Temperatura lampeggia, utilizzare i tasti  e  per modificare il valore</i>
	Premere il tasto <u>enter</u> per confermare il nuovo valore. <i>Il valore del SetPoint di Umidità lampeggia, utilizzare i tasti  e  per modificare il valore</i>
	Premere il tasto <u>enter</u> per confermare il nuovo valore
	Premere il tasto <u>start/stop</u> per attivare immediatamente la fase selezionata. Viene visualizzato Manuale 13:39 T=5°C %rH=63%

CICLO AUTOMATICO

La scheda elettronica ha memorizzati 7 cicli automatici come di seguito:

APPARECCHI -5°C/+30°C

CICLO		P1	P2	P3	P4	P5	P6	P7
		Lunedì	Martedì	Mercoledì	Giovedì	Venerdì	Sabato	Domenica
BLOCCO	Durata	02:00	02:00	02:00	02:00	02:00	02:00	02:00
	Temperatura	-5°C	-5°C	-5°C	-5°C	-5°C	-5°C	-5°C
CONSERVAZIONE	Temperatura	-1°C	-1°C	-1°C	-1°C	-1°C	-1°C	-1°C
	Durata	02:00	02:00	02:00	02:00	02:00	02:00	02:00
RISVEGLIO	Temperatura	20°C	20°C	20°C	20°C	20°C	20°C	20°C
	Umidità	70%	70%	70%	70%	70%	70%	70%
	Durata	02:00	02:00	02:00	02:00	02:00	02:00	02:00
LIEVITAZIONE	Temperatura	28°C	28°C	28°C	28°C	28°C	28°C	28°C
	Umidità	80%	80%	80%	80%	80%	80%	80%
	Durata	02:00	02:00	02:00	02:00	02:00	02:00	02:00
FINE PROGRAMMA	Ora	01:00	01:00	01:00	01:00	01:00	01:00	01:00
BLOCCO	Temperatura	6°C	6°C	6°C	6°C	6°C	6°C	6°C
	Umidità	80%	80%	80%	80%	80%	80%	80%

APPARECCHI -18°C/+30°C

CICLO		P1	P2	P3	P4	P5	P6	P7
		Lunedì	Martedì	Mercoledì	Giovedì	Venerdì	Sabato	Domenica
BLOCCO	Durata	02:00	02:00	02:00	02:00	02:00	02:00	02:00
	Temperatura	-20°C	-20°C	-20°C	-20°C	-20°C	-20°C	-20°C
CONSERVAZIONE	Temperatura	-1°C	-1°C	-1°C	-1°C	-1°C	-1°C	-1°C
	Durata	02:00	02:00	02:00	02:00	02:00	02:00	02:00
RISVEGLIO	Temperatura	20°C	20°C	20°C	20°C	20°C	20°C	20°C
	Umidità	70%	70%	70%	70%	70%	70%	70%
	Durata	02:00	02:00	02:00	02:00	02:00	02:00	02:00
LIEVITAZIONE	Temperatura	28°C	28°C	28°C	28°C	28°C	28°C	28°C
	Umidità	80%	80%	80%	80%	80%	80%	80%
	Durata	02:00	02:00	02:00	02:00	02:00	02:00	02:00
FINE PROGRAMMA	Ora	01:00	01:00	01:00	01:00	01:00	01:00	01:00
BLOCCO	Temperatura	6°C	6°C	6°C	6°C	6°C	6°C	6°C
	Umidità	80%	80%	80%	80%	80%	80%	80%







APPARECCHI -2°C / +30°C

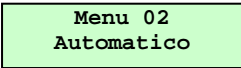

CICLO		P1	P2	P3	P4	P5	P6	P7
		Lunedì	Martedì	Mercoledì	Giovedì	Venerdì	Sabato	Domenica
BLOCCO	Durata	02:00	02:00	02:00	02:00	02:00	02:00	02:00
	Temperatura	-2°C	-2°C	-2°C	-2°C	-2°C	-2°C	-2°C
CONSERVAZIONE	Temperatura	+2°C	+2°C	+2°C	+2°C	+2°C	+2°C	+2°C
RISVEGLIO	Durata	02:00	02:00	02:00	02:00	02:00	02:00	02:00
	Temperatura	20°C	20°C	20°C	20°C	20°C	20°C	20°C
	Umidità	70%	70%	70%	70%	70%	70%	70%
LIEVITAZIONE	Durata	02:00	02:00	02:00	02:00	02:00	02:00	02:00
	Temperatura	28°C	28°C	28°C	28°C	28°C	28°C	28°C
	Umidità	80%	80%	80%	80%	80%	80%	80%
FINE PROGRAMMA	Ora	01:00	01:00	01:00	01:00	01:00	01:00	01:00
BLOCCO	Temperatura	6°C	6°C	6°C	6°C	6°C	6°C	6°C
	Umidità	80%	80%	80%	80%	80%	80%	80%

*Nota: Temperatura massima impasto 27°C – farina vxx 320 – aumentare 0,01 lievito – aumentare 0,01 sale per prodotti salati o zucchero per prodotti dolci

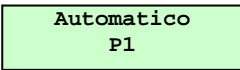
Ogni ciclo automatico è costituito da 5 cinque fasi.

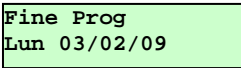



Il ciclo inizia sempre dalla fase di **BLOCCO DELLA LIEVITAZIONE** e il passaggio alle fasi successive avviene in modo **automatico** in base alla durata di ogni singola fase ed al giorno e ora di termine del ciclo impostati.







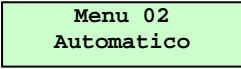

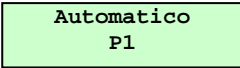









	Premere il tasto <i>menù</i> per selezionare il menù desiderato
	Utilizzare i tasti <i>up</i> e <i>down</i> per visualizzare 
	Premere il tasto <i>enter</i> per entrare nella selezione dei programmi già memorizzati (P01... P07). Viene visualizzato 
	Utilizzare i tasti <i>up</i> e <i>down</i> per scegliere il programma desiderato
	Premere il tasto <i>enter</i> . Viene visualizzato 

Se la data di termine indicata è quella desiderata, premere il tasto  , per confermare ed avviare l'esecuzione del ciclo, altrimenti premere il tasto  per modificare la data di fine ciclo.

MODIFICA CICLO AUTOMATICO

Per modificare i cicli pre-impostati seguire le istruzioni seguenti.



	Premere il tasto <i>menù</i> per selezionare il menù desiderato
	Utilizzare i tasti up e down per visualizzare 
	Premere il tasto <i>enter</i> per entrare nella selezione dei programmi già memorizzati (P01... P07). Viene visualizzato 



 	Utilizzare i tasti <u>up</u> e <u>down</u> per scegliere il programma desiderato
	Premere il tasto <u>enter</u> per entrare nella modalità di impostazione del programma selezionato
	Con il tasto <u>down</u> è possibile passare da una fase all'altra e sul display viene visualizzata la fase del ciclo con i valori correnti dei setpoint
	Premere il tasto <u>enter</u> per entrare in modifica. Il valore delle <i>Ore</i> diventa lampeggiante. Utilizzare i tasti  e  per modificare il valore.
	Premere il tasto <u>enter</u> per confermare il nuovo valore, il dato non lampeggia più. Il valore dei <i>Minuti</i> diventa lampeggiante. Utilizzare i tasti  e  per modificare il valore.
	Premere il tasto <u>enter</u> per confermare il nuovo valore, il dato non lampeggia più. Il valore del <i>SetPoint di Temperatura</i> diventa lampeggiante. Utilizzare i tasti  e  per modificare il valore.
	Premere il tasto <u>enter</u> per confermare il nuovo valore, il dato non lampeggia più. Il valore del <i>SetPoint di Umidità</i> diventa lampeggiante (se presente). Utilizzare i tasti  e  per modificare il valore.
	Premere il tasto <u>enter</u> per confermare il nuovo valore, il dato non lampeggia più. Utilizzare i tasti  e  per selezionare le altre fasi e modificarne i Setpoint.

La pressione del tasto  permette la memorizzazione del programma ed il ritorno al menu precedente.

La pressione del tasto  permette invece di avviare l'esecuzione del programma, il display visualizza la data di fine ciclo.

Fine Prog
Lun 03/04/06

Se la data di termine indicata è quella desiderata, premere il tasto , per confermare ed avviare l'esecuzione del ciclo, altrimenti premere il tasto  per modificare la data di fine ciclo.

Il giorno lampeggia, con il tasto  spostare la data di fine programma, premere il tasto  per confermare la nuova data e premere il tasto  per avviare l'esecuzione del ciclo.

ESECUZIONE DI UN CICLO AUTOMATICO

Durante l'esecuzione di un ciclo automatico il display visualizza:

P2 Bloccaggio
T=19°C

Indicando il numero del programma in corso, la fase in corso, la temperatura attuale in cella e se la fase prevede anche umidificazione con sonda, viene visualizzata la percentuale di umidità presente.

Visualizzare data e ora delle fasi

Premere il tasto  per visualizzare data e ora di fine della fase in corso.

Premere il tasto  per visualizzare data e ora di fine delle fasi successive.

Viene visualizzato

Fine F0 09:00
Lun 03/04/09

Dove F0 indica che è in corso la fase 0 del programma, precisamente la fase di Bloccaggio.

Le altre fasi sono indicate con:

F1 che indica Conservazione

F2 che indica Risveglio

F3 che indica Lievitazione

F4 che indica Rallentamento

La pressione del tasto , oppure un timeout di 5 secondi, riportano alla visualizzazione precedente.

Visualizzare stato INPUT/OUTPUT

Premere il tasto  per visualizzare lo stato degli INPUT/OUTPUT.

C	D	E	R	V	H	U
1	0	0	1	1	0	0

La pressione del tasto , oppure un timeout di 20 secondi, riportano alla visualizzazione precedente.

Visualizzare data e ora

Premere il tasto  per visualizzare la data e l'ora.









08/02/2007
Mar 17:35

La pressione del tasto , oppure un timeout di 5 secondi, riportano alla visualizzazione precedente.

In qualsiasi istante la pressione del tasto  blocca l'esecuzione del ciclo. Il ciclo rimane comunque selezionato.

CICLO RAFFREDDAMENTO

Si consiglia di avviare un ciclo di raffreddamento prima di selezionare un qualsiasi ciclo.

	Premere il tasto <u>menù</u> per selezionare il menù desiderato		
 	Utilizzare i tasti up e down per visualizzare <table border="1" data-bbox="965 1220 1204 1288"><tr><td>Menu 03</td></tr><tr><td>Raffredda</td></tr></table>	Menu 03	Raffredda
Menu 03			
Raffredda			
	Premere il tasto <u>enter</u> per entrare nella modalità di modifica dei SetPoint. <i>Il valore del SetPoint Temperatura lampeggia, utilizzare i tasti  e  per modificare il valore.</i>		
	Premere il tasto <u>enter</u> per confermare il nuovo valore		
	Premere il tasto <u>start/stop</u> per attivare immediatamente il ciclo di raffreddamento Viene visualizzato <table border="1" data-bbox="678 1590 917 1657"><tr><td>Raffredda 06:18</td></tr><tr><td>T=-6°C</td></tr></table>	Raffredda 06:18	T=-6°C
Raffredda 06:18			
T=-6°C			

Premendo il tasto  è possibile tornare alla modifica del SetPoint.

ARRESTO

In qualsiasi condizione per arrestare l'apparecchiatura è sufficiente premere il tasto  ;





sul display viene visualizzato

OFF _

ATTENZIONE: il tasto  NON isola l'apparecchio dalla tensione elettrica.

Per isolare l'apparecchio dalla tensione elettrica togliere la spina dalla presa. (17)

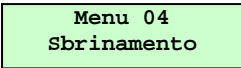

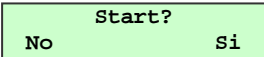





SBRINAMENTO

	Premere il tasto <u>menù</u> per selezionare il menù desiderato
 	Utilizzare i tasti up e down per visualizzare 
	Premere il tasto <u>enter</u> per accedere alla richiesta start di sbrinamento Viene visualizzato 

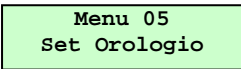

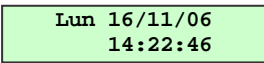

Premere il tasto  per uscire dal menu e lo sbrinamento non viene attivato.



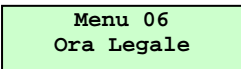

Premere il tasto  per attivare uno sbrinamento.

REGOLAZIONE OROLOGIO

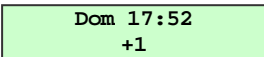







	Premere il tasto <u>menù</u> per selezionare il menù desiderato
 	Utilizzare i tasti up e down per visualizzare 
	Premere il tasto <u>enter</u> per entrare nella modalità di impostazione orologio. Viene visualizzato  Utilizzare i tasti  e  per modificare la cifra lampeggiante
	Premere il tasto <u>enter</u> per confermare il nuovo valore e passare al dato successivo
	Premere il tasto <u>menù</u> uscire dalla selezione

REGOLAZIONE ORA LEGALE

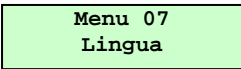
	Premere il tasto <u>menù</u> per selezionare il menù desiderato
 	Utilizzare i tasti up e down per visualizzare 
	Premere il tasto <u>enter</u> per entrare nella modalità di impostazione ora legale. Viene visualizzato 

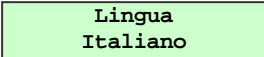
	Utilizzare i tasti  e  per modificare l'ora
	Premere il tasto <u>enter</u> per confermare il nuovo valore
	Premere il tasto <u>menù</u> per uscire dalla selezione







LINGUA





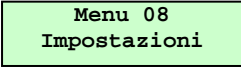

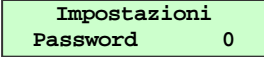

	Premere il tasto <u>menù</u> per selezionare il menù desiderato
 	Utilizzare i tasti up e down per visualizzare 
	Premere il tasto <u>enter</u> per visualizzare la lingua attualmente utilizzata. Viene visualizzato 
 	Utilizzare i tasti <u>up</u> e <u>down</u> per visualizzare la lingua desiderata
	Premere il tasto <u>enter</u> per confermare la scelta
	Premere il tasto <u>menù</u> per uscire dalla selezione

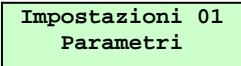
PROGRAMMAZIONE

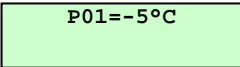
PARAMETRI

Modifica Parametri

	Premere il tasto <u>menù</u> per selezionare il menù desiderato
 	Utilizzare i tasti up e down per visualizzare 
	Premere il tasto <u>enter</u> per confermare la scelta. Viene visualizzato 
 	Utilizzare i tasti <u>up</u> e <u>down</u> per selezionare la password “-19”

	Premere il tasto <u>enter</u> per confermare la scelta. Viene visualizzato il primo sottomenù 
	Premere il tasto <u>enter</u> per per entrare nella modalità di programmazione parametri Viene visualizzato il primo parametro 
	Utilizzare i tasti <u>up</u> e <u>down</u> per scorrere tutti i parametri del controllore
	Premere il tasto <u>enter</u> per confermare la scelta
	Utilizzare i tasti <u>up</u> e <u>down</u> per selezionare il nuovo valore del parametro
	Premere il tasto <u>enter</u> per confermare la scelta
	Premere il tasto <u>menù</u> per tornare al menù principale

Descrizione Parametri

Nr.	Descrizione	Default -2/+30°C	Default -5/+30°C	Default -18/+30°C	Min	Max	Unità
Configurazioni Generali							
P1	Scelta visualizzazione a power on 0 = nessuna 1 = EVCO s.r.l.	1	1	1	0	1	---
P2	0 = Celsius 1 = Fahrenheit	0	0	0	0	1	---
P3	Offset sonda cella	0	-2	-2	-15	15	°C/°F
P4	Offset sonda evaporatore	0	0	0	-15	15	°C/°F
P5	Limite inferiore sonda umidità	0	0	0	0	P6	%
P6	Limite superiore sonda umidità	100	100	100	P5	200	%
P7	Polarità ingresso per contatto porta 0 = NO 1 = NC	0	0	0	0	1	---
P8	Polarità ingresso BT per termostato 0 = NO 1 = NC	0	0	0	0	1	---
P9	Durata Power down per ripristino programma automatico	15	15	15	1	60	minuti
P10	Scelta comportamento dopo power down per programma automatico - 0 = un ciclo automatico riparte solo se il power down è minore di P9 minuti 1 = un ciclo automatico riparte sempre	1	1	1	1	1	---
P11	Durata Power down per ripristino programma manuale	15	15	15	1	60	minuti
P12	Scelta comportamento dopo power down per programma manuale 0 = un ciclo manuale riparte solo se il power down è minore di P11 minuti 1 = un ciclo manuale riparte sempre	1	1	1	0	1	---
Setpoint							
P13	Min setpoint impostabile freddo	-2	-5	-24	-30	P14	°C/°F
P14	Max setpoint impostabile freddo	10	10	5	P13	90	°C/°F
P15	Isteresi freddo	2	2	2	1	10	°C/°F
P16	Zona morta freddo per refrigerazione, blocco e conservazione	0	0	0	0	10	°C/°F
P17	Zona morta freddo per riscaldamento, risveglio e lievitazione	0	0	0	0	10	°C/°F
P18	Zona morta freddo per climatizzazione e rallentamento	0	0	0	0	10	°C/°F
P19	Min setpoint impostabile caldo	5	5	5	0	P20	°C/°F
P20	Max setpoint impostabile caldo	30	30	30	P19	90	°C/°F







Nr.	Descrizione	Default -2/+30°C	Default -5/+30°C	Default -18/+30°C	Min	Max	Unità
P21	Isteresi caldo	1	1	1	1	10	°C/°F
P22	Zona morta caldo per riscaldamento, risveglio e lievitazione	1	1	1	0	10	°C/°F
P23	Zona morta caldo per climatizzazione e rallentamento	1	1	1	0	10	°C/°F
P24	Numero passi regolazione resistenze in risveglio	9	9	9	1	10	---
P25	Numero passi regolazione resistenze in lievitazione	1	1	1	1	10	---
Tempistiche Compresse							
P26	Ritardo tra due on successivi del compressore	3	3	3	0	60	minuti
P27	Ritardo tra un off e successivo on compressore	2	2	2	0	60	minuti
P28	Ritardo accensione compressore da power on	1	1	1	0	255	minuti
P29	Durata accensione forzata compressore ad inizio fasi di risveglio, lievitazione e rallentamento	0	0	0	0	60	minuti
Tempistiche Resistenze							
P30	Tempo minimo attivazione resistenze	0	0	0	0	255	secondi
Umidificazione e Deumidificazione							
P31	Limite inferiore temperatura cella per umidificazione/deumidificazione	5	5	5	0	90	°C/°F
P32	Modalità gestione umidità 0 = con sonda umidità 1 = a cicli di tempo in base alla percentuale impostata 2 = a passi di un minuto	0	0	0	0	2	---
P33	Tempo di pausa se P32 = 2	10	10	10	0	60	minuti
P34	Durata ciclo di umidificazione se P32 = 1	60	60	60	30	600	secondi
P35	Tempo max umidificazione se P32 = 1	30	30	30	0	P34	secondi
P36	Abilita umidificazione nelle fasi di blocco della lievitazione e conservazione 0 = disabilitata 1 = abilitata	0	0	0	0	1	---
P37	Isteresi per umidificazione	1	1	1	1	100	%
P38	Zona morta per umidificazione	4	4	4	0	100	%
P39	Banda di Regolazione Proporzionale per Umidificazione	4	4	4	0	20	%
P40	Tempo di ciclo per Reg. Prop Umidificazione	1	1	1	1	255	secondi/ minuti
P41	Base tempi per Tempo di Ciclo 0 = secondi 1 = minuti	1	1	1	0	1	---
P42	Isteresi per deumidificazione	1	1	1	1	100	%
P43	Zona morta per deumidificazione	5	5	5	0	100	%
P44	Durata Tentativo Deumidificazione con Elettrovalvola	1	1	1	1	255	secondi
Ventilazione							
P45	Abilitazione Regolazione Proporzionale Ventole Evaporatore 0 = regolazione ON/OFF 1 = regolazione proporzionale	0	0	0	0	1	---
P46	Funzionamento ventilatori evaporatore per blocco lievitazione 0 = funzionamento in parallelo 1 = funzionamento continuo	1	1	1	0	1	---
P47	Funzionamento ventilatori evaporatore per conservazione 0 = funzionamento in parallelo 1 = funzionamento continuo	1	1	1	0	1	---
P48	Funzionamento ventilatori evaporatore per risveglio 0 = funzionamento in parallelo 1 = funzionamento continuo	0	0	0	0	1	---
P49	Funzionamento ventilatori evaporatore per Lievitazione 0 = funzionamento in parallelo 1 = funzionamento continuo	0	0	0	0	1	---
P50	Funzionamento ventilatori evaporatore per rallentamento 0 = funzionamento in parallelo 1 = funzionamento continuo	0	0	0	0	1	---
P51	Funzionamento ventilatori evaporatore per refrigerazione 0 = funzionamento in parallelo 1 = funzionamento continuo	1	1	1	0	1	---
P52	Funzionamento ventilatori evaporatore per riscaldamento 0 = funzionamento in parallelo 1 = funzionamento continuo	0	0	0	0	1	---
P53	Funzionamento ventilatori per climatizzazione 0 = funzionamento in parallelo 1 = funzionamento continuo	0	0	0	0	1	---
P54	Ritardo disattivazione ventilatori evaporatore in funzionamento in parallelo	1	1	1	0	255	minuti
P55	Tempo di lavoro ventilatori evaporatore se funzionamento in parallelo	1	1	1	0	255	minuti
P56	Tempo di pausa ventilatori evaporatore se funzionamento in parallelo	1	1	1	0	255	minuti
P57	Velocità Minima Ventole Evaporatore	0	0	0	0	P58	%



Nr.	Descrizione	Default -2/+30°C	Default -5/+30°C	Default -18/+30°C	Min	Max	Unità
P58	Velocità Massima Ventole Evaporatore	100	100	100	P57	100	%
P59	Velocità Minima Ventole Evaporatore durate deumidificazione	20	20	20	P57	P58	%
Sbrinamento							
P60	Temperatura Evaporatore per fine sbrinamento	8	8	8	-40	99	°C
P61	Intervallo tra due sbrinamenti successivi 0 = lo sbrinamento non si ripete	8	8	6	0	10	ore
P62	Durata massima ciclo di sbrinamento	10	10	30	1	120	minuti
P63	Tempo di sgocciolamento	2	2	3	0	30	minuti
P64	Stato ventole durante lo sbrinamento	0	0	0	0	1	---
P65	Durata blocco ventole dopo sgocciolamento	2	2	2	0	15	minuti
Raffreddamento							
P66	Minimo Setpoint per Raffreddamento	-2	-5	-5	-30	P67	°C
P67	Massimo Setpoint per Raffreddamento	10	10	10	P66	30	°C
P68	Preset Raffreddamento	-2	-5	-5	P66	P67	°C
Impostazione e Modifica Programmi							
P69	Abilitazione Impostazione Programmi	1	1	1	0	1	---
P70	Abilitazione Modifica Programmi	1	1	1	0	1	---
P71	Gestione K3: 0=ElettroValvola; 1= Luce; 2 = Deumidificazione	1	1	1	0	2	---
P72	Gestione Compressore con Porta Aperta: 0 = nessun effetto; 1= spegne compressore	0	0	0	0	1	---
P73	Tipo sbrinamento: 0 = Resistenza; 1 = Gas Caldo	0	0	0	0	1	---
P74	Allarme alta temperatura Evaporatore	55	55	55	0	70	°C
P75	Abilita allarme alta temperatura Evaporatore: 0= non abilitato; 1= abilitato	1	1	1	0	1	---
P76	Abilitazione della Deumidificazione 0= disabilitata 1= abil. in Risveglio, Lievitazione, Rallentamento, Climatizzazione, Riscaldamento 2=abilitata anche in Blocco e Conservazione	0	0	0	0	2	---
P77	Tempo Resistenza ON	3	3	3	1	255	secondi/ minuti
P78	Tempo Resistenza OFF (0= resistenze sempre accese)	1	1	1	0	255	secondi/ minuti

Nota











- Controllare i tempi di protezione del compressore in quanto di default sono impostati a zero.
- I parametri P5 e P6 sono utilizzati per definire il range della sonda umidità. Il parametro P5 deve essere posto uguale alla percentuale di umidità corrispondente a 4mA e il parametro P6 deve essere posto uguale alla percentuale di umidità corrispondente a 20mA.
- Dopo una modifica al parametro P32 verificare il setpoint di umidità dei programmi automatici e manuale.

INGRESSI/USCITE

	Premere il tasto <u>menù</u> per selezionare il menù desiderato
	Utilizzare i tasti up e down per visualizzare Menu 08 Impostazioni
	Premere il tasto <u>enter</u> per confermare la scelta. Viene visualizzato Impostazioni Password 0
	Utilizzare i tasti <u>up</u> e <u>down</u> per selezionare la password “-19”
	Premere il tasto <u>enter</u> per confermare la scelta. Viene visualizzato il primo sottomenù Impostazioni 01 Parametri
	Utilizzare i tasti up e down per visualizzare Impostazioni 02 Ingressi/Uscite
	Premere il tasto <u>enter</u> per per entrare nella modalità di visualizzazione ingressi e uscite Viene visualizzato Cella -6°C Evapor -15°C

 	<p>Utilizzare i tasti <u>up</u> e <u>down</u> per scorrere le grandezze da visualizzare</p> <table border="1" data-bbox="416 241 660 297"> <tr><td>Cella</td><td>-6°C</td></tr> <tr><td>Evapor</td><td>15°C</td></tr> </table> <p>Valore delle temperature di Cella ed Evaporatore</p> <table border="1" data-bbox="416 309 660 365"> <tr><td>Umidita</td><td>14%</td></tr> </table> <p>Valore sonda Umidità</p> <table border="1" data-bbox="416 376 660 432"> <tr><td>C</td><td>D</td><td>E</td><td>R</td><td>V</td><td>H</td><td>U</td></tr> <tr><td>1</td><td>0</td><td>0</td><td>1</td><td>1</td><td>0</td><td>0</td></tr> </table> <p>Stato delle uscite 1 = relè attivato 0 = relè disattivato</p> <table border="1" data-bbox="416 454 660 510"> <tr><td>DI1</td><td>DI2</td><td>FAN</td></tr> <tr><td>0</td><td>1</td><td>98</td></tr> </table> <p>Stato degli ingressi digitali e velocità della ventola evaporatore</p> <table border="1" data-bbox="1046 320 1441 398"> <tr><td>C</td><td>Compressore</td><td>V</td><td>Ventole</td></tr> <tr><td>D</td><td>Defrost</td><td>H</td><td>Gen vapore</td></tr> <tr><td>EV</td><td>Luce Deum</td><td>U</td><td>Umidificatore</td></tr> <tr><td>R</td><td>Resistenze</td><td></td><td></td></tr> </table>	Cella	-6°C	Evapor	15°C	Umidita	14%	C	D	E	R	V	H	U	1	0	0	1	1	0	0	DI1	DI2	FAN	0	1	98	C	Compressore	V	Ventole	D	Defrost	H	Gen vapore	EV	Luce Deum	U	Umidificatore	R	Resistenze		
Cella	-6°C																																										
Evapor	15°C																																										
Umidita	14%																																										
C	D	E	R	V	H	U																																					
1	0	0	1	1	0	0																																					
DI1	DI2	FAN																																									
0	1	98																																									
C	Compressore	V	Ventole																																								
D	Defrost	H	Gen vapore																																								
EV	Luce Deum	U	Umidificatore																																								
R	Resistenze																																										
	<p>Premere il tasto <u>menù</u> per tornare al menù principale</p>																																										

RIPRISTINO PARAMETRI DI DEFAULT



	<p>Premere il tasto <u>menù</u> per selezionare il menù desiderato</p>		
 	<p>Utilizzare i tasti <u>up</u> e <u>down</u> per visualizzare</p> <table border="1" data-bbox="962 857 1203 925"> <tr><td>Menu 08</td></tr> <tr><td>Impostazioni</td></tr> </table>	Menu 08	Impostazioni
Menu 08			
Impostazioni			
	<p>Premere il tasto <u>enter</u> per confermare la scelta. Viene visualizzato</p> <table border="1" data-bbox="683 1008 949 1064"> <tr><td>Impostazioni</td></tr> <tr><td>Password 0</td></tr> </table>	Impostazioni	Password 0
Impostazioni			
Password 0			
 	<p>Utilizzare i tasti <u>up</u> e <u>down</u> per selezionare la password “-19”</p>		
	<p>Premere il tasto <u>enter</u> per confermare la scelta. Viene visualizzato il primo sottomenù</p> <table border="1" data-bbox="903 1243 1144 1310"> <tr><td>Impostazioni 01</td></tr> <tr><td>Parametri</td></tr> </table>	Impostazioni 01	Parametri
Impostazioni 01			
Parametri			
 	<p>Utilizzare i tasti <u>up</u> e <u>down</u> per visualizzare</p> <table border="1" data-bbox="948 1330 1189 1397"> <tr><td>Impostazioni 03</td></tr> <tr><td>Ripristino</td></tr> </table>	Impostazioni 03	Ripristino
Impostazioni 03			
Ripristino			
	<p>Premere il tasto <u>enter</u> per accedere alla richiesta di cancellazione dei dati registrati in memoria. Viene visualizzato</p> <table border="1" data-bbox="657 1473 898 1541"> <tr><td>Ripristino?</td></tr> <tr><td>No Si</td></tr> </table>	Ripristino?	No Si
Ripristino?			
No Si			











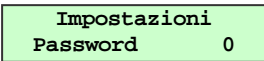



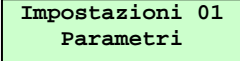

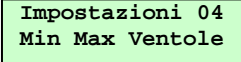
Premere il tasto  per uscire dal menu e non effettuare nessun ripristino.

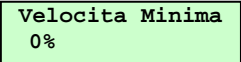
Premere il tasto  per ripristinare i parametri originali di default.

Premere il tasto  per tornare al menù principale

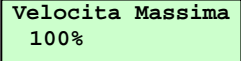
REGOLAZIONE VELOCITA' VENTOLE

	<p>Premere il tasto <u>menù</u> per selezionare il menù desiderato</p>		
 	<p>Utilizzare i tasti <u>up</u> e <u>down</u> per visualizzare</p> <table border="1" data-bbox="962 1946 1203 2013"> <tr><td>Menu 08</td></tr> <tr><td>Impostazioni</td></tr> </table>	Menu 08	Impostazioni
Menu 08			
Impostazioni			

	<p>Premere il tasto <u>enter</u> per confermare la scelta.</p> <p>Viene visualizzato </p>
 	<p>Utilizzare i tasti <u>up</u> e <u>down</u> per selezionare la password “-19”</p>
	<p>Premere il tasto <u>enter</u> per confermare la scelta.</p> <p>Viene visualizzato il primo sottomenù </p>
 	<p>Utilizzare i tasti up e down per visualizzare </p>
	<p>Premere il tasto <u>enter</u> per per entrare nella modalità di regolazione della velocità delle ventole.</p> <p>Viene visualizzato </p>
	<p>Premere il tasto <u>enter</u> per entrare in modifica. Il valore diventa lampeggiante.</p> <p>Utilizzare i tasti  e  per modificare il valore.</p>
	<p>Premere il tasto <u>enter</u> per confermare il nuovo valore.</p> <p>Viene visualizzato </p> <p>Utilizzare i tasti  e  per modificare il valore.</p>
	<p>Premere il tasto <u>enter</u> per confermare il nuovo valore.</p>
	<p>Premere il tasto <u>menù</u> per tornare al menù principale</p>

ALLARMI E SEGNALAZIONI

Sono presenti segnalazioni visive e sonore in caso di malfunzionamenti.

Sonda Cella

Un guasto della sonda provoca un Allarme della Sonda Cella, il buzzer suona e sul display lampeggia la scritta di errore:

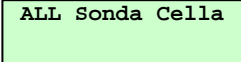

Qualsiasi ciclo in corso viene bloccato e tutte le uscite disattivate.

Il buzzer si può tacitare premendo un qualsiasi tasto.

Alla scomparsa dell'errore riprende il ciclo.

Termostato di sicurezza

Quando l'allarme del Termostato viene rilevato dalla scheda, il buzzer suona e sul display compare la visualizzazione di allarme:

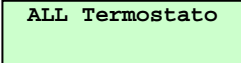

Qualsiasi ciclo in corso viene bloccato e tutte le uscite sono disattivate.

Il buzzer si può tacitare premendo un qualsiasi tasto.

Alla scomparsa dell'errore premere il tasto  per riarmare la scheda.

Sonda evaporatore

Un guasto della sonda provoca un Allarme guasto della Sonda Evaporatore, il buzzer suona e sul display lampeggia la scritta di allarme:

ALL Sonda Evap

Qualsiasi ciclo in corso viene bloccato e tutte le uscite disattivate.
Il buzzer si può tacitare premendo un qualsiasi tasto.
Alla scomparsa dell'errore riprende il ciclo.

Alta temperatura Evaporatore

Quando la Sonda Evaporatore raggiunge il valore impostato nel parametro *P74*, si attiva l'allarme di alta temperatura dell'Evaporatore. Il buzzer suona e sul display lampeggia la scritta di allarme:

ALL Alta T Evap

Qualsiasi ciclo in corso viene bloccato e tutte le uscite disattivate.
Il buzzer si può tacitare premendo un qualsiasi tasto.

Alla scomparsa dell'errore premere il tasto  per riarmare la scheda.

Sonda Umidità

Un guasto della sonda provoca un Allarme guasto della Sonda Umidità, il buzzer suona e sul display lampeggia la scritta di allarme:

ALL Sonda Umidita

Qualsiasi ciclo in corso viene bloccato e tutte le uscite disattivate.
Il buzzer si può tacitare premendo un qualsiasi tasto.
Alla scomparsa dell'errore riprende il ciclo.

MicroPorta

Ogni apertura della porta viene segnalata con la scritta Porta Aperta lampeggiante:

Porta Aperta

L'apertura della porta durante un ciclo di abbattimento, ferma le Ventole, le Resistenze e l'Umidificatore; il Compressore e il Generatore di Vapore rimangono accesi.

Il buzzer suona, ma può essere tacitato premendo un tasto qualsiasi e la segnalazione rientra automaticamente alla chiusura della porta.

Ad ogni apertura della Porta si accende la Luce.

Malfunzionamento RTC

Qualora si rilevi un malfunzionamento dell'RTC, viene segnalato un allarme di RTC; il buzzer suona e sul display lampeggia la scritta di allarme:

ALL RTC

Qualsiasi ciclo in corso viene bloccato e tutte le uscite disattivate.
Il buzzer si può tacitare premendo qualsiasi tasto.

È possibile andare nel Menu impostazione Orologio e settare i valori correnti dell'RTC; dopo la scheda torna in standby.

Allarme EEPROM

Qualora si rilevi incoerenza nei dati memorizzati in Eeprom, viene segnalato un allarme di Eeprom; il buzzer suona e sul display lampeggia la scritta di allarme:

ALL EEprom

Qualsiasi ciclo in corso viene bloccato e tutte le uscite disattivate.

Il buzzer si può tacitare premendo qualsiasi tasto.

Per riarmare la scheda premere il tasto . Dopo il riarmo la scheda torna in standby.

NB: dopo un allarme Eeprom tutti i parametri vengono ripristinati al valore di default.

IRREGOLARITA' DI FUNZIONAMENTO

In caso di funzionamento irregolare, prima di interpellare il servizio assistenza di zona, verificare che:

la scheda comandi sia accesa e che ci sia tensione in rete; (63)

il valore della temperatura impostata sia quello desiderato; (65)

la porta sia perfettamente chiusa;

l'apparecchio non sia posto vicino a fonti di calore; (38)

il condensatore sia pulito e il ventilatore funzioni regolarmente;

non vi sia un'eccessiva brinatura sulla batteria evaporante.

Se detti controlli abbiano dato esito negativo, rivolgersi al servizio assistenza di zona fornendo indicazioni sul modello, numero di serie e matricola riportati sulla targhetta caratteristiche, posta sul cruscotto dell'apparecchio. (11)

PULIZIA GIORNALIERA

Per garantire una perfetta igiene e conservazione dell'apparecchio (66) è bene effettuare ordinariamente e/o giornalmente le operazioni di pulizia come di seguito indicato:

Pulire accuratamente le superfici esterne dell'apparecchio passandole con una spugna morbida immersa in acqua e detersivo neutro, e strizzata, unicamente nel senso della satinatura. (67)

Il detersivo non deve contenere cloro e non deve essere abrasivo. (67)

I detersivi consigliati sono quelli del tipo:

Detersivo disinfettante ad azione combinata; (contenente tensioattivi non ionici, benzalconio cloruro, sostanze chelanti e pH tampone)

Detersivo per laboratorio, neutro, per lavaggio manuale; (contenente tensioattivi anionici e non ionici)

Sgrassante per ambienti alimentari; (contenente tensioattivi anionici ed EDTA)

Prima dell'uso diluire eventualmente i detersivi secondo le istruzioni riportate in etichetta.

Lasciare agire i detersivi per almeno 5 minuti.

Risciacquare accuratamente le pareti dell'apparecchio con una spugna passata più volte in acqua corrente. (69)

Asciugare con cura utilizzando una spugna pulita.

ATTENZIONE: non usare nel modo più assoluto utensili o corpi che possono produrre incisioni con la conseguente formazione di ruggine. (68)

Eliminare eventuali presenze all'interno dell'apparecchio di macchie di cibo o residui (vedi paragrafo successivo).

MACCHIE DI CIBO E RESIDUI INDURITI

In caso di presenza nell'apparecchio di macchie da cibo o residui lavare con acqua ed asportarli prima che questi possano indurire.

Se i residui sono già induriti procedere come segue:

Usare una spugna morbida immersa in acqua tiepida e detersivo neutro (si possono usare quelli previsti per la pulizia giornaliera, alla concentrazione più alta tra quelle previste in etichetta). (72)

Inumidire il residuo indurito in modo da mantenerlo umido per almeno 30 minuti ripassando ogni circa 5 minuti la spugna immersa in acqua e detersivo sullo sporco indurito.

Alla fine dell'ammollo asportare il residuo con la spugna immersa in acqua e detersivo neutro.

Se occorre, ricorrere ad una spatola di legno o a paglietta fine di acciaio inox, avendo cura di non danneggiare la superficie dell'apparecchio. (70)

Al termine del procedimento si consiglia un ciclo di pulizia giornaliera di tutte le superfici interne dell'apparecchio.

A pulizia ultimata risciacquare accuratamente con una spugna passata più volte in acqua corrente.

Asciugare con cura utilizzando una spugna pulita.

Anche le zone sottostanti e adiacenti devono essere pulite e mantenute in perfetta igiene.

Pulire con acqua e sapone o detergente neutro. (71)

Proteggere le lamiere con cera ai siliconi.

PULIZIA E MANUTENZIONE PERIODICA

Per un costante rendimento dell'apparecchio è bene compiere le operazioni di pulizia e manutenzioni periodiche.

Prima di iniziare con le operazioni procedere come segue:

portare l'interruttore generale nella posizione OFF (16)

togliere la spina dalla presa e attendere che sia avvenuto il completo sbrinamento dell'apparecchio. (17)

Con una aspirapolvere, un pennello o una spazzola non metallica pulire con cura il condensatore del gruppo refrigerante e l'evaporatore dopo aver tolto le protezioni. (73)

ATTENZIONE: La pulizia e la manutenzione dell'impianto refrigerante e della zona compressori richiede l'intervento di un tecnico specializzato e autorizzato, per questo motivo non può essere effettuato da personale non idoneo. (30)

Pulire le superfici esterne ed interne dell'apparecchio seguendo le indicazioni riportate nel paragrafo pulizia giornaliera.

Gli apparecchi a temperatura positiva "NORMALE TEMPERATURA" sono provvisti di un foro di lavaggio nella parte inferiore del vano.

Verificare che il foro non sia ostruito ed eventualmente pulirlo. (75)

Dopo aver aperto il pannello di chiusura del kit generatore vapore, smontare il tubo vapore e decalcificarlo utilizzando acqua corrente. Disassemblare il boiler dal kit e decalcificarlo utilizzando acqua corrente.

Riassemblare il tutto. (76a)

A questo punto le operazioni di manutenzione e pulizia generali sono terminate.

INTERRUZIONI D'USO

In caso di prolungata inattività dell'apparecchio e per mantenerlo nelle migliori condizioni operare come segue:

portare l'interruttore di rete in posizione OFF. (16)

togliere la spina dalla presa. (17)

vuotare l'apparecchio e pulirlo come descritto al capitolo "PULIZIA". (76)

svuotare l'acqua presente nel boiler generatore vapore dopo aver tolto la fascetta serratubo e sfilato il tubo. (76a)

lasciare le porte delle celle socchiuse per evitare la formazione di cattivi odori. (77)

coprire il gruppo compressore con un telo in nylon per proteggerlo dalla polvere. (78)

CONSIGLI UTILI PER LA MANUTENZIONE DELL'ACCIAIO INOSSIDABILE

Gli apparecchi sono costruiti in acciaio INOX AISI 304. (79)

Per la pulizia e manutenzione delle parti costruite in acciaio inossidabile, attenersi a quanto di seguito specificato, tenendo presente che la prima e fondamentale regola è di garantire la non tossicità e la massima igiene dei prodotti trattati.

L'acciaio inossidabile ha un sottile strato di ossido che impedisce la formazione di ruggine.

Ci sono sostanze o detersivi che però possono distruggere o intaccare questo strato e dare così origine a corrosioni.

Prima di usare qualsiasi prodotto detergente informatevi sempre presso il vostro fornitore di fiducia quale è il tipo più adatto di detergente neutro che non provoca corrosioni sull'acciaio. (73)

In caso di graffi sulle superfici è necessario levigarle con lana di ACCIAIO INOX finissima o spugnette abrasive di materiale sintetico fibroso strofinando nel senso della satinatura. (80)

ATTENZIONE: Per la pulizia dell'ACCIAIO INOX non usare mai pagliette di ferro e non lasciarle appoggiate sopra alle superfici in quanto i depositi ferrosi molto piccoli potrebbero rimanere sulle superfici e provocare formazione di ruggine per contaminazione e compromettere lo stato d'igiene. (81)

PROBLEMI DI FUNZIONAMENTO

Spesso le difficoltà di funzionamento che si possono verificare sono dovute a cause quasi sempre rimediabili senza l'intervento di un tecnico specializzato. Quindi prima di segnalare un guasto alla rete di assistenza verificare quanto segue:

PROBLEMA	POSSIBILI CAUSE
L'apparecchiatura non si accende	Controllare che la spina sia inserita nella presa di corrente
	Controllare che alla presa arrivi corrente
La temperatura interna è troppo elevata	Verificare la regolazione della scheda elettronica
	Verificare che non ci sia influenza di una fonte di calore
	Verificare che la porta chiuda perfettamente
L'apparecchio è eccessivamente rumoroso	Verificare il livellamento dell'apparecchiatura. Una posizione non equilibrata potrebbe innescare delle vibrazioni
	Controllare che l'apparecchiatura non sia a contatto con altre apparecchiature o parti che potrebbero entrare in risonanza
All'interno dell'apparecchio ci sono odori sgradevoli	Ci sono alimenti dall'odore particolarmente forte (ad esempio formaggio e melone), in contenitori non sigillati
	Le superfici interne devono essere pulite
Sull'apparecchiatura si forma della condensa	L'umidità ambiente è molto elevata
	Non si sono chiusi bene gli sportelli

Eseguite le verifiche suddette, se il difetto persiste, rivolgetevi all'assistenza tecnica ricordandoVi di segnalare:

la natura del difetto

il modello ed il numero di matricola dell'apparecchio che si possono rilevare dalla targa delle caratteristiche elettriche, posta sotto il cruscotto dell'apparecchiatura.

SMALTIMENTO RIFIUTI E DISMISSIONE

STOCCAGGIO RIFIUTI

Alla fine del ciclo di vita del prodotto, non disperdere nell'ambiente l'apparecchiatura. Le porte dovranno essere smontate prima dello smaltimento dell'apparecchiatura.

E' ammesso uno stoccaggio provvisorio di rifiuti speciali in vista di uno smaltimento mediante trattamento e/o stoccaggio definitivo. Vanno comunque osservate le leggi vigenti nel paese dell'utilizzatore in materia di tutela dell'ambiente.

PROCEDURA SMONTAGGIO APPARECCHIATURA

Nei vari Paesi sono in vigore legislazioni differenti, pertanto si devono osservare le prescrizioni imposte dalle leggi e dagli enti preposti dai Paesi dove avviene la demolizione.

In generale è necessario riconsegnare l'apparecchio ai centri specializzati per la raccolta e demolizione.

Smontare l'apparecchio raggruppando i componenti secondo la loro natura chimica, ricordando che nel compressore vi è olio lubrificante e fluido refrigerante, che possono essere recuperati e riutilizzati e che i componenti del frigorifero sono rifiuti speciali assimilabili agli urbani.

Rendere inutilizzabile l'apparecchiatura per lo smaltimento rimuovendo il cavo di alimentazione e qualsiasi dispositivo di chiusura vani per evitare che qualcuno possa rimanere chiuso al suo interno.

LE OPERAZIONI DI SMONTAGGIO DEVONO ESSERE ESEGUITE DA PERSONALE QUALIFICATO.

SICUREZZA PER LO SMALTIMENTO DI RIFIUTI DI APPARECCHIATURE ELETTRICHE ED ELETTRONICHE (DIRETTIVA RAEE 2002/96)

Non disperdere materiale inquinante nell'ambiente. Effettuare lo smaltimento nel rispetto delle leggi vigenti in materia.

In riferimento alla direttiva RAEE 2002/96 (Rifiuti di Apparecchiature Elettriche ed Elettroniche), l'utilizzatore, in fase di dismissione, deve smaltire le apparecchiature negli appositi centri di raccolta autorizzati, oppure riconsegnarli ancora installati al venditore all'atto di un nuovo acquisto.

Tutte le apparecchiature, che devono essere smaltite secondo la direttiva RAEE 2002/96, sono contrassegnate da un apposito simbolo (12)

Lo smaltimento abusivo dei Rifiuti di Apparecchiature Elettriche ed Elettroniche è punito con sanzioni regolate dalle leggi vigenti nel territorio in cui viene accertata l'infrazione.

I Rifiuti di Apparecchiature Elettriche ed Elettroniche possono contenere sostanze pericolose con effetti potenzialmente nocivi sull'ambiente e sulla salute delle persone. Si raccomanda di effettuare lo smaltimento in modo corretto.

INVERSIONE PORTA(82)

Gli apparecchi sono forniti di serie con apertura destra.

Nella trasformazione con incernieratura sinistra, si dovrà operare come segue:

Ruotare il cruscotto sulle testate laterali rimuovendo la vite "F".

Svitare le due viti di fissaggio della staffa "A" e la vite "ferma" cerniera "B".

Rimuovere la porta e smontare la cerniera "B" e il componente "E", invertendo il loro montaggio.

Smontare il componente "C" adattandolo sul lato opposto della porta.

Smontare la staffa inferiore "D" rimontandola sul lato opposto nella sede predisposta.

Posizionare la porta introducendo il foro del componente inferiore "E" sul perno della staffa "D".

Fissare la staffa "A" alla struttura sul lato opposto, avvitando a fondo le viti di fissaggio.

Prima del serraggio delle viti delle staffe, verificare la quota d'incernieramento che deve essere circa 12mm, e la perpendicolarità della porta rispetto alla struttura.

Spostare il micro presente sul cruscotto dalla parte opposta, utilizzando i fori predisposti.

Riposizionare il cruscotto inserendo la vite "F".

NOTA: Le operazioni di smontaggio staffe e rimontaggio vanno eseguite con porta chiusa.

SCHEDA TECNICA DEL REFRIGERANTE

R404A :componenti del fluido

trifluoroetano	(HFC 143a)	52%
pentafluoroetano	(HFC 125)	44%
tetrafluoroetano	(HFC 134a)	4%

GWP = 3750

ODP = 0

Identificazione dei pericoli

Elevate esposizioni per inalazione possono provocare effetti anestetici.

Esposizioni molto elevate possono causare anomalie del ritmo cardiaco e provocare morte improvvisa. Il prodotto nebulizzato o sotto forma di schizzi può provocare ustioni da gelo agli occhi o alla pelle.

Misure di primo soccorso

• Inalazione:

allontanare l'infortunato dall'esposizione, e tenerlo al caldo e a riposo. Se necessario somministrare ossigeno. Praticare la respirazione artificiale se la respirazione si è arrestata o dà segni di arrestarsi. In caso di arresto cardiaco effettuare massaggio cardiaco esterno. Richiedere assistenza medica immediata.

• Contatto con la pelle:

far sgelare con acqua le zone interessate. Togliere gli indumenti contaminati.

ATTENZIONE : gli indumenti possono aderire alla pelle in caso di ustioni da gelo.

In caso di contatto con la pelle, lavarsi immediatamente e abbondantemente con acqua tiepida. Se si verificano sintomi (irritazione o formazione di vesciche) richiedere assistenza medica

- Contatto con gli occhi:

lavare immediatamente con soluzione per lavaggio oculare o acqua pulita, tenendo scostate le palpebre, per almeno 10 minuti. Richiedere assistenza medica.

- Ingestione:

può provocare il vomito. Se l'infortunato è cosciente, far sciacquare la bocca con acqua e far bere 200-300ml d'acqua. Richiedere immediata assistenza medica.

- Ulteriori cure mediche:

trattamento sintomatico e terapia di supporto quando indicato. Non somministrare adrenalina e farmaci *simpaticomimetici similari in seguito ad esposizione, per rischio di aritmia cardiaca con possibile arresto cardiaco.

Informazioni ecologiche

Persistenza e degradazione

- HFC 143a:

si decompone lentamente nell'atmosfera inferiore (troposfera). La durata nell'atmosfera è 55 anni.

- HFC 125:

si decompone lentamente nell'atmosfera inferiore (troposfera). La durata nell'atmosfera è 40 anni.

- HFC 134a:

si decompone con relativa rapidità nell'atmosfera inferiore (troposfera). La durata nell'atmosfera è 15,6 anni.

- HFCs 143a, 125, 134a:

non influenza lo smog fotochimico (cioè non rientra tra i componenti organici volatili -VOC- secondo quanto stabilito dall'accordo UNECE). Non provoca la rarefazione dell'ozono.

Gli scarichi di prodotto rilasciati nell'atmosfera, non provocano contaminazione delle acque a lungo termine.

LO SCHEMA ELETTRICO È RIPORTATO NELL'ULTIMA PAGINA DEL LIBRETTO

POS	DESCRIZIONE	POS	DESCRIZIONE
1	GRUPPO COMPRESSORE	44	RELÉ DI POTENZA COMPRESSORE
2	VENTILATORE CONDENSATORE	44A	RELE' PTC EVAP. CONDENSA
3	MORSETTIERA	44B	RELE' MICROINTERRUTTORE MAGNETICO
6	INTERRUTTORE GENERALE CON SPIA	56	FILTRO ANTIDISTURBO LAMP.NEON
8	SPINA ELETTRICA	69	MORSETTO DI TERRA
9	VENTILATORE EVAPORATORE	70	PRESSOSTATO DI SICUREZZA ALTA PRESS.
9A	VENTILATORE EVAPORATORE	75	ELETTROVALVOLA DI MANDATA
9B	VENTILATORE EVAPORATORE	76	MICROINTERRUTTORE MAGNETICO
10	LAMPADA INTERNA VANO	85	SCATOLA DERIVAZIONE
10A	LAMPADA INTERNA VANO	86	SONDA CONDENSATORE
12	ELETTROVALVOLA SBRINAMENTO	90	TERMOREGOLATORE DIGITALE
14	DEVIATORE DOPPIA UMIDITA'	91	RESISTENZA PTC
15	MICRO INTERRUTTORE VENTOLE	96	SCHEDA FRIGO LCD
15A	MICRO INTERRUTTORE VENTOLE	101	RESISTENZA ANTIC.CAPPUCCIO
18	SPIA DI SICUREZZA	102	TERMOSTATO BIMETALLICO DI SICUREZZA
19	TERMOSTATO DI SICUREZZA	103	SONDA DI UMIDITA'
20	RESISTENZA ANTICONDENSA PORTA	104	REGOLATORE DI LIVELLO
20A	RESISTENZA ANTICONDENSA PORTA	105	SONDA DI LIVELLO
21	RESISTENZA DI SBRINAMENTO	106	TERMOSTATO DI SICUREZZA GENERATORE DI VAPORE
22	RESISTENZA FONDO BACINELLA	107	RESISTENZA ELETTRICA CAMERA
25	TRASFORMATORE DI TENSIONE	108	RESISTENZA GENERATORE DI VAPORE
28	INTERRUTTORE LAMPADA NEON	109	SCHEDA QUADRO FERMALIEVITAZIONE
29	REATTORE LAMPADA NEON	110	SCHEDA COMANDI FERMALIEVITAZIONE
30	STARTER LAMPADA NEON	111	SCHEDA ESPANSIONE RELE' FERMALIEVITA
31	LAMPADA NEON	112	ELETTROVALVOLA ACQUA UMIDIFICAZIONE

INFORMAZIONE EX ART. 13 del Decreto Legislativo n. 151 del 25 luglio 2005.

- a) E' fatto obbligo di non smaltire i RAEE (Rifiuti di Apparecchiature Elettriche ed Elettroniche) come rifiuti urbani e di effettuare per detti rifiuti, una raccolta separata.
- b) La raccolta RAEE viene effettuato attraverso un Consorzio che svolge, a seguito di autorizzazione amministrativa, detto servizio. Il cliente, all'atto dell'acquisto di una apparecchiatura AEE (Apparecchiature Elettriche ed Elettroniche) nuova, nella sussistenza del concorso delle condizioni di cui all'art. 12 del Decreto Legislativo n. 151 del 25 luglio 2005, n.1, 2 e 3, potrà chiedere il ritiro di quella equivalente posseduta, a meno che non si tratti di AEE usate e di cui alla lettera c) dell'art. 3 del citato decreto legislativo.
- c) La dispersione nell'ambiente dei RAEE, o di parti di essi, provoca effetti inquinanti e dannosi alla salute umana per la presenza in detta apparecchiature di sostanze pericolose dall'uso improprio delle quali possono derivare gravi danni alle cose e alle persone.
- d) Il simbolo del bidone barrato, sotto riprodotto, apposto sulla presente apparecchiatura, indica che la stessa è stata posta sul mercato dopo il 13.8.2005 e che deve essere oggetto di raccolta separata.



- e) In caso di smaltimento abusivo di RAEE sono previste le seguenti sanzioni: 1. Il distributore che, nell'ipotesi di cui all'articolo 6, comma 1, lettera b), indebitamente non ritira, a titolo gratuito, una apparecchiatura elettrica od elettronica, è punito con la sanzione amministrativa pecuniaria da euro 150 ad euro 400, per ciascuna apparecchiatura non ritirata o ritirata a titolo oneroso. 2. Il produttore che non provvede ad organizzare il sistema di raccolta separata dei RAEE professionali di cui all'articolo 6, comma 3 ed i sistemi di ritiro ed invio, di trattamento e di recupero dei RAEE di cui agli articoli 8, comma 1, e 9, comma 1, ed a finanziare le relative operazioni, nelle ipotesi e secondo le modalità di cui agli articoli 10, comma 1, 11, comma 1 e 12, commi 1, 2 e 3. fatti salvi, per tali ultime operazioni, gli accordi eventualmente conclusi ai sensi dell'articolo 12, comma 6, è punito con la sanzione amministrativa pecuniaria da euro 30.000 ad euro 100.000. 3. Il produttore che, dopo il 13 agosto 2005, nel momento in cui immette una apparecchiatura elettrica od elettronica sul mercato, non provvede a costituire la garanzia finanziaria di cui agli articoli 11, comma 2, o 12, comma 4, è punito con la sanzione amministrativa pecuniaria da euro 200 ad euro 1.000 per ciascuna apparecchiatura immessa sul mercato. 4. Il produttore che non fornisce, nelle istruzioni per l'uso di AEE, le informazioni di cui all'articolo 13, comma 1, è punito con la sanzione amministrativa pecuniaria da euro 2.000 ad euro 5.000. 5. Il produttore che, entro un anno dalla immissione sul mercato di ogni tipo di nuova AEE, non mette a disposizione dei centri di reimpiego e degli impianti di trattamento e di riciclaggio le informazioni di cui all'articolo 13, comma 3, è punito con la sanzione amministrativa pecuniaria da euro 5.000 ad euro 30.000. 6. Il produttore che, dopo il 13 agosto 2005, immette sul mercato AEE prive della indicazione o del simbolo di cui all'articolo 13, commi 4 e 5, è punito con la sanzione amministrativa pecuniaria da euro 200 ad euro 1000 per ciascuna apparecchiatura immessa sul mercato. La medesima sanzione amministrativa pecuniaria si applica nel caso in cui i suddetti indicazione o simbolo non siano conformi ai requisiti stabiliti all'articolo 13, commi 4 e 5. 7. Il produttore che, senza avere provveduto alla iscrizione presso la Camera di commercio ai sensi dell'articolo 14, comma 2, immette sul mercato AEE, è punito con la sanzione amministrativa pecuniaria da euro 30.000 ad euro 100.000. 8. Il produttore che, entro il termine stabilito col decreto di cui all'articolo 13, comma 8, non comunica al Registro nazionale dei soggetti obbligati allo smaltimento dei RAEE le informazioni di cui all'articolo 13, commi 6 e 7, ovvero le comunica in modo incompleto o inesatto, è punito con la sanzione amministrativa pecuniaria da euro 2.000 ad euro 20.000. 9. Fatte salve le eccezioni di cui all'articolo 5, comma 2, chiunque, dopo il 1° luglio 2006, immette sul mercato AEE nuove contenenti le sostanze di cui all'articolo 5, comma 1 o le ulteriori sostanze individuate ai sensi dell'articolo 18, comma 1, è punito con la sanzione amministrativa pecuniaria da euro 50 ad euro 500 per ciascuna apparecchiatura immessa sul mercato oppure da euro 30.000 ad euro 100.000.

INDEX

DESCRIPTION DE LA MACHINE	2
ACCESSOIRES	2
PLAQUETTE D'IDENTIFICATION	2
NOTE GENERALES A LA REMISE	3
PRESCRIPTION DE SECURITE	3
PRESCRIPTIONS HACCP	4
CARACTERISTIQUES TECHNIQUES	4
MESE EN OEUVRE ET INSTALLATION	4
TABLEUX DE COMMANDE	6
MISE EN MARCHE	7
CHARGEMENT DU PRODUIT	7
FONCTIONNEMENT CYCLE MANUEL - CYCLE AUTOMATIQUE	7
ARRET	12
DEGIVRAGE	12
REGLAGE HORLOGE	13
REGLAGE HEURE LEGALE	13
LANGUE	14
PROGRAMMATION	14
ALARMS	19
IRREGULARITES DE FONCTIONNEMENT	21
NETTOYAGE JORNALIER	21
TACHES DE NOURRITURE ET RESTES RACORNIS	22
NETTOYAGE ET ENTRETIEN PERIODIQUE	22
INTERRUPTIONS D'USAGE	23
CONSEILS UTILES POUR L'ENTRETIEN DE L'ACIER INOX	23
PROBLEMES DE FONCTIONNEMENT	23
DÉMOLITION ET ÉLIMINATION DES DÉCHETS	24
INVERSION PORTE	24
FICHE TECHNIQUE DU REFRIGERANT	25

DESCRIPTION DE LA MACHINE

Cet appareillage a été conçu pour la réfrigération, le réchauffement et la conservation des aliments. Toute autre utilisation est considérée comme étant impropre.

ATTENTION : les appareils ne sont pas prévus pour être installés à l'extérieur et/ou en endroits soumis à l'action d'agents atmosphériques.

Le fabricant décline toute responsabilité en cas d'utilisations non consenties de l'appareil.

Les appareillages sont disponibles avec portes en acier.

Les appareillages sont réalisés avec installation de réfrigération à "TEMPERATURE NORMALE" et "TEMPERATURE BASSE" pour satisfaire la conservation des aliments à des températures différentes. (1)

Les appareillages sont dotés d'un évaporateur à ailette protégé contre l'oxydation, d'un compresseur hermétique, d'un condensateur en cuivre-aluminium, d'un kit d'humidification, d'une résistance interne, d'une sonde humidité et d'un panneau de commande relatif. (2)

Les appareillages sont équipés d'un panneau de commandes, différencié du type de réglages référés aux typologies de l'appareil (TEMPERATURE POSITIVE, TEMPERATURE BASSE). (3)

Les compresseurs sont situés dans la partie supérieure des appareillages pour bénéficier d'une bonne aération et dissipation de chaleur. (4)

Les appareillages sont dotés d'une bassine, dotée d'un dispositif d'évaporation automatique de la buée, logée au dos externe de l'appareil. (5)

Aucun réfrigérateur n'est doté d'un bac pour recueillir l'eau de condensation.

Les appareillages sont équipés de deux différents systèmes d'illumination en fonction du modèle. Les lampes internes sont protégées pour éviter le contact avec les aliments ou bien les heurts qui pourraient les casser. (8)

Les portes des appareillages sont fournies de serrure à clé pour garantir une fermeture sûre. (9)

Les parties en contact avec le produit sont réalisées en acier inox ou revêtues de matière plastique atoxique. (10)

Le groupe frigorifique contient du fluide réfrigérant HFC admis par la législation actuelle.

ACCESSOIRES

Voire figure 7.

PLAQUETTE D'IDENTIFICATION

Pour toute communication avec le constructeur veuillez toujours citer le MODELE et le NUMÉRO D'IMMATRICULATION de la machine reportée sur la plaque des caractéristiques techniques. (11)

Contenu des champs de la plaquette de l'appareil (12)

- | | |
|---|--|
| 1) MODÈLE | F) COURANT FUSIBLE |
| 2) ENTREPRISE DE FABRICATION ET ADRESSE | G) TYPE GAS RÉFRIGÉRANT |
| 3) SIGLE MARQUAGE CE | H) QUANTITÉ GAS RÉFRIGÉRANT |
| 4) ANNÉE DE FABRICATION | L) CLASSE DE TEMPÉRATURE INSTALLATION FRIGORIFIQUE |
| 5) N° DE MATRICULE | M) PRESSION MAXIMUM DE L'EAU |
| 6) CLASSE D'ISOLEMENT ÉLECTRIQUE | N) TEMPERATURE DE L'EAU |
| 7) CLASSE DE PROTECTION ÉLECTRIQUE | O) CONSOMMATION DE L'EAU |
| A) TENSION D'ALIMENTATION ÉLECTRIQUE | P) PRESSION MINIMUM DE L'EAU |
| B) INTENSITÉ DU COURANT ÉLECTRIQUE | R) SYMBOLE DEEE |
| C) FRÉQUENCE D'ALIMENTATION ÉLECTRIQUE | W) PUISSANCE ÉLÉMENTS RÉCHAUFFANTS |
| D) PUISSANCE NOMINALE | |
| E) PUISSANCE TOTALE LAMPES | |

NOTES GENERALES A LA REMISE

A la remise, vérifiez que l'emballage soit intact et ne soit pas endommagé par le transport. (13)

Après avoir déballé la l'appareillage, assurez-vous d'avoir reçu toutes les parties, et que les caractéristiques et l'état correspondent aux spécifications de la commande.

Si ce n'est pas le cas, mettez-vous immédiatement en contact avec votre revendeur. (14)

Nous nous complimentons avec vous pour votre excellent choix et nous vous souhaitons de pouvoir utiliser au mieux vos appareillages en suivant les instructions et les précautions nécessaires contenus dans ce manuel. (15)

Nous vous rappelons que toute reproduction du présent manuel est interdite et que grâce à une recherche continue d'innovations et de qualité technologique les caractéristiques ici reportées pourraient changer sans préavis.

PRESCRIPTIONS DE SECURITE

ATTENTION: avant n'importe quelle opération d'entretien ou nettoyage il faut isoler l'appareil du courant:

Porter l'interrupteur présent sur le tableau de bord en position OFF (16a)

Portez l'interrupteur général en position OFF. (16b)

Enlevez la fiche (17)

ATTENTION: n'utilisez pas des fiches ou des prises dépourvues de mise à terre. (18)

La prise de courant doit être pourvue de MISE A TERRE. (19)

ATTENTION: n'utilisez pas d'adaptateurs ou de rallonges pour la jonction au réseau. (20)

ATTENTION: attendez un temps nécessaire à la réalisation de la température établie avant d'introduire les aliments à conserver. (21)

Couvrez toujours les aliments avec les pellicules spéciales, avant de les mettre dans les appareillages. (22)

ATTENTION: N'introduisez pas de boissons ou d'aliments chauds. (23)

ATTENTION: Placer les produits à conserver de façon à ne pas déborder des clayettes pour ne pas empêcher la circulation de l'air. Ne pas obstruer le secteur d'aspiration des ventilateurs. (24)

ATTENTION: ne faites pas de ménage autour de l'appareillage quand la porte est ouverte. (25)

Ne pas laver l'appareillage avec des jets d'eau directs et à une pression élevée. (26)

ATTENTION: n'utilisez pas de substances à base de chlore (eau de javel, acide muriatique, ecc.) ou de toute manière toxiques pour le nettoyage ou dans les parages des réfrigérateurs. (27)

ATTENTION: n'obstruez pas la partie supérieure du réfrigérateur ou les prises d'air, quand l'appareil est en marche ou sous tension. (28)

ATTENTION: ne pas poser des objets sur le fond du réfrigérateur, mais bien les disposer sur les clayettes prévues à cet effet. (29)

Le poids distribué sur toutes les clayettes doit être au maximum de 48 Kg.

Le nettoyage et l'entretien de l'installation réfrigérante et de la région des compresseurs nécessite de l'intervention d'un technicien spécialisé et autorisé, pour cette raison elle ne peut être effectuée par du personnel non qualifié. (30)

Pour des interventions d'entretien ou en cas d'anomalies débranchez complètement l'appareil; demandez l'intervention du SERVICE APRES-VENTE à un centre autorisé et l'emploi de pièces de rechange originales. (31)

La faute de ci-dessus peut compromettre l'état de sécurité des appareillages.

PRESCRIPTIONS HACCP

ATTENTION: Les aliments facilement périssables doivent être enlevés du milieu réfrigéré le plus tard possible de façon à être exposé à la température de la pièce le temps nécessaire.

ATTENTION: Ne jamais recongeler les aliments préalablement décongelés.

ATTENTION: Numérotez les outils et contrôlez deux fois par jour la température relevée en enregistrant les valeurs sur la fiche spéciale à garder pendant 24 mois.

ATTENTION: D'éventuelles interruptions d'électricité peuvent être effectuées en contrôlant le temps d'arrêt à travers une horloge électrique afin d'éliminer les aliments qui pourraient se détériorés.

Température maximale admises pour les aliments

Aliment	Température normale de stockage (°C)	Température maximale de transport (°C)
Lait frais pasteurisé	0÷+4	9
Crème fraîche	0÷+4	9
Yoghurt, ricotta et fromages frais	0÷+2	9
Produit de la pêche sous glace	0÷+2	0÷+4

CARACTERISTIQUES TECHNIQUES

Dans les dernières page du manuel: caracteristiques techniques. (32)

MISE EN OEUVRE ET INSTALLATION

Les appareillages sont toujours expédiées emballées et sur palette. (33)

A la réception et après avoir déballé, en cas de dommages comportez-vous comme décrit au chapitre "NOTES GERERALES A LA REMISE".

Les opérations de mise en oeuvre et d'installation doivent être effectuées par du personnel spécialisé. (30)

Enlevez le boîte d'emballage faisant attention à ne pas endommager les surfaces de l'appareil. (34)

ATTENTION: les éléments d'emballage (sachets en plastique, polystyrène expansé, clous etc.) ne doivent pas être laissés à la portée des enfants car ils peuvent devenir des sources de danger.

A l'aide d'un chariot à fourches soulevez le réfrigérateur et portez-le à sa place d'installation, faisant attention qu'il ne soit pas déséquilibré. (35)

ATTENTION: Ne transportez jamais le réfrigérateur en position horizontale; cette opération pourrait endommager la structure du l'installation de l'appareil. (36)

ATTENTION: soint pour la mise en position que pour les déplacements futurs ne poussez pas ni ne tirez l'appareillage pour éviter de la renverser ou d'endommager quelque partie. (37)

ATTENTION: ne placez pas l'appareillage en proximité de sources de chaleur ou en endroits avec température élevée; ceci causerait un plus bas rendement et un majeur usurage. (38)

ATTENTION : Tenir une distance d'au moins 50 cm du plafond. Il est possible de flanquer les appareils mais en cas de formation de condensation les éloigner d'au moins 2 cm.

Enlever la pellicule de protection du produit.

Cette opération peut provoquer des décharges électriques déplaisantes, même si elles ne sont pas dangereuses (électricité statique). On peut réduire ou éliminer l'inconvénient en maintenant une main toujours en contact avec l'appareil ou en raccordant à la terre la carcasse extérieure. (39)

Après avoir mis en place la machine, enlevez la palette en utilisant un burin et un marteau, faisant attention à ne pas abimer les pieds sous les blocs équarris ou l'appareillage. (40)

Tirez le bloc de renforcement en bois des fentes sur la partie inférieure. (41)

Le tuyau d'écoulement siphon présent sous l'appareil doit être branché directement au réseau d'égout avec écoulement ouvert. (41a)

Le tuyau d'alimentation (embout 3/4") de l'eau présent dans la partie supérieure de l'appareil doit être branché au réseau hydrique moyennant une vanne de sectionnement, un filtre à cartouche et clapet de non retour. (41b)

La température de l'eau d'alimentation doit être comprise entre 5°C et 40°C.

La pression de l'eau doit être suffisante à garantir un bon fonctionnement de l'appareil (>1bar).

Si l'eau employée est particulièrement riche d'impuretés, il est recommandable d'utiliser des filtres ou des épurateurs capables de la traiter.

A ce point il est possible de régler les pieds. (42)

Niveler l'appareil en le tenant légèrement incliné en arrière pour permettre la fermeture automatique optimale de la/des porte/s. (43)

Nettoyez avec de l'eau tiède et savon neutre (comme décrit au chapitre "NETTOYAGE") et montez les accessoires situés à l'intérieur de l'appareillage.

Le réfrigérateur est muni d'une fiche électrique type SHUKO. Vérifier que celle-ci soit conforme aux normes EN60320 et aux normes nationales. Remplacer la fiche avec une autre conforme aux normes, au cas où elle n'y correspondrait pas. (44)

ATTENTION: cette opération doit être exécutée par un technicien spécialisé. (30)

Vérifiez que la tension de réseau corresponde à celle indiquée sur la plaquette des caractéristiques techniques du réfrigérateur. (45)

Branchez finalement la fiche dans la prise de courant. (46)

A ce point les opérations de mise en oeuvre sont terminées.

L'appareillage doit être en outre inséré dans un système équipotentiel dont l'efficacité doit être vérifiée sur la base des normes en vigueur. Le raccord s'effectue moyennant une vis marquée par le sigle "Equipotentiel" située dans l'aire des compresseurs. (47)

TABLEAUX DE COMMANDE

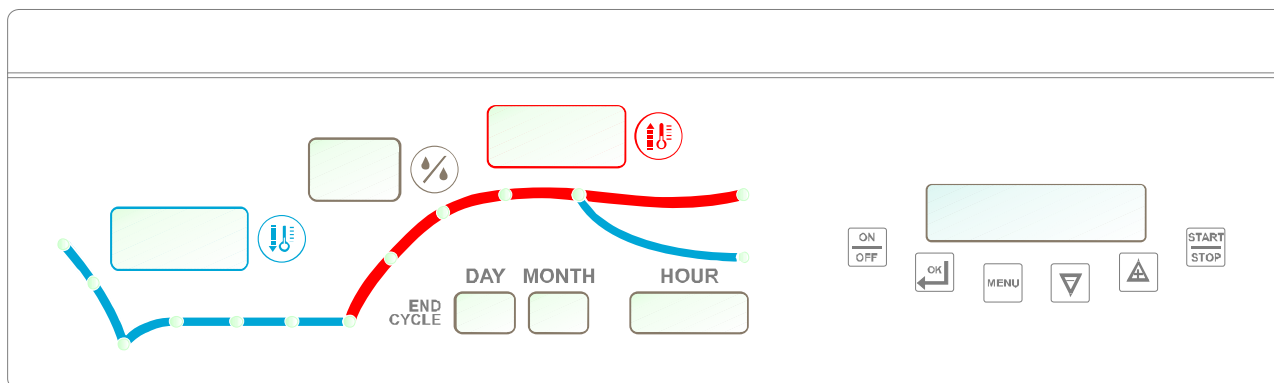

	<p><u>Touche ON/OFF</u> En appuyant sur la touche pendant 3 secondes le contrôleur s'éteint et le display affiche l'écriture OFF _ avec le curseur clignotant. En appuyant ensuite sur la touche, le contrôleur se rallume et s'affiche</p> <div style="border: 1px solid black; padding: 2px; width: fit-content; margin: 5px auto;"> 02/01/2009 Mar 17:35 </div>
	<p><u>Touche Enter</u> Permet d'accéder à un menu ou de sélectionner un paramètre. <i>Pendant un cycle, la pression de la touche permet d'afficher la date et l'heure.</i></p>
	<p><u>Touche Menu</u> Permet d'accéder au menu principal ou de retourner au menu précédent..</p>
	<p><u>Touche Up e Down</u> Permettent le défilement des divers menus ou la variation des valeurs des paramètres.</p>
	<p><u>Touche Start/Stop</u> Permet d'activer/bloquer un cycle. <i>Avec appareil au repos, en appuyant sur la touche pendant 3 secondes, le programme relatif au jour de la semaine où s'effectue l'activation part automatiquement.</i></p>
	<p>Visualise la température dans la cellule pendant la phase de réfrigération ou blocage fermentation.</p>
	<p>Visualise le pourcentage d'humidité dans la cellule. <i>Est allumé pendant les phases où le contrôle de l'humidité est prévu.</i></p>
	<p>Visualise la température dans la cellule pendant la phase de réchauffement, climatisation, ralentissement ou réveil.</p>
	<p>Indiquent la date et l'heure. <i>Affichent le jour, le mois et l'heure réelle avec carte en standby ou cycle manuel en cours.</i> <i>Affichent le jour, le mois et l'heure de fin de cycle si le cycle automatique est en cours.</i></p>

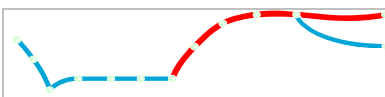

Visualise l'état d'avancement pendant le cycle manuel.
Les led relatives aux phases déjà conclues restent allumées pendant l'exécution des phases suivantes.

La carte prévoit la possibilité de régler des cycles **automatiques** ou d'exécuter un cycle **manuel**.

Cycle manuel: réglage des 3 phases:
REFRIGERATION, RECHAUFFEMENT ET CLIMATISATION

Cycles automatiques: (7 cycles réglés et/ou modifiables) constitués par les phases suivantes:
BLOCAGE DE LA FERMENTATION, CONSERVATION, REVEIL, FERMENTATION ET RALENTISSEMENT

MISE EN MARCHÉ

Pour le démarrage de l'appareil, procéder comme suit:

- Branchez la fiche dans sa prise ; (50)
- Mettre sous tension l'appareil en positionnant en ON ; (51)

- appuyer sur la touche



Le display visualise

02/01/2009
Mar 17:35

CHARGEMENT DU PRODUIT

A ce moment et pas avant vous pouvez mettre dans les appareillages les aliments à conserver.

- Distribuer uniformément le produit dans la cellule de façon à permettre une bonne circulation d'air.
- Eviter d'obturer les zones d'aérations à l'intérieure du frigo. Dans la cellule sont collés des adhésifs qui indiquent la limite de charge des clayettes.
- Ne laisser la porte ouverte que le temps nécessaire pour prendre ou déposer les aliments.
- Il est conseillé de tenir les clés hors de portée des enfants.





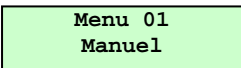
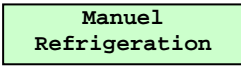

FONCTIONNEMENT

CYCLE MANUEL

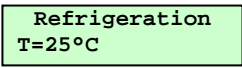











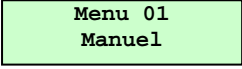

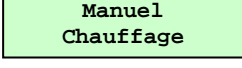
Le cycle manuel est constitué par 3 phases indépendantes et le passage d'une phase à l'autre n'est pas automatique.

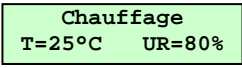
PHASE DE REFRIGERATION



	Appuyer sur la touche <u>menù</u> pour sélectionner le menu désiré
	Utiliser les touches <u>up</u> et <u>down</u> pour afficher 
	Appuyer sur la touche <u>enter</u> pour confirmer le choix
	Utiliser les touches <u>up</u> et <u>down</u> pour afficher 



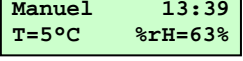





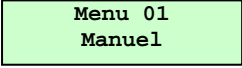



	Appuyer sur la touche <u>enter</u> pour confirmer le choix. On affiche 
	Appuyer sur la touche <u>enter</u> pour entrer dans la modalité de modification des SetPoint. <i>La valeur du SetPoint Température clignote, utiliser les touches  et  pour modifier la valeur</i>
	Appuyer sur la touche <u>enter</u> pour confirmer la nouvelle valeur
	Appuyer sur la touche <u>start/stop</u> pour activer immédiatement la phase sélectionnée. On affiche 

PHASE DE RECHAUFFEMENT

	Appuyer sur la touche <u>menù</u> pour sélectionner le menu désiré
	Utiliser les touches <u>up</u> et <u>down</u> pour afficher 
	Appuyer sur la touche <u>enter</u> pour confirmer le choix
	Utiliser les touches <u>up</u> et <u>down</u> pour afficher 
	Appuyer sur la touche <u>enter</u> pour confirmer le choix. On affiche 
	Appuyer sur la touche <u>enter</u> pour entrer dans la modalité de modification des SetPoint. <i>La valeur du SetPoint Température clignote, utiliser les touches  et  pour modifier la valeur</i>
	Appuyer sur la touche <u>enter</u> pour confirmer la nouvelle valeur. <i>La valeur du SetPoint d'Humidité clignote, utiliser les touches  et  pour modifier la valeur</i>
	Appuyer sur la touche <u>enter</u> pour confirmer la nouvelle valeur
	Appuyer sur la touche <u>start/stop</u> pour activer immédiatement la phase sélectionnée. On affiche 

PHASE DE CLIMATISATION

	Appuyer sur la touche <u>menù</u> pour sélectionner le menu désiré
	Utiliser les touches <u>up</u> et <u>down</u> pour afficher 

	Appuyer sur la touche <u>enter</u> pour confirmer le choix
 	Utiliser les touches <u>up</u> et <u>down</u> pour afficher Manuel Fermentation
	Appuyer sur la touche <u>enter</u> pour confirmer le choix. On affiche Fermentation T=25°C UR=80%
	Appuyer sur la touche <u>enter</u> pour entrer dans la modalité de modification des SetPoint. La valeur du SetPoint Température clignote, utiliser les touches  et  pour modifier la valeur
	Appuyer sur la touche <u>enter</u> pour confirmer la nouvelle valeur. La valeur du SetPoint d'Humidité clignote, utiliser les touches  et  pour modifier la valeur
	Appuyer sur la touche <u>enter</u> pour confirmer la nouvelle valeur
	Appuyer sur la touche <u>start/stop</u> pour activer immédiatement la phase sélectionnée. On affiche Manuel 13:39 T=5°C %rH=63%

CYCLE AUTOMATIQUE

La carte électronique a mémorisé 7 cycles comme suit:

APPAREILS -5°C / +30°C

CYCLE		P1	P2	P3	P4	P5	P6	P7
		Lundi	Mardi	Mercredi	Jeudi	Vendredi	Samedi	Dimanche
BLOPAGE	Durée	02:00	02:00	02:00	02:00	02:00	02:00	02:00
	Température	-5°C	-5°C	-5°C	-5°C	-5°C	-5°C	-5°C
CONSERVATION	Température	-1°C	-1°C	-1°C	-1°C	-1°C	-1°C	-1°C
REVEIL	Durée	02:00	02:00	02:00	02:00	02:00	02:00	02:00
	Température	20°C	20°C	20°C	20°C	20°C	20°C	20°C
	Humidité	70%	70%	70%	70%	70%	70%	70%
LEVAGE	Durée	02:00	02:00	02:00	02:00	02:00	02:00	02:00
	Température	28°C	28°C	28°C	28°C	28°C	28°C	28°C
	Humidité	80%	80%	80%	80%	80%	80%	80%
FIN PROGRAMME	Heure	01:00	01:00	01:00	01:00	01:00	01:00	01:00
BLOPAGE	Température	6°C	6°C	6°C	6°C	6°C	6°C	6°C
	Humidité	80%	80%	80%	80%	80%	80%	80%

APPAREILS -18°C / +30°C







CYCLE		P1	P2	P3	P4	P5	P6	P7
		Lundi	Mardi	Mercredi	Jeudi	Vendredi	Samedi	Dimanche
BLOPAGE	Durée	02:00	02:00	02:00	02:00	02:00	02:00	02:00
	Température	-20°C	-20°C	-20°C	-20°C	-20°C	-20°C	-20°C
CONSERVATION	Température	-1°C	-1°C	-1°C	-1°C	-1°C	-1°C	-1°C
REVEIL	Durée	02:00	02:00	02:00	02:00	02:00	02:00	02:00
	Température	20°C	20°C	20°C	20°C	20°C	20°C	20°C
	Humidité	70%	70%	70%	70%	70%	70%	70%
LEVAGE	Durée	02:00	02:00	02:00	02:00	02:00	02:00	02:00
	Température	28°C	28°C	28°C	28°C	28°C	28°C	28°C
	Humidité	80%	80%	80%	80%	80%	80%	80%
FIN PROGRAMME	Heure	01:00	01:00	01:00	01:00	01:00	01:00	01:00
BLOPAGE	Température	6°C	6°C	6°C	6°C	6°C	6°C	6°C
	Humidité	80%	80%	80%	80%	80%	80%	80%

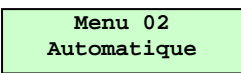

APPAREILS -2°C / +30°C

CYCLE		P1	P2	P3	P4	P5	P6	P7
		Lundi	Mardi	Mercredi	Jeudi	Vendredi	Samedi	Dimanche
BLOPAGE	Durée	02:00	02:00	02:00	02:00	02:00	02:00	02:00
	Température	-2°C	-2°C	-2°C	-2°C	-2°C	-2°C	-2°C
CONSERVATION	Température	+2°C	+2°C	+2°C	+2°C	+2°C	+2°C	+2°C
REVEIL	Durée	02:00	02:00	02:00	02:00	02:00	02:00	02:00
	Température	20°C	20°C	20°C	20°C	20°C	20°C	20°C
	Humidité	70%	70%	70%	70%	70%	70%	70%
LEVAGE	Durée	02:00	02:00	02:00	02:00	02:00	02:00	02:00
	Température	28°C	28°C	28°C	28°C	28°C	28°C	28°C
	Humidité	80%	80%	80%	80%	80%	80%	80%
FIN PROGRAMME	Heure	01:00	01:00	01:00	01:00	01:00	01:00	01:00
BLOPAGE	Température	6°C	6°C	6°C	6°C	6°C	6°C	6°C
	Humidité	80%	80%	80%	80%	80%	80%	80%

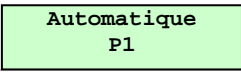
*Veuillez noter: température maximale de la pâte 27°C – farine vxx 320 – augmenter de 0,01 la levure – augmenter de 0,01 le sel pour les produits salés ou le sucre pour les produits sucrés.

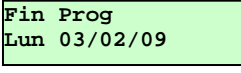



Chaque cycle automatique est constitué par 5 cinq phases.
Le cycle commence toujours à partir du BLOPAGE DE LA FERMENTATION et le passage aux phases successives advient automatiquement d'après la durée de chaque phase et d'après le jour et l'heure de fin du cycle réglés.







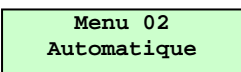

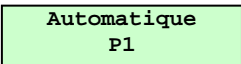









	Appuyer sur la touche <u>menù</u> pour sélectionner le menu désiré
	Utiliser les touches <u>up</u> et <u>down</u> pour afficher 
	Appuyer sur la touche <u>enter</u> pour entrer dans la sélection des programmes déjà mémorisés (P01... P07). On affiche 
	Utiliser les touches <u>up</u> et <u>down</u> pour choisir le programme souhaité
	Appuyer sur la touche <u>enter</u> . On affiche 

Si la date de fin indiquée est celle souhaitée, appuyer sur la touche  , pour confirmer et mettre en marche l'exécution du cycle, sinon appuyer sur la touche  pour modifier la date de fin de cycle.

MODIFICATION CYCLE AUTOMATIQUE

Pour modification les cycles pré-réglés suivre les instructions suivantes.



	Appuyer sur la touche <u>menù</u> pour sélectionner le menu désiré
	Utiliser les touches <u>up</u> et <u>down</u> pour afficher 
	Appuyer sur la touche Enter pour entrer dans la sélection des programmes déjà mémorisés (P01... P07). On affiche 



 	Utiliser les touches <u>up</u> et <u>down</u> pour choisir le programme souhaité
	Appuyer sur la touche <u>enter</u> pour entrer dans la modalité de réglage du programme sélectionné
	Avec la touche <u>down</u> on peut passer d'une phase à l'autre et le display affiche la phase du cycle avec les valeurs courantes des setpoint
	Appuyer sur la touche <u>enter</u> pour entrer dans modification. La valeur des <i>Heures</i> se met à clignoter. Utiliser les touches  et  pour modifier la valeur.
	Appuyer sur la touche <u>enter</u> pour confirmer la nouvelle valeur, l'élément ne clignote plus. La valeur des <i>Minutes</i> se met à clignoter. Utiliser les touches  et  pour modifier la valeur.
	Appuyer sur la touche <u>enter</u> pour confirmer la nouvelle valeur, l'élément ne clignote plus. La valeur du <i>SetPoint de Température</i> se met à clignoter. Utiliser les touches  et  pour modifier la valeur.
	Appuyer sur la touche <u>enter</u> pour confirmer la nouvelle valeur, l'élément ne clignote plus. La valeur du <i>SetPoint d'Humidité</i> se met à clignoter (si présent). Utiliser les touches  et  pour modifier la valeur.
	Appuyer sur la touche <u>enter</u> pour confirmer la nouvelle valeur, l'élément ne clignote plus. Utiliser les touches  et  pour sélectionner les autres phases et modifier leurs Setpoint.

La pression de la touche  permet la mémorisation du programme et le retour au menu précédent.

La pression de la touche  permet au contraire de mettre en marche l'exécution du programme, le display affiche la date de fin de cycle

Fin Prog
Lun 03/04/06

Si la date de fin indiquée est celle souhaitée, appuyer sur la touche , pour confirmer et mettre en marche l'exécution du cycle, sinon appuyer sur la touche  pour modifier la date de fin de cycle.

Le jour clignote, avec la touche  changer la date de fin de programme, appuyer sur la touche  pour confirmer la nouvelle date et appuyer sur la touche  pour mettre en marche l'exécution du cycle.

EXÉCUTION D'UN CYCLE AUTOMATIQUE

Pendant l'exécution d'un cycle automatique le display affiche:

P2 Blocage
T=19°C

En indiquant le numéro du programme en cours, la phase en cours, la température actuelle dans la cellule et si cette phase prévoit également une humidification avec sonde, le pourcentage d'humidité présent s'affiche.

Affichage date et heure des phases

Appuyer sur la touche  pour afficher la date et l'heure de fin de la phase en cours.

Appuyer sur la touche  pour afficher la date et l'heure de fin des phases successives.

On affiche

Fin PH0 09:00
Lun 03/04/09

Là où PH0 indique que la phase 0 du programme est en cours, précisément la phase de Blocage.

Les autres phases sont indiquées par:
 PH1 qui indique Conservation
 PH2 qui indique Réveil
 PH3 qui indique Levage
 PH4 qui indique Ralentissement

La pression de la touche , ou bien un délai de 5 secondes, ramènent à l'affichage précédent.

Affichage état INPUT/OUTPUT

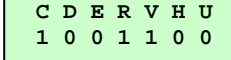
Appuyer sur la touche  pour afficher l'état des INPUT/OUTPUT. 

La pression de la touche , ou bien un délai de 20 secondes, ramènent à l'affichage précédent.

Affichage date et heure









Appuyer sur la touche  pour afficher la date et l'heure. 

La pression de la touche , ou bien un délai de 5 secondes, ramènent à l'affichage précédent.

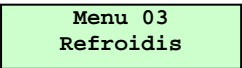
A tout moment la pression de la touche  bloque l'exécution du cycle. Le cycle reste quand même sélectionné.

CYCLE DE REFROIDISSEMENT

Il est conseillé de mettre en route un cycle de refroidissement avant de sélectionner n'importe quel cycle.

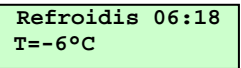
	Appuyer sur la touche <u>menu</u> pour sélectionner le menu désiré
 	Utiliser les touches <u>up</u> et <u>down</u> pour afficher 
	Appuyer sur la touche <u>enter</u> pour entrer dans la modalité de modification des SetPoint. La valeur du SetPoint Température clignote, utiliser les touches  et  pour modifier la valeur
	Appuyer sur la touche <u>enter</u> pour confirmer la nouvelle valeur
	Appuyer sur la touche start/stop pour démarrer immédiatement le cycle de refroidissement On affiche 

En appuyant sur la touche  on peut revenir à la modification du SetPoint.



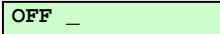

ARRET

Pour arrêter l'appareillage dans n'importe quelle condition il suffira d'appuyer sur la touche  ;
 s'affiche sur le display 

ATTENTION: La touche  N'isole PAS l'appareil de la tension électrique.

Pour isoler l'appareil de la tension électrique débrancher la prise. (17)

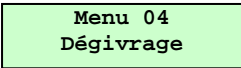

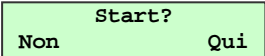





DEGIVRAGE

	Appuyer sur la touche <u>menù</u> pour sélectionner le menu désiré
 	Utiliser les touches <u>up</u> et <u>down</u> pour afficher 
	Appuyer sur la touche <u>enter</u> pour accéder à la demande Start de dégivrage On affiche 

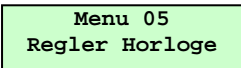

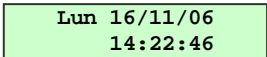



Appuyer sur la touche  pour sortir du menu et le dégivrage n'est pas activé.

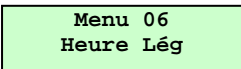

Appuyer sur la touche  pour activer un dégivrage.

REGLAGE HORLOGE

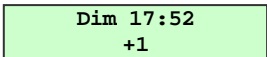







	Appuyer sur la touche <u>menù</u> pour sélectionner le menu désiré
 	Utiliser les touches <u>up</u> et <u>down</u> pour afficher 
	Appuyer sur la touche <u>enter</u> pour entrer dans la modalité de réglage de l'heure. On affiche  Utiliser les touches  et  pour modifier le chiffre qui clignote
	Appuyer sur la touche <u>enter</u> pour confirmer la valeur et passer à la donnée suivante
	Appuyer sur la touche <u>menù</u> pour sortir de la sélection

REGLAGE HEURE LEGALE

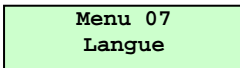
	Appuyer sur la touche <u>menù</u> pour sélectionner le menu désiré
 	Utiliser les touches <u>up</u> et <u>down</u> pour afficher 
	Appuyer sur la touche <u>enter</u> pour entrer dans la modalité de réglage de l'heure légale. On affiche  Utiliser les touches  et  pour modifier l'heure

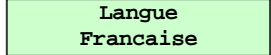
	Appuyer sur la touche <u>enter</u> pour confirmer la nouvelle valeur
	Appuyer sur la touche <u>menù</u> pour sortir de la sélection







LANGUE





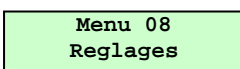

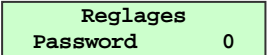

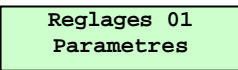
	Appuyer sur la touche <u>menù</u> pour sélectionner le menu désiré
	Utiliser les touches <u>up</u> et <u>down</u> pour afficher 
	Appuyer sur la touche <u>enter</u> pour afficher la langue utilisée actuellement. On affiche 
	Utiliser les touches <u>up</u> et <u>down</u> pour visualiser la langue désirée
	Appuyer sur la touche <u>enter</u> pour confirmer le choix
	Appuyer sur la touche <u>menù</u> pour sortir de la sélection

PROGRAMMATION

PARAMETRES

Modification des paramètres

	Appuyer sur la touche <u>menù</u> pour sélectionner le menu désiré
	Utiliser les touches <u>up</u> et <u>down</u> pour afficher 
	Appuyer sur la touche <u>enter</u> pour confirmer le choix. On affiche 
	Utiliser les touches <u>up</u> et <u>down</u> pour sélectionner le mot de passe “-19”
	Appuyer sur la touche <u>enter</u> pour confirmer le choix. Le premier sous-menu s’affiche 

	Appuyer sur la touche <u>enter</u> pour entrer dans la modalité de programmation des paramètres Le premier paramètre est affiché P01=-5°C
 	Utiliser les touches <u>up</u> et <u>down</u> pour tous les paramètres du contrôleur
	Appuyer sur la touche <u>enter</u> pour confirmer le choix
 	Utiliser les touches <u>up</u> et <u>down</u> pour sélectionner la nouvelle valeur du paramètre
	Appuyer sur la touche <u>enter</u> pour confirmer le choix
	Appuyer sur la touche <u>menù</u> pour retourner au menu principal

DESCRIPTION PARAMETRES

Nr.	Description	Default -2/+30°C	Default -5/+30°C	Default -18/+30°C	Min	Max	Unité
Configurations Générales							
P1	Choix affichage sous tension 0 = aucun 1 = EVCO s.r.l.	1	1	1	0	1	---
P2	0 = Celsius 1 = Fahrenheit	0	0	0	0	1	---
P3	Offset sonde cellule	0	-2	-2	-15	15	°C/°F
P4	Offset sonde évaporateur	0	0	0	-15	15	°C/°F
P5	Limite inférieure sonde humidité	0	0	0	0	P6	%
P6	Limite supérieure sonde humidité	100	100	100	P5	200	%
P7	Polarité entrée pour contact porte 0 = NO 1 = NC	0	0	0	0	1	---
P8	Polarité entrée BT pour thermostat 0 = NO 1 = NC	0	0	0	0	1	---
P9	Durée Hors tension pour rétablissement programme automatique	15	15	15	1	60	minutes
P10	Choix comportement après Hors tension pour programme automatique : 0 = un cycle automatique repart seulement si le Hors tension est inférieur à P9 minutes 1 = un cycle automatique repart toujours	1	1	1	1	1	---
P11	Durée Hors tension pour rétablissement programme manuel	15	15	15	1	60	minutes
P12	Choix comportement après Hors tension pour programme manuel: 0 = un cycle manuel repart seulement si le Hors tension est inférieur à P11 minutes 1 = un cycle manuel repart toujours	1	1	1	0	1	---
Setpoint							
P13	Min set point de refroidissement réglable	-2	-5	-24	-30	P14	°C/°F
P14	Max set point refroidissement réglable	10	10	5	P13	90	°C/°F
P15	Hystérésis de refroidissement	2	2	2	1	10	°C/°F
P16	Zone morte froid pour réfrigération, blocage et conservation	0	0	0	0	10	°C/°F
P17	Zone morte froid pour réchauffement, réveil et levage	0	0	0	0	10	°C/°F
P18	Zone morte froid pour climatisation et ralentissement	0	0	0	0	10	°C/°F
P19	Min set point de réchauffement réglable	5	5	5	0	P20	°C/°F
P20	Max set point de réchauffement réglable	30	30	30	P19	90	°C/°F
P21	Hystérésis de réchauffement	1	1	1	1	10	°C/°F
P22	Zone morte chaud pour réchauffement, réveil et levage	1	1	1	0	10	°C/°F
P23	Zone morte chaud pour climatisation et ralentissement	1	1	1	0	10	°C/°F
P24	Nombre de pas régulation résistances en réveil	9	9	9	1	10	---







Nr.	Description	Default -2/+30°C	Default -5/+30°C	Default -18/+30°C	Min	Max	Unité
P25	Nombre de pas régulation résistances en fermentation	1	1	1	1	10	---
Délais Compresseur							
P26	Retard entre deux ON successifs du compresseur	3	3	3	0	60	minutes
P27	Retard entre un OFF et un ON successif du compresseur	2	2	2	0	60	minutes
P28	Retard allumage compresseur à partir du power ON	1	1	1	0	255	minutes
P29	Durée allumage forcé compresseur au début des phases de réveil, levage et ralentissement	0	0	0	0	60	minutes
Délais Résistances							
P30	Durée minimum activation résistances	0	0	0	0	255	secondes
Humidification et Déshumidification							
P31	Limite inférieure température cellule pour humidification / déshumidification	5	5	5	0	90	°C/°F
P32	Modalité gestion humidité 0 = avec sonde humidité 1 = à des cycles de temps d'après le pourcentage réglé 2 = à pas d'une minute	0	0	0	0	2	---
P33	Temps de pause si P32 = 2	10	10	10	0	60	minutes
P34	Durée cycle d'humidification si p32 = 1	60	60	60	30	600	secondes
P35	Temps max humidification si p32 = 1	30	30	30	0	P34	secondes
P36	Active l'humidification durant les phases de blocage du levage et de la conservation 0 = désactivée 1 = activée	0	0	0	0	1	---
P37	Hystérésis pour humidification	1	1	1	1	100	%
P38	Zone morte pour humidification	4	4	4	0	100	%
P39	Bande de Régulation Proportionnelle pour Humidification	4	4	4	0	20	%
P40	Durée de cycle pour Régulation Proportionnelle Humidification	1	1	1	1	255	secondes /minutes
P41	Base durées pour Durée de Cycle 0 = secondes 1 = minutes	1	1	1	0	1	---
P42	Hystérésis pour déshumidification	1	1	1	1	100	%
P43	Zone morte pour déshumidification	5	5	5	0	100	%
P44	Durée Tentative Déshumidification avec Electrovalve	1	1	1	1	255	secondes
Ventilation							
P45	Activation Régulation Proportionnelle Ventilateurs Évaporateur 0 = régulation ON/OFF 1 = régulation proportionnelle	0	0	0	0	1	---
P46	Fonctionnement ventilateurs pour blocage fermentation 0 = fonctionnement en parallèle 1 = fonctionnement continu	1	1	1	0	1	---
P47	Fonctionnement ventilateurs évaporateur pour conservation 0 = fonctionnement en parallèle 1 = fonctionnement continu	1	1	1	0	1	---
P48	Fonctionnement ventilateurs évaporateur pour réveil 0 = fonctionnement en parallèle 1 = fonctionnement continu	0	0	0	0	1	---
P49	Fonctionnement ventilateurs évaporateur pour fermentation 0 = fonctionnement en parallèle 1 = fonctionnement continu	0	0	0	0	1	---
P50	Fonctionnement ventilateurs évaporateur pour ralentissement 0 = fonctionnement en parallèle 1 = fonctionnement continu	0	0	0	0	1	---
P51	Fonctionnement ventilateurs évaporateur pour réfrigération 0 = fonctionnement en parallèle 1 = fonctionnement	1	1	1	0	1	---
P52	Fonctionnement ventilateurs évaporateur pour réchauffement 0 = fonctionnement en parallèle 1 = fonctionnement continu	0	0	0	0	1	---
P53	Fonctionnement ventilateurs pour climatisation 0 = fonctionnement en parallèle 1 = fonctionnement continu	0	0	0	0	1	---
P54	Retard désactivation ventilateurs évaporateur en fonctionnement en parallèle	1	1	1	0	255	minutes
P55	Temps de travail ventilateurs évaporateur si fonctionnement en parallèle	1	1	1	0	255	minutes
P56	Temps de pause ventilateurs évaporateur si fonctionnement en parallèle	1	1	1	0	255	minutes
P57	Vitesse Minimum Ventilateurs Évaporateur	0	0	0	0	P58	%
P58	Vitesse Maximum Ventilateurs Évaporateur	100	100	100	P57	100	%
P59	Vitesse Minimum Ventilateurs Évaporateur durées déshumidification	20	20	20	P57	P58	%



Nr.	Description	Default -2/+30°C	Default -5/+30°C	Default -18/+30°C	Min	Max	Unité
Dégivrage							
P60	Température Évaporateur pour fin dégivrage	8	8	8	-40	99	°C
P61	Intervalle entre deux dégivrages successifs 0 = le dégivrage ne se répète pas	8	8	6	0	10	heures
P62	Durée maximale cycle de dégivrage	10	10	30	1	120	minutes
P63	Temps d'égouttement	2	2	3	0	30	minutes
P64	Etat des ventilateurs pendant le dégivrage	0	0	0	0	1	---
P65	Durée blocage ventilateurs après égouttement	2	2	2	0	15	minutes
Refroidissement							
P66	Minimum Setpoint pour Refroidissement	-2	-5	-5	-30	P67	°C
P67	Maximum Setpoint pour Refroidissement	10	10	10	P66	30	°C
P68	Preset Refroidissement	-2	-5	-5	P66	P67	°C
Réglage et Modification Programmes							
P69	Activation Réglage Programmes	1	1	1	0	1	---
P70	Activation Modification Programmes	1	1	1	0	1	---
P71	Gestion K3: 0=ElectroValve; 1= Lumière; 2 = Déshumidification	1	1	1	0	2	---
P72	Gestion Compresseur avec Porte Ouverte: 0 = aucun effet; 1= éteint compresseur	0	0	0	0	1	---
P73	Type dégivrage: 0 = Resistance; 1 = Gaz Chaud	0	0	0	0	1	---
P74	Alarme haute température Évaporateur	55	55	55	0	70	°C
P75	Active alarme haute température Évaporateur: 0= non activé; 1= activé	1	1	1	0	1	---
P76	Activation de la Déshumidification 0= désactivée 1= activée en Réveil, Levage, Ralentissement, Climatisation, Réchauffement 2=active aussi en in Blocage et Conservation	0	0	0	0	2	---
P77	Durée Resistance ON	3	3	3	1	255	secondes minutes
P78	Durée Resistance OFF (0= résistances toujours allumées)	1	1	1	0	255	secondes minutes

A noter











- Contrôler les délais de protection du compresseur dans la mesure où les défauts sont réglés sur zéro.
- Les paramètres P5 et P6 sont utilisés pour définir le range de la sonde humidité. Le paramètre P5 doit être placé égal au pourcentage d'humidité correspondant à 4mA et le paramètre P6 doit être placé égal au pourcentage d'humidité correspondant à 20mA.
- Après une modification au parameter P32 vérifier le set point d'humidité des programmes automatiques et manuels.

ENTREES/SORTIES

	Appuyer sur la touche <i>menu</i> pour sélectionner le menu désiré
	Utiliser les touches <i>up</i> et <i>down</i> pour afficher Menu 08 Reglages
	Appuyer sur la touche <i>enter</i> pour confirmer le choix. On affiche Reglages Password 0
	Utiliser les touches <i>up</i> et <i>down</i> pour sélectionner le mot de passe “-19”
	Appuyer sur la touche <i>enter</i> pour confirmer le choix. Le premier sous-menu s'affiche Reglages 01 Parametres
	Utiliser les touches <i>up</i> et <i>down</i> pour afficher Reglages 02 Entrees/Sorties
	Appuyer sur la touche Enter pour entrer dans la modalité de visualisation des entrées et sorties. On affiche Cell -6°C Evapor -15°C

 	<p>Utiliser les touches up et down pour défiler les grandeurs à visualiser</p> <table border="1" data-bbox="416 241 660 293"> <tr><td>Cell</td><td>-6°C</td></tr> <tr><td>Evapor</td><td>15°C</td></tr> </table> <p>Valeur des températures de la cellule et de l'évaporateur</p> <table border="1" data-bbox="416 304 660 356"> <tr><td>Humidité</td><td>14%</td></tr> </table> <p>Valeur sonde Humidité</p> <table border="1" data-bbox="416 367 660 418"> <tr><td>C</td><td>D</td><td>E</td><td>R</td><td>V</td><td>H</td><td>U</td></tr> <tr><td>1</td><td>0</td><td>0</td><td>1</td><td>1</td><td>0</td><td>0</td></tr> </table> <p>Etat des sorties 1 = relais activé 0 = relais</p> <table border="1" data-bbox="416 450 660 501"> <tr><td>DI1</td><td>DI2</td><td>FAN</td></tr> <tr><td>0</td><td>1</td><td>98</td></tr> </table> <p>Etat des sorties digitales et vitesse du ventilateur évaporateur</p> <table border="1" data-bbox="1031 315 1439 394"> <tr><td>C</td><td>Compresseur</td><td>V</td><td>Ventilateurs</td></tr> <tr><td>D</td><td>Dégivrage</td><td>H</td><td>Gén vapeur</td></tr> <tr><td>EV</td><td>Lumière Déshum</td><td>U</td><td>Humidificateur</td></tr> <tr><td>R</td><td>Resistances</td><td></td><td></td></tr> </table>	Cell	-6°C	Evapor	15°C	Humidité	14%	C	D	E	R	V	H	U	1	0	0	1	1	0	0	DI1	DI2	FAN	0	1	98	C	Compresseur	V	Ventilateurs	D	Dégivrage	H	Gén vapeur	EV	Lumière Déshum	U	Humidificateur	R	Resistances		
Cell	-6°C																																										
Evapor	15°C																																										
Humidité	14%																																										
C	D	E	R	V	H	U																																					
1	0	0	1	1	0	0																																					
DI1	DI2	FAN																																									
0	1	98																																									
C	Compresseur	V	Ventilateurs																																								
D	Dégivrage	H	Gén vapeur																																								
EV	Lumière Déshum	U	Humidificateur																																								
R	Resistances																																										
	<p>Appuyer sur la touche <u>menù</u> pour retourner au menu principal</p>																																										

RESTAURATION PARAMÈTRES DE DEFAULT



	<p>Appuyer sur la touche <u>menù</u> pour sélectionner le menu désiré</p>		
 	<p>Utiliser les touches <u>up</u> et <u>down</u> pour afficher</p> <table border="1" data-bbox="962 857 1203 920"> <tr><td>Menu 08</td></tr> <tr><td>Reglages</td></tr> </table>	Menu 08	Reglages
Menu 08			
Reglages			
	<p>Appuyer sur la touche <u>enter</u> pour confirmer le choix.</p> <p>On affiche</p> <table border="1" data-bbox="683 1003 948 1059"> <tr><td>Reglages</td></tr> <tr><td>Password 0</td></tr> </table>	Reglages	Password 0
Reglages			
Password 0			
 	<p>Utiliser les touches <u>up</u> et <u>down</u> pour sélectionner le mot de passe “-19”</p>		
	<p>Appuyer sur la touche <u>enter</u> pour confirmer le choix.</p> <p>Le premier sous-menu s'affiche</p> <table border="1" data-bbox="903 1238 1144 1301"> <tr><td>Reglages 01</td></tr> <tr><td>Parametres</td></tr> </table>	Reglages 01	Parametres
Reglages 01			
Parametres			
 	<p>Utiliser les touches <u>up</u> et <u>down</u> pour afficher</p> <table border="1" data-bbox="975 1332 1216 1395"> <tr><td>Reglages 03</td></tr> <tr><td>Rétablissement</td></tr> </table>	Reglages 03	Rétablissement
Reglages 03			
Rétablissement			
	<p>Appuyer sur la touche Enter pour accéder à la demande d'effacement des données enregistrées en mémoire. On affiche</p> <table border="1" data-bbox="903 1464 1144 1527"> <tr><td>Rétablissement?</td></tr> <tr><td>Non Qui</td></tr> </table>	Rétablissement?	Non Qui
Rétablissement?			
Non Qui			











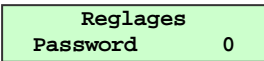



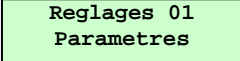

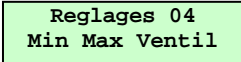
Appuyer sur la touche  pour sortir du menu et n'effectuer aucun rétablissement.

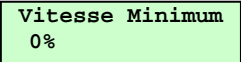
Appuyer sur la touche  pour rétablir les paramètres d'origine de défaut.

Appuyer sur la touche  pour retourner au menu principal.

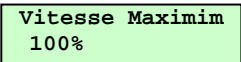
REGULATION DE LA VITESSE DES VENTILATEURS

	<p>Appuyer sur la touche <u>menù</u> pour sélectionner le menu désiré</p>		
 	<p>Utiliser les touches <u>up</u> et <u>down</u> pour afficher</p> <table border="1" data-bbox="962 1946 1203 2009"> <tr><td>Menu 08</td></tr> <tr><td>Reglages</td></tr> </table>	Menu 08	Reglages
Menu 08			
Reglages			

	Appuyer sur la touche <u>enter</u> pour confirmer le choix. On affiche 
 	Utiliser les touches <u>up</u> et <u>down</u> pour sélectionner le mot de passe “-19”
	Appuyer sur la touche <u>enter</u> pour confirmer le choix. Le premier sous-menu s’affiche 
 	Utiliser les touches <u>up</u> et <u>down</u> pour afficher 
	Appuyer sur la touche <u>enter</u> pour entrer dans la modalité de regulation de la vitesse des ventilateurs. On affiche 
	Appuyer sur la touche <u>enter</u> pour entrer dans modification. La valeur se met à clignoter. Utiliser les touches  et  pour modifier la valeur.
	Appuyer sur la touche <u>enter</u> pour confirmer la nouvelle valeur. On affiche  Utiliser les touches  et  pour modifier la valeur.
	Appuyer sur la touche <u>enter</u> pour confirmer la nouvelle valeur.
	Appuyer sur la touche <u>menu</u> pour retourner au menu principal

ALARMS

Des signalisations visuelles et sonores sont présentes en cas de dysfonctionnements.

Sonde Cellule

Une panne de la sonde provoque une Alarme de la Sonde Cellule, le buzzer sonne et le message d’erreur clignote sur le display:

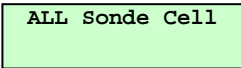

Tout cycle en cours est bloqué et toutes les sorties désactivées.
Le buzzer peut être éteint en appuyant sur n’importe quelle touche.
Lorsque l’erreur disparaît le cycle reprend.

Thermostat de sécurité

Quand l’alarme du Thermostat est relevée par la carte, le buzzer sonne et l’alarme s’affiche sur le display:

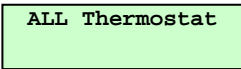

Tout cycle en cours est bloqué et toutes les sorties désactivées.
Le buzzer peut être éteint en appuyant sur n’importe quelle touche.

Lorsque l’erreur disparaît appuyer sur la touche  pour réarmer la carte.

Sonde évaporateur

Une panne de la sonde provoque une Alarme panne de la Sonde Évaporateur, le buzzer sonne et le message d'erreur clignote sur le display:

ALL Sonde Évap

Tout cycle en cours est bloqué et toutes les sorties désactivées.
Le buzzer peut être éteint en appuyant sur n'importe quelle touche.
Lorsque l'erreur disparaît le cycle reprend.

Haute température Évaporateur

Quand la Sonde Évaporateur atteint la valeur établie dans le paramètre P74, l'alarme de haute température de l'Évaporateur s'active. Le buzzer sonne et le message d'erreur clignote sur le display:

ALL Haute T Evap

Tout cycle en cours est bloqué et toutes les sorties désactivées.
Le buzzer peut être éteint en appuyant sur n'importe quelle touche.

Lorsque l'erreur disparaît appuyer sur la touche  pour réarmer la carte.

Sonde Humidité

Une panne de la sonde provoque une Alarme panne de la Sonde Humidité, le buzzer sonne et le message d'erreur clignote sur le display:

ALL SondeHumid

Tout cycle en cours est bloqué et toutes les sorties désactivées.
Le buzzer peut être éteint en appuyant sur n'importe quelle touche.
Lorsque l'erreur disparaît le cycle reprend.

MicroPorte

Chaque ouverture de la porte est signalée par le message Porte Ouverte qui clignote:

Porte Ouverte

L'ouverture de la porte pendant un cycle de neutralisation, arrête les Ventilateurs, les Résistances et l'Humidificateur; le Compresseur et le Générateur de Vapeur restent allumés.
Le buzzer sonne, mais on peut l'arrêter en appuyant sur n'importe quelle touche et la signalisation rentre automatiquement à la fermeture de la porte.
A chaque ouverture de la Porte la Lumière s'allume.

Dysfonctionnement RTC

Si un dysfonctionnement du RTC se produit, une alarme de RTC est signalée; le buzzer sonne et le message d'alarme clignote sur le display:

ALL RTC

Tout cycle en cours est bloqué et toutes les sorties désactivées.
Le buzzer peut être éteint en appuyant sur n'importe quelle touche.
On peut aller dans le Menu réglage Horloge et configurer les valeurs courantes du RTC; après la carte se remet en standby.

Alarme EEPROM

Si des incohérences sont relevées dans les données mémorisées en Eeprom, une alarme de Eeprom est signalée; le buzzer sonne et le message d'erreur clignote sur le display:

ALL EEprom

Tout cycle en cours est bloqué et toutes les sorties désactivées.
Le buzzer peut être éteint en appuyant sur n'importe quelle touche.

Pour réarmer la carte appuyer sur la touche . Après le réarmement la carte se remet en standby.
NB: après une alarme Eeprom tous les paramètres sont rétablis à la valeur de défaut.

IRREGULARITES DE FONCTIONNEMENT

En cas de fonctionnement irrégulier, avant d'appeler le service après-vente des environs, vérifiez que:

l'interrupteur général 1 est allumé et le courant est présent, (63)
la valeur de la température établie est celle désirée; (65)
les portes sont parfaitement fermées;
l'appareil n'est pas placé au voisinage de sources de chaleur; (38)
le condensateur est propre et le ventilateur fonctionne régulièrement;
qu'il n'y ait un givre excessif sur la batterie en évaporation.

Si ces contrôles résultent négatifs, s'adresser au service d'assistance le plus proche, en fournissant les indications sur le modèle, le numéro de série et d'immatriculation estampillés sur la plaquette des caractéristiques, posée sur le tableau de bord de l'appareil. (11)

NETTOYAGE JOURNALIER

Pour garantir une parfaite hygiène et une parfaite conservation de l'appareillage (66) il est conseillé d'effectuer ordinairement et/ou quotidiennement les opérations de nettoyage suivantes :

Nettoyer soigneusement les surfaces externes de l'appareil en passant une éponge douce trempée dans de l'eau avec du détergent neutre, essorée, et ceci uniquement dans le sens du satinage.

Le détergent ne doit pas contenir de chlore et ne doit pas être abrasif. (67)

Les détergents conseillés sont ceux de type:

Détergent désinfectant à action combinée;

(contenant des tensioactifs non ioniques, benzalconique chlorure, substances chélatantes et pH tampon)

Détergent pour laboratoire, neutre, pour lavage Manuel;

(contenant des tensioactifs anioniques et non ioniques)

Dégraissant pour milieux alimentaires;

(contenant des tensioactifs anioniques et EDTA)

Avant l'utilisation diluer éventuellement les détergents suivant les instructions reportées sur l'étiquette.

Laisser agir les détergents pendant au moins 5 minutes.

Rincer soigneusement les parois du réfrigérateur avec une éponge passée plusieurs fois sous l'eau courante.(69).

Essuyer soigneusement avec une éponge propre.

ATTENTION: n'utilisez absolument pas d'outils ou objets qui peuvent produire des écorchures et par conséquent la formation de rouille. (68)

Eliminer la présence éventuelle de taches ou de résidus alimentaires à l'intérieur de l'appareil (voir paragraphe suivant)

TACHES DE NOURRITURE ET RESTES RACORNIS

En cas de présence dans le réfrigérateur de taches ou de résidus alimentaires, laver avec de l'eau et enlever celles-ci avant qu'elles puissent s'incruster.

Si les résidus se sont déjà incrustés, procéder de la façon suivante :

Utiliser une éponge douce mouillée avec de l'eau tiède et du détergent neutre (vous pouvez utiliser ceux prévus pour le nettoyage quotidien, à plus haute concentration parmi celles prévues sur les étiquettes). (72)

Humidifier le résidu incrusté de façon à le maintenir humide pendant au moins 30 minutes en passant toutes les 5 minutes l'éponge mouillée avec l'eau et le détergent sur la partie durcie.

A la fin du trempage, enlever le résidu avec l'éponge toujours mouillée avec l'eau et le détergent neutre.

Si nécessaire, recourir à une spatule en bois ou à une paille fine en acier inox, en faisant attention à ne pas endommager la surface du réfrigérateur. (70)

A la fin du processus il est conseillé un cycle de nettoyage quotidien de toutes les surfaces internes du réfrigérateur.

Une fois le nettoyage terminé, rincer soigneusement avec une éponge rincée sous l'eau courante. Essuyer soigneusement avec une éponge propre.

Le sol autour et sous les appareillages doit aussi être tenu propre et en parfaite hygiène.

Lavez avec eau et savon ou du détergent neutre. (71)

Protéger la carrosserie en y appliquant de la cire au silicone.

NETTOYAGE ET ENTRETIEN PERIODIQUE

Pour un rendement constant de l'appareil, il est opportun d'accomplir des opérations de nettoyage et d'entretien périodiques.

Avant de commencer les opérations, procédez comme ci-dessous:

tournez l'interrupteur du réseau en position OFF (16)

tirez la fiche de la prise et attendez le complet dégivrage de l'appareillage. (17)

A l'aide d'un aspirateur, d'un pinceau ou d'une brosse non métallique nettoyer soigneusement le condensateur du groupe réfrigérant ainsi que l'évaporateur après avoir enlevé toutes les protections. (73)

ATTENTION: Le nettoyage et l'entretien de l'installation réfrigérante et de la région des compresseurs nécessite de l'intervention d'un technicien spécialisé et autorisé, pour cette raison elle ne peut être effectuée par du personnel non qualifié. (30)

Nettoyer les surfaces externes et internes de l'appareil en suivant les indications reportées dans le paragraphe nettoyage journalier.

Les réfrigérateurs à température positive "TEMPERATURE NORMALE" sont pourvus d'écoulement dans la partie inférieure de l'appareillage.

Vérifiez que l'ouverture ne soit pas obstruée et éventuellement nettoyez-la. (75)

Après avoir ouvert le panneau de fermeture du kit générateur vapeur, démonter le tuyau vapeur et le décalcifier avec de l'eau courante. Désassembler le chauffe-eau du kit et le décalcifier avec de l'eau courante. Assembler à nouveau le tout. (76a)

A ce point les opérations de nettoyage et entretien général sont terminées.

INTERRUPTIONS D'USAGE

En cas de longues périodes d'inactivité de l'appareillage et pour la maintenir dans les meilleures conditions, agissez de la manière suivante:

Prenez l'interrupteur du courant en position OFF. (16)

enlevez la fiche de la prise. (17)

videz le réfrigérateur et nettoyez-le comme décrit au chapitre "NETTOYAGE". (76)

vider l'eau présente à l'intérieur du chauffe-eau après avoir enlevé la bague serre tuyau et extrait le tuyau. (76a)

laissez les portes des chambres entrouvertes pour éviter la formation de mauvaises odeurs. (77)

couvrez le groupe compresseur avec une toile en nylon pour le protéger de la poussière. (78)

CONSEILS UTILES POUR L'ENTRETIEN DE L'ACIER INOX

Les appareillages sont construites en ACIER INOX AISI 304. (79)

Pour le nettoyage et l'entretien des parties en acier inox, tenez-vous à ce qui est spécifié ci de suite, tenant compte que la première et fondamentale règle est de garantir la non toxicité et le maximum d'hygiène des produits traités.

L'acier inox a une fine pellicule d'oxide qui empêche la formation de rouille.

Il y a des substances ou détergents qui toutefois peuvent détruire ou manger cette couche et faire naître des corrosions.

Avant d'utiliser n'importe quel produit détergent informez-vous toujours chez votre fournisseur de confiance quel est le produit détergent neutre plus indiqué ne produisant pas de corrosions sur l'acier. (73)

En cas d'écorchures sur les surfaces il est nécessaire de les polir avec de la laine d'ACIER INOX très fine ou une éponge abrasive synthétique fibreuse en frottant dans le sens du satinage. (80)

ATTENTION: pour le nettoyage de l'ACIER INOX n'utilisez jamais des pailles de fer et ne les laissez pas posées dessus car des légers dépôts ferreux pourraient rester sur les surfaces et provoquer des formations de rouille par contamination et compromettre l'hygiène. (81)

PROBLEMES DE FONCTIONNEMENT

Considérez que bien souvent les problèmes de fonctionnement qui se vérifient sont causés banalement, ils peuvent être solutionnés la plupart du temps sans l'intervention d'un technicien spécialisé. Par conséquent, avant de contacter le service d'assistance technique, faire les contrôles suivants :

PROBLEME	CAUSES POSSIBLES
L'appareil ne s'allume pas	Contrôler que la fiche soit introduite correctement dans la prise de courant
	Contrôler qu'il n'y ait pas de coupure de courant
La température intérieure est trop élevée	Vérifier le réglage du thermostat
	Vérifier que l'appareil ne subisse pas l'influence d'une source de chaleur
	Vérifier que la porte se ferme correctement
L'appareil est trop bruyant	Vérifier la mise à niveau de l'appareil. Une position non horizontale peut être à l'origine de vibrations
	Vérifier que le contact de l'appareil avec quelque objet ou autre appareil ne provoque pas de vibrations
A l'intérieure du frigo il y a des odeurs désagréables	Il ya des odeurs particulièrement fortes (par exemple le fromage et le melon), dans des emballages non fermés hermétiquement
	Les surfaces intérieures doivent être propres
Sur l'appareil se forme de la vapeur d'eau condensée	L'humidité est très élevée
	Les portes ne se sont pas bien fermées

Si en dépit de ces contrôles le problème persiste, s'adresser au service d'assistance technique et signaler : la nature du problème

le modèle et le numéro d'immatriculation de l'appareil qui peuvent être relevés sur la plaque des caractéristiques électriques, posée sous le tableau de bord de l'appareil.

DÉMOLITION ET ÉLIMINATION DES DÉCHETS

STOCKAGE DES DÉCHETS

A la fin du cycle de vie du produit, éviter de jeter l'appareil dans l'environnement. Les portes devront être démontées avant la destruction de l'appareil.

Les déchets spéciaux peuvent être stockés provisoirement avant de les soumettre à un traitement et/ou stockage définitifs. Dans tous les cas, il est impératif d'observer les lois en vigueur pour la protection de l'environnement du pays de destination de l'appareil.

PROCÉDURE INHÉRENTE AUX OPÉRATIONS DE DÉMONTAGE DE L'APPAREIL

Étant donné qu'il existe à ce propos une législation différente dans chaque pays, il est impératif d'observer les contraintes imposées par les lois et les organismes relatifs du pays où aura lieu la destruction.

En règle générale, il faut consigner l'appareillage à un centre spécialisé pour le collectage de la ferraille/démolition. Démontez l'appareillage en regroupant les composants en fonction de leur nature chimique. Se rappeler que le compresseur contient de l'huile lubrifiante et du fluide frigorigène qui peuvent être récupérés et réutilisés et que les composants de l'appareillage sont des déchets spéciaux (pouvant toutefois être éliminés comme les ordures ménagères).

Rendre l'appareil inutilisable en retirant le câble d'alimentation et tout dispositif de verrouillage des compartiments pour que personne ne puisse s'y enfermer par mégarde.

DANS TOUS LES CAS, LE DÉMONTAGE DOIT ÊTRE EFFECTUÉ PAR UN PERSONNEL QUALIFIÉ.

SÉCURITÉ POUR L'ÉLIMINATION DES DÉCHETS D'ÉQUIPEMENTS ÉLECTRIQUES ET ÉLECTRONIQUES (DIRECTIVE DEEE 2002/96/CE)

Ne pas évacuer les matières polluantes dans l'atmosphère. Effectuer l'élimination dans le respect des lois en vigueur en la matière.

En référence à la Directive DEEE 2002/96/CE (déchets d'équipements électriques et électroniques), l'utilisateur, lorsqu'il veut éliminer les appareils, doit les transporter vers des points de collecte agréés, ou les remettre encore installés au vendeur lors d'un nouvel achat.

Tous les appareils qui doivent être éliminés conformément à la Directive DEEE 2002/96/CE, sont marqués d'un symbole spécial (12).

L'évacuation abusive des déchets d'équipements électriques et électroniques est passible de sanctions conformément aux lois en vigueur dans le territoire où l'infraction a été commise.

LES DÉCHETS DES ÉQUIPEMENTS ÉLECTRIQUES ET ÉLECTRONIQUES PEUVENT CONTENIR DES SUBSTANCES DANGEREUSES AVEC DES EFFETS POTENTIELLEMENT NOCIFS SUR L'ENVIRONNEMENT ET SUR LA SANTÉ DES PERSONNES. L'ÉVACUATION ET L'ÉLIMINATION DOIVENT ÊTRE FAITES DE FAÇON CORRECTE.

INVERSION PORTE(82)

Les appareillages à une porte sont livrés avec sens d'ouverture de porte vers la droite.

Lors de la transformation avec la charnière à gauche, procéder comme suit :

Faire tourner le tableau de bord sur les entêtes latérales en enlevant la vis bloquée "F".

Dévisser les deux vis de fixation de la bride "A" et la vis d'arrêt de la charnière "B".

Enlever la porte, démonter la charnière "B" et la pièce "E", en invertissant leur montage.

Démontez la bride inférieure "D" et la monter de nouveau sur le côté opposé, dans le logement prévu à cet effet.

Positionner la porte en introduisant le perçage de la pièce inférieure "E" sur le pivot de la bride "D".

Fixer la bride A" à la structure sur le côté opposé, en vissant à fond les vis de fixation.

Avant de serrer les vis des brides, vérifier la cote de la charnière qui doit être d'environ 12 mm. et que la porte soit perpendiculaire à la structure.

Déplacer le micro présent sur le tableau de bord de la partie opposée, en utilisant les trous prédisposés.

Monter de nouveau le tableau de bord.

NOTE: Les opérations de démontage des brides et leur successif montage doivent être effectuées avec la porte fermée.

FICHE TECHNIQUE DU REFRIGERANT

R404a: composants du fluide

Trifluoréthane (HFC 143a)	52%
Pentafluoréthane (HFC 125)	44%
Tétrafluoréthane (HFC 134a)	4%
GWP = 3750	
ODP = 0	

Identification des dangers

L'inhalation prolongée peut provoquer des effets anesthésiques. Des expositions particulièrement prolongées aux inhalations peuvent provoquer des anomalies du rythme cardiaque et mort subite. Le produit nébulisé ou sous forme de jets peut provoquer des brûlures de gel aux yeux et à la peau.

Premiers secours

• Inhalation :

Eloigner le blessé du lieu de l'exposition, le couvrir pour le réchauffer et le garder au repos. Si nécessaire, lui donner de l'oxygène. Pratiquer la respiration artificielle si la respiration s'est arrêtée ou risque de s'arrêter ; en cas d'arrêt cardiaque, pratiquer un massage cardiaque externe. Appeler tout de suite l'assistance médicale.

• Contact avec la peau :

Dégeler avec de l'eau les parties blessées. Enlever les vêtements contaminés.

ATTENTION : les vêtements peuvent adhérer à la peau suite à brûlures de gel.

En cas de contact avec la peau, laver immédiatement et abondamment avec de l'eau tiède. Si des symptômes se manifestent (irritations ou formation d'ampoules), appeler l'assistance médicale.

• Contact avec les yeux :

Laver immédiatement avec une solution pour lavage oculaire ou de l'eau propre, en tenant les paupières bien ouvertes, pendant au moins 10 minutes. Appeler l'assistance médicale.

• Ingestion :

Peut provoquer des vomissements. Si le blessé est conscient, lui faire rincer la bouche avec de l'eau et lui faire boire 200-300 ml d'eau. Appeler tout de suite l'assistance médicale.

• Ultérieurs soins médicaux :

Traitement symptomatique et thérapie de support si nécessaire. Ne pas donner d'adrénaline et des médecines sympathomimétiques similaires suite à exposition, à cause du danger d'arythmie cardiaque et possible arrêt cardiaque.

Informations écologiques

Persistance et dégradation

• HFC 143a :

Se décompose lentement dans l'atmosphère inférieure (troposphère). Sa durée dans l'atmosphère est de 55 ans.

• HFC 125 :

Se décompose lentement dans l'atmosphère inférieure (troposphère). Sa durée dans l'atmosphère est de 40 ans.

• HFC 134a :

Se décompose avec relative rapidité dans l'atmosphère inférieure (troposphère). Sa durée dans l'atmosphère est de 15,6 ans.

• HFC 143a, 125, 134a :

N'influencent pas le smog photochimique (c'est à dire n'appartient pas aux composants organiques volatiles - VOC - conformément à ce convenu par l'accord UNECE). Ne provoque pas la raréfaction de l'ozone.

Les décharges de produit dans l'atmosphère ne provoquent pas la contamination des eaux à long terme.

LE ESHEMA ELECTRIQUE EST INDIQUE SUR LA DERNIERE PAGE DU LIVRET DES INSTRUCTIONS

POS	DESCRIPTION	POS	DESCRIPTION
1	GROUPE COMPRESSEUR	44	RELAIS COMPRESSEUR
2	VENTILATEUR COMPRESSEUR	44A	RELAIS PTC
3	PLAQUE A BORNES GENERALE	44B	RELAIS MICRO MAGNETIQUE
6	INTERRUPTEUR DE DEGIVRAGE	56	FILTRE
8	FICHE	69	BORNE MISE A LA TERRE
9	VENTILATEUR EVAPORATEUR	70	PRESSOSTAT SECUR. HAUTE PRESSION
9A	VENTILATEUR EVAPORATEUR	75	ELECTROSOUPAPE
9B	VENTILATEUR EVAPORATEUR	76	MICRO MAGNETIQUE
10	LAMPE ILLUMINATION INTERNE	85	BOITE CONNEXION
10A	LAMPE ILLUMINATION INTERNE	86	SONDE CONDENSATEUR
12	ELECTROSOUPAPE	90	THERMORÉGULATEUR DIGITAL
14	VARIATEUR D'HUMIDITE AVEC TEMOIN	91	RESISTANCE PTC
15	MICRO INTERRUPTEUR VENTILATEUR	96	CARTE ELECTRONIQUE
15A	MICRO INTERRUPTEUR VENTILATEUR	101	RESISTANCE TAMPON
18	TEMOIN THERMOSTAT DE SECURITE	102	THERMOSTAT BIMETALLIQUE DE SECURITE
19	THERMOSTAT DE SECURITE	103	SONDE D'HUMIDITE
20	RESISTANCE ANTICONDENSATION PORTE	104	REGULATEUR DE NIVEAU
20A	RESISTANCE ANTICONDENSATION PORTE	105	SONDE DE NIVEAU
21	RESISTANCE DE DEGIVRAGE	106	THERMOSTAT DE SECURITE GENERATEUR DE VAPEUR
22	RESISTANCE FOND BASSINES	107	RESISTANCE ELECTRIQUE CHAMBRE
25	TRANSFORMATEUR	108	RESISTANCE GENERATEUR DE VAPEUR
28	INTERRUPTEUR ILLUMINATION INTERNE	109	CARTE TABLEAU APPAREILLAGE DE FERMENTATION
29	INDUCTANCE LAMPES TL	110	CARTE DE COMMANDES APPAREILLAGE DE FERMENTATION
30	STARTER	111	CARTE EXPANSION RELAIS APPAREILLAGE DE FERMENTATION
31	LAMPE TL	112	ELECTROVANNE EAU D'HUMIDIFICATION

INHALT

BESCHREIBUNG	2
ZUBHÖR	2
IDENTIFIKATIONS ETIKETTE	2
ALLGEMEINE MERKMALE BEI DER ABLIEFERUNG	3
SICHERHEITS VORSCHRIFTEN	3
HACCP VORSCHRIFTEN	4
TECHNISCHE EIGENSCHAFTEN	4
EINRICHTUNG	4
SCHALTTAFELN	6
INGANGSETZEN	7
BESCHICKUNG DES PRODUKTES	7
BETRIEB MANUELLER ZYKLUS – AUTOMATISCHER ZYKLUS	7
ANHALTEN	13
ENTFROSTUNG	13
EINSTELLEN DER UHR	13
EINSTELLEN DER SOMMERZEIT	14
SPRACHE	14
PROGRAMMIERUNG	15
ALARME	20
BETRIEB SONOMALIEN	21
TGLICHE REINIGUNG	21
SPEISEFLECKEN UND GEHRTETEN RESTE	22
REINIGUNG UND PERIODISCHE WARTUNG	22
BETRIEB UNTERBRECHUNGEN	23
WERTVOLLE RTE FR DIE PFLEGE DES ROSTFREIER STAHL	23
BETRIEBSSTÖRUNGEN	23
ENTSORGUNG	24
TÜR INVERSION	24
TECHNISCHES DATENBLATT FÜR KÜHLMITTEL	25

BESCHREIBUNG

Diese Apparatur wurde zur Kühlung, Erwärmung und Konservierung der Nahrungsmittel entworfen. Jeder andere Gebrauch ist als unsachgemäß anzusehen.

ACHTUNG: DIE Maschinen sind nicht für die Installation im Freien und/oder in Umgebungen geeignet, die atmosphärischen Einflüssen ausgesetzt sind.

Der Hersteller lehnt jegliche Verantwortung für unsachgemäße Anwendungen der Produkte ab.

Diese Apparaturen sind mit Stahltür verfügbar.

Die Apparaturen sind mit „NORMALTEMPERATUR“ und „NIEDERTEMPERATUR“ Kühlanlagen angefertigt um die Nahrungsmittelkonservierung zu verschiedenen Temperaturen zu befriedigen. (1)

Die Apparaturen sind mit einem gegen die Oxidation schützenden Flügelverdampfer, mit einem luftdichten Kompressor, mit einem Kupfer-Aluminium Kondensator, mit einem Feuchtigkeitsset, mit einem Innenwiderstand, mit einer Feuchtigkeitssonde und relativer Schalttafel ausgestattet. (2)

Die Apparaturen sind mit einer Steuerungstafel ausgestattet, die sich von dem auf die Gerättypologie beziehenden Einstellungstyp unterscheidet. (POSITIVTEMPERATUR, NIEDERTEMPERATUR). (3)

Die Kompressoren befinden sich im oberen Teil, um eine günstigere Lüftung und Kühlung zu haben. (4)

Die Apparaturen sind mit einem Behälter ausgestattet, der mit einer an der Geräterückseite angelegten automatischen Kondenswasser-Verdampfvorrichtung ausgestattet ist. (5)

Kein Kühlschrank ist mit Kondenztropfschale ausgestattet.

Die Apparaturen sind dem Modell gemäß mit zwei verschiedenen Beleuchtungssystemen ausgestattet. Die Innenlampen sind geschützt um den Kontakt mit den Nahrungsmitteln und eventuelle Stöße, die diese zerbrechen könnten, zu vermeiden. (8)

Die Türen sind für einen sicheren Verschluss mit Schlösser ausgestattet. (9)

Die Bereiche, die in Kontakt mit dem Produkt kommen, bestehen aus Stahl oder sind mit lebensmittelechtem Kunststoffmaterial überzogen. (10)

Bei den Kühlgruppen wird ein von den aktuellen Gesetzgebungen zugelassenes Kühlmittel vom Typ HFC verwendet.

ZUBHÖR

Siehe Bild Nummer 7.

IDENTIFIKATIONS ETIKETTE

Für jede Anfrage können Sie den Hersteller kontaktieren. Das MODELL und die MATRIKELNUMMER des Geräts, die auf dem elektrischen Daten Schild erscheinen (siehe das Schild unter dem Instrumentenbrett), müssen genau angegeben werden. (11)

Inhaltsfeld des technischen Gerätedatenschildes (12)

- | | |
|-----------------------------|-----------------------------|
| 1) MODELL | E) GESAMTLEISTUNG LAMPEN |
| 2) BAUFIRMA UND ADRESSE | F) ABSCHMELZSTROM |
| 3) MARKIERUNGSSIEGEL CE | G) KÜHLGASTYP |
| 4) BAUJAHR | H) KÜHLGASMENGE |
| 5) KENNUMMER | L) TEMPERATURAKLASSE ANLAGE |
| 6) ELEKTR. ISOLATIONSKLASSE | M) WASSERHÖCHSTDRUCK |
| 7) ELEKTR. SCHUTZKLASSE | N) WASSERTEMPERATUR |
| A) SPEISESPANNUNG | O) WASSERVERBRAUCH |
| B) STROMSTÄRKE | P) WASSERTIEFD RUCK |
| C) SPEISEFREQUENZ | R) WEEE-SYMBOL |
| D) NENNLEISTUNG | W) HEIZKÖRPERLEIST |

ALLGEMEINE MERKMALE BEI DER ABLIEFERUNG

Bei der Lieferung sich versichern dass die Verpackung unversehrt ist, und keine Schaden hat. (13)

Nader Kühltischschrank verpackt ist sich versichern dass alle Teile da sind, und dass die Eigenschaften und der Zustand der Bestellung einstimmen.

Anderenfalls sich sofort mit dem Verkäufer in Verbindung stellen. (14)

Wir gratulieren Ihnen für die sehr gute Wahl und hoffen die beste Benützung unserer Kühlschränke nach den enthaltenen Anweisungen und Vorschriften dieses Handbuches. (15)

Vorsicht: der Nachdruck dieses Handbuches ist verboten und die hier beschriebene Eigenschaften könnten ohne Voranzeige zwecks einer ständigen Erneuerung und technologischen Qualität geändert werden.

SICHERHEITS VORSCHRIFTEN

ACHTUNG: vorher jede Wartung oder Reinigung muss man zuerst die Maschine vom Strom isolieren:

Den auf dem Armaturenbrett vorhandenen Schalter auf OFF-Zustand stellen (16a)

Der Netzschalter auf OFF stellen. (16b)

Der stecker herausziehen (17)

ACHTUNG: kein Stecker oder Steckdose ohne Erdung gebrauchen. (18)

Die Steckdose muss mit ERDUNG gestattet sein. (19)

ACHTUNG: keine Adapter oder Verlängerungen für die Verbindung gebrauchen. (20)

ACHTUNG: eine gewisse Zeit warten, dass die eingestellte Temperatur erreicht wird, bevor man die Speisen zu konservieren einfügt. (21)

Die Speisen immer mit dem dazu bestimmten Film zudecken. (22)

ACHTUNG: keine warme Speisen oder Gedrinke einführen. (23)

ACHTUNG: Die Lebensmittel so lagern, daß sie nicht über die Roste hinausragen, um so den Luftstrom nicht zu behindern. Die Ventilatorsaugzone nicht verstopfen. (24)

ACHTUNG: nicht herum dem Schrank putzen, wenn die Türen geöffnet sind. (25)

Reinigen Sie das Gerät nie mit direktem Wasserstrahl oder hohem Druck. (26)

ACHTUNG: keine Stoffe mit der Grundlage von Chlor (Bleichmittel, Salzsäure, usw.) oder irgendwie giftig für die Reinigung oder in der Nähe vom Schrank gebrauchen. (27)

ACHTUNG: das obere Teil des Schrankes oder die Lufteinlässe nicht zudecken, wenn die Maschine in Betrieb oder unter Spannung ist. (28)

ACHTUNG: Stellen Sie keine Gegenstände auf dem Boden des Kühlschranks ab, sondern benutzen Sie die hierfür vorgesehenen Gitterroste (29).

Der Gitterrost darf mit einem gleichmäßig verteilten Gewicht von maximal 48kg beladen werden.

Die Reinigung und die Wartung der Kühlanlagen und des Kompressorenraumes verlangt der Eingriff von einem berechtigten Fachmann, dafür können sie nicht von unfähige Personen ausgeführt werden. (30)

Für Wartungen oder im Zufall von Anomalien die Maschine vollständig abschalten; der Eingriff eines berechtigten KUNDENDIENST und originale Ersatzteile fordern. (31)

Die Nichteinhaltung von wie oben beschrieben kann die Sicherheit der Kühlschränke gefährden.

HACCP VORSCHRIFTEN

ACHTUNG: Die leicht verderbliche Lebensmittel müssen so spät wie möglich vom Kühlschrank weggenommen werden, sodaß sie nur für die allernötigste Zeit der Raumtemperatur ausgestellt sind.

ACHTUNG: Die aufgetaute Lebensmittel dürfen nicht wieder tiefgekühlt werden.

ACHTUNG: Die Vorrichtungen müssen numeriert werden und die Temperaturbestimmung muß zweimal täglich kontrolliert werden. Die Werte müssen schriftlich registriert und für 24 Monate aufbewahrt werden.

ACHTUNG: Eine elektrische Uhr registriert wie lange die eventuelle Stromunterbrechung dauert, um die beschädigte Lebensmittel wegnehmen zu können.

Maximale zugelassene Warentemperaturen

Lebensmittel	Normale Lagerungs- temperatur (°C)	Maximale Transport- temperatur (°C)
Frische pasteurisierte Milch	0÷+4	9
Frische Sahne	0÷+4	9
Joghurt, quarkähnlicher Frischkäse und Frischkäse	0÷+2	9
gekühlte Fischprodukte	0÷+2	0÷+4

TECHNISCHE EIGENSCHAFTEN

In der letzten Seite des Handbuchs: technische Daten. (32)

EINRICHTUNG

Die Kühlschränke sind immer verpackt und auf Palette gesendet. (33)

Beim Empfang und nach der Auspackung im Falle von Schäden oder fehlenden Stücken sich verhalten wie im Kapitel "ALLGEMEINE MERKMALE BEI DER ABLIEFERUNG" beschrieben.

Die Einrichtungs- und Installationsarbeiten müssen von Fachpersonal durchgeführt werden. (30)

Die verpackte Schachtel behutsam entnehmen, um das Gerät nicht zu beschädigen. (34)

ACHTUNG: Die Verpackungsteile (Plastiktüten, Schaumpolyesterol, Nägel, u.s.w.) von Kindern fernhalten, da Sie eine potenzielle Gefahrenquelle darstellen.

Mit einem Gabelstapler den Kühlschrank aufheben und mit Vorsicht für das Gleichgewicht ihn auf seinen Platz stellen. (35)

ACHTUNG: den Kühlschrank nie in horizontaler Lage transportieren; dies könnte Schäden an der Struktur und Anlage verursachen. (36)

ACHTUNG: beim Platzstellen oder beim Rücken des Kühlschranks nicht schieben oder ziehen, um ihn nicht umzukippen oder beschädigen. (37)

ACHTUNG: den Kühlschrank nicht in der Nähe von Wärmequellen oder in warme Räume stellen; dies würde eine niedrigere Leistung mit größerer Abnutzung verursachen. (38)

ACHTUNG: Eine Mindestdistanz von 50 cm von der Decke halten. Die Geräte können nebeneinander gestellt werden, aber bei Kondenzwasserbildung diese wenigstens 2 cm voneinander entfernen.

Den Schutzfilm vom Produkt entfernen.

Dieser Vorgang kann leichte elektrische Schläge hervorrufen, die aber völlig ungefährlich sind. (statische Elektrizität).

Dies kann aber reduziert oder eliminiert werden, indem man mit einer Hand das Gerät berührt und den Außenmantel erdet. (39)

Nach dem Positionieren die Palette mit Meißel und Hammer beseitigen und aufpassen um die Füße hinter den Blöcken oder der Kühltür nicht zu beschädigen. (40)

Die Verstärkung unter dem Schrank von den Schienen herausziehen. (41)

Das unter dem Gerät vorhandene Siphon-Abflussrohr muss direkt an das Kanalnetz mit offenem Abfluss angeschlossen werden. (41a)

Das am Geräteoberteil vorhandene Wasserzuleitungsrohr (Anschluss 3/4") muss mittels eines Absperrventils, eines Einsatzfilters und eines Rückschlagventils an das Wassernetz angeschlossen werden. (41b)

Die Speisewassertemperatur muss zwischen 5°C und 40°C liegen.

Der Wasserdruck muss ausreichen, damit ein guter Betrieb des Gerätes gewährleistet wird. (>1bar).

Falls das verwendete Wasser besonders reich an Unreinheiten ist, ist es empfehlenswert geeignete Filter oder Kläranlagen zur Behandlung zu benutzen.

Jetzt können die Füße eingestellt werden. (42)

Das Gerät wird nach hinten geneigt und nivelliert um eine optimale Tür/Türen- Selbstschliessung zu erlauben. (43)

Mit lauwarmes Wasser und Seife (wie im Kapitel "REINIGUNG" beschrieben) putzen und die Zubehörteile die sich im Kühltür befinden montieren.

Der Kühltür ist mit einem Stecker des Typen SHUKO ausgestattet. Prüfen Sie bitte, ob derselbe den EN60320 E Normen und den nationalen Normen entspricht. Ansonsten den Stecker mit einem den Normen entsprechenden austauschen. (44)

ACHTUNG: dieser arbeitgang muß von einem fachmann durchgeführt werden. (30)

Sich versichern dass die Netzspannung und die auf der Etikette angegebene Spannung übereinstimmen. (45)

Der Stecker in die Steckdose einfügen. (46)

Die Einstellung ist jetzt zu Ende.

Außerdem muß das Gerät in einem equipotenzialen System eingeschlossen werden, dessen Effektivität nach den bestehenden Normen überprüft werden muß. Der Anschluß wird mittels einer durch das Siegel "Equipotenziale" gekennzeichneten Schraube, im Kompressorenbereich eingesetzt, vorgenommen. (47)

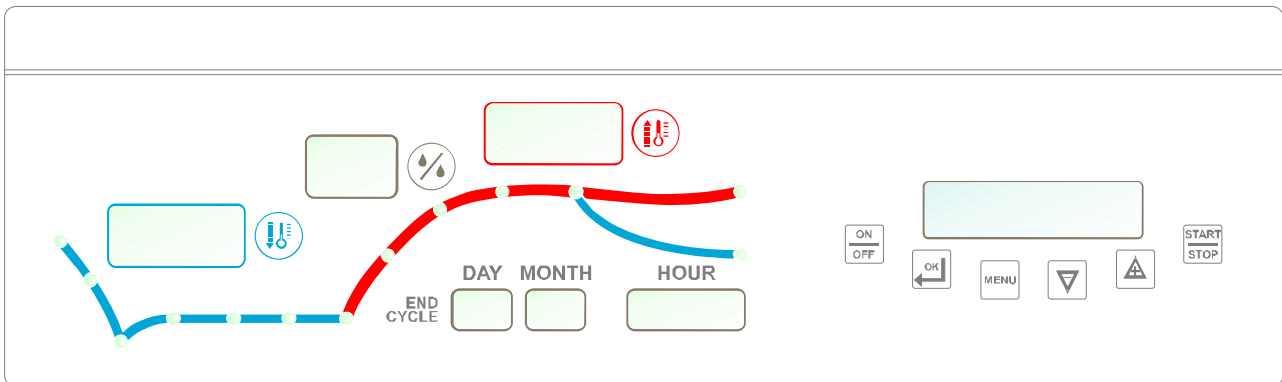

	<p><u>ON/OFF Taste</u> Falls die Taste 5 Sekunden lang gedrückt, verlöscht der Controller sich und auf dem Display wird die Schrift angezeigt </p> <p>Durch anschließendes Drücken der Taste schaltet sich der Controller wieder ein und wird angezeigt </p>
	<p><u>Enter Taste</u> Beim Drücken der Taste wird ein Menü aufgerufen oder ein Parameter gewählt.</p> <p><i>Während eines Zyklus können durch Drücken der Taste Datum und Uhrzeit angezeigt werden.</i></p>
	<p><u>Menu Taste</u> Beim Drücken der Taste wird das Hauptmenü aufgerufen oder Sie können ins vorherige Menü zurück.</p>
	<p><u>Up und Down Tasten</u> Verschiedene Menüs durchlaufen oder Parameterwerte können abgeändert werden.</p>
	<p><u>Start/Stop Taste</u> Gestattet, einen Zyklus zu starten/blockieren.</p> <p><i>Mit Apparat im Ruhezustand, durch Drücken der Taste für 3 Sek. startet automatisch das Programm, dass zu dem Wochentag gehört, an dem die Aktivierung stattfindet.</i></p>
	<p>Anzeige der Zelltemperatur während der Kühlphase, Konservierung und Gärverzögerung</p>
	<p>Anzeige des Feuchtigkeitsprozentsatzes in der Zelle. <i>Ist während der Phasen eingeschaltet, in denen die Kontrolle der Feuchtigkeit vorgesehen ist.</i></p>
	<p>Anzeige der Zelltemperatur während der Erwärmungsphase, Klimatisierung, Gärungsverzögerung oder – erwecken</p>
	<p>Zeigen Datum und Uhrzeit an. <i>Zeigen tatsächlichen Tag, Monat und Uhrzeit mit Karte im Standby-Modus oder wenn der manuelle Zyklus läuft, an. Zeigen Tag, Monat und Uhrzeit des Zyklusendes an, wenn der automatische Zyklus läuft.</i></p>

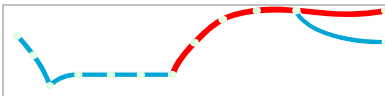

Anzeige des Vorschubzustands des ausgewählten Zyklus.
 Die zu den bereits abgeschlossenen Phasen gehörigen LED bleiben während der Ausführung der folgenden Phasen eingeschaltet.

Die Karte sieht die Möglichkeit voraus, **automatische** Zyklen einzustellen oder einen **manuellen** Zyklus durchzuführen.

Manueller Zyklus: Einstellung der 3 Phasen:
 KÜHLUNG, ERWÄMUNG UND KLIMATISIERUNG

Automatische Zyklen: (7 eingestellte und/oder abänderbare Zyklen) aus folgenden Phasen bestehend:
 GÄRBLOCKIERUNG, KONSERVIERUNG, ERWECKEN, GÄRUNG UND VERZÖGERUNG

INGANGSETZEN

Gehen Sie zum Einschalten des Gerätes wie folgt vor:

- Der Stecker in die Steckdose einfügen. (50)
- Gehen Sie zum Einschalten des Gerätes wie folgt vor. (51)
- Taste  drücken;

Auf dem Display angezeigt

02/01/2009
 Di 17:35

BESCHICKUNG DES PRODUKTES



- Jetzt and nicht vorher darf man die Waren in den Kühlschrank einführen.
- Das Produkt im Inneren der Zelle gleichmäßig verteilen, um eine gute Luftzirkulation zu ermöglichen.
- Die Stauung der Kühlschrankslüftung ist zu vermeiden. Im Inneren der Zelle sind Aufkleber angebracht, die max. Beschickungshöhe der Roste anzeigen.
- Die Tür während der Entnahme bzw. der Beschickung von Nahrungsmitteln nicht länger als notwendig offen lassen.
- Es ist ratsam, die Schlüssel außerhalb der Reichweite von Kindern aufzubewahren.

BETRIEB







MANUELLER ZYKLUS

Der manuelle Zyklus besteht aus 3 unabhängigen Phasen und der Übergang von einer Phase zur anderen erfolgt **nicht automatisch**.













KÜHLPHASE

	Die Taste <u>Menu</u> drücken, um das gewünschte Menu auszuwählen
	<u>Up</u> und <u>Down</u> Tasten benutzen um anzuzeigen
	<u>Enter</u> -Taste drücken, um die Wahl zu bestätigen



Menu 01
 Manuell

	<u>Up</u> und <u>Down</u> Tasten benutzen um anzuzeigen Manuell Kühlung
	<u>Enter</u> -Taste drücken, um die Wahl zu bestätigen. Wird angezeigt Kühlung T=25°C
	Die <u>Enter</u> -Taste drücken, um in den Modus der Veränderung der Sollwerte zu gelangen. <i>Der Sollwert der Temperatur blinkt, mit den Tasten  und  den Wert modifizieren.</i>
	Die <u>Enter</u> -Taste drücken, um den neuen Wert zu bestätigen
	Die <u>Start/Stop</u> -Taste drücken, um die ausgewählte Phase sofort zu aktivieren. Wird angezeigt Manuell 13:39 T=5°C

ERWÄRMUNGSPHASE

	Die Taste <u>Menü</u> drücken, um das gewünschte Menu auszuwählen
	<u>Up</u> und <u>Down</u> Tasten benutzen um anzuzeigen Menu 01 Manuell
	<u>Enter</u> -Taste drücken, um die Wahl zu bestätigen
	<u>Up</u> und <u>Down</u> Tasten benutzen um anzuzeigen Manuell Erwärmung
	<u>Enter</u> -Taste drücken, um die Wahl zu bestätigen. Wird angezeigt Erwärmung T=25°C UR=80%
	Die <u>Enter</u> -Taste drücken, um in den Modus der Veränderung der Sollwerte zu gelangen. <i>Der Sollwert der Temperatur blinkt, mit den Tasten  und  den Wert modifizieren.</i>
	Die <u>Enter</u> -Taste drücken, um den neuen Wert zu bestätigen. <i>Der Sollwert der Feuchtigkeit blinkt, mit den Tasten  und  den Wert modifizieren.</i>
	Die <u>Enter</u> -Taste drücken, um den neuen Wert zu bestätigen
	Die <u>Start/Stop</u> -Taste drücken, um die ausgewählte Phase sofort zu aktivieren. Wird angezeigt Manuell 13:39 T=5°C %rH=63%

KLIMATISIERUNGSPHASE

	Die Taste <u>Menü</u> drücken, um das gewünschte Menü auszuwählen
	<u>Up</u> und <u>Down</u> Tasten benutzen um anzuzeigen Menu 01 Manuell
	<u>Enter</u> -Taste drücken, um die Wahl zu bestätigen
	<u>Up</u> und <u>Down</u> Tasten benutzen um anzuzeigen Manuell Klimatisierung
	<u>Enter</u> -Taste drücken, um die Wahl zu bestätigen. Wird angezeigt Klimatisierung T=25°C UR=80%
	Die <u>Enter</u> -Taste drücken, um in den Modus der Veränderung der Sollwerte zu gelangen. Der Sollwert der Temperatur blinkt, mit den Tasten  und  den Wert modifizieren.
	Die <u>Enter</u> -Taste drücken, um den neuen Wert zu bestätigen. Der Sollwert der Feuchtigkeit blinkt, mit den Tasten  und  den Wert modifizieren.
	Die <u>Enter</u> -Taste drücken, um den neuen Wert zu bestätigen
	Die <u>Start/Stop</u> -Taste drücken, um die ausgewählte Phase sofort zu aktivieren. Wird angezeigt Manuell 13:39 T=5°C %rH=63%

AUTOMATISCHER ZYKLUS

Die Elektrokarte hat 7 automatische Zyklen wie folgt gespeichert:

GERÄTE -5°C / +30°C

ZYKLUS		P1	P2	P3	P4	P5	P6	P7
		Montag	Dienstag	Mittwoch	Donnerstag	Freitag	Samstag	Sonntag
GÄRSTOPP	Dauer	02:00	02:00	02:00	02:00	02:00	02:00	02:00
	Temperatur	-5°C	-5°C	-5°C	-5°C	-5°C	-5°C	-5°C
KONSERVIERUNG	Temperatur	-1°C	-1°C	-1°C	-1°C	-1°C	-1°C	-1°C
ERWECKUNG	Dauer	02:00	02:00	02:00	02:00	02:00	02:00	02:00
	Temperatur	20°C	20°C	20°C	20°C	20°C	20°C	20°C
	Feuchtigkeit	70%	70%	70%	70%	70%	70%	70%
GÄRUNG	Dauer	02:00	02:00	02:00	02:00	02:00	02:00	02:00
	Temperatur	28°C	28°C	28°C	28°C	28°C	28°C	28°C
	Feuchtigkeit	80%	80%	80%	80%	80%	80%	80%
PROGRAMMENDE	Stunde	01:00	01:00	01:00	01:00	01:00	01:00	01:00
GÄRSTOPP	Temperatur	6°C	6°C	6°C	6°C	6°C	6°C	6°C
	Feuchtigkeit	80%	80%	80%	80%	80%	80%	80%

GERÄTE -18°C / +30°C

ZYKLUS		P1	P2	P3	P4	P5	P6	P7
		Montag	Dienstag	Mittwoch	Donnerstag	Freitag	Samstag	Sonntag
GÄRSTOPP	Dauer	02:00	02:00	02:00	02:00	02:00	02:00	02:00
	Temperatur	-20°C	-20°C	-20°C	-20°C	-20°C	-20°C	-20°C
KONSERVIERUNG	Temperatur	-1°C	-1°C	-1°C	-1°C	-1°C	-1°C	-1°C
ERWECKUNG	Dauer	02:00	02:00	02:00	02:00	02:00	02:00	02:00
	Temperatur	20°C	20°C	20°C	20°C	20°C	20°C	20°C
	Feuchtigkeit	70%	70%	70%	70%	70%	70%	70%
GÄRUNG	Dauer	02:00	02:00	02:00	02:00	02:00	02:00	02:00
	Temperatur	28°C	28°C	28°C	28°C	28°C	28°C	28°C
	Feuchtigkeit	80%	80%	80%	80%	80%	80%	80%
PROGRAMMENDE	Stunde	01:00	01:00	01:00	01:00	01:00	01:00	01:00
GÄRSTOPP	Temperatur	6°C	6°C	6°C	6°C	6°C	6°C	6°C
	Feuchtigkeit	80%	80%	80%	80%	80%	80%	80%





GERÄTE -2°C / +30°C

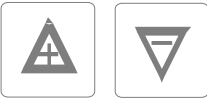

ZYKLUS		P1	P2	P3	P4	P5	P6	P7
		Montag	Dienstag	Mittwoch	Donnerstag	Freitag	Samstag	Sonntag
GÄRSTOPP	Dauer	02:00	02:00	02:00	02:00	02:00	02:00	02:00
	Temperatur	-2°C	-2°C	-2°C	-2°C	-2°C	-2°C	-2°C
KONSERVIERUNG	Temperatur	+2°C	+2°C	+2°C	+2°C	+2°C	+2°C	+2°C
ERWECKUNG	Dauer	02:00	02:00	02:00	02:00	02:00	02:00	02:00
	Temperatur	20°C	20°C	20°C	20°C	20°C	20°C	20°C
	Feuchtigkeit	70%	70%	70%	70%	70%	70%	70%
GÄRUNG	Dauer	02:00	02:00	02:00	02:00	02:00	02:00	02:00
	Temperatur	28°C	28°C	28°C	28°C	28°C	28°C	28°C
	Feuchtigkeit	80%	80%	80%	80%	80%	80%	80%
PROGRAMMENDE	Stunde	01:00	01:00	01:00	01:00	01:00	01:00	01:00
GÄRSTOPP	Temperatur	6°C	6°C	6°C	6°C	6°C	6°C	6°C
	Feuchtigkeit	80%	80%	80%	80%	80%	80%	80%

*Merken Sie: Höchsttemperatur des Teiges 27°C – Mehl vxx 320 – 0,01 Hefe hinzufügen – den gesalzenen Produkten und den Süßprodukten 0,01 Salz bzw. Zucker hinzufügen

Jeder automatische Zyklus besteht aus 5 Phasen:











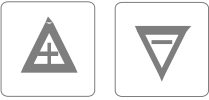
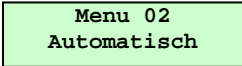

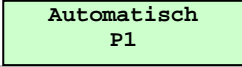







Der Zyklus beginnt immer bei der *GÄRUNGSBLOCKIERUNG* und der Übergang zu den folgenden Phasen erfolgt **automatisch** aufgrund von der Dauer jeder einzelnen Phase und vom Tag und Enduhrzeit des eingestellten Zyklus.

	Die Taste <u>Menü</u> drücken, um das gewünschte Menü auszuwählen
	<u>Up</u> und <u>Down</u> Tasten benutzen um anzuzeigen Menu 02 Automatisch
	<u>Enter</u> -Taste drücken um in die Auswahl der bereits gespeicherten Programme zu gelangen (P01... P07). Wird angezeigt Automatisch P1
	Mit den Tasten <u>up</u> und <u>down</u> das gewünschte Programm auswählen
	Die <u>Enter</u> -Taste drücken. Wird angezeigt Prog Ende Mo 03/02/09

Wenn das angezeigte Enddatum das gewünschte ist, die Taste  zum Bestätigen drücken und die Ausführung des Zyklus starten, sonst die Taste  drücken, um das Datum des Zyklusende zu verändern.

MODIFIZIERUNG DES AUTOMATISCHEN ZYKLUS



Zur Abänderung der voreingestellten Zyklen folgende Anweisungen befolgen.



	Die Taste <u>Menü</u> drücken, um das gewünschte Menü auszuwählen
	<u>Up</u> und <u>Down</u> Tasten benutzen um anzuzeigen 
	<u>Enter</u> -Taste drücken um in die Auswahl der bereits gespeicherten Programme zu gelangen (P01... P07). Wird angezeigt 
	Mit den Tasten <u>up</u> und <u>down</u> das gewünschte Programm auswählen
	Die <u>Enter</u> -Taste drücken, um in den Einstellungsmodus des gewählten Programms zu gelangen
	Mit der <u>Down</u> -Taste kann man zwischen zwei Phase wechseln und auf dem Display wird die Zyklusphase mit den aktuellen Sollwerten angezeigt.
	Die <u>Enter</u> -Taste drücken, um den Wert zu modifizieren Der Wert der <i>Stunden</i> beginnt zu blinken. Mit Hilfe der Tasten  und  den Wert verändern.
	Die <u>Enter</u> -Taste zur Bestätigung des Wertes drücken, die Angabe blinkt nicht mehr. Der Wert der <i>Minuten</i> beginnt zu blinken. Mit Hilfe der Tasten  und  den Wert verändern.
	Die <u>Enter</u> -Taste zur Bestätigung des Wertes drücken, die Angabe blinkt nicht mehr. Der <i>Temperatursollwert</i> beginnt zu blinken. Mit Hilfe der Tasten  und  den Wert verändern.
	Die <u>Enter</u> -Taste zur Bestätigung des Wertes drücken, die Angabe blinkt nicht mehr. Der <i>Feuchtigkeitssollwert</i> beginnt zu blinken (wenn vorhanden). Mit Hilfe der Tasten  und  den Wert verändern.
	Die <u>Enter</u> -Taste zur Bestätigung des Wertes drücken, die Angabe blinkt nicht mehr. Mit Hilfe der Tasten  und  die anderen Phasen auswählen und die Sollwerte verändern.

Durch Drücken der Taste  wird das Programm abgespeichert und man kehrt zum vorigen Menü zurück.

Durch Drücken der Taste  startet man hingegen das Programm und auf dem Display wird das Datum des

Zyklusende angezeigt 

Wenn das angezeigte Enddatum das gewünschte ist, die Taste  zum Bestätigen drücken und die Ausführung des Zyklus starten, sonst die Taste  drücken, um das Datum des Zyklusende zu verändern.

Der Tag links, mit der Taste  das Datum des Programmendes verändern, mit der Taste  das neue Datum bestätigen und mit der Taste  den Zyklus starten.

AUSFÜHRUNG EINES AUTOMATISCHEN ZYKLUS

Während der Ausführung eines automatischen Zyklus wird auf dem Display angezeigt:

P2 Blockierung
T=19°C

Anzeigen der Nummer des laufenden Programms, der laufenden Phase, der aktuellen Zelltemperatur und, wenn die Phase auch Befeuchtung durch eine Sonde vorsieht, der Prozentsatz der vorhandenen Feuchtigkeit.

Anzeige von Datum und Uhrzeit der Phasen

Die Taste  drücken, um Datum und Uhrzeit der laufenden Phase anzuzeigen.

Die Taste  drücken, um Datum und Uhrzeit der folgenden Phasen anzuzeigen.

Wird angezeigt

Ende PH0 09:00
Mo 03/04/09

PH0 zeigt an, dass die Phase 0 läuft, genauer die Gärstoppphase

Die anderen Phasen werden angezeigt mit:

PH 1 zeigt die Konservierung an

PH 2 zeigt des Erweckung an

PH 3 zeigt die Gärung an

PH 4 zeigt die Verzögerung an

Durch Drücken der Taste , oder nach einem Timeout von 5 Sekunden, erscheint wieder die vorherige Anzeige.

Anzeigen des Status INPUT/OUTPUT

Die Taste  drücken, um den Status der INPUT/OUTPUT anzuzeigen.

C D E R V H U
1 0 0 1 1 0 0

Durch Drücken der Taste , oder nach einem Timeout von 20 Sekunden, erscheint wieder die vorherige Anzeige.

Datum und Uhrzeit anzeigen

Die Taste  drücken, um das Datum und die Uhrzeit anzuzeigen.







08/02/2007
Di 17:35

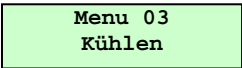

Durch Drücken der Taste , oder nach einem Timeout von 5 Sekunden, erscheint wieder die vorherige Anzeige.

Das Drücken der Taste  hält zu jedem Zeitpunkt den Zyklus an. Der Zyklus bleibt aber ausgewählt.

VORKÜHLUNGSZYKLUS

Es wird geraten, vor Auswahl eines Zyklus, stets zunächst einen Abkühlzyklus auszuwählen.

	Die Taste <u>Menü</u> drücken, um das gewünschte Menu auszuwählen
 	<u>Up</u> und <u>Down</u> Tasten benutzen um anzuzeigen 
	Die <u>Enter</u> -Taste drücken, um in den Modus der Veränderung der Sollwerte zu gelangen. Der Sollwert der Temperatur blinkt, mit den Tasten  und  den Wert modifizieren.

	Die <u>Enter</u> -Taste drücken, um den neuen Wert zu bestätigen				
	Die Taste <u>Start/Stop</u> drücken, um den Abkühlungszyklus umgehend zu aktivieren Wird angezeigt <table border="1" data-bbox="678 340 917 407"><tr><td>Kühlen</td><td>06:18</td></tr><tr><td>T=-6°C</td><td></td></tr></table>	Kühlen	06:18	T=-6°C	
Kühlen	06:18				
T=-6°C					

Durch Drücken der Taste  kann man zur Veränderung der Sollwerte zurückkehren.

ANHALTEN



Die Apparatur kann unter jeder Bedingung beim Drücken einer Taste gestoppt werden  ;
auf dem Display wird angezeigt

OFF	_
-----	---

ACHTUNG: Die Taste  isoliert das Gerät NICHT von der elektrischen Spannung.

Um das Gerät von der elektrischen Spannung zu isolieren Stecker aus der Steckdose herausziehen.





ENTFROSTUNG



	Die Taste <u>Menü</u> drücken, um das gewünschte Menu auszuwählen		
	<u>Up</u> und <u>Down</u> Tasten benutzen um anzuzeigen <table border="1" data-bbox="997 1153 1236 1220"><tr><td>Menu 04</td></tr><tr><td>Abtauung</td></tr></table>	Menu 04	Abtauung
Menu 04			
Abtauung			
	<u>Enter</u> -Taste drücken um in die Abtaustartanfrage zu gelangen Wird angezeigt <table border="1" data-bbox="683 1303 949 1361"><tr><td>Start?</td></tr><tr><td>Nein Ja</td></tr></table>	Start?	Nein Ja
Start?			
Nein Ja			

Die Taste  drücken, um das Menü zu verlassen und den Abtauvorgang nicht zu starten.







Die Taste  drücken, um einen Abtauvorgang zu starten.

EINSTELLEN DER UHR







	Die Taste <u>Menü</u> drücken, um das gewünschte Menu auszuwählen				
	<u>Up</u> und <u>Down</u> Tasten benutzen um anzuzeigen <table border="1" data-bbox="997 1760 1236 1827"><tr><td>Menu 05</td></tr><tr><td>Uhr Einstellen</td></tr></table>	Menu 05	Uhr Einstellen		
Menu 05					
Uhr Einstellen					
	<u>Enter</u> -Taste drücken, um in den Uhrzeiteinstellungsmodus zu gelangen. Wird angezeigt <table border="1" data-bbox="683 1910 949 1968"><tr><td>Mo</td><td>16/11/06</td></tr><tr><td></td><td>14:22:46</td></tr></table> Mit Hilfe der Tasten  und  die blinkende Ziffer verändern	Mo	16/11/06		14:22:46
Mo	16/11/06				
	14:22:46				

	Enter Taste drücken, um den Wert zu bestätigen und auf die darauffolgenden Daten rüberzugehen
	<u>Menu</u> -Taste drücken um aus dem Auswahlprogramm zu gehen

EINSTELLEN DER SOMMERZEIT











	Die Taste <u>Menu</u> drücken, um das gewünschte Menu auszuwählen
	<u>Up</u> und <u>Down</u> Tasten benutzen um anzuzeigen Menu 06 Sommerzeit
	Die <u>Enter</u> -Taste drücken, um in den Modus für die Einstellung der Sommerzeit zu gelangen. Wird angezeigt So 17:52 +1
	Mit den Tasten  und  die Uhrzeit verändern
	Die <u>Enter</u> -Taste drücken, um den neuen Wert zu bestätigen
	<u>Menu</u> -Taste drücken um aus dem Auswahlprogramm zu gehen

SPRACHE

	Die Taste <u>Menu</u> drücken, um das gewünschte Menu auszuwählen
	<u>Up</u> und <u>Down</u> Tasten benutzen um anzuzeigen Menu 07 Sprache
	Die <u>Enter</u> -Taste drücken, um die aktuell verwendete Sprache anzuzeigen. Wird angezeigt Sprache Deutsch
	<u>Up</u> und <u>Down</u> Tasten benutzen, um die gewünschte Sprache anzuzeigen
	<u>Enter</u> -Taste drücken, um die Wahl zu bestätigen
	<u>Menu</u> -Taste drücken um aus dem Auswahlprogramm zu gehen

PARAMETER

Parameter-änderung

	Die Taste <u>Menü</u> drücken, um das gewünschte Menu auszuwählen
	<u>Up</u> und <u>Down</u> Tasten benutzen um anzuzeigen Menu 08 Einstellen
	<u>Enter</u> -Taste drücken, um die Wahl zu bestätigen. Wird angezeigt Einstellen Password 0
	<u>Up</u> und <u>Down</u> Tasten benutzen um das Passwort "-19" auszuwählen
	<u>Enter</u> -Taste drücken, um die Wahl zu bestätigen. Es wird das erste Untermenü angezeigt Einstellen 01 Parameter
	<u>Enter</u> -Taste drücken um in den Programmierungsmodus der Parameter zu gelangen Der erste Parameter wird angezeigt P01=-5°C
	<u>Up</u> und <u>Down</u> Tasten benutzen um die sämtlichen Programme des Controllers zu durchlaufen
	<u>Enter</u> -Taste drücken, um die Wahl zu bestätigen
	<u>Up</u> und <u>Down</u> Tasten benutzen um den neuen Parameterwert auszuwählen
	<u>Enter</u> -Taste drücken, um die Wahl zu bestätigen
	<u>Menu</u> -Taste drücken um aus dem Auswahlprogramm zu gehen

Beschreibung der parameter

Nr.	Beschreibung	Default -2/+30°C	Default -5/+30°C	Default -18/+30°C	Min	Max	Einheit
Allgemeine Einstellungen							
P1	Auswahl Anzeige bei Power on 0 = keine 1 = EVCO s.r.l.	1	1	1	0	1	---
P2	0 = Celsius 1 = Fahrenheit	0	0	0	0	1	---
P3	Offset Zellensonde	0	-2	-2	-15	15	°C/°F
P4	Offset Sonde Evaporator	0	0	0	-15	15	°C/°F
P5	Untergrenze Feuchtigkeitssonde	0	0	0	0	P6	%
P6	Obergrenze Feuchtigkeitssonde	100	100	100	P5	200	%
P7	Eingangspolarität für den Türkontakt 0 = NO 1 = NC	0	0	0	0	1	---









Nr.	Beschreibung	Default -2/+30°C	Default -5/+30°C	Default -18/+30°C	Min	Max	Einheit
P8	BT Eingangspolarität für den Thermostat 0 = NO 1 = NC	0	0	0	0	1	---
P9	Dauer Power down für Wiederaufnahme automatisches Programm	15	15	15	1	60	Minuten
P10	Auswahl Verhalten nach power down für automatisches Programm 0= ein automatischer Zyklus startet nur wieder, wenn das Power down kleiner als P9 Minuten ist 1= ein automatischer Zyklus startet immer wieder	1	1	1	1	1	---
P11	Dauer Power down für Wiederaufnahme manuelles Programm	15	15	15	1	60	Minuten
P12	Auswahl Verhalten nach Power down für manuelles Programm 0 = ein manueller Zyklus startet nur wieder, wenn das Power down kleiner als P11 Minuten ist 1 = ein manueller Zyklus startet immer wieder	1	1	1	0	1	---
Setpoint							
P13	Min einstellender Abkühlungs-Fixpunkt	-2	-5	-24	-30	P14	°C/°F
P14	Max einstellender Abkühlungs-Fixpunkt	10	10	5	P13	90	°C/°F
P15	Abkühlungs-Hysterese	2	2	2	1	10	°C/°F
P16	Tote Zone kalt für Abkühlung, Gärstopp und Konservierung	0	0	0	0	10	°C/°F
P17	Tote Zone kalt für Erwärmung, Erweckung und Gärung	0	0	0	0	10	°C/°F
P18	Tote Zone kalt für Klimatisierung und Verzögerung	0	0	0	0	10	°C/°F
P19	Min einstellender Erwärmungs-Fixpunkt	5	5	5	0	P20	°C/°F
P20	Max einstellender Erwärmungs-Fixpunkt	30	30	30	P19	90	°C/°F
P21	Erwärmungs-Hysterese	1	1	1	1	10	°C/°F
P22	Tote Zone warm für Erwärmung, Erweckung und Gärung	1	1	1	0	10	°C/°F
P23	Tote Zone warm für Klimatisierung und Verzögerung	1	1	1	0	10	°C/°F
P24	Abstandzahl Widerstandreglung bei Erweckung	9	9	9	1	10	---
P25	Abstandzahl Widerstandreglung bei Gärung	1	1	1	1	10	---
Zeiten Kompressor							
P26	Verspätung zwischen zwei darauf folgenden ON des Kompressors	3	3	3	0	60	Minuten
P27	Verspätung zwischen einem OFF und einem darauf folgenden ON des Kompressors	2	2	2	0	60	Minuten
P28	Kompressoreinschaltverspätung Power on	1	1	1	0	255	Minuten
P29	Dauer Zwangsstart Kompressor am Anfang der Phasen Erwecken, Gärung und Verzögerung	0	0	0	0	60	Minuten
Zeiten Widerstände							
P30	Mindestzeit Aktivierung Widerstände	0	0	0	0	255	Sekunden
Befeuchtung und Entfeuchtung							
P31	Untergrenze der Zelltemperatur für Befeuchtung/Entfeuchtung	5	5	5	0	90	°C/°F
P32	Feuchtigkeitsverwaltungsmodus 0 = mit Feuchtigkeitszone 1 = auf Zeitzyklus aufgrund vom eingestellten Prozentsatz 2 = auf Abstände von einer Minute	0	0	0	0	2	---
P33	Pausezeit falls P32 = 2	10	10	10	0	60	Minuten
P34	Feuchtigkeitszyklusdauer falls P32 = 1	60	60	60	30	600	Sekunden
P35	Feuchtigkeitshöchstdauer falls P32 = 1	30	30	30	0	P34	Sekunden
P36	Aktiviert die Befeuchtung in den Phasen Gärstopp und Konservierung 0 = deaktiviert 1 = aktiviert	0	0	0	0	1	---
P37	Hysterese für Feuchtigkeit	1	1	1	1	100	%
P38	Tote Zone für Feuchtigkeit	4	4	4	0	100	%
P39	Band Proportionaleinstellung für Befeuchtung	4	4	4	0	20	%
P40	Zykluszeit für Proportionaleinst. Befeuchtung	1	1	1	1	255	Sekunden Minuten
P41	Grundzeiten für Zykluszeit 0 = Sekunden 1 = Minuten	1	1	1	0	1	---
P42	Hysterese für Entfeuchtung	1	1	1	1	100	%
P43	Tote Zone für Entfeuchtung	5	5	5	0	100	%
P44	Dauer Versuch Entfeuchtung mit Elektroventil	1	1	1	1	255	Sekunden
Lüftung							
P45	Aktivierung Proportionaleinstellung Lüfter Evaporator 0 = Einstellung on/OFF 1 = Proportionaleinstellung	0	0	0	0	1	---
P46	Verdampfergebläsebetrieb für die Gärungsblockierung 0 = Parallelbetrieb 1 = stetiger Betrieb	1	1	1	0	1	---

Nr.	Beschreibung	Default -2/+30°C	Default -5/+30°C	Default -18/+30°C	Min	Max	Einheit
P47	Verdampfergebläsebetrieb für die Konservierung 0 = Parallelbetrieb 1 = stetiger Betrieb	1	1	1	0	1	---
P48	Verdampfergebläsebetrieb für die Erweckung 0 = Parallelbetrieb 1 = stetiger Betrieb	0	0	0	0	1	---
P49	Verdampfergebläsebetrieb für die Gärung 0 = Parallelbetrieb 1 = stetiger Betrieb	0	0	0	0	1	---
P50	Verdampfergebläsebetrieb für die Verzögerung 0 = Parallelbetrieb 1 = stetiger Betrieb	0	0	0	0	1	---
P51	Verdampfergebläsebetrieb für die Kühlung 0 = Parallelbetrieb 1 = stetiger Betrieb	1	1	1	0	1	---
P52	Verdampfergebläsebetrieb für die Erwärmung 0 = Parallelbetrieb 1 = stetiger Betrieb	0	0	0	0	1	---
P53	Verdampfergebläsebetrieb für die Klimatisierung 0 = Parallelbetrieb 1 = stetiger Betrieb	0	0	0	0	1	---
P54	Abschalteverspätung Verdampfergebläse in Parallelbetrieb	1	1	1	0	255	Minuten
P55	Verdampfergebläsearbeitszeit falls in Parallelbetrieb	1	1	1	0	255	Minuten
P56	Verdampfergebläsepausezeit falls in Parallelbetrieb	1	1	1	0	255	Minuten
P57	Minimale Geschwindigkeit Ventilator Evaporator	0	0	0	0	P58	%
P58	Maximale Geschwindigkeit Ventilator Evaporator	100	100	100	P57	100	%
P59	Minimale Geschwindigkeit Ventilator während der Entfeuchtung	20	20	20	P57	P58	%
Entfrostsung							
P60	Temperatur Evaporator für das Ende des Abtauens	8	8	8	-40	99	°C
P61	Pause zwischen zwei darauf folgende Abtauvorgänge 0 = der Abtauvorgang wird nicht wiederholt	8	8	6	0	10	ore
P62	Höchstdauer Abtauzyklus	10	10	30	1	120	Minuten
P63	Abtropfzeit	2	2	3	0	30	Minuten
P64	Gebläsezustand während des Abtauvorgangs	0	0	0	0	1	---
P65	Gebläseblockierungsdauer nach dem Abtropfen	2	2	2	0	15	Minuten
Kühlung							
P66	Minimaler Sollwert Kühlung	-2	-5	-5	-30	P67	°C
P67	Maximaler Sollwert Kühlung	10	10	10	P66	30	°C
P68	Preset Kühlung	-2	-5	-5	P66	P67	°C
Programmeinstellung und -veränderung							
P69	Aktivierung Programmeinstellung	1	1	1	0	1	---
P70	Aktivierung Programmveränderung	1	1	1	0	1	---
P71	Verwaltung K3: 0=Elektroventil; 1=Licht; 2=Entfeuchtung	1	1	1	0	2	---
P72	Verwaltung Kompressor bei Offener Tür: 0= keine Auswirkung; 1 = Kompressor schaltet sich aus	0	0	0	0	1	---
P73	Art des Abtauens: 0= Widerstand; 1=Heißes Gas	0	0	0	0	1	---
P74	Alarm hohe Temperatur Evaporator	55	55	55	0	70	°C
P75	Aktivierung Alarm hohe Temperatur Evaporator: 0=nicht aktiviert; 1 = aktiviert	1	1	1	0	1	---
P76	Aktivierung der Entfeuchtung 0=deaktiviert 1=aktiv. bei Erweckung, Gärung, Verzögerung, Klimatisierung, Erwärmung 2=aktiviert auch bei Gärstopp und Konservierung	0	0	0	0	2	---
P77	Widerstandszeit ON	3	3	3	1	255	Sekunden Minuten
P78	Widerstandszeit OFF (0= Widerstände immer an)	1	1	1	0	255	Sekunden Minuten





Nota



- Kontrollieren, dass die Schutzzeiten des Kompressors, da Default sind sie immer auf Null gestellt.
- Die Parameter P5 und P6 werden benutzt, um die Reichweite der Feuchtigkeitssonde zu definieren. Der Parameter P5 muss zum gleichen Feuchtigkeitsprozentatz entsprechend 4mA gestellt werden und der Parameter P6 muss zum gleichen Feuchtigkeitsprozentatz entsprechend 20mA gestellt werden.
- Nach einer Abänderung am Parameter P32 Feuchtigkeitsfixpunkt der automatischen und manuellen Programme prüfen.

EINGANG/AUSGANG

	Die Taste <u>Menü</u> drücken, um das gewünschte Menu auszuwählen																
	<u>Up</u> und <u>Down</u> Tasten benutzen um anzuzeigen Menu 08 Einstellen																
	<u>Enter</u> -Taste drücken, um die Wahl zu bestätigen. Wird angezeigt Einstellen Password 0																
	<u>Up</u> und <u>Down</u> Tasten benutzen um das Passwort "-19" auszuwählen																
	<u>Enter</u> -Taste drücken, um die Wahl zu bestätigen. Es wird das erste Untermenü angezeigt Einstellen 01 Parameter																
	<u>Up</u> und <u>Down</u> Tasten benutzen um anzuzeigen Einstellen 02 Eingang/Ausgang																
	Enter Taste drücken um in den Anzeigemodus der Ein- und Ausgänge zu gelangen Wird angezeigt Zelle -6°C Verd -15°C																
	Up und Down Tasten benutzen um die Anzeigen zu durchlaufen <div style="display: flex; align-items: flex-start;"> <div style="margin-right: 20px;"> Zelle -6°C Verd 15°C Feuchtigkeit 14% C D E R V H U 1 0 0 1 1 0 0 DI1 DI2 FAN 0 1 98 </div> <div> <p>Temperaturwert der Zelle und des Verdampfers</p> <p>Wert Sonde Feuchtigkeit</p> <p>Ausgangszustand: 1 = Relais betätigt 0 = Relais unbetätigt</p> <p>Digitaleingangszustand und Geschwindigkeit der</p> <table border="1" style="font-size: small;"> <tr><td>C</td><td>Kompressor</td><td>V</td><td>Lüfter</td></tr> <tr><td>D</td><td>Defrost</td><td>H</td><td>Dampferzeug.</td></tr> <tr><td>EV</td><td>Beleucht.Entf.</td><td>U</td><td>Befeuchter</td></tr> <tr><td>R</td><td>Widerstände</td><td></td><td></td></tr> </table> </div> </div>	C	Kompressor	V	Lüfter	D	Defrost	H	Dampferzeug.	EV	Beleucht.Entf.	U	Befeuchter	R	Widerstände		
C	Kompressor	V	Lüfter														
D	Defrost	H	Dampferzeug.														
EV	Beleucht.Entf.	U	Befeuchter														
R	Widerstände																
	<u>Menu</u> -Taste drücken um aus dem Auswahlprogramm zu gehen																

WIEDERHERSTELLUNG DER DEFAULT-PARAMETER

	Die Taste <u>Menü</u> drücken, um das gewünschte Menu auszuwählen
	<u>Up</u> und <u>Down</u> Tasten benutzen um anzuzeigen Menu 08 Einstellen
	<u>Enter</u> -Taste drücken, um die Wahl zu bestätigen. Wird angezeigt Einstellen Password 0
	<u>Up</u> und <u>Down</u> Tasten benutzen um das Passwort "-19" auszuwählen







	<u>Enter</u> -Taste drücken, um die Wahl zu bestätigen. Es wird das erste Untermenü angezeigt Einstellen 01 Parameter
	<u>Up</u> und <u>Down</u> Tasten benutzen um anzuzeigen Einstellen 03 Wiederherstellen
	Beim Drücken der Enter Taste wird das Löschen der im Speicher aufgezeichneten Daten angefragt. Wird angezeigt Wiederherstellen? Nein Ja

Die Taste  drücken, um das Menü zu verlassen und keine Wiederaufnahme durchzuführen

Die Taste  drücken, um die originalen Defaultparameter wiederherzustellen.

Die Taste  drücken um aus dem Auswahlprogramm zu gehen.

VERSTELLGESCHWINDIGKEIT FANS

	Die Taste <u>Menü</u> drücken, um das gewünschte Menu auszuwählen
	<u>Up</u> und <u>Down</u> Tasten benutzen um anzuzeigen Menu 08 Einstellen
	<u>Enter</u> -Taste drücken, um die Wahl zu bestätigen. Wird angezeigt Einstellen Password 0
	<u>Up</u> und <u>Down</u> Tasten benutzen um das Passwort "-19" auszuwählen
	<u>Enter</u> -Taste drücken, um die Wahl zu bestätigen. Es wird das erste Untermenü angezeigt Einstellen 01 Parameter
	<u>Up</u> und <u>Down</u> Tasten benutzen um anzuzeigen Einstellen 04 Min Max Gebläse
	Die <u>Enter</u> -Taste drücken, um in den Einstellmodus der Ventilatorgeschwindigkeit zu wechseln. Wird angezeigt Min. Geschwind 0%
	Die <u>Enter</u> -Taste drücken, um den Wert zu modifizieren. Der Wert beginnt zu blinken. Mit Hilfe der Tasten  und  den Wert verändern.
	Die <u>Enter</u> -Taste drücken, um den neuen Wert zu bestätigen. Wird angezeigt Max. Geschwind 100% Mit Hilfe der Tasten  und  den Wert verändern.
	Die <u>Enter</u> -Taste drücken, um den neuen Wert zu bestätigen.

MENU

Menu-Taste drücken um aus dem Auswahlprogramm zu gehen

ALARME

Im Fall von Funktionsstörungen erscheinen visuelle und akustische Meldungen.

Zellensonde

Eine Störung an der Sonde löst einen Alarm der Zellensonde aus, der Buzzer ertönt und auf dem Display blinkt eine Fehlermeldung:

ALL Zellensonde

Der laufende Zyklus wird unterbrochen und alle Ausgänge werden deaktiviert.
Der Buzzer kann durch Drücken einer beliebigen Taste abgestellt werden.
Nach der Fehlerbehebung wird der Zyklus fortgesetzt.

Sicherheitsthermostat

Wenn der Alarm des Thermostats über die Karte ausgelöst wird, ertönt der Buzzer und auf dem Display erscheint der Alarm:

ALL Thermostat

Der laufende Zyklus wird unterbrochen und alle Ausgänge werden deaktiviert.
Der Buzzer kann durch Drücken einer beliebigen Taste abgestellt werden.

Nach der Fehlerbehebung die Taste  drücken, um die Karte wieder zu laden.

Evaporatorsonde

Eine Störung der Sonde löst einen Fehleralarm der Evaporatorsonde aus, der Buzzer ertönt und auf dem Display blinkt die Alarmmeldung:

ALLVerdampfSonde

Der laufende Zyklus wird unterbrochen und alle Ausgänge werden deaktiviert.
Der Buzzer kann durch Drücken einer beliebigen Taste abgestellt werden.
Nach der Fehlerbehebung wird der Zyklus fortgesetzt.

Hohe Temperatur Evaporator

Wenn die Evaporatorsonde den im Parameter P74 eingestellten Wert erreicht, wird der Alarm für die hohe Temperatur des Evaporators aktiviert. Der Buzzer ertönt und auf dem Display erscheint die Alarmmeldung:

ALL Hoch T Verd

Der laufende Zyklus wird unterbrochen und alle Ausgänge werden deaktiviert.
Der Buzzer kann durch Drücken einer beliebigen Taste abgestellt werden.

Nach der Fehlerbehebung die Taste  drücken, um die Karte wieder zu laden.

Feuchtigkeitassonde

Eine Störung der Sonde löst einen Fehleralarm der Feuchtigkeitssonde aus, der Buzzer ertönt und auf dem Display blinkt die Alarmmeldung:

ALLFeucht.-Sonde

Der laufende Zyklus wird unterbrochen und alle Ausgänge werden deaktiviert.
Der Buzzer kann durch Drücken einer beliebigen Taste abgestellt werden.
Nach der Fehlerbehebung wird der Zyklus fortgesetzt.

MicroTür

Jede Öffnung der Tür wird mit der blinkenden Meldung Tür Offen angezeigt:

Tür offen

Das Öffnen der Tür während eines Schnellkühlzyklus stoppt den Lüfter, die Widerstände und den Befeuchter; der Kompressor und der Dampferzeuger bleiben angeschaltet.
Der Buzzer ertönt, kann aber durch Drücken einer beliebigen Taste abgeschaltet werden und die Meldung endet automatisch beim Schließen der Tür.
Bei jedem Öffnen der Tür schaltet sich das Licht ein.

Funktionsstörung RTC

Wann immer sich eine Funktionsstörung am RTC herausstellt, wird ein RTC-Alarm ausgelöst; der Buzzer ertönt und auf dem Display blinkt die Alarmmeldung:

ALL RTC

Der laufende Zyklus wird unterbrochen und alle Ausgänge werden deaktiviert.
Der Buzzer kann durch Drücken einer beliebigen Taste ausgeschaltet werden.
Es ist möglich auf das Menü Einstellungen Uhr zuzugreifen und die aktuellen Werte des RTC einzustellen; danach kehrt die Karte auf Standby zurück.

EEPROM-Alarme

Wann immer sich eine Inkohärenz in den gespeicherten Daten des Eeprom herausstellt, wird eine Eeprom-Alarm ausgelöst; der Buzzer ertönt und auf dem Display blinkt die Alarmmeldung:

ALL EEprom

Der laufende Zyklus wird unterbrochen und alle Ausgänge werden deaktiviert.
Der Buzzer kann durch Drücken einer beliebigen Taste abgestellt werden.

Um die Karte wieder zu laden, die Taste  drücken. Danach kehrt die Karte in den Standby-Modus zurück.
Beachte: nach einem Eeprom-Alarm werden alle Parameter wieder auf den Default-Wert zurückgesetzt.

BETRIEB SONOMALIEN

Im Zufall von Anomalien, vorher man die technische Hilfe ruft, prüfen ob:

der Hauptschalter 1 leuchtet und Strom anwesend ist; (63)
die eingestellte Temperatur richtig ist; (65)
die Türen richtig geschlossen sind;
der Kühlschrank nicht bei Wärmequellen steht; (38)
der Kondensator sauber ist und der Lüfter funktioniert;
dass es keine übermäßige Eisblumenbildung auf der evaporierenden Batterie gibt.

Falls diese Kontrollen ein negatives Ergebnis gegeben hätten, sich bitte an den Kundendienst wenden und die Modellangaben, Kennnummer die auf dem Maschinenschild am Armaturenbrett aufgetragen sind, angeben.(11)

TGLICHE REINIGUNG

Damit eine perfekte Hygiene und eine Erhaltung des Kühlschranks (66) garantiert wird, sollten die folgenden Reinigungsverfahren ordentlich und/oder täglich durchgeführt werden:

Die Außenflächen des Apparates gründlich mit einem ins Wasser eingetauchten, sanften und ausgewringten Schwamm und säurefreien Reiniger putzen, und dies nur der Richtung des Satinierens nach. (67)
Das Reinigungsmittel darf kein Chlor enthalten und soll nicht abrasiv sein.(67)
Folgende Reinigungsmittel werden empfohlen:
Desinfektionsreiniger mit kombinierter Wirkung (die, nicht ionische grenzflächenaktive Stoffe, Chloridbenzal, Chelatsubstanzen und PH Puffer, enthalten)
säurefreie Laborreiniger , für manuelles Abwaschen (die, anionische und nicht ionische grenzflächenaktive Stoffe, enthalten)
Entfettungsmittel fürs Nahrungsmilieu (die, anionische grenzflächenaktive Stoffe und EDTA, enthalten)

Vor dem Gebrauch die Reinigungsmittel eventuell gemäß der auf das Etikett aufgetragenen Vorschriften verdünnen.

Die Reinigungsmittel mindestens 5 minutenlang einwirken lassen.
Die Kühlschränke mehrmals mit einem Schwamm und fließendem Wasser abspülen.(69)
Mit einem sauberen Schwamm sorgfältig abtrocknen.

ACHTUNG: absolut keine Werkzeuge die zerkratzen können mit herrührende Rostbildung, gebrauchen. (68)

Eventuelle Nahrungsflecken oder -reste im Inneren des Kühlschranks entfernen. (siehe folgender Abschnitt)

SPEISEFLECKEN UND GEHRTETEN RESTE

Falls im Kühlschrank Nahrungsflecken oder –reste anwesend sind, diese mit Wasser abwaschen und dann entfernen bevor sie härten.

Wenn die Reste schon gehärtet sind, wie folgt verfahren:

Einen ins lauwarme Wasser eingetauchten sanften Schwamm und säurefreien Reiniger benutzen (man kann diejenigen gebrauchen, die für das tägliche Putzen vorgesehen sind und zwar mit der höchsten Konzentration unter denen, die auf das Etikett vorgesehen sind). (72)

Den gehärteten Rückstand anfeuchten, indem man zirka alle 5 Minuten mit dem ins Wasser eingetauchten Schwamm und Reinigungsmittel über den gehärteten Schmutz wischt, um diesen somit wenigstens 30 minutenlang feucht zu halten.

Am Ende des Einweichens den Rückstand mit dem ins Wasser eingetauchten Schwamm und säurefreien Reinigungsmittel entfernen.

Wenn nötig, eine Holzspachtel oder eine rostfreie Stahllanzette benutzen und darauf achten, dass die Kühlschrankoberflächen nicht beschädigt werden. (70)

Am Endpunkt des Verfahrens sollte ein täglicher Reinigungskreislauf aller Innenflächen des Kühlschranks getätigt werden.

Am Ende der Reinigung mehrmals mit einem Schwamm und fließendem Wasser abspülen.

Mit einem sauberen Schwamm gründlich abtrocknen.

Auch der Boden unter und herum den Schrank muss sauber und in vollkommene Hygiene gehalten sein.

Mit Wasser und Seife oder neutralen Reinigungsmittel waschen. (71)

Die Bleche mit Silikonwachs schützen.

REINIGUNG UND PERIODISCHE WARTUNG

Zwecks einer konstanten Leistung des Apparates sollten periodische Reinigungs- und Wartungsvorgänge durchgeführt werden.

Bevor anzufangen vorgehen wie folgen:

der Netzschalter auf OFF stellen (16)

der Stecker von der Steckdose herausziehen und bis zur kompletter Entfrostung warten. (17)

Nachdem alle Schutzteile entfernt worden sind, den Kondensator der Kühlgruppe und den Verdampfer sorgfältig mit einem Staubsauger, Pinsel oder einer nichtmetallischen Bürste putzen. (73)

ACHTUNG:Die Reinigung und die Wartung der Kühlanlagen und des Kompressorenraumes verlangt der Eingriff von einem berechtigten Fachmann, dafür können sie nicht von unfähige Personen ausgeführt werden. (30)

Die Außen- und Innenflächen des Apparates nach den im Alltagsreinigungsabschnitt angegebenen Hinweisen putzen.

Die Kühlschränke mit "NORMALE TEMPERATUR" haben ein Abfluss im unteren Teil.

Kontrollieren, dass das Loch frei ist und eventuell reinigen. (75)

Nach der Öffnung der Verschlussplatte des Dampferzeuger-Sets, Dampfrohr abmontieren und mit fließendem Wasser entkalken. Boiler vom Set abmontieren und mit fließendem Wasser entkalken. Das Ganze wieder aufmontieren. (76a)

Die Reinigung und die allgemeine Wartung sind jetzt zu Ende.

BETRIEB UNTERBRECHUNGEN

Im Fall von längere Untätigkeit des Kühlschranks und um ihn am besten zu halten, sich benehmen wie folgendes:

- Der Netzschalter auf OFF stellen. (16)
- Der Stecker aus der Steckdose ziehen. (17)
- Der Kühlschrank leeren und putzen wie beschrieben im Kapitel "REINIGUNG". (76)
- Das im Dampferzeuger-Boiler vorhandene Wasser entleeren, nachdem die Rohrschelle entfernt und das Rohr herausgezogen wurden. (76a)
- Um die Bildung von schlechte Gerüche zu vermeiden, die Türe halboffen lassen. (77)
- Die Kompressorgruppe mit einem Nylonüberzug decken um ihn vom Staub zu schützen. (78)

WERTVOLLE RTE FR DIE PFLEGE DES ROSTFREIER STAHL

Die Kühltischanke sin aus ROSTFREIER STAHL AISI 304 gebaut. (79)
 Für die Reinigung und die Wartung der stahlernen Teilen, sich an folgendes halten, und bedenken dass die wichtigste Regel die Hygiene und Nichtgiftigkeit ist.
 Der rostfreier Stahl hat eine dünne Oxidschicht die den Rost vermeidet.
 Es gibt jedoch Stoffe, die diese Schicht zerstören können, und Korrosion verursachen.
 Vorher man irgendwelches Produkt gebraucht, immer sich beim Verkäufer erkundigen, welches Produkt am besten geeignet ist und keine Korrosion verursacht. (73)

Im Zufall von Kratzen muss man mit einem Schwamm aus feinen ROSTFREIEN STAHL oder mit einem abschleifenden synthetischen Schwamm in der Richtung der Satinierung reiben. (80)

ACHTUNG: für den ROSTFREIER STAHL nie eisene Schwämme gebrauchen, und sie nie auf den Flächen liegen lassen, weil Eisenreste durch Verunreinigung Rostbildungen bilden können. (81)

BETRIEBSSTÖRUNGEN

Häufig sind auftretende Betriebsstörungen auf banale Ursachen zurückzuführen, die praktisch immer ohne die Intervention eines spezialisierten Technikers zu beheben sind. Daher ist vor der Signalisierung eines Defektes an den Kundendienst folgendes zu überprüfen:

PROBLEM	MÖGLICHE URSACHEN
Das Gerät schaltet sich nicht ein	Überprüfen, ob der Stecker korrekt in die Steckdose eingesteckt ist
	Überprüfen, ob die Steckdose mit Strom versorgt ist
Die Innentemperatur ist zu hoch	Reglung der Elektronikarte
	Überprüfen, ob kein Einfluß einer Wärmequelle besteht
	Überprüfen, ob die Tür einwandfrei geschlossen ist
Das Gerät ist zu laut	Die Ausrichtung des Gerätes überprüfen. Eine nicht eben ausgerichtete Position könnte Vibrationen hervorrufen
	Kontrollieren, ob das Gerät nicht in Kontakt mit anderen Geräten oder Teilen ist, die Resonanzen verursachen könnten
Im Kühlschrank könnten unangenehme Gerüche sein	Es könnten Lebensmittel mit besonderen starken Geruch (wie z.B. Käse und Melone), in nicht gut verschließte Behälter sein
	Die Innenfläche müssen sauber gemacht werden
Auf dem Gerät bildet sich Kondenswasser	Hohe Raumfeuchtigkeit
	Die Kühlschrankstüren sind nicht gut zugemacht worden

Sollte nach Durchführung der o.g. Überprüfungen der Defekt bestehen bleiben, ist sich an den Technischen Kundendienst zu wenden, wobei folgendes anzugeben ist:

- die Art des Defektes;
- die Modell und die Seriennummer des Gerätes, die dem Typenschild zu entnehmen sind, das sich unter der Bedienblende des Gerätes befindet.

MÜLLENTSORGUNG

Bei Ende des Lebenszyklus des Produktes, Apparat nicht in die Umwelt freisetzen. Die Türen müssen vor der Entsorgung des Gerätes demontiert werden.

Eine provisorische Lagerung des Mülls ist Hinblick auf eine Entsorgung mittels definitiver Behandlung und/oder Lagerung zulässig.

Trotzdem sind die im Land des Betreibers geltenden Gesetzgebungen des Umweltschutzes zu beachten.

VERFAHRENSWEISE HINSICHTLICH DER GROBEN DEMONTAGE DES GERÄTES

In verschiedenen Ländern gelten unterschiedliche Gesetzgebungen, daher sind die Vorschriften der Gesetzgebung und der Behörden des Landes zu beachten, in dem die Demolierung erfolgt.

Im allgemeinen ist der Kühlschrank an spezielle Sammel- und Zerlegungszentren abzugeben. Den Kühlschrank demontieren, indem die Bestandteile je nach ihrer chemischen Zusammensetzung zusammenzufassen sind, wobei darauf zu achten ist, daß sich in dem Kompressor Schmieröl und Kühlfüssigkeit befinden, die aufgefangen werden und wiederverwertbar sind, und daß es sich bei den Bestandteilen des Kühlschranks um Sondermüll handelt, der von den städtischen Behörden zu entsorgen ist.

Das Gerät ist vor der Entsorgung unbrauchbar zu machen, indem das Stromkabel und jegliche Schließvorrichtung entfernt werden, um zu vermeiden, daß jemand in seinem Inneren eingeschlossen werden kann.

DIE DEMONTIERARBEITEN SIND AUF JEDEN FALL VON QUALIFIZIERTEM FACHPERSONAL DURCHFÜHREN.

SICHERHEIT BEI DER ENTSORGUNG VON ELEKTRO- UND ELEKTRONIK-ALTGERÄTEN (WEEE-RICHTLINIE 2002/96/EG)

Umweltschädliche Stoffe dürfen nicht in die Umwelt gelangen. Die Entsorgung in Einklang mit den geltenden gesetzlichen Bestimmungen vornehmen.

Gemäß der WEEE-Richtlinie 2002/96/EG (Elektro- und Elektronik-Altgeräte) muss der Betreiber bei der endgültigen Außerbetriebnahme die Geräte bei den hierfür vorgesehenen Rücknahmestellen abgeben oder im Moment des Erwerbs neuer Geräte unzerlegt an den Verkäufer zurückgeben.

Alle Geräte, die in Einklang mit der WEEE-Richtlinie 2002/96/EG entsorgt werden müssen, müssen mit dem entsprechenden Symbol gekennzeichnet sein (12).

Die gesetzwidrige Beseitigung von Elektro- und Elektronik-Altgeräten zieht Sanktionen nach Maßgabe der gesetzlichen Bestimmungen in dem Mitgliedstaat nach sich, in dem die Zuwiderhandlung begangen wurde.

ELEKTRO- UND ELEKTRONIK-ALTGERÄTE KÖNNEN GEFÄHRLICHE STOFFE ENTHALTEN, DIE SCHÄDLICH FÜR DIE GESUNDHEIT DER PERSONEN UND FÜR DIE UMWELT SEIN KÖNNEN. DAHER MÜSSEN SIE UNBEDINGT VORSCHRIFTSMÄßIG ENTSORGT WERDEN.

TÜR INVERSION (82)

Die Kühlschränke mit einer Tür werden normalerweise mit rechter Öffnung geliefert.

Zur Montage des Türanschlags auf der linken Seite ist wie folgt vorzugehen:

Das Armaturenbrett auf die seitlichen Zylinderköpfe drehen, und die Festschraube "F" entfernen.

Die beiden Befestigungsschrauben des Bügels "A" und die Schraube zur Halterung des Scharniers "B" entfernen.

Tür abnehmen und Scharnier "B" sowie Bauteil "E" demontieren und anschließend umgekehrt montieren.

Unteren Bügel "D" demontieren und anschließend auf der gegenüberliegenden Seite an vorgesehener Stelle montieren.

Tür anlegen und dabei den Stift des Bügels "D" in die Bohrung im unteren Bauteil "E" einführen.

Bügel "A" auf der gegenüberliegenden Seite am Gehäuse befestigen und dabei die Schrauben bis zum Anschlag anziehen.

Vor Anziehen der Schrauben des Bügels das Scharniermaß kontrollieren; es soll ca. 12 mm betragen.

Lotrechte der Tür bezogen auf das Gehäuse überprüfen.

Mikro an der gegenseitigen Schaltbrettseite anwesend versetzen, indem die vorbereitenden Löcher benutzt werden.
Armaturenbrett wiederaufbauen.

ANMERKUNG: Die Handgriffe zur Demontage und erneuten Montage der Bügel sind bei geschlossener Tür vorzunehmen.

TECHNISCHES DATENBLATT FÜR KÜHLMITTEL

R404a: Bestandteile der Flüssigkeit

Trifluoräthan	(HFC 143a)	52%
Pentafluoräthan	(HFC 125)	44%
Tetrafluoräthan	(HFC 134a)	4%

GWP = 3750

ODP = 0

Gefahrenkennzeichnung

Bei längerem Einatmen kann eine Betäubungswirkung eintreten. Bei sehr langen Einatmungszeiten kann es zu Herzrhythmusstörungen und plötzlichem Tod kommen. Beim Versprühen oder Verspritzen des Produkts können Haut-oder Augenschaden durch Erfrierung auftreten.

Erste-Hilfe-Maßnahmen

• Einatmen:

verletzten aus der Gefahrenzone entfernen, zudecken und ruhigstellen. Falls erforderlich, mit Sauerstoff beatmen. Bei eingetretenem oder bei Anzeichen eines nahenden Atemstillstands ist der Verletzte künstlich zu beatmen. Bei Herzversagen ist eine äußerliche Herzmassage durchzuführen. Sofort Arzt rufen.

• Hautkontakt:

Die betroffene Hautstelle mit Wasser erwärmen. Die mit Kühlmittel in Berührung geratenen Kleidungsstücke ausziehen.

ACHTUNG: Bei Erfrierungen können die Kleidungsstücke an der Haut kleben.

Bei Hautkontakt sofort mit reichlich warmem Wasser abspülen. Bei Auftreten von Symptomen wie Hautreizungen oder Blasenbildung ist der Arzt zu rufen.

• Augenkontakt:

Auge sofort mit speziellen Augenbadiosungen oder frischem Wasser ausspülen. Dabei Augenlider aufspreizen und mindestens 10 Minuten spülen. Arzt rufen.

• Verschlucken:

kann das Brechen verursachen. Wenn der Verletzte bei Bewußtsein ist, Mund mit Wasser ausspülen und 200-300 ml Wasser trinken lassen. Sofort Arzt rufen.

• Weitere Behandlung:

Falls erforderlich, symptomatische Behandlung und Unterstützungstherapie vornehmen. Kein Adrenalin oder ähnliche Sympatikomimetika verabreichen, da Gefahr von Herzrhythmie mit möglichem Herzstillstand besteht.

Umweltschutzinformationen

Beständigkeit und Abbaubarkeit

• HFC 143a:

Baut sich langsam in der unteren Atmosphäre (Troposphäre) ab. Die Dauer in der Atmosphäre beträgt 65 Jahre.

• HFC 125:

Baut sich langsam in der unteren Atmosphäre (Troposphäre) ab. Die Dauer in der Atmosphäre beträgt 40 Jahre.

• HFC 134a:

Baut sich relativ schnell in der unteren Atmosphäre (Troposphäre) ab. Die Dauer in der Atmosphäre beträgt 15,6 Jahre.

• HFC 143a, 125, 134a:

Keine Auswirkung auf die photochemische Verschmutzung (fällt nicht unter flüchtige organische Stoffe – VOC – gemäß UNECE-Vereinbarung). Verursacht keine Schäden in der Ozonschicht.

Die in die Atmosphäre gelangenden Abfallprodukte verursachen keine Langzeitverseuchung der Gewässer.

DAS ELEKTROSCHEMA IST AUF DER LETZTEN SEITE DER BROSCHÜRE ABGEBILDET

POS	BESCHREIBUNG	POS	BESCHREIBUNG
1	KOMPRESSORGRUPPE	44	RELAY
2	KOMPRESSORLÜFTER	44A	RELAY PTC
3	HAUPTKLEMMLEISTE	44B	RELAY MAGNETISCHER MIKROSCHALTER
6	HUPTSCHALTER MIT KONTROLLAMPE	56	FILTRE
8	STECKER	69	ERDMASSE
9	EVAPORATORLÜFTER	70	SICHERHEITSKONTROLLEINRICHTUNG FÜR HOCHDRUCK
9A	EVAPORATORLÜFTER	75	ELEKTROVENTIL
9B	EVAPORATORLÜFTER	76	MAGNETISCHER MIKROSCHALTER
10	INNENBELEUCHTUNGLAMPE	85	VERBINDUNGSDOSE
10A	INNENBELEUCHTUNGLAMPE	86	KONDENSATORSONDE
12	ELEKTROVENTIL ENTFROSTUNG	90	DIGITALER THERMOREGLER
14	FEUCHTIGKEITREGLER MIT LEUCHE	91	WIDERSTAND PTC
15	MIKROSCHALTER FLÜGEL	96	ELEKTRONIKKARTE
15A	MIKROSCHALTER FLÜGEL	101	WIDERSTANDPUFFER
18	LEUCHE SICHERHEITSTHERMOSTAT	102	SICHERHEITSBIMETALLTHERMOSTAT
19	SICHERHEITSTHERMOSTAT	103	FEUCHTIGKEITSSONDE
20	WIDERSTAND ANTIKONDENS TÜR	104	NIVEAUREGLER
20A	WIDERSTAND ANTIKONDENS TÜR	105	NIVEAUSONDE
21	WIDERSTAND ENTFROSTUNG	106	SICHERHEITSTHERMOSTAT DAMPFERZEUGER
22	WIDERSTAND SCHÜSSELBODEN	107	RAUM-ELEKTROWIDERSTAND
25	TRANSFORMATOR	108	DAMPFERZEUGER-WIDERSTAND
28	SCHALTER INNERE BELEUCHTUNG	109	GÄRUNTERBRECHER-TAFELKARTE
29	ERREGERWIKLUNG LAMPEN TL	110	GÄRUNTERBRECHER-STEUERUNGSKARTE
30	STARTER	111	EXPANSIONKARTE-GÄRUNTERBRECHERRELAIS
31	LAMPE TL	112	ELEKTROVENTIL FEUCHTIGKEITSWASSER

INDEX

MACHINE DESCRIPTION	2
ACCESSORIES	2
IDENTIFICATION TAG	2
GENERAL NOTES BY THE DELIVERY	3
SAFETY PRESCRIPTION	3
HACCP REGULATIONS	4
TECHNICAL SPECIFICATIONS	4
INSTALLATION	4
CONTROL PANNELS	6
STARTING	7
LOADING THE PRODUCT	7
OPERATION <small>MANUAL CYCLE – AUTOMATIC CYCLE</small>	7
STOPPING	12
DEFROSTING	13
SETTING TIME	13
SETTING STANDARD TIME	13
LANGUAGE	14
PROGRAMMING	14
ALARMS	20
WORKING IRREGULARITIES	21
DAILY CLEANING	21
FOOD STAINS AND HARDENED RESIDUES	22
PERIODIC CLEANING AND MAINTENANCE	22
USAGE INTERRUPTIONS	23
USEFULL ADVICES FOR THE CARE OF THE STAINLESS STEEL	23
MALFUNCTIONING	23
WASTE DISPOSAL AND DEMOLITION	24
INVERTING THE DOOR	24
REFRIGERANT MATERIAL SAFETY DATA SHEET	25

MACHINE DESCRIPTION

This appliance has been designed for refrigerating, heating and storing foodstuffs. Any other use is to be considered improper.

ATTENTION: the appliances are not suitable for installation outdoors or in environments subject to the action of the elements.

The manufacturer cannot be held liable for improper use of its products.

Appliances with steel doors are available.

Appliances are equipped with "REGULAR TEMPERATURE" and "LOW TEMPERATURE" refrigerating systems to allow food storing at different temperatures. (1)

Appliances are equipped with stainless fin evaporator, hermetic compressor, copper-aluminium condenser, humidification kit, inner resistance, humidity probe with control panel. (2)

Appliances are equipped with a control panel allowing different types of settings for the different types of systems (POSITIVE TEMPERATURE, LOW TEMPERATURE). (3)

The compressors are installed in the upper part of the cabinets for a better airing and heat dissipation. (4)

Located on the rear outer side of the appliance is a tray equipped with an automatic device for condensate evaporation. (5)

None of the refrigerated cabinets have a condensation collector basin.

According to the model, two different lighting systems are available. Inner lamps are protected to avoid accidental contact with foodstuffs and prevent them from breaking. (8)

The doors are provided with key to ensure a safe closing. (9)

The areas that come into contact with the product are in steel or covered in non-toxic plastic material.(10)

An HFC refrigerant fluid, approved by current legislation, is used in the refrigerating units.

ACCESSORIES

See picture 7.

IDENTIFICATION TAG

For any communication with the manufacturer, always mention the MODEL and the SERIAL NUMBER of the appliance which are reported on the technical feature plate. (11)

Appliance rating plate containing the following ratings (12)

- | | |
|--------------------------------|---|
| 1) MODEL | F) FAUSE CURRENT |
| 2) SUPPLIER'S NAME AND ADDRESS | G) REFRIGERATING SYSTEM TEMPERATURE GRADE |
| 3) CE MARK | H) REFRIGERATING GAS QUANTITY |
| 4) YEAR OF MAKE | L) REFRIGERATING GAS |
| 5) SERIAL NO | M) MAX. WATER PRESSURE |
| 6) ELECTRIC INSULATING GRADE | N) WATER TEMPERATURE |
| 7) ELECTRIC PROTECTION GRADE | O) WATER CONSUMPTION |
| A) POWER SUPPLY VOLTAGE | P) MIN. WATER PRESSURE |
| B) ELECTRIC CURRENT RATE | R) WEEE SYMBOL |
| C) POWER SUPPLY FREQUENCY | W) HEATING SECTION POWER |
| D) RATED POWER | |
| E) TOTAL LAMP POWER | |

GENERAL NOTES BY THE DELIVERY

At the delivery inspect that the packing is not injured and that it has not been damaged during the transport. (13)

After having unpacked the appliance verify that all the parts are present and that the characteristics and the condition correspond to the order specifications.

Otherwise contact immediately the retailer. (14)

We congratulate you on your choice and we hope that you can use our refrigerating cabinets to their utmost, by following the necessary instructions and precautions contained in this manual. (15)

But, remember that any reproduction of this manual is forbidden and that due to a constant pursuit of innovation and technological quality, the features hereby presented could change without notice.

SAFETY PRESCRIPTIONS

WARNING: before any maintenance or cleaning operation the machine must be insulated from the current.

Turn OFF the switch located on the panel. (16a)

switch the general cut-out in OFF position. (16)

remove the plug. (17)

WARNING: do not use current taps or plugs not provided with grounding. (18)

The socket must be provided with GROUNDING. (19)

WARNING: do not use adapters or patch cords for the connection to the electric line. (20)

WARNING: wait the time necessary to reach the setted temperature before to introduce the food to preserve. (21)

Always cover the food with the special film before to put it into the appliance. (22)

WARNING: do not introduce hot foods or drinks into the appliance. (23)

WARNING: Store the food to be preserved so as not to brim over the grids. Thus air flow will not be hampered. Do not obstruct fan intake area. (24)

WARNING: do not do the cleaning around the appliance when the door is open.

Do not wash the appliance by spraying high-pressure water on the machine. (26)

WARNING: do not use substances with base of chlorine (chlorine water, muriatic acid, etc.) or however toxic for the cleaning or near the appliances. (27)

WARNING: do not cover the upper side of the appliance or the air inlets when the machine is working or live. (28)

WARNING: do not place objects on the appliance bottom. Use the grids provided (29).

The maximum weight on the grids is 48 kg.

The cleaning and mantainance of the refrigerating engine and the compressor area needs the intervention of a skilled technician, therefore it cannot be done by other persons. (30)

For a maintenance intervention or in case of anomaly disconnect completely the machine; ask for the TECHNICAL SERVICE to an entitled center and the use of original spare parts. (31)

The unfulfilment of this above can endanger the safety state of the appliances.

HACCP REGULATIONS

WARNING: Easily perishable foodstuffs must be taken out of the refrigerated ambient as late as possible in order to be exposed to room temperature only the necessary time.

WARNING: Do not refreeze foodstuffs previously defrosted.

WARNING: Number the equipment and check twice a day the temperature taken by recording the figures on a proper sheet to be kept for 24 months.

WARNING: Any interruption of current to the appliances can be carried out by checking the downtime with an electric clock in order to eliminate the foodstuffs that could perish.

Maximum temperatures admitted for goods

Foodstuff	Normal storage temperature (°C)	Maximum temperature of carriage (°C)
Fresh pasteurized milk	0÷+4	9
Fresh cream	0÷+4	9
Yoghurt, ricotta, fresh cheese	0÷+2	9
Frozen fish	0÷+2	0÷+4

TECHNICAL SPECIFICATIONS

Last page on the handbook: technical specifications. (32)

INSTALLATION

The appliances are always sent packed and on pallet. (33)

On receiving and after having unpacked in case of damages or missing pieces act as described in the chapter "GENERAL NOTES BY THE DELIVERY".

All setting up and starting operations are to be carried out by skilled staff. (30)

Remove the packing box with care so as not to dent the equipment surface. (34)

WARNING: package parts (plastic bags, polystyrene foam, nails and the like) are dangerous for children and must not be left within their reach.

Using a fork truck lift the appliance and take it to his place paying attention not to unbalance the load. (35)

WARNING: never place the appliance horizontally during transport; this may cause serious structure and system damage. (36)

WARNING: whether for the positioning or for further displacements do not push or pull the refrigerator, to avoid to upset it or to damage some parts. (37)

WARNING: do not install the appliance near heat sources or in rooms with high temperature, this would cause a lower efficiency with higher wear of it. (38)

WARNING: Distance from the ceiling should be 50 cm at least. Appliances can be placed next to each other, but in case of condensation space them out 20 cm at least.

Remove protective film from product.

This may cause unpleasant static electricity discharge which, however, is not dangerous.

The inconvenience is reduced or prevented by continuously holding the appliance with one hand or grounding the package. (39)

After having positioned the machine remove the pallet using a chisel and a hammer, paying attention not to damage the feet under the blocks or the appliance. (40)

Draw the stiffening block from the port under the machine. (41)

The drain trap located under the appliance should be connected directly to the drainage system. (41a)

The water supply tube (attachment 3/4") located on the upper side of the appliance should be connected to the water mains by means of an intercepting valve, a cartridge filter and a no-return valve. (41b)

The water supply temperature should range between 5°C and 40°C.

There should be enough water pressure to guarantee best operating conditions (>1bar).

If the water that is being used is full of impurities, we recommend using specific cleaning filters or depurators.

Now it is possible to regulate the feet. (42)

Put the appliance at level by keeping it slightly inclined at its back in order to allow the optimum self-closing door. (43)

Clean with tepid water and neutral soap (as written in the chapter "CLEANING") and mount the fittings placed into the appliance.

The appliance is supplied with an electric plug, SHUKO type. Make sure it complies with EN60320 and national regulations. Otherwise, replace with a complying one. (44)

WARNING: The operation must be carried out by a skilled technician. (30)

Check that the line voltage corresponds to the one referred on the appliance's identification tag. (45)

Then insert the plug into the current tap. (46)







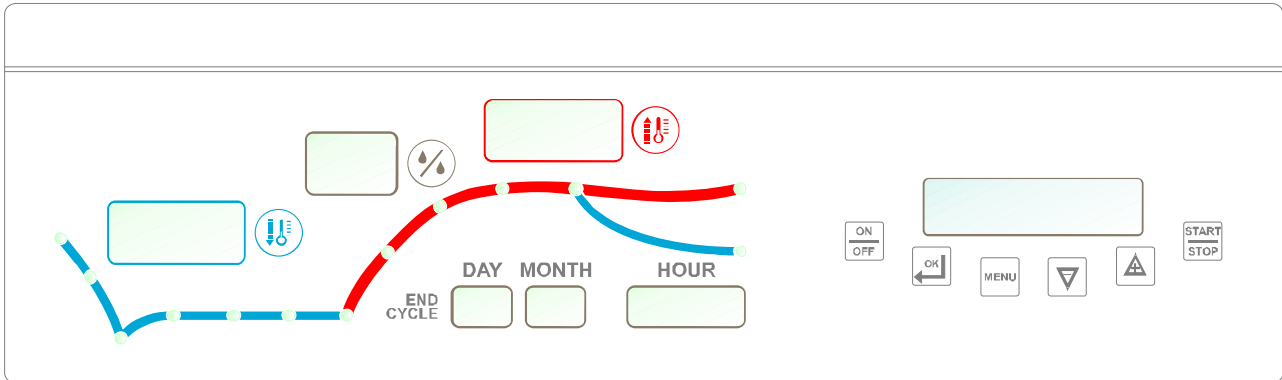

Now the installation has come to end.

The appliance must moreover be included in a unipotential system whose performance and conditions must comply with current regulations.

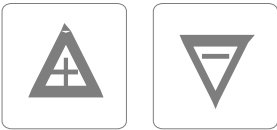
Connections must be carried out by means of a screw marked "Unipotential" and located in the compressor section. (47)

CONTROL PANNELS



	<p><u>ON/OFF key</u> Pressing the key for 3 seconds, the controller turns off and the display shows OFF _</p> <p>Successively, press the button and the controller will light back up and be displayed 02/01/2009 Tue 17:35</p>
	<p><u>Enter key</u> Allows access to a menu or parameter selection.</p> <p><i>Press the button during the cycle to see the date and time.</i></p>
	<p><u>Menu key</u> Allows access to the main menu or return to the previous menu.</p>
	<p><u>Up e Down keys</u> Allow to scroll the different menus or change parameter values.</p>
	<p><u>Start/Stop key</u> Allows a cycle to be started/stopped.</p> <p><i>With idle equipment, press the button for 3 sec and the programme relative to the day of the week will be activated automatically.</i></p>
	<p>Displays the room temperature during the cooling, storing, or proving-stop phase.</p>
	<p>Displays the room humidity percentage. <i>Switched on during phases in which humidity control is provided.</i></p>
	<p>Displays the room temperature during the heating, climatization, proving, retarding or restarting phase</p>
	<p>Indicates date and time. <i>Displays current day, month and time with card in standby or manual cycle in progress.</i> <i>Displays end cycle day, month and time if the automatic cycle is in progress.</i></p>

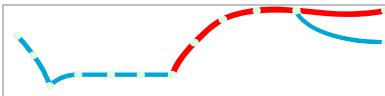

Displays the progress of the selected cycle.
LED corresponding to already concluded phases remain switched on while following phases are run.

The card allows to set **automatic** cycles or start **manual** cycles

Manual cycle: setting the 3 phases:
COOLING, HEATING AND CLIMATIZATION

Automatic cycles: (7 set and/or changeable cycles) featuring the following phases:
PROVING-STOP, STORING, RESTARTING, PROVING AND RETARDING

STARTING

To start operation, follow this procedure:

- Insert the plug into the current tap; (50)
- position the line switch on ON; (51)
- press the key ;

The display shows

02/01/2009
Tue 17:35

LOADING THE PRODUCT







- Now and not before it is possible to put the food to conserve into the appliance.
- Place the products into the cell uniformly to allow a good internal air circulation across the cell.
- Avoid obstructing the ventilation areas inside the appliance. Stickers are to be found inside the cell indicating the loading limit of the shelves.
- Only leave the door open for the strict amount of time necessary to introduce or remove food.
- It is recommended that the keys be kept out of reach of children.





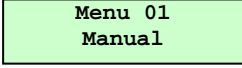

OPERATION

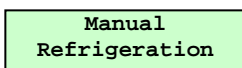
MANUAL CYCLE

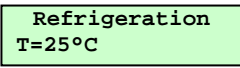





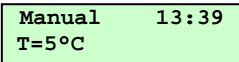





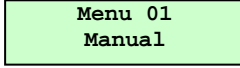

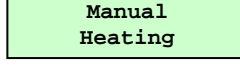

The manual cycle is made up of 3 independent phases. Switch from one phase to another *is not automatic*.

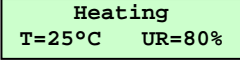
COOLING PHASE

	Press <u>menu</u> to select the desired menu
 	Use the keys <u>up</u> and <u>down</u> to display 
	Press <u>enter</u> to confirm your choice
 	Use the keys <u>up</u> and <u>down</u> to display 





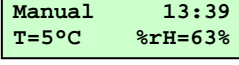









	Press <u>enter</u> to confirm your choice. The display shows 
	Press the <u>enter</u> button to enter into SetPoint modification mode. Temperature SetPoint value flashes, use the  and  buttons to modify the value
	Press the <u>enter</u> button to confirm the new value entered
	Press the <u>start/stop</u> button to immediately activate the selected phase. The display shows 

HEATING PHASE

	Press <u>menu</u> to select the desired menu
 	Use the keys <u>up</u> and <u>down</u> to display 
	Press <u>enter</u> to confirm your choice
 	Use the keys <u>up</u> and <u>down</u> to display 
	Press <u>enter</u> to confirm your choice. The display shows 
	Press the <u>enter</u> button to enter into SetPoint modification mode. Temperature SetPoint value flashes, use the  and  buttons to modify the value
	Press the <u>enter</u> button to confirm the new value entered. SetPoint Humidity value flashes, use the  and  buttons to modify the value
	Press the <u>enter</u> button to confirm the new value entered
	Press the <u>start/stop</u> button to immediately activate the selected phase. The display shows 

CLIMATIZATION PHASE

	Press <u>menu</u> to select the desired menu
---	--

 	Use the keys <u>up</u> and <u>down</u> to display	Menu 01 Manual
	Press <u>enter</u> to confirm your choice	
 	Use the keys <u>up</u> and <u>down</u> to display	Manual Air Con
	Press <u>enter</u> to confirm your choice. The display shows	Air Con T=25°C UR=80%
	Press the <u>enter</u> button to enter into SetPoint modification mode. Temperature SetPoint value flashes, use the  and  buttons to modify the value	
	Press the <u>enter</u> button to confirm the new value entered. SetPoint Humidity value flashes, use the  and  buttons to modify the value	
	Press the <u>enter</u> button to confirm the new value entered	
	Press the <u>start/stop</u> button to immediately activate the selected phase. The display shows	Manual 13:39 T=5°C %rH=63%

AUTOMATIC CYCLE

The electronic card has 7 automatic cycles memorized as follows

APPLIANCES -5°C / +30°C

CYCLE		P1	P2	P3	P4	P5	P6	P7
		Monday	Tuesday	Wednesday	Thursday	Friday	Saturday	Sunday
STOP	Duration	02:00	02:00	02:00	02:00	02:00	02:00	02:00
	Temperature	-5°C	-5°C	-5°C	-5°C	-5°C	-5°C	-5°C
STORAGE	Temperature	-1°C	-1°C	-1°C	-1°C	-1°C	-1°C	-1°C
RESTARTING	Duration	02:00	02:00	02:00	02:00	02:00	02:00	02:00
	Temperature	20°C	20°C	20°C	20°C	20°C	20°C	20°C
	Humidity	70%	70%	70%	70%	70%	70%	70%
PROVER	Duration	02:00	02:00	02:00	02:00	02:00	02:00	02:00
	Temperature	28°C	28°C	28°C	28°C	28°C	28°C	28°C
	Humidity	80%	80%	80%	80%	80%	80%	80%
END OF PROGRAMME	Hour	01:00	01:00	01:00	01:00	01:00	01:00	01:00
STOP	Temperature	6°C	6°C	6°C	6°C	6°C	6°C	6°C
	Humidity	80%	80%	80%	80%	80%	80%	80%

APPLIANCES -18°C / +30°C

CYCLE		P1	P2	P3	P4	P5	P6	P7
		Monday	Tuesday	Wednesday	Thursday	Friday	Saturday	Sunday
STOP	Duration	02:00	02:00	02:00	02:00	02:00	02:00	02:00
	Temperature	-20°C	-20°C	-20°C	-20°C	-20°C	-20°C	-20°C
STORAGE	Temperature	-1°C	-1°C	-1°C	-1°C	-1°C	-1°C	-1°C
RESTARTING	Duration	02:00	02:00	02:00	02:00	02:00	02:00	02:00
	Temperature	20°C	20°C	20°C	20°C	20°C	20°C	20°C
	Humidity	70%	70%	70%	70%	70%	70%	70%

PROVER	<i>Duration</i>	02:00	02:00	02:00	02:00	02:00	02:00	02:00
	<i>Temperature</i>	28°C	28°C	28°C	28°C	28°C	28°C	28°C
	<i>Humidity</i>	80%	80%	80%	80%	80%	80%	80%
END OF PROGRAMME	<i>Hour</i>	01:00	01:00	01:00	01:00	01:00	01:00	01:00
STOP	<i>Temperature</i>	6°C	6°C	6°C	6°C	6°C	6°C	6°C
	<i>Humidity</i>	80%	80%	80%	80%	80%	80%	80%









APPLIANCES -2°C / +30°C

CYCLE		P1	P2	P3	P4	P5	P6	P7
		<i>Monday</i>	<i>Tuesday</i>	<i>Wednesday</i>	<i>Thursday</i>	<i>Friday</i>	<i>Saturday</i>	<i>Sunday</i>
STOP	<i>Duration</i>	02:00	02:00	02:00	02:00	02:00	02:00	02:00
	<i>Temperature</i>	-2°C	-2°C	-2°C	-2°C	-2°C	-2°C	-2°C
STORAGE	<i>Temperature</i>	+2°C	+2°C	+2°C	+2°C	+2°C	+2°C	+2°C
RESTARTING	<i>Duration</i>	02:00	02:00	02:00	02:00	02:00	02:00	02:00
	<i>Temperature</i>	20°C	20°C	20°C	20°C	20°C	20°C	20°C
	<i>Humidity</i>	70%	70%	70%	70%	70%	70%	70%
PROVER	<i>Duration</i>	02:00	02:00	02:00	02:00	02:00	02:00	02:00
	<i>Temperature</i>	28°C	28°C	28°C	28°C	28°C	28°C	28°C
	<i>Humidity</i>	80%	80%	80%	80%	80%	80%	80%
END OF PROGRAMME	<i>Hour</i>	01:00	01:00	01:00	01:00	01:00	01:00	01:00
STOP	<i>Temperature</i>	6°C	6°C	6°C	6°C	6°C	6°C	6°C
	<i>Humidity</i>	80%	80%	80%	80%	80%	80%	80%

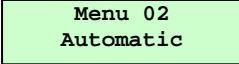
*Note: Max. dough temperature 27°C – flour vxx 320 – increase 0,01 yeast – increase 0,01 salt for savoury products or sugar for sweet products

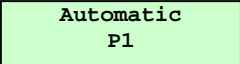
Each automatic cycle is made up of 5 phases.

The cycle starts with the PROVING-STOP phase and then **automatically** switches to the following phases, according to the duration of each single phase, the day and time previously set for the end of cycle.

	Press <u>menu</u> to select the desired menu
	Use the keys <u>up</u> and <u>down</u> to display 
	Press <u>enter</u> to gain access to the memorized programmes selection (P01... P07). The display shows 
	Use the <u>up</u> and <u>down</u> buttons to select the desired programme
	Press <u>enter</u> . The display shows 













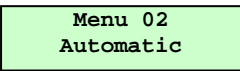

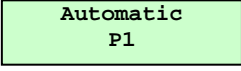









If end-of-cycle data indicated is the data desired, press the  button to confirm and start up cycle.

Otherwise, press  to modify end-of-cycle data.

AUTOMATIC CYCLE MODIFICATION



To change the pre-set cycles, observe the following instructions

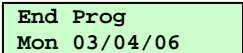

	Press <u>menu</u> to select the desired menu
---	--

 	Use the keys <u>up</u> and <u>down</u> to display 
	Press <u>enter</u> to gain access to the memorized programmes selection (P01... P07). The display shows 
 	Use the <u>up</u> and <u>down</u> buttons to select the desired programme
	Press the <u>enter</u> button to enter into the selected programme setting mode
	Use the <u>down</u> button to pass from one phase to another and the cycle phase with current setpoint values will be shown on the display
	Press the <u>enter</u> button to modify. The <i>Hours</i> value will begin to flash. Use the  and  buttons to modify the value.
	Press the <u>enter</u> buttons to confirm the new entered value. Data will stop flashing. The <i>Minutes</i> value will begin to flash. Use the  and  buttons to modify the value.
	Press the <u>enter</u> buttons to confirm the new entered value. Data will stop flashing. The <i>Temperature SetPoint</i> value will begin to flash. Use the  and  buttons to modify the value.
	Press the <u>enter</u> buttons to confirm the new entered value. Data will stop flashing. The <i>Humidity SetPoint</i> value will begin to flash (if present). Use the  and  buttons to modify the value.
	Press the <u>enter</u> buttons to confirm the new entered value. Data will stop flashing. Use the  and  buttons to select the other phases and modify their Setpoint.

Pressing the  button permits the user to memorize the programme and return to the previous menu.

Pressing the  button permits the user to start-up the programme and the display shows the end-of-cycle data.

If end-of-cycle data indicated is the data desired, press the  button to confirm and start up cycle. Otherwise, press  to modify end-of-cycle data.

The day flashes. Move data to the programme end with the  button. Press the  button to confirm new data entered and press the  button to start up cycle.

AUTOMATIC CYCLE RUNNING

During automatic cycle running, the display will:

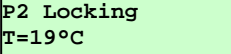

Indicate the programme number in progress, the phase in progress, current cell temperature and, if the phase also foresees humidity probe, it will show the percentage of humidity present.

Phase date and hour display

Press the  button to see the end date and time of the phase in progress.

Press the  button to see the end date and time of successive phases.

The display shows 

Where PH0 indicates that programme phase 0 is in progress, precisely the Stopping phase.
 Other phases are indicated with:
 PH 1 which indicates Storage
 PH 2 which indicates Restarting
 PH 3 which indicates Prover
 PH 4 which indicates Retarding

The display will show the following when the  button is pressed or a timeout of 5 seconds takes place.

INPUT/OUTPUT status display

Press the  button to see INPUT/OUTPUT status.

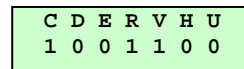

The display will show the following when the  button is pressed or a timeout of 20 seconds takes place.

Date and hour display

Press the  button to see the date and hour.

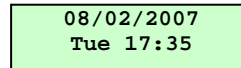







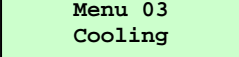

The display will show the following when the  button is pressed or a timeout of 5 seconds takes place.

Pressing the  button at any time stops cycle running. The cycle will however remain selected.

COOLING CYCLE

Start-up of a cooling cycle before selecting any cycle is recommended.

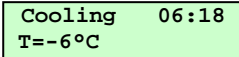
	Press <u>menu</u> to select the desired menu
	Use the keys <u>up</u> and <u>down</u> to display 
	Press the <u>enter</u> button to enter into SetPoint modification mode. Temperature SetPoint value flashes, use the  and  buttons to modify the value.
	Press the <u>enter</u> button to confirm the new value entered
	Press the <u>start/stop</u> button to immediately activate the cooling cycle The display shows 

Press the  button to return to SetPoint modification.

STOPPING





In any case, the appliance can be started by pressing the key  ;

The display shows 

ATTENTION: the key  DOES NOT disconnect the appliance from the power supply.

To disconnect the appliance from the power supply, remove the plug from the socket. (17)

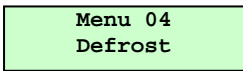

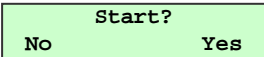





DEFROSTING

	Press <u>menu</u> to select the desired menu
	Use the keys <u>up</u> and <u>down</u> to display 
	Press <u>enter</u> to gain access to the defrost activation The display shows 

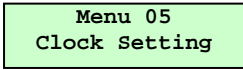

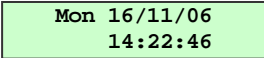





Press the  button to exit from the menu and defrosting will not be activated.

Press the  button to activate defrosting

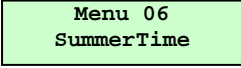

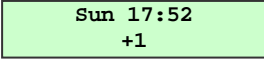





SETTING TIME

	Press <u>menu</u> to select the desired menu
	Use the keys <u>up</u> and <u>down</u> to display 
	Press <u>enter</u> to gain access to the clock setting mode. The display shows  Use the  and  buttons to modify the flashing digit
	Press <u>enter</u> to confirm and pass to the next value
	Press <u>menu</u> to exit of the selection

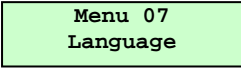
SETTING STANDARD TIME

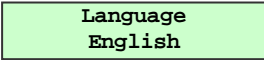
	Press <u>menu</u> to select the desired menu
 	Use the keys <u>up</u> and <u>down</u> to display 
	Press the <u>enter</u> button to enter into standard time setting mode. The display shows  Use the  and  buttons to modify the hour
	Press the <u>enter</u> button to confirm the new value entered
	Press <u>menu</u> to exit of the selection

LANGUAGE

	Press <u>menu</u> to select the desired menu
 	Use the keys <u>up</u> and <u>down</u> to display 
	Press the <u>enter</u> button to see the currently used language. The display shows 
 	Use the keys <u>up</u> and <u>down</u> to select the desired language
	Press <u>enter</u> to confirm your choice
	Press <u>menu</u> to exit of the selection

PARAMETERS

Changing parameters

	Press <u>menu</u> to select the desired menu
 	Use the keys <u>up</u> and <u>down</u> to display Menu 08 Set Up
	Press <u>enter</u> to confirm your choice. The display shows Set Up Password 0
 	Use the keys <u>up</u> and <u>down</u> to select the password “-19”
	Press <u>enter</u> to confirm your choice. The first sub-menu appears Set Up 01 Parameters
	Press <u>enter</u> to gain access to the parameter programming mode The first parameter is displayed P01=-5°C
 	Use the keys <u>up</u> e <u>down</u> to scroll all the controller parameters
	Press <u>enter</u> to confirm your choice
 	Use the keys <u>up</u> e <u>down</u> to select the new value of the parameter
	Press <u>enter</u> to confirm your choice
	Press <u>menu</u> to return to the main menu

Description of parameters

Nr.	Description	Default -2/+30°C	Default -5/+30°C	Default -18/+30°C	Min	Max	U.M.
General Configuration							
P1	Power on display selection 0 = none 1 = EVCO s.r.l.	1	1	1	0	1	---
P2	0 = Celsius 1 = Fahrenheit	0	0	0	0	1	---
P3	Room probe offset	0	-2	-2	-15	15	°C/°F
P4	Evaporator probe offset	0	0	0	-15	15	°C/°F
P5	Humidity probe lower limit	0	0	0	0	P6	%
P6	Humidity probe upper limit	100	100	100	P5	200	%
P7	Door contact polarità input 0 = NO 1 = NC	0	0	0	0	1	---



Nr.	Description	Default -2/+30°C	Default -5/+30°C	Default -18/+30°C	Min	Max	U.M.
P8	Thermostat polarità input BT 0 = NO 1 = NC	0	0	0	0	1	---
P9	Power Duration down to reset automatic programme	15	15	15	1	60	minutes
P10	Mode selection after power down for an automatic programme 0 = an automatic cycle restarts only if the power down is under P9 minutes 1 = an automatic cycle restarts always	1	1	1	1	1	---
P11	Durata Power down for manual programme reset	15	15	15	1	60	minutes
P12	Mode selection after power down for a manual programme 0 = a manual cycle restarts only if the power down is under P11 minutes 1 = a manual cycle restarts always	1	1	1	0	1	---
Setpoint							
P13	Min setpoint possible in cooling	-2	-5	-24	-30	P14	°C/°F
P14	Max setpoint possible in cooling	10	10	5	P13	90	°C/°F
P15	Cooling hysteresis	2	2	2	1	10	°C/°F
P16	Cooling dead zone for refrigeration, stop and storage	0	0	0	0	10	°C/°F
P17	Cooling dead zone for heating, restarting and prover	0	0	0	0	10	°C/°F
P18	Cooling dead zone for climatization and retarding	0	0	0	0	10	°C/°F
P19	Min setpoint possible in heating	5	5	5	0	P20	°C/°F
P20	Max setpoint possible in heating	30	30	30	P19	90	°C/°F
P21	Heating hysteresis	1	1	1	1	10	°C/°F
P22	Heating dead zone for heating, restarting and prover	1	1	1	0	10	°C/°F
P23	Heating dead zone for per climatization and retarding	1	1	1	0	10	°C/°F
P24	Number of steps for resistances adjustment in restarting	9	9	9	1	10	---
P25	Number of steps for resistances adjustment in proving	1	1	1	1	10	---
Compressor Times							
P26	Dealy between two compressor starts	3	3	3	0	60	minutes
P27	Dealy between compressor stop/start	2	2	2	0	60	minutes
P28	Compressor start delay from power on	1	1	1	0	255	minutes
P29	Compressor forced start-up duration to restarting, prover and retarding phases	0	0	0	0	60	minutes
Resistance Times							
P30	Minimum resistance activation time	0	0	0	0	255	seconds
Humidification and Dehumidification							
P31	Inferior cell temperature limit for humidification/dehumidification	5	5	5	0	90	°C/°F
P32	Humidity control mode 0 = with humidity probe 1 = time cycles according to the percentage previously set 2 = steps of 1 minute	0	0	0	0	2	---
P33	Pause if P32 = 2	10	10	10	0	60	minutes
P34	Humification cycle duration if P32 = 1	60	60	60	30	600	seconds
P35	Humidification max. time if P32 = 1	30	30	30	0	P34	seconds
P36	Enables humidification in prover and storage stop phases 0 = disabled 1 = enabled	0	0	0	0	1	---
P37	Humidification hysteresis	1	1	1	1	100	%
P38	Humidification dead zone	4	4	4	0	100	%
P39	Band of Proportional Regulation for Humidification	4	4	4	0	20	%
P40	Cycle time for Humidification Prop. Reg.	1	1	1	1	255	seconds/ minutes
P41	Base times for Cycle Time 0 = seconds 1 = minutes	1	1	1	0	1	---
P42	De-humidification hysteresis	1	1	1	1	100	%
P43	De-humidification dead zone	5	5	5	0	100	%
P44	Dehumidification Attempt Time with Solenoid Valve	1	1	1	1	255	seconds
Ventilation							
P45	Evaporator Fan Proportional Regulation Enable 0 = regulation ON/OFF 1 = proportional regulation	0	0	0	0	1	---
P46	Evaporator fans operation in proving-stop 0 = parallel operation 1 = continuous operation	1	1	1	0	1	---
P47	Evaporator fans operation in storing 0 = parallel operation 1 = continuous operation	1	1	1	0	1	---
P48	Evaporator fans operation in restarting 0 = parallel operation 1 = continuous operation	0	0	0	0	1	---









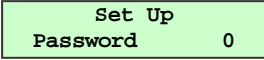

Nr.	Description	Default -2/+30°C	Default -5/+30°C	Default -18/+30°C	Min	Max	U.M.
P49	Evaporator fans operation in proving 0 = parallel operation 1 = continuous operation	0	0	0	0	1	---
P50	Evaporator fans operation in retarding 0 = parallel operation 1 = continuous operation	0	0	0	0	1	---
P51	Evaporator fans operation in cooling 0 = parallel operation 1 = continuous operation	1	1	1	0	1	---
P52	Evaporator fans operation in heating 0 = parallel operation 1 = continuous operation	0	0	0	0	1	---
P53	Fans operation in climatization 0 = parallel operation 1 = continuous operation	0	0	0	0	1	---
P54	Evaporator fans de-activation delay in parallel operation	1	1	1	0	255	minutes
P55	Evaporator fans parallel operating time	1	1	1	0	255	minutes
P56	Evaporator fans pause in parallel operation	1	1	1	0	255	minutes
P57	Minimum Evaporator Fan Speed	0	0	0	0	P58	%
P58	Maximum Evaporator Fan Speed	100	100	100	P57	100	%
P59	Minimum Evaporator Fan Speed during dehumidification	20	20	20	P57	P58	%
Defrosting							
P60	Evaporator Temperature for defrosting end	8	8	8	-40	99	°C
P61	Interval between two defrost cycles 0 = defrost is not repeated	8	8	6	0	10	ore
P62	Defrost max. duration	10	10	30	1	120	minutes
P63	Dripping time	2	2	3	0	30	minutes
P64	Fans state in defrost	0	0	0	0	1	---
P65	Fan stop duration after dripping	2	2	2	0	15	minutes
Cooling							
P66	Minimum Setpoint for Cooling	-2	-5	-5	-30	P67	°C
P67	Maximum Setpoint for Cooling	10	10	10	P66	30	°C
P68	Preset Cooling	-2	-5	-5	P66	P67	°C
Programme Setting and Modifications							
P69	Programme Setting Enable	1	1	1	0	1	---
P70	Programme Modification Enable	1	1	1	0	1	---
P71	K3 management: 0=Solenoid Valve; 1= Light; 2 = Dehumidification	1	1	1	0	2	---
P72	Management of Compressor with Door Open: 0 = no effect; 1= compressor off	0	0	0	0	1	---
P73	Defrosting type: 0 = Resistance; 1 = Hot Gas	0	0	0	0	1	---
P74	High evaporator temperature alarm	55	55	55	0	70	°C
P75	High evaporator temperature alarm enable: 0= not enabled; 1= enabled	1	1	1	0	1	---
P76	Dehumidification Enable 0= disabled 1= enabled in Restarting, Prover ,Retarding,Climatization,Heating 2=enabled also in Stop and Storage	0	0	0	0	2	---
P77	Resistance Time ON	3	3	3	1	255	seconds/ minutes
P78	Resistance Time OFF (0= resistance always on)	1	1	1	0	255	seconds/ minutes

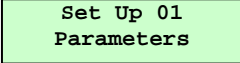
Note

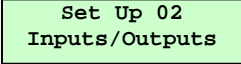

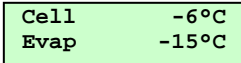

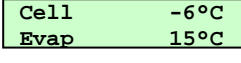
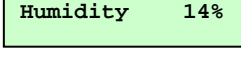
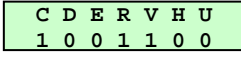
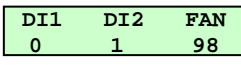



- Check compressor protection times as default is set to zero.
- P5 and P6 are used to define the humidity probe range. P5 should be set to humidity percentage equal to 4mA ; P6 should be set to humidity percentage equal to 20mA.
- Whenever changing P32, check the humidity setpoint of automatic and manual programmes.

INPUTS/OUTPUTS

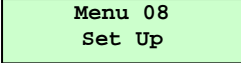
	Press <u>menu</u> to select the desired menu
 	Use the keys <u>up</u> and <u>down</u> to display Menu 08 Set Up

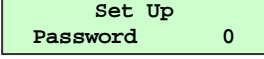
	<p>Press <u>enter</u> to confirm your choice.</p> <p>The display shows </p>																
	<p>Use the keys <u>up</u> and <u>down</u> to select the password “-19”</p>																
	<p>Press <u>enter</u> to confirm your choice.</p> <p>The first sub-menu appears </p>																
	<p>Use the keys <u>up</u> and <u>down</u> to display </p>																
	<p>Press <u>enter</u> to gain access to the mode for displaying inputs and outputs</p> <p>The display shows </p>																
	<p>Use the keys <u>up</u> and <u>down</u> to scroll the data to display</p> <div style="display: flex; justify-content: space-between;"> <div style="width: 45%;">  Room and Evaporator temperature values  Humidity probe value  Outputs state 1 = relay activated 0 = relay de-activated  Digital inputs state and evaporator fan speed </div> <div style="width: 45%;"> <table border="1" data-bbox="1046 902 1441 983"> <tr> <td>C</td> <td>Compressor</td> <td>V</td> <td>Fans</td> </tr> <tr> <td>D</td> <td>Defrost</td> <td>H</td> <td>Vapour gen.</td> </tr> <tr> <td>EV</td> <td>Dehumd Light</td> <td>U</td> <td>Humidifier</td> </tr> <tr> <td>R</td> <td>Resistances</td> <td></td> <td></td> </tr> </table> </div> </div>	C	Compressor	V	Fans	D	Defrost	H	Vapour gen.	EV	Dehumd Light	U	Humidifier	R	Resistances		
C	Compressor	V	Fans														
D	Defrost	H	Vapour gen.														
EV	Dehumd Light	U	Humidifier														
R	Resistances																
	<p>Press <u>menù</u> to return to the main menu</p>																

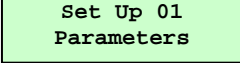
RIPRISTINO PARAMETRI DI DEFAULT

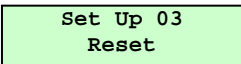
	<p>Press <u>menu</u> to select the desired menu</p>
	<p>Use the keys <u>up</u> and <u>down</u> to display </p>
	<p>Press <u>enter</u> to confirm your choice.</p> <p>The display shows </p>
	<p>Use the keys <u>up</u> and <u>down</u> to select the password “-19”</p>
	<p>Press <u>enter</u> to confirm your choice.</p> <p>The first sub-menu appears </p>
	<p>Use the keys <u>up</u> and <u>down</u> to display </p>



















	<p>Premere il tasto <u>enter</u> per accedere alla richiesta di cancellazione dei dati registrati in memoria.</p> <p>The display shows</p> <div data-bbox="660 235 903 302" style="border: 1px solid black; padding: 2px; text-align: center;"> Reset? No Yes </div>
---	--

Press the  button to exit from the menu without any resetting.

Press the  button to reset original default parameters.

Press  to return to the main menu.

REGOLAZIONE VELOCITA' VENTOLE

	<p>Press <u>menu</u> to select the desired menu</p>
 	<p>Use the keys <u>up</u> and <u>down</u> to display</p> <div data-bbox="960 707 1203 779" style="border: 1px solid black; padding: 2px; text-align: center;"> Menu 08 Set Up </div>
	<p>Press <u>enter</u> to confirm your choice.</p> <p>The display shows</p> <div data-bbox="683 857 948 925" style="border: 1px solid black; padding: 2px; text-align: center;"> Set Up Password 0 </div>
 	<p>Use the keys <u>up</u> and <u>down</u> to select the password “-19”</p>
	<p>Press <u>enter</u> to confirm your choice.</p> <p>The first sub-menu appears</p> <div data-bbox="903 1093 1145 1160" style="border: 1px solid black; padding: 2px; text-align: center;"> Set Up 01 Parametri </div>
 	<p>Use the keys <u>up</u> and <u>down</u> to display</p> <div data-bbox="948 1182 1190 1249" style="border: 1px solid black; padding: 2px; text-align: center;"> Set Up 04 Min Max Fan </div>
	<p>Press the <u>enter</u> button to enter into fan speed regulation mode.</p> <p>The display shows</p> <div data-bbox="660 1317 903 1384" style="border: 1px solid black; padding: 2px; text-align: center;"> Min Speed 0% </div>
	<p>Press the <u>enter</u> button to modify. The value will begin to flash.</p> <p>Use the  and  buttons to modify the value.</p>
	<p>Press <u>enter</u> to confirm your choice.</p> <p>The display shows</p> <div data-bbox="683 1541 927 1608" style="border: 1px solid black; padding: 2px; text-align: center;"> Max Speed 100% </div> <p>Use the  and  buttons to modify the value.</p>
	<p>Press <u>enter</u> to confirm your choice.</p>
	<p>Press <u>menù</u> to return to the main menu</p>

ALARMS AND SIGNALS

Acoustic signals and warning lights turn on in case of malfunctioning.

Cell probe

In case of a faulty probe, a Cell Probe Alarm will be set off. The buzzer will sound and an error message will flash on the display:

ALL CellSensor

Any cycles in progress will be interrupted all outputs are de-activated.
The buzzer can be turned off by pressing any button.
Once the alarm condition is over, the cycle will restart.

Safety thermostat

When the Thermostat alarm is detected on the card, the buzzer will sound and an alarm message will be displayed:

ALL Thermostat

Any cycles in progress will be interrupted all outputs are de-activated.
The buzzer can be turned off by pressing any button.

Once the alarm condition is over, press the  button to reset the card.

Evaporator probe

A faulty probe can cause an Evaporator Probe Alarm. The buzzer will sound and an alarm message will flash on the display:

ALL EvapSensor

Any cycles in progress will be interrupted all outputs are de-activated.
The buzzer can be turned off by pressing any button.
Once the alarm condition is over, the cycle will restart.

High Evaporator Temperature

When the Evaporator Probe reaches a value set in parameter *P74*, a high temperature alarm will be activated on the Evaporator. The buzzer will sound and an alarm message will flash on the display:

ALL High T Evap

Any cycles in progress will be interrupted all outputs are de-activated.
The buzzer can be turned off by pressing any button.

Once the alarm condition is over, press the  button to reset the card.

Humidity Probe

A faulty probe can cause a Humidity Probe Alarm. The buzzer will sound and an alarm message will flash on the display:

ALL HumSensor

Any cycles in progress will be interrupted all outputs are de-activated.
The buzzer can be turned off by pressing any button.
Once the alarm condition is over, the cycle will restart.

MicroDoor

Each time the door is opened, a flashing Door Open message will appear:

Door Open

Opening the door during a chilling cycle will stop the Fans, Resistances and Humidifier. The Compressor and Vapour Generator will remain on.

The buzzer will sound, but can be turned off by pressing any button and signalling will return automatically once the door is closed again.
The Light will switch on each time the Door is opened.

RTC Malfunction

Whenever RTC malfunction is detected, an RTC alarm is signalled. The buzzer will sound and an alarm message will flash on the display:

ALL RTC

Any cycles in progress will be interrupted all outputs are de-activated.
The buzzer can be turned off by pressing any button.
It is possible to enter the Time settings menu and set current RTC values after the card returns to standby.

EEPROM Alarm

Whenever corrupted data is memorised in Eeprom, an Eeprom alarm will be signalled. The buzzer will sound and an alarm message will flash on the display:

ALL EEprom

Any cycles in progress will be interrupted all outputs are de-activated.
The buzzer can be turned off by pressing any button.

To reset card, press the  button. After resetting, the card will return to standby.

NOTE: after an Eeprom alarm, all parameters will be reset to default values.

WORKING IRREGULARITIES

In case of working irregularities, before to call the technical service in zone verify that:

the main switch 1 is lighting and the current is present;(63)
the regulated temperature is the wished one;(65)
the doors are perfectly closed;
the machine is not near heat sources;(38)
the condenser is clean and the fan works regularly;
there is not excessive frost on the evaporating battery.

In case of negative result, contact the nearest service centre indicating the model and the serial number shown on the rating placed on the appliance instrument panel. (11)

DAILY CLEANING

To guarantee a perfect hygiene and conservation of the refrigerated cabinet (66) it is recommended to carry out often and/or daily the cleaning operations as indicated hereunder:

Carefully wash the external parts only through the satin finish, wiping with a squeezed sponge previously soaked in mild detergent.

The detergents must not contain chlorine and must not be abrasive. (67)

The kind of detergents recommended are the ones indicated hereunder:

Composite action disinfecting detergent; (containing non-ionic surfactants, benzalkonium chloride, chelating agents and pH buffer)

Laboratory, neutral detergent for hand washing; (containing anionic and non-ionic surfactants)

Food environments degreasant; (containing anionic surfactants and EDTA)

Before using the detergents, dilute them, if needed, following the instructions on the label.

Leave the detergents act for at least 5 minutes.

Rinse carefully the fridge walls with a sponge drenched in running water. (69)
Dry carefully using a clean sponge.

WARNING: absolutely do not use utensils or materials which could cause cuts and consequently rust formations. (68)

Remove any leftovers or food marks from the inside of the machine (see next paragraph)

FOOD STAINS AND HARDENED RESIDUES

In case there are food or waste stains in the fridge, wash the surfaces with water and clean them off before they might harden.

If the wastes have already hardened, please follow the instructions hereunder:

Use a soft sponge drenched with lukewarm water and neutral detergent (you can use the detergents for the daily cleaning operations, at the highest concentration estimated by the label). (72)

Dampen the hardened waste so as to maintain it damp for at least 30 minutes passing on it every five minutes the sponge drenched with water and detergents on the hardened dirty area.
At the end of this soaking operation remove the waste with the sponge drenched with water and neutral detergents.

If needed, use a wooden spatula or a fine stainless-steel sponge, taking care of not damaging the fridge surface. (70)

At the end of this process it is recommended a daily cleaning operation cycle of all the internal surfaces of the fridge.

When the cleaning operations are over, rinse carefully with a sponge drenched with running water.

Dry carefully using a clean sponge.

The space around and under the appliance must also be cleaned and held in perfect hygiene.
Clean using water and neutral soap or detergent. (71)

Protect the sheet metal parts with silicon wax.

PERIODIC CLEANING AND MAINTENANCE

For regular performance of the appliance, periodic cleaning and maintenance operations are recommended.

Before to begin with the operations proceed as following:

set the general cut-out in OFF position. (16)

remove the plug from the socket and wait till the complete defrosting of the appliance. (17)

After removing all protections, carefully clean the condenser of the refrigerating unit with either a vacuum cleaner or a non-metallic brush. (73)

WARNING: The cleaning and maintenance of the refrigerating engine and the compressor area needs the intervention of a skilled technician, therefore it cannot be done by other persons. (30)

Clean the inner/outer surfaces of the machine as suggested in the "daily cleaning" paragraph.
The appliances with positive temperature "NORMAL TEMPERATURE" are provided with a drain hole in the bottom.

Verify that the hole is not obstructed and eventually clean it. (75)

After opening the vapour generator kit cover, remove the vapour tube and decalcify using running water. Disassemble the boiler from the kit and decalcify with running water. Reassemble. (76a)
The cleaning and maintenance operations have now come to end.

USAGE INTERRUPTIONS

In case of longer inactivity of the appliance and for maintaining it in the best state act as following:

- set the general cut-out in OFF position. (16)
- remove the plug from the socket. (17)
- empty the appliance and clean it as described In the chapter "CLEANING". (76)
- drain the water from the vapour generator boiler after removing the clamp and tube. (76a)
- let the doors open to avoid the forming of bad smell. (77)
- cover compressor set with a nylon sheet to protect it from dust. (78)

USEFULL ADVICES FOR THE CARE OF THE STAINLESS STEEL

The appliances are built with STAINLESS STEEL AISI 304. (79)
For the cleaning and maintenance of the parts of stainless steel follow the advices written below, bearing in mind that the first and fundamental rule is to guarantee the non toxicity and best hygiene of the dealed products.

The stainless steel has a thin oxide coat that prevents rust formation.
But there are substances or detergents that can destroy this coat and give origin to corrosions.
Before using any detergent product ask always your dealer about which neutral detergent is the most qualified and does not cause corrosions on the steel. (73)

In case of scratches on the surfaces it is necessary to smooth them using thin STAINLESS STEEL wool or an abrasive sponge in synthetic fibrous material, wiping in the direction of the satin. (80)

WARNING: for the cleaning of the STAINLESS STEEL never use iron wool and never let them rest on the surfaces because little iron deposits could remain on the surfaces and cause rust formations by contamination and endanger the hygiene. (81)

MALFUNCTIONING

Malfunctioning during operation is often due to banal causes , which may nearly all be resolved without the help of a specialised technician. Consequently, before getting in touch with a service centre, check the following:

PROBLEM	POSSIBLE CAUSES
The appliance does not start	Check that the plug is properly inserted into the socket.
	Check that there is voltage at the socket
The internal temperature is too high	Check the electronic card adjustment
	Check for a heat source in the vicinity
	Check that the door closes properly
The appliance is excessively noisy	Check that the appliance is standing level. A lopsided appliance could set off vibrations
	Check that the appliance is not touching other appliances or parts which could resonate
There are unpleasant smells inside the appliance	There are foodstuffs with a particularly strong smell (for example cheese and melon), placed in non-sealed containers
	Internal surfaces must be cleaned
Some condensation is produced on the appliance	Room humidity is very high
	Doors are not well-closed

Upon completion of the above checks, if the fault persists, contact an authorised service centre. Always indicate:

- the nature of the fault

- the model and the serial number that can be found on the technical feature plate, placed under the appliance instrument panel.

WASTE DISPOSAL AND DEMOLITION

WASTE STORAGE

At the end of the product life, avoid release to the environment. The doors should be removed before disposal.

Temporary storage of special waste is permitted while waiting for disposal by treatment and/or final collection. Dispose of special waste in accordance with the laws in force with regard to protection of the environment in the country of the user.

PROCEDURE FOR ROUGH DISMANTLING THE APPLIANCE

All countries have different legislation; provision laid down by the laws and the authorised bodies of the countries where the demolition takes place are therefore to be observed.

A general rule is to deliver the appliance to specialised collection and demolition centres. Dismantle the appliance grouping together the components according to their chemical nature. The compressor contains lubricating oil and refrigerant, which may be recycled. The appliance components are considered special waste, which can be assimilated with domestic waste.

Make the appliance totally unusable by removing the power cable and any door locking mechanisms in order to avoid the risk of anyone being trapped inside.

DISMANTLING OPERATIONS SHOULD BE CARRIED OUT BY QUALIFIED PERSONNEL.

THE SAFE DISPOSAL OF WASTE FROM ELECTRICAL AND ELECTRONIC EQUIPMENT (WEEE DIRECTIVE 2002/96/EC)

Do not dump pollutant material in the environment. Dispose of it in compliance with the relevant laws.

Under the WEEE (Waste Electrical and Electronic Equipment) Directive 2002/96/EC, when scrapping equipment the user must dispose of it at the specific authorised disposal centres, or reassign it, still installed, to the original seller on purchase of new equipment.

All equipment which must be disposed of in accordance with the WEEE Directive 2002/96/EC is marked with a special symbol (12).

The improper disposal of Waste Electrical and Electronic Equipment is liable to punishment under the relevant laws in the countries where the offence is committed.

WASTE ELECTRICAL AND ELECTRONIC EQUIPMENT MAY CONTAIN HAZARDOUS SUBSTANCES WITH POTENTIAL HARMFUL EFFECTS ON THE ENVIRONMENT AND HUMAN HEALTH. YOU ARE URGED TO DISPOSE OF THEM PROPERLY.

INVERTING THE DOOR(82)

Appliance cabinets are normally supplied with opening to the right.

To invert the door (hinge on the left side) follow this procedure:

- Rotate the instrument panel on the side heads by removing the "F" screw.
- Remove the two fixing screws of the bracket "A" and the holding screw of the hinge "B".
- Extract the door, remove the hinge "B" and the component "E" and invert their position.
- Remove the lower bracket "D" and install it in its housing on the opposite side.
- Place the door by introducing the hole of the lower component "E" into the pin of the bracket "D".
- Fix the bracket "A" to the structure on the opposite side by tightening the fixing screws.
- Before tightening the bracket screws, check the hinge height (12 mm approx.) and the door perpendicular position with respect to the structure.
- Move the micro located on the control panel to the opposite side, using the pre-arranged holes.
- Replace the instrument panel.

NOTE: Keep the door closed when removing and installing the brackets.

REFRIGERANT MATERIAL SAFETY DATA SHEET

R404a: fluid components

trifluoroethane	(HFC 143a)	52%
pentafluoroethane	(HFC 125)	44%
tetrafluoroethane	(HFC 134a)	4%

GWP = 3750
ODP = 0

Hazard identification

Overexposure through inhalation may cause anaesthetic effects. Acute overexposure may cause cardiac rhythm disorders and sudden death. Product mists or sprays may cause ice burns of eyes and skin.

First aid procedures

• Inhalation:

keep injured person away from exposure, warm and relaxed. Use oxygen, if necessary. Give artificial respiration if respiration has stopped or is about to stop. In case of cardiac arrest give external cardiac massage. Seek immediate medical attention.

• Skin:

use water to remove ice from affected areas. Remove contaminated clothes.

CAUTION: clothes may adhere to skin in case of ice burns.

In case of contact with skin, wash with copious quantities of lukewarm water. In case of symptoms (irritation or blisters) seek medical attention.

• Eyes:

immediately wash with ocular solution or fresh water, keeping eyelids open for at least 10 minutes. Seek medical attention.

• Ingestion:

it can cause vomit.. If conscious, rinse mouth with water and drink 200-300 ml of water. Seek medical attention.

• Other medical treatment:

symptomatic treatment and support therapy when indicated. Do not administer adrenaline or sympatheticomimetic drugs after exposure, due to the risk of arrhythmia and possible cardiac arrest.

Environmental data

Persistence and degradation

• HFC 143a:

slow decomposition in lower atmosphere (troposphere). Duration in atmosphere is 55 years.

• HFC 125:

slow decomposition in lower atmosphere (troposphere). Duration in atmosphere is 40 years.

• HFC 134a:

relatively rapid decomposition in lower atmosphere (troposphere). Duration in atmosphere is 15.6 years.

• HFC 143a, 125, 134a:

does not affect photochemical smog (not included in volatile organic components – VOC – as established in the UNECE agreement). Does not cause ozone rarefaction.

Product exhausts released in the atmosphere do not cause long-term water contamination.

THE INSTRUCTION HANDBOOK CONTAINS A WIRING DIAGRAM ON THE LAST PAGE

POS	DESCRIPTION	POS	DESCRIPTION
1	COMPRESSOR UNIT	44	RELAY COMPRESSOR
2	COMPRESSOR FAN	44A	RELAY PTC
3	GENERAL TERMINAL BOARD	44B	RELAY MAGNETIC MICRO-SVWITCH
6	MAIN SWITCH WITH PILOT	56	FILTER
8	PLUG	69	GROUNDING TERMINAL
9	EVAPORATOR FUN	70	HIGHT-PRESSURE SAFETY PRESSUR SWITCH
9A	EVAPORATOR FUN	75	SOLENOID VALVE
9B	EVAPORATOR FUN	76	MAGNETIC MICRO-SVWITCH
10	INTERNAL LIGHTING LAMP	85	CONNECTION BOX
10A	INTERNAL LIGHTING LAMP	86	CONDENSER PROBE
12	SOLENOID VALVE DEFROSTING	90	DIGITAL THERMOREGULATOR
14	HUMIDITY VARIATOR WITH PILOT	91	PTC RESISTOR
15	MICRO FAN-SWITCH	96	ELECTRONIC CARD
15A	MICRO FAN-SWITCH	101	BUFFER RESISTANCE
18	SECURITY THERMOSTAT PILOT	102	BIMETALLIC SAFETY THERMOSTAT
19	THERMOSTAT PILOT	103	HUMIDITY PROBE
20	DOOR ANTICONDENSING RESISTOR	104	LEVEL ADJUSTER
20A	DOOR ANTICONDENSING RESISTOR	105	LEVEL PROBE
21	TRY BOTTOM RESISTOR	106	VAPOR GENERATOR SAFETY THERMOSTAT
22	RESISTANCE FOUND BASIN	107	CHAMBER ELECTRIC RESISTANCE
25	TRANSFORMER	108	VAPOR GENERATOR RESISTANCE
28	INTERNAL LIGHTING SWITCH	109	RETARDER-PROVER PANEL CARD
29	TL LAMPS BALLAST	110	RETARDER-PROVER CONTROL CARD
30	STARTER	111	RETARDER-PROVER REALY EXPANSION CARD
31	TL LAMP	112	HUMIDIFICATION WATER ELECTROVALVE

INDICE

DESCRIPTION DE LA MAQUINA	2
ACCESORIOS	2
ETIQUETA DE IDENTIFICATION	2
NOTAS GENERALES PARA LA ENTREGA	3
NORMAS DE SEGURIDAD	3
DISPOSICIONES HACCP	4
CARACTERISTICAS TECNICAS	4
COLOCACION EN SU LUGAR E INSTALACION	4
TABLEROS DE MANDO	6
ARRANQUE	7
CARGA DEL PRODUCTO	7
FUNCIONAMIENTO CICLO MANUAL – CICLO AUTOMÁTICO	7
PARADA	12
DESCONGELATION	13
REGULACIÓN DEL RELOJ	13
REGULACIÓN DE LA HORA LOCAL	13
IDIOMA	14
PROGRAMACION	14
ALARMAS	20
ANORMALIDADES DE FUNCIONAMIENTO	21
LIMPIEZA DIARIA	21
MANCHAS DE ALIMENTOS Y RESIDUOS ENDURECIDOS	22
LIMPIEZA Y MANTENIMIENTO PERIÓDICOS	22
INTERRUPCIONES EN EL FUNCIONAMIENTO	23
CONSEJOS UTILES PARA LA MANUTENCION DEL ACERO INOXIDABLE	23
PROBLEMAS DE FUNCIONAMIENTO	23
DESPACHO DE RESIDUOS Y DEMOLICION	24
INVERSIÓN PUERTA	24
FICHA TÉCNICA DEL REFRIGERANTE	25

DESCRIPTION DE LA MAQUINA

Este aparato ha sido proyectado para la refrigeración, el calentamiento y la conservación de los alimentos. otro uso tiene que considerarse inadecuado.

ATENCION: las máquinas no son idóneas para ser instaladas al aire libre y/o en ambientes sometidos a acciones de agentes atmosféricos.

El fabricante declina toda responsabilidad por usos no previstos.

Los aparatos están disponibles con puertas de acero.

Los aparatos están realizados con equipos de refrigeración a "NORMAL TEMPERATURA" y a "BAJA TEMPERATURA" para permitir la conservación de los alimentos a distintas temperaturas. (1)

Los aparatos están dotados de un evaporador con aletas protegido contra la oxidación, de un compresor hermético, de un condensador en cobre-aluminio, de un kit humidificación, de una resistencia interna, de una sonda humedad y relativo panel de mandos. (2)

Los aparatos están dotados de un panel de mandos, diferenciado por el tipo de regulaciones referidas a la tipología de aparato (TEMPERATURA POSITIVA, BAJA TEMPERATURA). (3)

Los compresores están alojados en la parte superior de las aparatos para asegurar una buena ventilación y dispersión del calor. (4)

Los aparatos están dotados de una bandeja, dotada de un dispositivo de evaporación automático de la condensación, alojada sobre la parte posterior externa del aparato. (5)

Ningún compartimiento frigorífico está equipado con cubeta para la recolección del líquido de condensación.

Los aparatos están dotados de dos diferentes sistemas de iluminación en función del modelo. Las lámparas internas están protegidas para evitar el contacto con alimentos y contra golpes que podrían romperlas. (8)

Las puertas de las aparatos tienen una cerradura con llave para asegurar un cierre seguro. (9)

Las zonas que están en contacto con el producto están realizadas de acero o revestidas de material plástico atóxico. (10)

En los grupos refrigerantes se usa fluido refrigerante permitido por las legislaciones actuales del tipo HFC.

ACCESSORIOS

Ver figura 7.

ETIQUETA DE IDENTIFICATION

Ante cualquier comunicación con el constructor citar siempre el MODELO y el NUMERO DE MATRICULA de la máquina colocada sobre la placa características técnicas. (11)

Contenido del campo eléctrico de la tarjeta tecnica de el aparato (12)

- | | |
|--|---|
| 1) MODELO | F) CORRIENTE DE EL FUSIBLE |
| 2) EMPRESA DE CONSTRUCCION | G) TIPO DE GAS DE EL REFRIGERANTE |
| 3) SIGLA MARCA CEE | H) CANTIDAD DE EL GAS REFRIGERANTE |
| 4) ANO DE CONSTRUCCION | L) TIPO DE TEMPERATURA DE LA INSTALLACION DEL FRIGORIFICO |
| 5) NUMERO DE MATRICULA | M) PRESION MAXIMA AGUA |
| 6) CLASE DE AISLAMIENTO ELECTRICO | N) TEMPERATURA AGUA |
| 7) CLASE DE PROTECCION ELECTRICA | O) CONSUMO AGUA |
| A) VOLTAJE DE ALIMENTACION ELECTRICA | P) PRESION MINIMA AGUA |
| B) INTENSIDAD DE LA CORRIENTE ELECTRICA | R) SÍMBOLO RAEE |
| C) FRECUENCIA DE LA ALIMENTACION ELECTRICA | W) POTENCIA DE LOS ELEMENTOS DE CALEFACCION |
| D) POTENCIA NOMINAL | |
| E) POTENCIA TOTAL | |

NOTAS GENERALES PARA LA ENTREGA

Cuando se recibe el bulto, controlar que el embalaje esté intacto y que no haya sufrido daños durante el transporte. (13)

Después de haber desembalado la aparato, controlar que estén todas las partes o componentes y que las características y el estado correspondan a las especificaciones de la orden de compra.

Si así no fuera, ponerse en contacto inmediatamente con el vendedor. (14)

Les felicitamos por vuestra óptima elección y les auguramos que podáis utilizar del mejor modo nuestros armarios frigoríficos siguiendo las indicaciones y las precauciones necesarias contenidas en este manual. (15)

Pero recordad que está prohibida la reproducción del presente manual y que, debido a una constante búsqueda de innovación y calidad tecnológica, las características aquí presentes podrían cambiar sin preaviso.

NORMAS DE SEGURIDAD

ATENCIÓN: antes de cualquier operación de manutención o limpieza, es necesario aislar el equipo de la red eléctrica.

Llevar el interruptor presente sobre el panel en posición OFF (16a)

poner el interruptor general en posición OFF. (16b)

desenchufar el equipo (17)

ATENCIÓN: no utilizar tomacorrientes o enchufes desprovistos de puesta a tierra. (18)

El tomacorrientes de la red eléctrica debe tener su CABLE DE TIERRA. (19)

ATENCIÓN: para enchufar en la red, no utilizar adaptadores o prolongadores de cable. (20)

ATENCIÓN: esperar el tiempo necesario para alcanzar la temperatura determinada antes de poner adentro los alimentos a conservar. (21)

Cubrir siempre los alimentos con la película antes de ponerlos en las aparatos. (22)

ATENCIÓN: no introducir en la aparato bebidas o alimentos calientes. (23)

ATENCIÓN: Proveer al almacenamiento de los productos para que se conserven de manera tal para que no sobresalga de las rejillas de manera que no obstaculize la corriente de aire. No obstaculizar la zona de aspiración de los ventiladores. (24)

ATENCIÓN: no limpiar las zonas cercanas a la aparato cuando la puerta está abierta.

No lave el equipo con chorros de agua directa y a alta presión. (26)

ATENCIÓN: no usar sustancias a base de cloro (lavandina, ácido muriático, etc.) o, de todos modos, tóxicas para limpiar adentro o cerca de las aparatos. (27)

ATENCIÓN: no obstruir la parte superior de la aparato o las tomas de aire cuando el aparato está en funcionamiento o bajo tensión eléctrica. (28)

ATENCIÓN: no objetos en el fondo del frigorífico. Utilice las rejillas específicas.(29)

El peso máximo distribuido sobre las rejillas, tiene que ser de 48 Kg.

La limpieza y la manutención de la instalación refrigeradora y de la zona compresores requiere la intervención de un técnico especializado y autorizado; por lo tanto no pueden ser efectuadas por personal no preparado. (30)

Para intervenciones de manutención o en caso de anomalías, desenchufar completamente el equipo y solicitar la intervención del SERVICIO DE ASISTENCIA a un centro autorizado y el empleo de repuestos originales. (31)

No respetar las precauciones indicadas puede comprometer el estado de seguridad de los aparatos.

DISPOSICIONES HACCP

ATENCIÓN: Los alimentos fácilmente perecederos hay que sacarlos del ambiente refrigerado lo más tarde posible al fin de quedar expuestos a la temperatura ambiente el tiempo indispensable.

ATENCIÓN: No recongelar alimentos precedentemente descongelados.

ATENCIÓN: Numerar los equipos y controlar dos veces al día la temperatura relevada registrando los valores en una hoja especial que debe conservarse por 24 meses.

ATENCIÓN: Eventuales interrupciones de corriente a los frigoríficos pueden efectuarse controlando el tiempo detenido con un reloj eléctrico al fin de eliminar los alimentos que pudieran dañarse.

Temperaturas máximas admitidas para la mercadería

Alimento	Temperatura normal de almacenamiento (°C)	Temperatura máxima de transporte (°C)
Leche fresca pasteurizada	0÷+4	9
Nata fresca	0÷+4	9
Yoghurt, ricota y quesos frescos	0÷+2	9
Productos de la pesca bajo hielo	0÷+2	0÷+4

CARACTERISTICAS TECNICAS

En las últimas páginas de libro instrucciones: características técnicas. (32)

COLOCACION EN SU LUGAR E INSTALACION

Los aparatos se despachan siempre embalados y sobre palets. (33)

Cuando se reciben y después de haberlas desembalado, en caso de daños o falta de partes, seguir las instrucciones del capítulo "NOTAS GENERALES PARA LA ENTREGA".

Las operaciones de puesta en marcha y de instalación deben ser efectuadas por personas especializadas. (30)

Remover la caja de embalaje con cuidado para no magullar las superficies del equipaje. (34)

CUIDADO: los elementos del embalaje (las bolsas de plástico, el poliéster, los clavos, etc) no deben dejarse al alcance de los niños porque pueden ser causa de peligros.

Con un carrito de horquilla levantar el aparato y llevarla al lugar de su instalación, prestando atención a que la carga no esté desbalanceada. (35)

ATENCIÓN: no transportar nunca el frigorífico en posición horizontal; tal operación puede causar daños a las instalaciones y estructuras del frigorífico. (36)

ATENCIÓN: tanto para el posicionamiento en su lugar como para desplazamientos futuros, no empujar o arrastrar el aparato para evitar que se caiga o que se dañen algunas de sus partes. (37)

ATENCIÓN: no colocar la aparato cerca de fuentes de calor o en en ambientes con temperaturas elevadas pues esto causaría un menor rendimiento y mayor desgaste del mismo. (38)

ATENCIÓN: Mantener el aparato a una distancia del techo de al menos 50 cm. Es posible colocarlos uno al lado del otro, pero en el caso de formación de condensación, alejarlos de al menos 2 cm.

Remover la película protectora de el producto.

Esta operación puede provocar un choque leéctrico, aunque no sea peligroso (electricidad estática).

El inconveniente se puede reducir o eliminar manteniendo una mano siempre en contacto con el aparato o colegando a tierra el embalaje exterior. (39)

Después de haber colocado la aparato en su lugar, quitar el palet con un escoplo y un martillo, prestando atención a no dañar las patitas dentro de las barras o la aparato misma. (40)

Quitar la barra de refuerzo de madera de las ranuras en la parte inferior. (41)

El tubo de descarga sifón presente debajo del aparato debe ser conectado directamente a la red de alcantarillado con desagüe abierto. (41a)

El tubo de alimentación (unión 3/4") agua presente en la parte superior del aparato debe ser conectado a la red hídrica a través de una válvula de interceptación, un filtro de cartucho y válvula de retención. (41b)

La temperatura del agua de alimentación debe estar entre 5°C y 40°C.

La presión del agua debe ser suficiente para garantizar un buen funcionamiento del aparato (>1bar).

Si el agua empleada es particularmente rica de impurezas se aconseja utilizar filtros o depuradores apropiados para tratarla.

A este punto es posible es posible regular las patitas. (42)

Nivelar el aparato teniéndolo levemente inclinado en la parte de atrás para permitir el cierre optimal de la\las puerta\ls. (43)

Limpiar con agua tibia y jabón neutro (como indica el capítulo "LIMPIEZA") y montar los accesorios ubicados dentro de la aparato.

El frigorífico está compuesto por un enchufe del tipo SHUKO. Comprobar la correspondencia de la misma con las normas EN60320 y a las normas nacionales. Sustituir el enchufe con uno en la norma en el caso que no tuaviese que corresponder. (44)

ATENCIÓN: La operación deve ser efectuada por un técnico especializado. (30)

Controlar que la tensión de red corresponda a la indicada en la placa de las características técnicas del equipo. (45)

Enchufar el aparato en el tomacorriente. (46)

A este punto han terminado las operaciones de colocación en su lugar del equipo e instalación.

El equipo debe tenerse dentro de un sistema con igual potencia, la eficiencia de este tiene que ser verificada según las normas en vigor. La unión viene efectuada mediante un tornillo contrasinado con la sigla "Equipotencial" que se encuentra en la zona compresores. (47)

TABLEROS DE MANDO

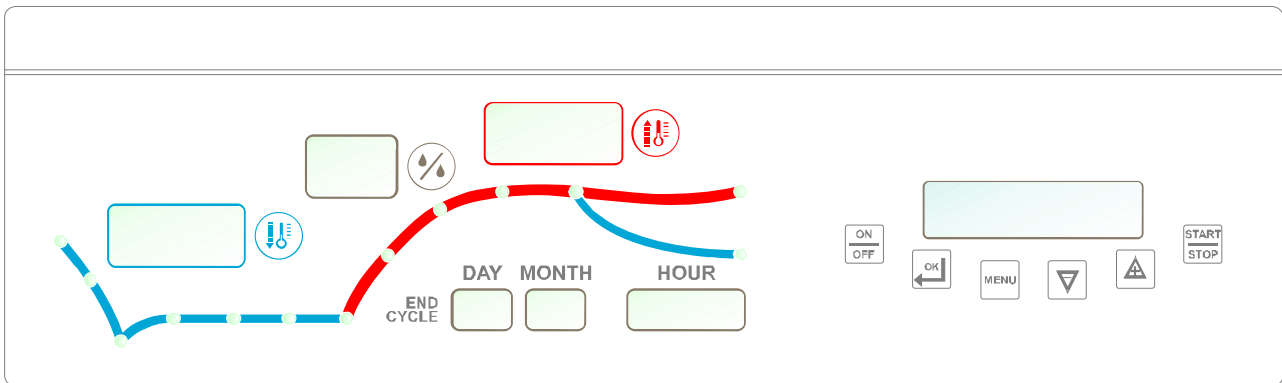

	<p><u>Tecla ON/OFF</u> Pulsando la tecla durante 3 seg el controlador se apaga y sobre el display aparece el texto OFF _</p> <p>Pulsando a continuación la tecla, el controlador se vuelve a encender y es visualizado 02/01/2009 Mar 17:35</p>
	<p><u>Tecla Enter</u> Permite acceder a un menú o seleccionar un parámetro.</p> <p><i>Durante un ciclo, la presión de la tecla permite visualizar la fecha y la hora.</i></p>
	<p><u>Tecla Menù</u> Permite acceder al menú principal o volver al menú precedente.</p>
	<p><u>Teclas Up e Down</u> Permiten pasar a los diferentes menús o variar los valores de los parámetros.</p>
	<p><u>Tecla Start/Stop</u> Permite activar/bloquear un ciclo.</p> <p><i>Con el aparato en reposo, pulsando la tecla durante 3 seg, parte automáticamente el programa relacionado al día de la semana en el que se realiza la activación.</i></p>
	<p>Visualiza la temperatura en cámara durante la fase de refrigeración, conservación o interrupción fermentación.</p>
	<p>Visualiza el porcentaje de humedad en cámara. <i>Es encendido durante la sfases en el que está previsto el control de la humedad.</i></p>
	<p>Visualiza la temperatura en cámara durante la fase de calentamiento, climatización, fermentación ralentamiento o reanudación</p>
	<p>Indican la fecha y la hora. <i>Visualizan día, mes y hora real con tarjeta in standby o ciclo manual en curso. Visualizan día, mes y hora de final del ciclo, si el ciclo automático está en curso.</i></p>

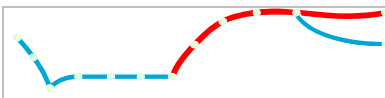

Visualiza el estado de avance del ciclo seleccionado.
 Los led correspondientes a las fases ya concluidas permanecen encendidos durante la ejecución de las siguientes fases.

La tarjeta prevee la posibilidad de regular ciclos **automáticos** o efectuar un ciclo **manual**.

Ciclo manual: regulación de las 3 fases:
 REFRIGERACION, CALENTAMIENTO Y CLIMATIZACION

Ciclos automáticos: (7 ciclos regulados y/o modificables) constituidos por las siguientes fases:
 BLOQUEO DE LA FERMENTACION, CONSERVACION, REANUDACION, FERMENTACION Y
 RALENTAMIENTO

ARRANQUE

Para poner en marcha el aparato realice la siguientes operaciones :

- enchufarla en el tomacorriente de red; (50)
- coloque el interruptor de línea en la posición ON; (51)
- pulsar la tecla ;

Se visualiza

CARGA DEL PRODUCTO

- A este punto y no antes es posible poner adentro los alimentos a conservar.
- Distribuir el producto en el interior de la celda de manera uniforme para permitir la circulación de aire.
- Evitar la obstrucción de las zonas de ventilación en el interior del frigorífico. Dentro de la celda hay adhesivos que indican el límite de carga de las rejillas.
- No dejar la puerta abierta, más de lo necesario, cuando se sacan o ponen alimentos.
- Se aconseja tener las llaves lejos del alcance de los niños.







FUNCIONAMIENTO

CICLO MANUAL

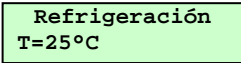











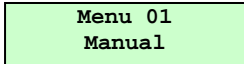

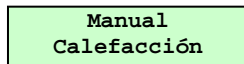

El ciclo manual está constituido por 3 fases independientes y el pasaje de una fase a otra no es automático.

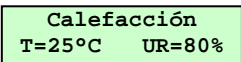
FASE DE REFRIGERACION

	Apretar el botón <u>menú</u> para seleccionar el menú deseado
	Utilizar las teclas <u>up</u> y <u>down</u> para visualizar
	Presionar la tecla <u>enter</u> para confirmar la selección.
	Utilizar las teclas <u>up</u> y <u>down</u> para visualizar





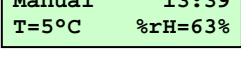









	Presionar la tecla <u>enter</u> para confirmar la selección. Se visualiza 
	Pulsar la tecla <u>enter</u> para entrar en el modo de modificación de los SetPoint. <i>El valor del SetPoint Temperatura parpadea, utiliza las teclas  y  para modificar el valor</i>
	Pulsar la tecla <u>enter</u> para confirmar el nuevo valor
	Pulsar la tecla <u>start/stop</u> para activar inmediatamente la fase seleccionada. Se visualiza 

FASE DE CALENTAMIENTO

	Apretar el botón <u>menú</u> para seleccionar el menú deseado
 	Utilizar las teclas <u>up</u> y <u>down</u> para visualizar 
	Presionar la tecla <u>enter</u> para confirmar la selección.
 	Utilizar las teclas <u>up</u> y <u>down</u> para visualizar 
	Presionar la tecla <u>enter</u> para confirmar la selección. Se visualiza 
	Pulsar la tecla <u>enter</u> para entrar en el modo de modificación de los SetPoint. <i>El valor del SetPoint Temperatura parpadea, utiliza las teclas  y  para modificar el valor</i>
	Presionar la tecla <u>enter</u> para confirmar la selección. <i>El valor del SetPoint de Humedad parpadea, utilizar las teclas  y  para modificar el valor</i>
	Presionar la tecla <u>enter</u> para confirmar la selección.
	Pulsar la tecla <u>start/stop</u> para activar inmediatamente la fase seleccionada. Se visualiza 

FASE DE CLIMATIZACIÓN

	Apretar el botón <u>menú</u> para seleccionar el menú deseado
---	---

 	Utilizar las teclas <u>up</u> y <u>down</u> para visualizar Menu 01 Manual
	Presionar la tecla <u>enter</u> para confirmar la selección
 	Utilizar las teclas <u>up</u> y <u>down</u> para visualizar Manual Climatización
	Presionar la tecla <u>enter</u> para confirmar la selección. Se visualiza Climatización T=25°C UR=80%
	Pulsar la tecla <u>enter</u> para entrar en el modo de modificación de los SetPoint. <i>El valor del SetPoint Temperatura parpadea, utiliza las teclas  y  para modificar el valor</i>
	Pulsar la tecla <u>enter</u> para confirmar el nuevo valor. <i>El valor del SetPoint de Humedad parpadea, utilizar las teclas  y  para modificar el valor</i>
	Pulsar la tecla <u>enter</u> para confirmar el nuevo valor
	Pulsar la tecla <u>start/stop</u> para activar inmediatamente la fase seleccionada. Se visualiza Manual 13:39 T=5°C %rH=63%

CICLO AUTOMÁTICO

La tarjeta electrónica tiene memorizados los siguientes 7 ciclos automáticos

APARATOS -5°C / +30°C

CICLO		P1	P2	P3	P4	P5	P6	P7
		Lunes	Martes	Miércoles	Jueves	Viernes	Sábado	Domingo
BLOQUEO	Duración	02:00	02:00	02:00	02:00	02:00	02:00	02:00
	Temperatura	-5°C	-5°C	-5°C	-5°C	-5°C	-5°C	-5°C
CONSERVACIÓN	Temperatura	-1°C	-1°C	-1°C	-1°C	-1°C	-1°C	-1°C
INTERRUPCIÓN	Duración	02:00	02:00	02:00	02:00	02:00	02:00	02:00
	Temperatura	20°C	20°C	20°C	20°C	20°C	20°C	20°C
	Humedad	70%	70%	70%	70%	70%	70%	70%
FERMENTACIÓN	Duración	02:00	02:00	02:00	02:00	02:00	02:00	02:00
	Temperatura	28°C	28°C	28°C	28°C	28°C	28°C	28°C
	Humedad	80%	80%	80%	80%	80%	80%	80%
FINALIZACIÓN DEL PROGRAMA	Hora	01:00	01:00	01:00	01:00	01:00	01:00	01:00
BLOQUEO	Temperatura	6°C	6°C	6°C	6°C	6°C	6°C	6°C
	Humedad	80%	80%	80%	80%	80%	80%	80%

APARATOS -18°C / +30°C

CICLO		P1	P2	P3	P4	P5	P6	P7
		Lunes	Martes	Miércoles	Jueves	Viernes	Sábado	Domingo
BLOQUEO	Duración	02:00	02:00	02:00	02:00	02:00	02:00	02:00
	Temperatura	-20°C	-20°C	-20°C	-20°C	-20°C	-20°C	-20°C
CONSERVACIÓN	Temperatura	-1°C	-1°C	-1°C	-1°C	-1°C	-1°C	-1°C
INTERRUPCIÓN	Duración	02:00	02:00	02:00	02:00	02:00	02:00	02:00
	Temperatura	20°C	20°C	20°C	20°C	20°C	20°C	20°C
	Humedad	70%	70%	70%	70%	70%	70%	70%

FERMENTACIÓN	Duración	02:00	02:00	02:00	02:00	02:00	02:00	02:00
	Temperatura	28°C	28°C	28°C	28°C	28°C	28°C	28°C
	Humedad	80%	80%	80%	80%	80%	80%	80%
FINALIZACIÓN DEL PROGRAMA	Hora	01:00	01:00	01:00	01:00	01:00	01:00	01:00
BLOQUEO	Temperatura	6°C	6°C	6°C	6°C	6°C	6°C	6°C
	Humedad	80%	80%	80%	80%	80%	80%	80%









APARATOS -2°C / +30°C

CICLO		P1	P2	P3	P4	P5	P6	P7
		Lunes	Martes	Miércoles	Jueves	Viernes	Sábado	Domingo
BLOQUEO	Duración	02:00	02:00	02:00	02:00	02:00	02:00	02:00
	Temperatura	-2°C	-2°C	-2°C	-2°C	-2°C	-2°C	-2°C
CONSERVACIÓN	Temperatura	+2°C	+2°C	+2°C	+2°C	+2°C	+2°C	+2°C
INTERRUPCIÓN	Duración	02:00	02:00	02:00	02:00	02:00	02:00	02:00
	Temperatura	20°C	20°C	20°C	20°C	20°C	20°C	20°C
	Humedad	70%	70%	70%	70%	70%	70%	70%
FERMENTACIÓN	Duración	02:00	02:00	02:00	02:00	02:00	02:00	02:00
	Temperatura	28°C	28°C	28°C	28°C	28°C	28°C	28°C
	Humedad	80%	80%	80%	80%	80%	80%	80%
FINALIZACIÓN DEL PROGRAMA	Hora	01:00	01:00	01:00	01:00	01:00	01:00	01:00
BLOQUEO	Temperatura	6°C	6°C	6°C	6°C	6°C	6°C	6°C
	Humedad	80%	80%	80%	80%	80%	80%	80%

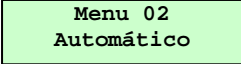
*Nota: Temperatura máxima pasta 27°C – harina vxx 320 – aumentar 0,01 levadura – aumentar 0,01 sal para productos salados o azúcar para productos dulces

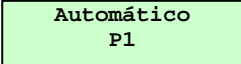
Cada ciclo automático está constituido por 5 cinco fases.

El ciclo inicia siempre por la fase de BLOQUEO DE LA FERMENTACION y el pasaje a las fases sucesivas sucede en modo **automático** en base a la duración de cada fase y al día y hora de terminación del ciclo regulados.

	Apretar el botón <u>menú</u> para seleccionar el menú deseado
	Utilizar las teclas <u>up</u> y <u>down</u> para visualizar 
	Presionar la tecla <u>enter</u> para entrar en la selección de los programas ya memorizados (P01... P07). Se visualiza 
	Utilizar las teclas <u>up</u> y <u>down</u> para seleccionar el programa que se desea
	Presionar la tecla <u>enter</u> . Se visualiza 













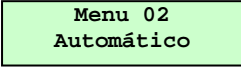

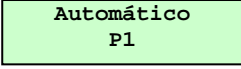









Si la fecha de finalización indicada es aquella deseada, pulsar la tecla  , para confirmar y activar

La ejecución del ciclo, de todos modos pulsar la tecla  para modificar la fecha de finalización del ciclo.

MODIFICACIÓN DEL CICLO AUTOMÁTICO

Para variar los ciclos regulados anteriormente seguir las siguientes instrucciones.

	Apretar el botón <u>menú</u> para seleccionar el menú deseado
---	---

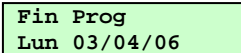

 	Utilizar las teclas <u>up</u> y <u>down</u> para visualizar 
	Presionar la tecla <u>enter</u> para entrar en la selección de los programas ya memorizados (P01... P07). Se visualiza 
 	Utilizar las teclas <u>up</u> y <u>down</u> para seleccionar el programa que se desea
	Pulsar la tecla <u>enter</u> para entrar en el modo de configuración del programa que se desea
	Con la tecla <u>down</u> es posible pasar de una fase a la otra y sobre el display se visualiza la fase del ciclo con los valores corrientes de los setpoint
	Pulsar la tecla <u>enter</u> para entrar en modificación. El valor de las Horas inicia a parpadear. <i>Utilizar las teclas  y  para modificar el valor.</i>
	Pulsar la tecla <u>enter</u> para confirmar el nuevo valor, el dato no parpadea más. El valor de las minutos inicia a parpadear. <i>Utilizar las teclas  y  para modificar el valor..</i>
	Pulsar la tecla <u>enter</u> para confirmar el nuevo valor, el dato no parpadea más. El valor del <i>SetPoint de Temperatura</i> parpadea. <i>Utilizar las teclas  y  para modificar el valor.</i>
	Pulsar la tecla <u>enter</u> para confirmar el nuevo valor, el dato no parpadea más. El valor del <i>SetPoint de Humedad</i> parpadea (si está presente). <i>Utilizar las teclas  y  para modificar el valor.</i>
	Pulsar la tecla <u>enter</u> para confirmar el nuevo valor, el dato no parpadea más. <i>Utilizar las teclas  y  para seleccionar otras fases y modificar los Setpoint.</i>

La presión de la tecla  permite la memorización del programa y la posibilidad de volver al menú anterior.

La presión de la tecla  permite activar la ejecución del programa, el display visualiza la fecha de finalización de ciclo. 

Si la fecha de finalización indicada es aquella deseada, pulsar la tecla , para confirmar y activar

La ejecución del ciclo, de todos modos pulsar la tecla  para modificar la fecha de finalización del ciclo.

El día parpadea, con la tecla  desplazar la fecha de finalización del programa, pulsar la tecla  para confirmar la nueva fecha y pulsar la tecla  para activar la ejecución del ciclo.

EJECUCIÓN DE UN CICLO AUTOMÁTICO

Durante la ejecución de un ciclo automático el display visualiza:

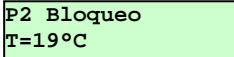

Indicando el número del programa en curso, la fase en curso, la temperatura actual de la celda y si la fase prevee también la humidificación con sonda, se visualiza el porcentaje de humedad presente.

Visualizar fecha y hora de las fases

Pulsar la tecla  para visualizar la fecha y la hora de finalización de la fase en curso.

Pulsar la tecla  para visualizar la fecha y la hora de finalización de las fases sucesivas.

Se visualiza 

Donde Fase0 indica que está en curso la fase 0 del programa, precisamente la fase de Bloqueo.

Las otras fases están indicadas con:

Fase1 que indica Conservación

Fase2 que indica Interrupción

Fase3 que indica Fermentación

Fase4 que indica Desaceleración

La presión de la tecla , o bien del timeout durante 5 segundos, hacen volver a la visualización anterior.

Visualizar el estado INPUT/OUTPUT

Pulsar la tecla  para visualizar el estado de los INPUT/OUTPUT.

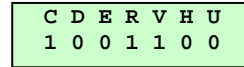

La presión de la tecla , o bien del timeout durante 20 segundos, hacen volver a la visualización anterior.

Visualizar fecha y hora









Pulsar la tecla  para visualizar la fecha y la  hora.

La presión de la tecla , o bien del timeout durante 5 segundos, hacen volver a la visualización anterior.

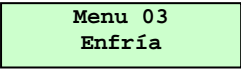
En cualquier instante la presión de la tecla  bloquea la ejecución del ciclo. El ciclo permanece de todos modos seleccionado.

CICLO DE ENFRIAMIENTO

Se aconseja activar un ciclo de enfriamiento antes de seleccionar un ciclo cualquiera.

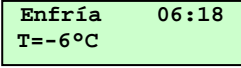
	Apretar el botón <u>menú</u> para seleccionar el menú deseado
 	Utilizar las teclas <u>up</u> y <u>down</u> para visualizar 
	Pulsar la tecla <u>enter</u> para entrar en el modo de modificación de los SetPoint. <i>El valor del SetPoint Temperatura parpadea, utiliza las teclas  y  para modificar el valor.</i>
	Pulsar la tecla <u>enter</u> para confirmar el nuevo valor
	Apretar el botón <u>start/stop</u> para activar inmediatamente el ciclo de enfriamiento Se visualiza 

Pulsando la tecla  es posible volver a la modificación del SetPoint.



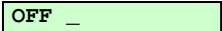

PARADA

Ante cualquier condición para detener el aparato es suficiente pulsar la tecla  ;
sobre el display se visualiza 

ATENCIÓN: la tecla  NO aísla el aparato de la tensión eléctrica.

Para aislar el aparato de la tensión eléctrica sacar el enchufe de la toma de corriente. (17)

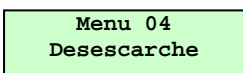

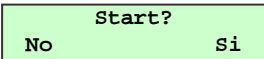





DESCONGELATION

	Apretar el botón <u>menú</u> para seleccionar el menú deseado
	Utilizar las teclas <u>up</u> y <u>down</u> para visualizar 
	Presionar la tecla <u>enter</u> para acceder al pedido start de descarche Se visualiza 

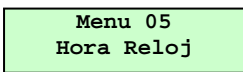

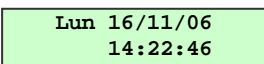





Pulsar la tecla  para salir del menú y la descongelación no es activada.

Pulsar la tecla  para activar la descongelación.

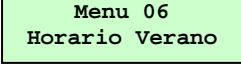

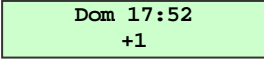





REGULACIÓN DEL RELOJ

	Apretar el botón <u>menú</u> para seleccionar el menú deseado
	Utilizar las teclas <u>up</u> y <u>down</u> para visualizar 
	Presionar la tecla <u>enter</u> para entrar en la modalidad de regulación reloj. Se visualiza  Utilizar las teclas  y  para modificar la cifra que parpadea
	Presionar la tecla <u>enter</u> para confirmar el valor y pasar al dato sucesivo
	Presionar la tecla <u>menú</u> para salir de la selección

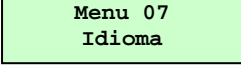
REGULACIÓN DE LA HORA LOCAL

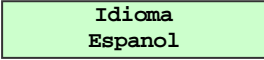
	Apretar el botón <u>menú</u> para seleccionar el menú deseado
	Utilizar las teclas <u>up</u> y <u>down</u> para visualizar 
	Pulsar la tecla <u>enter</u> para entrar en el modo de configuración de la hora local. Se visualiza  Utilizar las teclas  y  para modificar la hora
	Pulsar la tecla <u>enter</u> para confirmar el nuevo valor
	Presionar la tecla <u>menú</u> para salir de la selección

IDIOMA













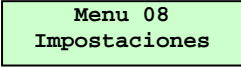

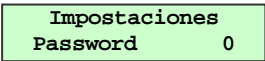

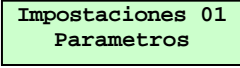

	Apretar el botón <u>menú</u> para seleccionar el menú deseado
	Utilizar las teclas <u>up</u> y <u>down</u> para visualizar 
	Pulsar la tecla <u>enter</u> para visualizar el idioma actualmente utilizado. Se visualiza 
	Utilizar las teclas <u>up</u> y <u>down</u> per visualizar la lengua deseada
	Presionar la tecla <u>enter</u> para confirmar la elección
	Presionar la tecla <u>menú</u> para salir de la selección

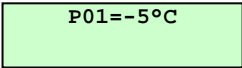
PROGRAMACION

PARAMETROS

Modificacion Parametros

	Apretar el botón <u>menú</u> para seleccionar el menú deseado
---	---

 	Utilizar las teclas <u>up</u> y <u>down</u> para visualizar 
	Presionar la tecla <u>enter</u> para confirmar la elección. Se visualiza 
 	Utilizar las teclas <u>up</u> y <u>down</u> para seleccionar la password “-19”
	Presionar la tecla <u>enter</u> para confirmar la elección. Se visualiza el primer submenú 
	Presionar la tecla <u>enter</u> para entrar en la modalidad de programación parámetros Se visualiza el primer parámetro 
 	Utilizar las teclas <u>up</u> y <u>down</u> para hojear todos los parámetros del controlador
	Presionar la tecla <u>enter</u> para confirmar la elección
 	Utilizar las teclas <u>up</u> y <u>down</u> para seleccionar el nuevo valor del parámetro
	Presionar la tecla <u>enter</u> para confirmar la elección
	Presionar la tecla <u>menú</u> para volver al Menú Principal

Descripcion Parametros

Nr.	Descripción	Default -2/+30°C	Default -5/+30°C	Default -18/+30°C	Min	Max	Unidad
Configuraciones Generales							
P1	Seleccionada visualización a power on 0= ninguna 1= EVCO s.r.l.	1	1	1	0	1	---
P2	0 = Celsius 1 = Farhenheit	0	0	0	0	1	---
P3	Offset sonda cámara	0	-2	-2	-15	15	°C/°F
P4	Offset sonda evaporador	0	0	0	-15	15	°C/°F
P5	Límite inferior sonda humedad	0	0	0	0	P6	%
P6	Límite superior sonda humedad	100	100	100	P5	200	%
P7	Polaridad ingreso para contacto puerta 0 = NO 1 = NC	0	0	0	0	1	---
P8	Polaridad ingreso BT para termostato 0 = NO 1 = NC	0	0	0	0	1	---
P9	Duración Power down para restablecimiento programa automático	15	15	15	1	60	minutos
P10	Seleccionar comportamiento después power down para programa automático 0 = un ciclo automático vuelve a partir si el power down es menor de P9 minutos 1 = un ciclo automático vuelve a partir siempre	1	1	1	1	1	---
P11	Duración del Power down para restablecimiento del programa manual	15	15	15	1	60	minutos



Nr.	Descripción	Default -2/+30°C	Default -5/+30°C	Default -18/+30°C	Min	Max	Unidad
P12	Seleccionar comportamiento después de power down para programa manual 0 = un ciclo manual vuelve a partir si el power down es menor de P11 minutos 1 = un ciclo manual vuelve a partir siempre	1	1	1	0	1	---
Setpoint							
P13	Mín setpoint regulable frío	-2	-5	-24	-30	P14	°C/°F
P14	Máx setpoint regulable frío	10	10	5	P13	90	°C/°F
P15	Histéresis frío	2	2	2	1	10	°C/°F
P16	Zona muerta fría para refrigeración, bloqueo y conservación	0	0	0	0	10	°C/°F
P17	Zona muerta frío para calentamiento, interrupción y fermentación	0	0	0	0	10	°C/°F
P18	Zona muerta frío para climatización y desaceleración	0	0	0	0	10	°C/°F
P19	Mín setpoint regulable calor	5	5	5	0	P20	°C/°F
P20	Máx setpoint regulable calor	30	30	30	P19	90	°C/°F
P21	Histéresis calor	1	1	1	1	10	°C/°F
P22	Zona muerta calor para calentamiento, interrupción y fermentación	1	1	1	0	10	°C/°F
P23	Zona muerta calor para climatización y desaceleración	1	1	1	0	10	°C/°F
P24	Número pasos regulación resistencias en reanudación	9	9	9	1	10	---
P25	Número pasos regulación resistencias en fermentación	1	1	1	1	10	---
Tiempos del Compresor							
P26	Retraso entre dos on sucesivos del compresor	3	3	3	0	60	minutos
P27	Retraso entre un off y sucesivo on compresor	2	2	2	0	60	minutos
P28	Retraso encendido compresores de power on	1	1	1	0	255	minutos
P29	Duración del encendido forzado del compresor al inicio de la fase de interrupción, fermentación y desaceleración	0	0	0	0	60	minutos
Tiempos de Resistencias							
P30	Tiempo mínimo de activación de las resistencias	0	0	0	0	255	segundos
Humidificación y Deshumidificación							
P31	Límite inferior de la temperatura de la celda para humidificación/deshumidificación	5	5	5	0	90	°C/°F
P32	Modalidad gestión humedad 0 = con sonda humedad 1 = a ciclos de tiempo en base al porcentaje regulado 2 = a pasos de un minuto	0	0	0	0	2	---
P33	Tiempo de pausa si P32 = 2	10	10	10	0	60	minutos
P34	Duración ciclo de humidificación si P32 = 1	60	60	60	30	600	segundos
P35	Tiempo máx humidificación si P32 = 1	30	30	30	0	P34	segundos
P36	Habilitación de la humidificación en las fases de bloqueo de la fermentación y de la conservación 0 = deshabilitada 1 = habilitada	0	0	0	0	1	---
P37	Histéresis para humidificación	1	1	1	1	100	%
P38	Zona muerta para humidificación	4	4	4	0	100	%
P39	Banda de Regulación Proporcional para la Humidificación	4	4	4	0	20	%
P40	Tiempo de ciclo para Reg, Prop Humidificación	1	1	1	1	255	segundos / minutos
P41	Base de tiempos para Tiempo de Ciclo 0 = segundos 1 = minutos	1	1	1	0	1	---
P42	Histéresis para deshumidificación	1	1	1	1	100	%
P43	Zona muerta para deshumidificación	5	5	5	0	100	%
P44	Duración Tentativo de Deshumidificación con Electroválvula	1	1	1	1	255	segundos
Ventilación							
P45	Habilitación Regulación Proporcional Ventilador Evaporador 0 = regulación ON/OFF 1 = regulación proporcional	0	0	0	0	1	---
P46	Funcionamiento ventiladores evaporador para bloqueo fermentación 0 = funcionamiento en paralelo 1 = funcionamiento continuo	1	1	1	0	1	---
P47	Funcionamiento ventiladores evaporador para conservación 0 = funcionamiento en paralelo 1 = funcionamiento continuo	1	1	1	0	1	---
P48	Funcionamiento ventiladores evaporador para reanudación 0 = funcionamiento en paralelo 1 = funcionamiento continuo	0	0	0	0	1	---
P49	Funcionamiento ventiladores evaporador para fermentación 0 = funcionamiento en paralelo 1 = funcionamiento continuo	0	0	0	0	1	---









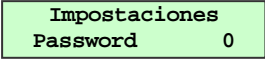
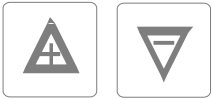

Nr.	Descripción	Default -2/+30°C	Default -5/+30°C	Default -18/+30°C	Min	Max	Unidad
P50	Funcionamiento ventiladores evaporador para ralentamiento 0 = funcionamiento en paralelo 1 = funcionamiento continuo	0	0	0	0	1	---
P51	Funcionamiento ventiladores evaporador para refrigeración 0 = funcionamiento en paralelo 1 = funcionamiento continuo	1	1	1	0	1	---
P52	Funcionamiento ventiladores evaporador para calentamiento 0 = funcionamiento en paralelo 1 = funcionamiento continuo	0	0	0	0	1	---
P53	Funcionamiento ventiladores para climatización 0 = funcionamiento en paralelo 1 = funcionamiento continuo	0	0	0	0	1	---
P54	Retraso desactivación ventiladores evaporador en funcionamiento en paralelo	1	1	1	0	255	minutos
P55	Tiempo de trabajo ventiladores evaporador si funciona en paralelo	1	1	1	0	255	minutos
P56	Tiempo de pausa ventiladores evaporador si funcionamiento en paralelo	1	1	1	0	255	minutos
P57	Velocidad Mínima Ventilador Evaporador	0	0	0	0	P58	%
P58	Velocidad Máxima Ventilador Evaporador	100	100	100	P57	100	%
P59	Velocidad Mínima Ventilador Evaporador duración del deshumificador	20	20	20	P57	P58	%
Descongelación							
P60	Temperatura Evaporador para final de la descongelación	8	8	8	-40	99	°C
P61	Intervallo tra due sbrinamenti successivi 0 = lo sbrinamento non si ripete	8	8	6	0	10	horas
P62	Durata massima ciclo di sbrinamento	10	10	30	1	120	minutos
P63	Tempo di sgocciolamento	2	2	3	0	30	minutos
P64	Stato ventole durante lo sbrinamento	0	0	0	0	1	---
P65	Durata blocco ventole dopo sgocciolamento	2	2	2	0	15	minutos
Enfriamiento							
P66	Mínimo Setpoint para Enfriamiento	-2	-5	-5	-30	P67	°C
P67	Máximo Setpoint para Enfriamiento	10	10	10	P66	30	°C
P68	Preset Enfriamiento	-2	-5	-5	P66	P67	°C
Configuraciones y Modificación de Programas							
P69	Habilitación de la Configuración de Programas	1	1	1	0	1	---
P70	Habilitación de la Modificación de Programas	1	1	1	0	1	---
P71	Gestión K3: 0=ElectroVálvula; 1= Luz; 2 = Deshumidificación	1	1	1	0	2	---
P72	Gestión Compresor con Puerta Abierta: 0 = ningún efecto ; 1= apaga compresor	0	0	0	0	1	---
P73	Tipo descongelación 0 = Resistencia; 1 = Gas Caliente	0	0	0	0	1	---
P74	Alarmas alta temperatura Evaporador	55	55	55	0	70	°C
P75	Habilita alarmas alta temperatura Evaporador: 0= no habilitado; 1= habilitado	1	1	1	0	1	---
P76	Habilitación de la Dehumificación 0= deshabilitada 1= habil. en Interrupción, Fermentación, Desaceleración, Climatización, Calentamiento 2=habilitada también en Bloqueo y Conservación	0	0	0	0	2	---
P77	Tiempo Resistencia ON	3	3	3	1	255	segundos / minutos
P78	Tiempo Resistencia OFF (0= resistencias siempre encendidas)	1	1	1	0	255	segundos / minutos

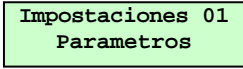
Nota

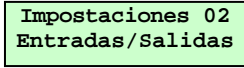

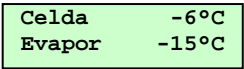

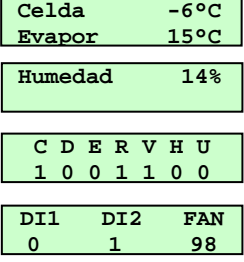



- Controlar los tiempos de protección del compresor debido a que por defecto son configurados a cero.
- Los parámetros P5 y P6 se utilizan para definir el range de la sonda humedad. El parámetro P5 debe ser puesto igual al porcentaje de humedad correspondiente a 4mA y el parámetro P6 debe ser puesto igual al porcentaje de humedad correspondiente a 20mA.
- Después de una modificación del parámetro P32 verificar el setpoint de humedad de los programas automáticos y manual.

ENTRADAS/SALIDAS

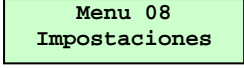
	Apretar el botón <i>menú</i> para seleccionar el menú deseado
 	Utilizar las teclas <i>up</i> y <i>down</i> para visualizar Menu 08 Impostaciones

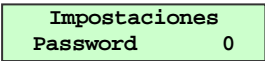
	Presionar la tecla <u>enter</u> para confirmar la elección. Se visualiza 																
	Utilizar las teclas <u>up</u> y <u>down</u> para seleccionar la password “-19”																
	Presionar la tecla <u>enter</u> para confirmar la elección. Se visualiza el primer submenú 																
	Utilizar las teclas <u>up</u> y <u>down</u> para visualizar 																
	Presionar la tecla <u>enter</u> para entrar en la modalidad de visualización ingresos y salidas Se visualiza 																
	Utilizar las teclas <u>up</u> y <u>down</u> para hojear las magnitudes que se desean visualizar  Valor de las temperaturas de cámara y evaporador Valore sonda Humedad Estado de las salidas 1 = relé activado Estado de los ingresos digitales y velocidad del ventilador evaporador <table border="1" data-bbox="1045 900 1444 981"> <tr> <td>C</td> <td>Compresor</td> <td>V</td> <td>Ventilador</td> </tr> <tr> <td>D</td> <td>Defrost</td> <td>H</td> <td>Gen vapor</td> </tr> <tr> <td>EV</td> <td>Luz Deam</td> <td>U</td> <td>Midificador</td> </tr> <tr> <td>R</td> <td>Resistencias</td> <td></td> <td></td> </tr> </table>	C	Compresor	V	Ventilador	D	Defrost	H	Gen vapor	EV	Luz Deam	U	Midificador	R	Resistencias		
C	Compresor	V	Ventilador														
D	Defrost	H	Gen vapor														
EV	Luz Deam	U	Midificador														
R	Resistencias																
	Presionar la tecla <u>menú</u> para volver al Menú Principal																

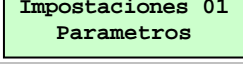
RESTABLECER PARÁMETROS POR DEFAULT

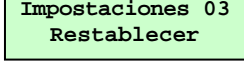
	Apretar el botón <u>menú</u> para seleccionar el menú deseado
	Utilizar las teclas <u>up</u> y <u>down</u> para visualizar 
	Presionar la tecla <u>enter</u> para confirmar la elección. Se visualiza 
	Utilizar las teclas <u>up</u> y <u>down</u> para seleccionar la password “-19”
	Presionar la tecla <u>enter</u> para confirmar la elección. Se visualiza el primer submenú 
	Utilizar las teclas <u>up</u> y <u>down</u> para visualizar 

	Presionar la tecla <u>enter</u> para acceder al pedido de cancelación de los datos registrados en memoria.
Se visualiza	

Pulsar la tecla para salir del menú y no realizar ningún restablecimiento.

Pulsar la tecla para restablecer los parámetros originales por defecto.

Presionar la tecla para volver al Menú Principal.

REGULACIÓN VELOCIDAD VENTILADOR

	Apretar el botón <u>menú</u> para seleccionar el menú deseado
	Utilizar las teclas <u>up</u> y <u>down</u> para visualizar
	Presionar la tecla <u>enter</u> para confirmar la elección.
Se visualiza	
	Utilizar las teclas <u>up</u> y <u>down</u> para seleccionar la password “-19”
	Presionar la tecla <u>enter</u> para confirmar la elección.
Se visualiza el primer submenú	
	Utilizar las teclas <u>up</u> y <u>down</u> para visualizar
	Pulsar la tecla <u>enter</u> para entrar en el modo de regulación de la velocidad del ventilador.
Se visualiza	
	Pulsar la tecla <u>enter</u> para entrar en modificación. El valor parpadea.
Utilizar las teclas y para modificar el valor.	
	Pulsar la tecla <u>enter</u> para confirmar el nuevo valor.
Se visualiza	
Utilizar las teclas y para modificar el valor.	
	Pulsar la tecla <u>enter</u> para confirmar el nuevo valor.
	Presionar la tecla <u>menú</u> para volver al Menú Principal

Están presentes señalizaciones visuales y sonoras en caso de mal funcionamiento.

Sondas Celda

Un problema de la sonda provoca una Alarma de la Sonda Celda, el buzzer suena y sobre el display inicia a parpadear el mensaje de error:

AlarmaSondaCelda

Cualquier ciclo en curso es bloqueado y todas las salidas son desactivadas.

El buzzer se puede cancelar pulsando cualquier tecla.

Al desaparecer el error se retoma el ciclo.

Termostato de seguridad

Cuando la alarma del Termostato es evidenciada desde la tarjeta, el buzzer suena y sobre el display aparece la visualización de alarma:

Alarma termost

Cualquier ciclo en curso es bloqueado y todas las salidas son desactivadas.

El buzzer se puede cancelar pulsando cualquier tecla.

Al desaparecer el error pulsar la tecla  para volver a armar la tarjeta.

Sonda evaporador

Un problema de la sonda provoca una Alarma de problema de la Sonda Evaporador, el buzzer suena y sobre el dispositivo parpadea el mensaje de alarma:

AlarmaSondaEvap

Cualquier ciclo en curso es bloqueado y todas las salidas son desactivadas.

El buzzer se puede cancelar pulsando cualquier tecla.

Al desaparecer el error se retoma el ciclo.

Alta temperatura Evaporador

Cuando la Sonda Evaporador alcanza el valor configurado en el parámetro *P74*, se activa la alarma de alta temperatura del Evaporador. El buzzer suena y sobre el display parpadea el mensaje de alarma:

Alarma AltaTEvap

Cualquier ciclo en curso es bloqueado y todas las salidas son desactivadas.

El buzzer se puede cancelar pulsando cualquier tecla.

Al desaparecer el error pulsar la tecla  para volver a armar la tarjeta.

Sonda Humedad

Un problema de la sonda provoca una Alarma problema de la Sonda Humedad, el buzzer suena y sobre el display parpadea el mensaje de alarmas:

Alarma Sonda Hum

Cualquier ciclo en curso es bloqueado y todas las salidas son desactivadas.

El buzzer se puede cancelar pulsando cualquier tecla.

Al desaparecer el error se retoma el ciclo.

MicroPuerta

Cada apertura de la puerta es señalada con el mensaje Puerta Abierta parpadeante:

Puerta Abierta

La apertura de la puerta durante un ciclo de finalización, frena los Ventiladores, las Resistencias y el Humificador; el Compresor y el Generador de Vapor permanecen encendidos.

El buzzer suena, pero puede cancelarse pulsando cualquier tecla y la señalización vuelve a entrar automáticamente al cierre de la puerta.

Con cada apertura de la Puerta se enciende la Luz.

Malfuncionamiento RTC

En el momento en el que se detecte un malfuncionamiento del RTC, se señala una alarma de RTC; el buzzer suena y sobre el display parpadea el mensaje de alarma:

ALL RTC

Cualquier ciclo en curso es bloqueado y todas las salidas son desactivadas.

El buzzer se puede cancelar pulsando cualquier tecla.

Es posible ir al Menú de configuración del Reloj y aplicar los valores corrientes del RTC; después la tarjeta vuelve a standby.

Alarmas EEPROM

En el momento en el que se detecte incoherencia en los datos memorizados en Eeprom, se señala una alarma de Eeprom; el buzzer suena y sobre el display parpadea el mensaje de alarma:

Alarma EEPROM

Cualquier ciclo en curso es bloqueado y todas las salidas son desactivadas.

El buzzer se puede cancelar pulsando cualquier tecla.

Para volver a instalar la tarjeta pulsar la tecla . Después la instalación de la tarjeta vuelve a standby.

Nota: después de una alarma Eeprom todos los parámetros son restablecidos al valor por defecto.

ANORMALIDADES DE FUNCIONAMIENTO

En el caso de funcionamiento irregular, antes de llamar al servicio asistencia de zona, controlar que:

el interruptor general 1 esté iluminado y que haya tensión de red; (63)

el valor de la temperatura determinada sea el deseado; (65)

las puertas estén perfectamente cerradas;

el equipo no esté cerca de fuentes de calor; (38)

el condensador esté limpio y el ventilador funcione regularmente;

no haya excesiva escarcha sobre la batería evaporante.

En el caso que dichos controles hayan dado resultado negativo, dirijase al servicio de asistencia de su zona suministrando las indicaciones sobre el modelo, número de serie y matrícula indicados en la placa de las características, puesta en la pared interna del aparato.(11)

LIMPIEZA DIARIA

Para garantizar una higiene y una conservación perfectas del compartimiento frigorífico (66) es conveniente efectuar periódicamente y/o diariamente las siguientes operaciones de limpieza indicadas a continuación:

Limpiar cuidadosamente las superficies externas del aparato pasándole con una esponja suave embebida en agua y detergente neutro, y exprimida, únicamente en el sentido del satinado.

El detergente no debe contener cloro y no debe ser abrasivo. (67)

Los detergentes aconsejados son los siguientes tipos:

Detergente desinfectante de acción combinada; (con tensioactivos no iónicos, benzalconio cloruro, sustancias quelantes y pH tampón)

Detergente para laboratorio, neutro, para lavado manual; (con tensioactivos aniónicos y no iónicos)

Desengrasante para ambientes alimenticios; (con tensioactivos aniónicos y EDTA)

Antes del uso diluir eventualmente los detergentes según las instrucciones incluidas en la etiqueta.

Dejar actuar los detergentes al menos 5 minutos.

Enjuagar cuidadosamente las paredes del frigorífico con una esponja pasada varias veces en agua corriente. (69)

Secar con atención utilizando una esponja limpia.

ATENCIÓN: evitar absolutamente el uso de herramientas o elementos que puedan rayar el equipo con la consiguiente formación de herrumbre. (68)

Eliminar eventuales manchas de alimentos o residuos presentes en el interior del aparato (ver párrafo siguiente).

MANCHAS DE ALIMENTOS Y RESIDUOS ENDURECIDOS

En caso de presencia de manchas de comida o residuos en el frigorífico, lavar con agua y quitarlos antes de que estos puedan endurecerse.

Si los residuos ya están endurecidos proceder como indicado a continuación:

Usar una esponja suave humedecida en agua tibia y detergente neutro (se pueden usar esos previstos para la limpieza diaria, a la concentración más alta entre aquellas previstas en la etiqueta). (72)

Humedecer el residuo endurecido de modo tal que se mantenga húmedo por al menos 30 minutos repasando más o menos cada 5 minutos la esponja humedecida en agua y detergente sobre la suciedad endurecida.

Al final del ablandamiento quitar el residuo con la esponja humedecida en agua y detergente neutro.

Si fuera necesario, recurrir a una espátula de madera o a una esponja fina de acero inoxidable, teniendo cuidado de no dañar la superficie del frigorífico. (70)

Al final del procedimiento se aconseja un ciclo de limpieza diaria de todas las superficies internas del frigorífico.

A limpieza terminada enjuagar cuidadosamente con una esponja pasada varias veces en agua corriente.

Secar con atención utilizando una esponja limpia.

También las zonas debajo y cercanas a la aparato deben estar limpias y mantenidas en perfecta higiene. Limpiar con agua y jabón o detergente neutro. (71)

Proteger las chapas con cera con siliconas.

LIMPIEZA Y MANTENIMIENTO PERIÓDICOS

Para obtener un constante rendimiento del aparato es adecuado realizar periódicamente las operaciones de limpieza y mantenimiento.

Antes de iniciar con las mismas, hacer cuanto sigue:

poner el interruptor de línea en la posición OFF. (16)

desenchufar el equipo y esperar a que se haya descongelado completamente. (17)

Con una aspiradora, un pincel o un cepillo no metálico limpiar con cuidado el condensador del grupo refrigerante y el evaporador después de haber quitado las protecciones. (73)

ATENCIÓN: la limpieza y la manutención de la instalación refrigeradora y de la zona compresores requiere la intervención de un técnico especializado y autorizado; por lo tanto no pueden ser efectuadas por personal no preparado. (30)

Limpiar las superficies externas e internas del aparato siguiendo las indicaciones citadas en el párrafo limpieza diaria.

Los frigoríficos con temperatura positiva "TEMPERATURA NORMAL" tienen una descarga en la parte inferior de la celda. Controlar que el orificio de descarga está limpio; de no ser así, limpiarlo. (75)

Después de haber abierto el panel de cierre del kit generador vapores, desmontar el tubo vapores y descalcificarlo utilizando agua corriente. Desmontar el boiler del kit y descalcificarlo utilizando agua corriente. Volver a montar todo. (76a)

A este punto han terminado las operaciones de manutención y limpieza generales.

INTERRUPCIONES EN EL FUNCIONAMIENTO

En caso de prolongada inactividad de la aparato y para mantenerla en las mejores condiciones, seguir estas indicaciones:

llevar el interruptor de red a la posición OFF. (16)

desenchufar el aparato. (17)

vaciar la aparato y limpiarla como indicado en el capítulo "LIMPIEZA". (76)

Vaciar el agua presente en el boiler generador vapores después de haber sacado la abrazadera sujetatubo y sacado el tubo. (76a)

dejar las puertas de las celdas entreabiertas para evitar que tomen mal olor. (77)

cubrir el grupo compresor con un nailon para protegerlo del polvo. (78)

CONSEJOS UTILES PARA LA MANUTENCION DEL ACERO INOXIDABLE

Las aparatos son de acero INOXIDABLE AISI 304. (79)

Para limpieza y manutención de las partes de acero inoxidable, respetar cuanto se especifica a continuación, teniendo presente que la regla primera y fundamental es garantizar la toxicidad y la máxima higiene de los productos tratados.

El acero inoxidable tiene una capa fina de óxido que impide la formación de herrumbre.

Existen sustancias o detergentes que pueden destruir o dañar esta capa y comenzar así un proceso de corrosión.

Antes de usar cualquier producto detergente, preguntar al proveedor de confianza cuál es el tipo más adecuado de detergente neutro que no provoca corrosiones al acero. (73)

En caso de rayones en las superficies, es necesario pulir con lana de ACERO INOXIDABLE finísima o esponjas abrasivas de material sintético fibroso frotando en el sentido del satinado. (81)

ATENCIÓN: para limpiar el ACERO INOXIDABLE no deben usarse esponjitas de hierro y ni siquiera dejarlas apoyadas en las superficies pues los depósitos ferrosos pueden pegarse y provocar la formación de herrumbre por contaminación, comprometiendo el estado de higiene. (81)

PROBLEMAS DE FUNCIONAMIENTO

A denudo, las dificultades de funcionamiento que se presentan, son ocasionadas por causas banales, que se pueden solucionar sin la intervención de un técnico especializado, por tanto, antes de llamar la red de asistencia por una avería, controlar lo siguiente:

PROBLEMA	CAUSAS POSIBLES
El aparato no se enciende	Controlar que esté enchufado correctamente
	Controlar que a la toma llegue corriente
La temperatura interna es demasiado elevada	Verificar la regulación de la tarjeta electrónica
	Verificar que no haya una fuente de calor cercana
	Verificar que la puerta cierre correctamente
El aparato es excesivamente ruidoso	Verificar la nivelación del mismo. Una posición no equilibrada podría originar vibraciones
	Controlar que el aparato no esté en contacto con otros aparatos o partes que podrían entrar en resonancia
En el interior del frigorífico hay olores desagradables	Hay alimentos con olor muy fuerte (por ejemplo queso y melón), en recipientes no herméticos
	Las superficies internas deben limpiarse
Sobre el aparato se forma condensación	La humedad ambiente es muy elevada
	No se han cerrado bien las puertas

Realizar las verificaciones arriba indicadas, si el desperfecto continúa, dirigirse a la asistencia técnica, recordando de señalar:

- la naturaleza del defecto

- el modelo y el número de matrícula del aparato que se pueden observar en la placa de las características eléctricas, puesta bajo la pared interna del aparato.

DESPACHO DE RESIDUOS Y DEMOLICION

ALMACENAJE DE LOS DESHECHOS

Al final del ciclo de vida del producto, no eliminar en el medio ambiente el aparato. Las puertas tendrán que desmontarse antes de la eliminación del aparato. Está admitido u almacenaje provvisorio de los deshechos especiales, en vista de una eliminación, por medio del tratamiento y/o almacenaje definitivo.

De todos modos se deben cumplir con las leyes vigentes en cuanto a la tutela del ambiente, en el país del utilizador.

PROCEDIMENTOS RELATIVOS A LAS MACRO-OPERACIONES DE DESARMADO DEL APARATO

Cada País tiene legislaciones diferentes, por tanto, se tienen que cumplir las prescripciones impuestas por las leyes y entidades encargadas de los Países donde se realiza la demolición.

En general, es necesario devolver el frigorífico a los centros especializados para el retiro/demolición. Desmontar el frigorífico, agrupando los componentes de acuerdo a su naturaleza química, recordando que en el compresor hay aceite lubricador y fluido refrigerante, que se pueden recuperar y volver a usar, y que los componentes del frigorífico son deshechos especiales asimilables a los urbanos. Hacer que el aparato sea inutilizable para su eliminación, sacando el cable de alimentación y cualquier dispositivo de cierre espacios, con el fin de evitar que alguien pueda quedar encerrado en el interior.

LAS OPERACIONES DE DESARMADO, DE TODOS MODOS, TIENE QUE SER REALIZADA POR PERSONAL ESPECIALIZADO.

ELIMINACIÓN SEGURA DE LOS RESIDUOS DE APARATOS ELÉCTRICOS Y ELECTRÓNICOS (DIRECTIVA RAEE 2002/96/CE)

No abandonar material contaminante en el ambiente. Efectuar su eliminación en conformidad con lo dispuesto por las leyes vigentes en esta materia.

Conforme con la Directiva RAEE 2002/96/CE (sobre residuos de aparatos eléctricos y electrónicos), al efectuar la eliminación de los equipos el usuario deberá entregarlos en instalaciones de recogida específicas y autorizadas, o bien -en el momento de efectuar una nueva compra- deberá entregarlos aún montados al distribuidor.

Todos los aparatos que deben ser eliminados de modo selectivo y en conformidad con lo dispuesto por la Directiva RAEE 2002/96/CE, aparecen identificados mediante un símbolo específico (12)

LA ELIMINACIÓN ABUSIVA DE RESIDUOS DE APARATOS ELÉCTRICOS Y ELECTRÓNICOS SERÁ SANCIONADA EN CONFORMIDAD CON LO DISPUESTO POR LAS LEYES VIGENTES EN EL TERRITORIO EN QUE SE HA COMETIDO LA INFRACCIÓN.

INVERSIÓN PUERTA (82)

Los armarios frigoríficos con una puerta se entregan, generalmente, con abertura hacia la derecha. En la transformación con bisagra izquierda se tendrá que actuar de la manera siguiente:

- Girar el cuadro sobre las cabeceras laterales quitando el tornillo de bloqueo "F".
- Desatornille los dos tornillos de fijación del estribo "A" y el tornillo "bloqueo" bisagra "B".
- Quite la puerta y desmonte la bisagra "B" y el elemento "E", invirtiendo el montaje.
- Desmonte el estribo inferior "D" volviendolo a montar del lado opuesto en la sede.
- Coloque la puerta introduciendo el orificio del elemento inferior "E" en el perno del estribo "D".
- Fije el estribo "A" a la estructura en el lado opuesto, ajustando completamente los tornillos de fijación.
- Antes del ajustado de los tornillos de los estribos, controle la altura de abisagrado que tiene que ser de 12mm aproximadamente y la perpendicularidad de la puerta en relación a la estructura.
- Desplazar el micro presente sobre el panel de mandos hacia la parte opuesta, utilizando los orificios predispuestos.
- Montar nuevamente el cuadro.

NOTA : las tareas de desmontaje y remontaje se deben realizar con la puerta cerrada.

FICHA TÉCNICA DEL REFRIGERANTE

R404a: componentes del fluido

Trifluoroetano	(HFC 143a)	52%
Pentafluoroetano	(HFC 125)	44%
Tetrafluoroetano	(HFC 134a)	4%

GWP = 3750
ODP = 0

Identificación de peligros

Fuertes exposiciones por inhalación pueden producir efectos anestésicos. Las fuertes exposiciones pueden producir anomalías del ritmo cardiaco y ocasionar una muerte repentina. El producto atomizado, salpicado o rociando puede producir ustiones por congelación en los ojos o la piel.

Medidas de primer auxilio

• Inhalación:

alejar el accidentado de exposición al producto y mantenerlo en el calor y en estado de reposo. Si es necesario, darle oxígeno. Practicarle la respiración artificial si la respiración natural se ha parado o amenaza con hacerlo. En caso de paro cardiaco practicarle un masaje cardiaco externo. Solicitar asistencia médica inmediata.

• Contacto con la piel:

echar agua a las zonas golpeadas para que descongelen. Quitar los vestidos contaminados.

ATENCIÓN: los vestidos pueden adherirse a la piel en caso de ustiones por congelación.

En caso de contacto con la piel lavarla inmediata y abundantemente con agua tibia. Tras producirse algún sintoma (irritación o formación de ampollas) solicitar asistencia médica.

• Contacto con los ojos:

lavarlos inmediatamente con solución para lavado ocular o agua limpia manteniendo abiertos los párpados, por al menos 10 minutos. Solicitar asistencia médica.

• Ingestión:

puede provocar vómito. Si el accidentado está consciente, hacer que se enjague la boca y beda unos 200-300 ml de agua. Solicitar asistencia médica inmediata.

• Tratamientos médicos ulteriores:

tratamiento sintomático y terapia de sostén, si necesarios. No dar al accidentado adrenalina o medicamentos simpaticomiméticos similares por el riesgo de arritmia cardiaca con posible paro cardiaco.

Informaciones ecológicas

Persistencia y degradación:

• HFC 143a:

se descompone lentamente en la atmósfera inferior (troposfera). Su duración en la atmósfera es de 55 años.

• HFC 125:

se descompone lentamente en la atmósfera inferior (troposfera). Su duración en la atmósfera es de 40 años.

• HFC 134a:

se descompone con cierta rapidez en la atmósfera inferior (troposfera). Su duración en la atmósfera es de 15,6 años.

• HFCs 134a, 125, 134a:

no influyen en la polución fotoquímica (es decir, no están comprendidos entre los componentes orgánicos volátiles - VOC – según cuanto establecido en el acuerdo UNECE). No producen rarefacción del ozono.

Los residuos de producto dispersados en la atmósfera no producen contaminación de las aguas a largo plazo.

EL ESQUEMA ELÉCTRICO ESTÀ COLOCADO EN LA ULTIMA PÀGINA DE EL MANUAL DE INSTRUCCION

POS	DESCRIPTION	POS	DESCRIPTION
1	GRUPO COMPRESOR	44	RELAIS COMPRESOR
2	VENTILADOR CONDENSADOR	44A	RELAIS PTC
3	TABLERO GENERAL DE BORNES	44B	RELAIS MICROINTERRUPTOR MAGNETICO
6	INTERRUPTOR GENERAL CON INDICADOR	56	FILTRO
8	TOMA ELÉCTRICA	69	CAJA DE TERMINALE DE PISO
9	VENTILADOR EVAPORADOR	70	PRESOSTATO DE SEGURIDAD DE ALTA PRESIÓN
9A	VENTILADOR EVAPORADOR	75	ELÉCTROVALVULA
9B	VENTILADOR EVAPORADOR	76	MICROINTERRUPTOR MAGNETICO
10	LAMPARA ILLUMINACIÓN INTERIOR	85	CAJA DE DISTRIBUCION
10A	LAMPARA ILLUMINACIÓN INTERIOR	86	SONDA CONDENSADOR
12	ELECTROVALVULA DISPOSIT.DESCONG.	90	TERMORREGULADOR DIGITAL
14	REGULADOR HUMEDAD CON INDICADOR	91	RESISTENCIA PTC
15	MICRO INTERRUPTOR VENTILADOR	96	TARJETA ELECTRÓNICA
15A	MICRO INTERRUPTOR VENTILADOR	101	RESISTENCIA TAMPON
18	INDICADOR DEL TERMOSTATO DE SEGURIDAD	102	TERMOSTATO BIMETALICO DE SEGURIDAD
19	TERMOSTATO DE SEGURIDAD	103	SONDA DE HUMEDAD
20	RESISTENCIA ANTICONDENSACION PUERTAS	104	REGULADORES DE NIVEL
20A	RESISTENCIA ANTICONDENSACION PUERTAS	105	SONDA DE NIVEL
21	RESISTENCIA DESPOSIT. DESCONG.	106	TERMOSTATO DE SEGURIDAD GENERADOR DE VAPOR
22	RESISTENCIA FONDO BANDEJAS	107	RESISTENCIA ELECTRICA CAMARA
25	TRASFORMADOR	108	RESISTENCIA GENERADOR DE VAPOR
28	INTERRUPTOR ILLUMINACIÓN INTERIOR	109	TARJETA CUADRO INTERRUMPE FERMENTACIÓN
29	REACTOR LAMPARAS TL	110	TARJETA COMANDOS INTERRUMPE FERMENTACIÓN
30	STARTER	111	TARJETA EXPANSION RELE' INTERRUMPE FERMENTACION
31	LAMPARA TL	112	ELECTROVALVULA AGUA HUMIDIFICACION

INDEX

BESCHRIJVING APPARAAT	2
ACCESSOIRES	2
IDENTIFIKATIE ETIKET	2
ALGEMENE OPMERKINGEN BIJ DE LEVERING	3
VEILIGHEIDSVOORSCHRIFTEN	3
HACCP VOORSCHRIFTEN	4
TECHNISCHE KENMERKEN	4
IN WERKING STELLEN EN INSTALLATIE	4
BEDIENINGSPANELEN	6
AANSLUITING	7
INLEGGEN VAN PRODUCTEN	7
WERKING <small>HANDMATIGE CYCLUS– AUTOMATISCHE CYCLUS</small>	7
UITZETTEN	12
ONTDOOIEN	13
KLOK INSTELLEN	13
ZOMERTIJD INSTELLEN	13
TAAL	14
PROGRAMMERING	14
ALARMSIGNALLEN	20
ONREGELMATIGHEDEN IN DE WERKING	21
DAGELIJKSE REINIGING	21
VOEDSELVLEKKEN EN HARD GEWORDEN RESTEN	22
REGELMATIG SCHOONMAAK EN ONDERHOUD	22
ONDERBREKING VAN HET GEBRUIK	23
NUTTIGE TIPS VOOR HET ONDERHOUD VAN ROESTVRIJ STAAL	23
STORINGEN IN DE WERKING	23
HET AFVALMATERIAAL LOZEN EN HET APPARAAT AFDANKE	24
DEUR OMKEREN	25
SPECIFICATIES VAN DE KOELVLOEISTOF	25

BESCHRIJVING APPARAAT

Deze apparatuur is ontworpen voor koeling, verwarming en conservering van voedingsmiddelen. Elk ader gebruik moet als oneigenlijk beschouwd worden.

LEP OP: de apparaten zijn niet geschikt om buiten geïnstalleerd te worden of op plaatsen die aan de inwerking van weersinvloeden blootgesteld zijn.

De fabrikant kan op geen enkele wijze aansprakelijk gesteld worden voor onjuist gebruik van de producten.

De apparaten zijn beschikbaar met deuren in staal.

De apparaten zijn gerealiseerd met koelinstallaties op "NORMALE TEMPERATUUR" en op "LAGE TEMPERATUUR" teneinde te voldoen aan de conservering van voedingsmiddelen op verschillende temperatuur. (1)

De apparaten zijn voorzien van een verdamper met kleppen beschermd tegen oxydatie, een hermetische compressor, een condensator in koper-aluminium, een bevochtigingskit, een interne weerstand, een vochtigheidssonde en een gerelateerd bedieningspaneel. (2)

De apparaten zijn uitgerust met een bedieningspaneel, onderscheiden door het soort instellingen afhankelijk van de typologie van het apparaat (POSITIEVE TEMPERATUUR, LAGE TEMPERATUUR). (3)

De compressors bevinden zich in het bovengedeelte van de kasten om gebruik te maken van een goede ventilatie en verspreiding van de warmte. (4)

De apparaten zijn voorzien van een afvoerbak, uitgerust met een automatische verdampingsinrichting van de condens, geplaatst op de buitenachterzijde van het apparaat. (5)

Geen enkele koelkast is voorzien van een opvangbak voor de condens.

De apparaten zijn uitgerust met twee verschillende verlichtingssystemen in de functie van het model. De interne lampen zijn beschermd teneinde het contact met de voedingsmiddelen te vermijden en tegen schokken waardoor ze kapot zouden kunnen gaan. (8)

De deuren van de apparaten hebben een slot met sleutel om een goede sluiting te kunnen garanderen. (9)

De gedeelten die met de levensmiddelen in aanraking komen zijn gemaakt van staal of bekleed met kunststof materiaal dat niet giftig is. (10)

Bij de koelunits wordt de door de huidige wetgeving toegestane koelvloeistof toegepast, van het type HFK.

ACCESSOIRES

Zie figuur 7.

IDENTIFIKATIE ETIKET

Voor meer informatie kunt U de fabrikant bellen. Het MODEL en SERIENUMMER, vermeldt in de tabel met technische gegevens die zich onder het instrumentenbord bevindt, steeds vermelden (11).

Inhoud velden technisch plaatje (12)

- | | |
|-----------------------------------|--------------------------------------|
| 1) MODEL | E) TOTALE KRACHT VERLICHTING |
| 2) NAAM EN ADRES VAN FABRIKANT | F) ZEKERINGSSTROOM |
| 3) EG HERKENNINGSTEKEN | G) TYPE KOELGAS |
| 4) BOUWJAAR | H) HOEVEELHEID KOELGAS |
| 5) REGISTRATIENUMMER | L) TEMPERATUURKLASSE KOELINSTALLATIE |
| 6) KLASSE ELEKTRISCHE ISOLATIE | M) MAXIMUM WATERDRUK |
| 7) KLASSE ELEKTRISCHE BESCHERMING | N) WATERTEMPERATUUR |
| A) SPANNING ELEKTRISCHE VOEDING | O) WATERVERBRUIK |
| B) INTENSITEIT ELEKTRISCHE STROOM | P) MINIMUM WATERDRUK |
| C) FREKWENTIE | R) AEEA SYMBOOL |
| D) NOMINALE KRACHT | W) KRACHT WARMTE-ELEMENTEN |

ALGEMENE OPMERKINGEN BIJ DE LEVERING

Kontroleren bij de levering dat de verpakking intact is en geen schade heeft opgelopen gedurende het transport. (13)

Na het apparaat uitgepakt te hebben kontroleren of alle onderdelen aanwezig zijn en of de kenmerken voldoen aan hetgeen u besteld heeft. Mocht dit niet het geval zijn, gelieve onmiddellijk contact op te nemen met de verkoper. (14)

Wij feliciteren U met uw uitstekende keuze en hopen op een optimaal gebruik van de koelkasten volgens de aanwijzingen en nodige voorzorgen vermeldt in deze gebruiksaanwijzing. (15)

NB: nadruk van de gebruiksaanwijzing verboden.

Dankzij constant onderzoek en verbetering van de technologische kwaliteit kunnen de technische gegevens hier vermeld zonder voorafgaand bericht gewijzigd worden.

VEILIGHEIDSVOORSCHRIFTEN

OPGELET: bij iedere handeling van reiniging en onderhoud dient de stroom uitgeschakeld te worden:

zet de schakelaar aanwezig op het instrumentenbord op de stand OFF (16a)

de hoofdschakelaar op OFF zetten. (16b)

de stekker uit het stopkontakt trekken (17)

OPGELET: geen niet-geaarde stekkers of stopkontakten gebruiken. (18)

Het netstopkontakt moet geaard zijn. (19)

OPGELET: geen adapters of verlengsnoeren gebruiken voor aansluiting aan het net. (20)

OPGELET: het is nodig te wachten tot de ingestelde temperatuur bereikt is, alvorens etenswaren in het apparaat te zetten. (21)

Etenswaren moeten altijd op de juiste manier verpakt zijn alvorens ze in het apparaat worden gezet. (22)

OPGELET: geen warme dranken of etenswaren in het apparaat zetten. (23)

OPGELET: Zorg ervoor dat bij het opslaan van etenswaren deze niet onder de roosters uitkomen en dat ze de luchtstroom niet blokkeren. De ruimte waar de ventilatoren opzuigen niet blokkeren. (24)

OPGELET: Niet schoonmaken in de buurt van het apparaat als de deur geopend is. (25)

Het apparaat niet met plenzen water of water onder hoge druk schoonmaken. (26)

OPGELET: geen substanties gebruiken bij de reiniging of in de buurt van het apparaat die chloor bevatten (bleekmiddel, zoutzuur, enz.) of die giftig zijn. (27)

OPGELET: blokkeer niet het bovengedeelte van het apparaat noch de luchtstromen, terwijl het apparaat in gebruik is of onder stroom staat. (28)

OPGELET: geen voorwerpen op de bodem van de koelkast plaatsen. De daarvoor bestemde roosters gebruiken. (29)

Het over de roosters verdeelde maximum gewicht kan 48 kg bedragen.

De reiniging en het onderhoud van het koelsysteem en van de kompressorruimte moet door een gespecialiseerd technicus gebeuren, en kan daarom niet door ongeschikt personeel worden uitgevoerd. (30)

Tijdens handelingen van onderhoud of in het geval van onregelmatigheden, het apparaat geheel uitzetten; Vraag om tussenkomst van de REPARATIEDIENST van een daartoe bevoegd centrum en het gebruik van originele reserveonderdelen. (31) Gebeurt dit niet, dan kan dit de veiligheid van het apparaat in gevaar brengen.

HACCP VOORSCHRIFTEN

OPGELET: Producten die snel bederven als laatste uit de koelkast nemen, zodat deze slechts voor korte tijd aan de omgevingstemperatuur blootgesteld worden.

OPGELET: Reeds ontdooide producten niet opnieuw invriezen.

OPGELET: Instrumenten nummeren en tweemaal daags de temperatuur kontoleren. De waarden op het daarvoor bestemde formulier invullen en 24 maanden bewaren.

OPGELET: Een digitale klok registreert eventuele stroomonderbrekingen, zodat beschadigde levensmiddelen verwijderd kunnen worden.

Maximaal toegestane temperatuur levensmiddelen

LEVENS MIDDEL	NORMALE OPSLAGTEMPERATUUR (°C)	MAXIMALE TEMPERATUUR TIJDENS HET TRANSPORT (°C)
Verse gepasteuriseerde melk	0÷+4	9
Verse room	0÷+4	9
Yoghurt, ricotta, verse kaas	0÷+2	9
Gekoelde visproducten	0÷+2	0÷+4

TECHNISCHE KENMERKEN

De technische gegevens kunt U vinden op the laatste pagina van de gebruiksaanwijzing. (32)

IN WERKING STELLEN EN INSTALLATIE

De apparaten worden altijd ingepakt en op palets verzonden. (33)

Bij ontvangst en na het apparaat uitgepakt te hebben, gelieve zich te gedragen in geval van schade of ontbrekende delen, zoals beschreven in het hoofdstuk "ALGEMENE OPMERKINGEN BIJ DE LEVERING".

Het in werking stellen en de installatie moet door gespecialiseerd personeel uitgevoerd worden. (30)

De verpakkingendoos verwijderen waarbij opgepast moet worden niet de oppervlakken van het apparaat te deuken. (34)

OPGELET: de verpakkingsonderdelen (plastic zakken, schuimrubber, spijkers e.d.) moeten buiten het bereik van kleine kinderen worden gehouden, omdat zij gevaarlijk kunnen zijn.

Het apparaat dient door een kar met vork opgeheven te worden en op de installatieplaats gebracht te worden, waarbij opgelet moet worden dat het apparaat in evenwicht is. (35)

OPGELET: Het apparaat mag nooit in horizontale positie vervoerd worden; dit kan structurele schade veroorzaken. (36)

OPGELET: Zowel voor het plaatsen van het apparaat op de plek van installatie als voor toekomstige verplaatsingen, mag deze nooit geduwd of geschoven worden, om te voorkomen dat deze valt of op dat op deze manier schade wordt toegebracht aan delen van het apparaat. (37)

OPGELET: Het apparaat niet in de buurt van een warmtebron plaatsen of in een omgeving met hoge temperatuur, dit zou een mindere werking en een hoger verbruik veroorzaken. (38)

OPGELET: Tussen de bovenwand en het plafond moet er minstens 50cm vrij zijn. Het apparaat kan naast andere apparaten gezet worden, maar als er condensaatvorming mogelijk is, moet er een minimale tussenafstand van 2cm gerespecteerd worden.

De beschermlaag van het produkt wegnemen. Deze handeling kan vervelende, doch ongevaarlijke schokken veroorzaken (statische elektriciteit). Dit kan verminderd worden als men met n hand steeds in contact met het apparaat blijft of als met het buitenste omhulsel met de grond in contact houdt. (39)

Na het apparaat op de juiste plaats te hebben gezet, de palet wegnemen met behulp van een hamer en beitel, opletend niet de pootjes binnenin de blokken of het apparaat te beschadigen. (40)

Het houten steunblok wegnemen. (41)

De sifon afvoerbuis aanwezig onder het apparaat moet rechtstreeks zijn aangesloten op de riolering met open afvoer. (41a)

De buis voor de watertoevoer (aansluiting 3/4") aanwezig in het bovenste gedeelte van het apparaat moet zijn aangesloten op het waternet middels een tegenhoudklep, een patroonfilter en een klep van geen terugkeer. (41b)

De temperatuur van het water van toevoer moet tussen 5°C en 40°C zijn.

De waterdruk moet voldoende zijn om een goede werking van het apparaat te garanderen (>1bar).

Indien het gebruikte water bijzonder onzuiver is, is het aan te raden filters of zuiveringsinstallaties te gebruiken die geschikt zijn om het water te behandelen.

Nu kunnen de pootjes vastgezet worden. (42)

De koelkast kantelen en nivelleren zodat de koelkastdeur/-en zich automatisch sluit/-en. (43)

Het apparaat met lauw water en een neutraal schoonmaakmiddel reinigen (zoals beschreven in het hoofdstuk "REINIGING") en de accessoires aanbrengen.

Het apparaat is voorzien van een stekker SHUKO. Controleren of deze voldoet aan de normen EN60320 en aan de nationale normen. Eventueel de stekker vervangen indien deze niet voldoet. (44)

OPGELET: Deze handeling moet door een gespecialiseerd technicus worden verricht. (30)

Kontroleren of de netspanning gelijk is aan die op het plaatje met de technische kenmerken van het apparaat is aangegeven. (45)

De stekker in het stopkontakt stoppen. (46)

De handelingen van het in werking stellen zijn nu beëindigd.

Het apparaat moet in een equipotentiaal systeem worden ingebracht, waarvan de efficiëntie is vastgesteld volgens de van kracht zijnde normen.

De aansluiting vindt plaats d.m.v. een schroef die gekonmerkt is met het teken "equipotentiaal" en die zich in de dompressorruimte bevindt. (47)

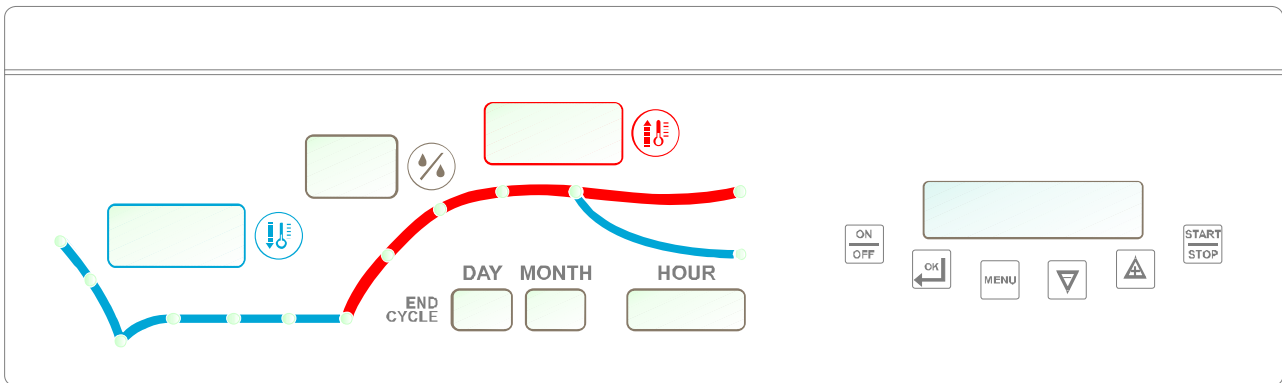

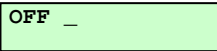
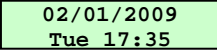
	<p><u>ON/OFF-toets</u> Indien u de toets gedurende 5 sec indrukt gaat het controlelampje uit en op het display verschijnt </p> <p>Door vervolgens op de toets te drukken gaat de controleinstallatie aan en wordt getoond </p>
	<p><u>Enter-toets</u> Hiermee heeft u toegang tot een menu of kunt u een parameter selecteren.</p> <p><i>Tijdens een cyclus maakt de druk op de toets de weergave van datum en tijd mogelijk.</i></p>
	<p><u>Menu-toets</u> Hiermee kunt u naar het hoofdmenu gaan of terugkeren naar het voorgaande menu.</p>
	<p><u>Up en Down-toetsen</u> Hiermee kunt u door de verschillende menu's bladeren of de waarden van de parameters aanpassen.</p>
	<p><u>Start/Stop-toets</u> Maakt het mogelijk om een cyclus op te starten/te onderbreken.</p> <p><i>Bij apparaat in ruststand, door 3 sec. op de toets te drukken wordt automatisch het programma weergegeven voor de dag van de week waar de activering op plaatsvindt.</i></p>
	<p>Toont de temperatuur in de cel gedurende fase van koeling, conservering of remrijzen.</p>
	<p>Toont het vochtigheidspercentage in de cel. <i>Brandt tijdens de fases waarin de controle van de vochtigheid voorzien is.</i></p>
	<p>Toont de temperatuur in de cel gedurende de fase van opwarming, klimatisering, vertraging of stimulering van het rijzen.</p>
	<p>Geven datum en tijd aan. <i>Geven de dag, maand en reële tijd weer met de kaart in standby of tijdens de handmatige cyclus.</i> <i>Geven de dag, maand en tijd weer voor het einde van de cyclus tijdens de automatische cyclus.</i></p>

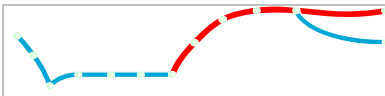

Toont de vorderingsstatus van de geselecteerde cyclus.
De led behorende bij de eerder beëindigde fases blijven tijdens het uitvoeren van de volgende fases branden.

De systeemkaart voorziet in de mogelijkheid **automatische** cyclussen in te stellen of een **handmatige** cyclus uit te voeren.

Handmatige cyclus: instelling van de drie fasen:
KOELING, VERWARMING EN KLIMATISERING

Automatische cyclussen: (7 ingestelde en of aanpasbare cyclussen) bestaande uit de volgende fasen:
REMRIJZEN, CONSERVEREN, STIMULEREN, RIJZEN EN VERTRAGEN

AANSLUITING

Om het apparaat op te starten, de volgende handelingen uitvoeren:

- de stekker in het stopcontact stoppen; (50)
- de netschakelaar op stand ON zetten; (51)
- druk op de  -toets;

Bij inschakeling gaat de systeemkaart na een zelfcontrole in standby.

Op het display wordt getoond

02/01/2009
Tue 17:35

INLEGGEN VAN PRODUCTEN

Pas nu en niet eerder, kan men etenswaren in het apparaat zetten.



- Leg de producten gelijkmatig verspreid in de unit om de luchtcirculatie te bevorderen.
- In de unit treft u stickers aan waar de laadlimiet van de roosters op staat vermeld.
- Laat de deur niet langer open staan dan nodig is om de levensmiddelen uit het apparaat te pakken of in het apparaat te leggen.
- Geadviseerd wordt om de sleutels buiten het bereik van kinderen te houden.

WERKING









HANDMATIGE CYCLUS

De handmatige cyclus bestaat uit 3 onafhankelijke fasen en de overgang van een fase naar een andere is **niet automatisch**.







KOELINGSFASE

	Druk op de toets <u>menu</u> om het gewenste menu te kiezen
	Gebruik de toetsen <u>up</u> en <u>down</u> teneinde te visualiseren
	Druk op de toets <u>enter</u> om de keuze te bevestigen









Menu 01
Manual

 	Gebruik de toetsen <u>up</u> en <u>down</u> teneinde te visualiseren	Manual Refrigeration
	Druk op de toets <u>enter</u> om de keuze te bevestigen.	Refrigeration T=25°C
	Druk op de toets <u>enter</u> om de modaliteit voor het wijzigen van de SetPoint te betreden. <i>De SetPoint waarde van de Temperatuur knippert, maak gebruik van de toetsen  en  om de waarde te wijzigen</i>	
	Druk op de toets <u>enter</u> om de nieuwe waarde te bevestigen	
	Druk op de toets <u>start/stop</u> om onmiddellijk de gekozen fase te activeren.	Manual 13:39 T=5°C

VERWARMINGSFASE

	Druk op de toets <u>menù</u> om het gewenste menu te kiezen	
 	Gebruik de toetsen <u>up</u> en <u>down</u> teneinde te visualiseren	Menu 01 Manual
	Druk op de toets <u>enter</u> om de keuze te bevestigen	
 	Gebruik de toetsen <u>up</u> en <u>down</u> teneinde te visualiseren	Manual Heating
	Druk op de toets <u>enter</u> om de keuze te bevestigen.	Heating T=25°C UR=80%
	Druk op de toets <u>enter</u> om de modaliteit voor het wijzigen van de SetPoint te betreden. <i>De SetPoint waarde van de Temperatuur knippert, maak gebruik van de toetsen  en  om de waarde te wijzigen</i>	
	Druk op de toets <u>enter</u> om de nieuwe waarde te bevestigen. <i>De SetPoint waarde voor de Vochtigheid knippert, maak gebruik van de toetsen  en  om de waarde te wijzigen</i>	
	Druk op de toets <u>enter</u> om de nieuwe waarde te bevestigen	
	Druk op de toets <u>start/stop</u> om onmiddellijk de gekozen fase te activeren.	Manual 13:39 T=5°C %rH=63%

KLIMATISERINGSFASE

	Druk op de toets <u>menù</u> om het gewenste menu te kiezen
	Gebruik de toetsen <u>up</u> en <u>down</u> teneinde te visualiseren Menu 01 Manual
	Druk op de toets <u>enter</u> om de keuze te bevestigen
	Gebruik de toetsen <u>up</u> en <u>down</u> teneinde te visualiseren Manual Air Con
	Druk op de toets <u>enter</u> om de keuze te bevestigen. Wordt getoond Air Con T=25°C UR=80%
	Druk op de toets <u>enter</u> om de modaliteit voor het wijzigen van de SetPoint te betreden. <i>De SetPoint waarde van de Temperatuur knippert, maak gebruik van de toetsen  en  om de waarde te wijzigen</i>
	Druk op de toets <u>enter</u> om de nieuwe waarde te bevestigen. <i>De SetPoint waarde voor de Vochtigheid knippert, maak gebruik van de toetsen  en  om de waarde te wijzigen</i>
	Druk op de toets <u>enter</u> om de nieuwe waarde te bevestigen
	Druk op de toets <u>start/stop</u> om onmiddellijk de gekozen fase te activeren. Wordt getoond Manual 13:39 T=5°C %rH=63%

AUTOMATISCHE CYCLUS

De elektronische systeemkaart heeft 7 automatische cyclussen gememoriseerd als volgt.

APPARATEN -5°C / +30°C

CYCLUS		P1	P2	P3	P4	P5	P6	P7
		Maandag	Dinsdag	Woensdag	Donderdag	Vrijdag	Zaterdag	Zondag
BLOKKERING	Duur	02:00	02:00	02:00	02:00	02:00	02:00	02:00
	Temperatuur	-5°C	-5°C	-5°C	-5°C	-5°C	-5°C	-5°C
CONSERVERING	Temperatuur	-1°C	-1°C	-1°C	-1°C	-1°C	-1°C	-1°C
ACTIVERING	Duur	02:00	02:00	02:00	02:00	02:00	02:00	02:00
	Temperatuur	20°C	20°C	20°C	20°C	20°C	20°C	20°C
	Vochtigheid	70%	70%	70%	70%	70%	70%	70%
RIJZEN	Duur	02:00	02:00	02:00	02:00	02:00	02:00	02:00
	Temperatuur	28°C	28°C	28°C	28°C	28°C	28°C	28°C
	Vochtigheid	80%	80%	80%	80%	80%	80%	80%
EINDE PROGRAMMA	Tijd	01:00	01:00	01:00	01:00	01:00	01:00	01:00
BLOKKERING	Temperatuur	6°C	6°C	6°C	6°C	6°C	6°C	6°C
	Vochtigheid	80%	80%	80%	80%	80%	80%	80%

APPARATEN -18°C / +30°C

CICLO		P1	P2	P3	P4	P5	P6	P7
		Lunedì	Martedì	Mercoledì	Giovedì	Venerdì	Sabato	Domenica
BLOCCO	Durata	02:00	02:00	02:00	02:00	02:00	02:00	02:00
	Temperatura	-20°C	-20°C	-20°C	-20°C	-20°C	-20°C	-20°C
CONSERVAZIONE	Temperatura	-1°C	-1°C	-1°C	-1°C	-1°C	-1°C	-1°C
RISVEGLIO	Durata	02:00	02:00	02:00	02:00	02:00	02:00	02:00
	Temperatura	20°C	20°C	20°C	20°C	20°C	20°C	20°C
	Umidità	70%	70%	70%	70%	70%	70%	70%
LIEVITAZIONE	Durata	02:00	02:00	02:00	02:00	02:00	02:00	02:00
	Temperatura	28°C	28°C	28°C	28°C	28°C	28°C	28°C
	Umidità	80%	80%	80%	80%	80%	80%	80%
FINE PROGRAMMA	Ora	01:00	01:00	01:00	01:00	01:00	01:00	01:00
BLOCCO	Temperatura	6°C	6°C	6°C	6°C	6°C	6°C	6°C
	Umidità	80%	80%	80%	80%	80%	80%	80%







APPARATEN -2°C / +30°C

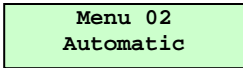

CYCLUS		P1	P2	P3	P4	P5	P6	P7
		Maandag	Dinsdag	Woensdag	Donderdag	Vrijdag	Zaterdag	Zondag
BLOKKERING	Duur	02:00	02:00	02:00	02:00	02:00	02:00	02:00
	Temperatuur	-2°C	-2°C	-2°C	-2°C	-2°C	-2°C	-2°C
CONSERVERING	Temperatuur	+2°C	+2°C	+2°C	+2°C	+2°C	+2°C	+2°C
ACTIVERING	Duur	02:00	02:00	02:00	02:00	02:00	02:00	02:00
	Temperatuur	20°C	20°C	20°C	20°C	20°C	20°C	20°C
	Vochtigheid	70%	70%	70%	70%	70%	70%	70%
RIJZEN	Duur	02:00	02:00	02:00	02:00	02:00	02:00	02:00
	Temperatuur	28°C	28°C	28°C	28°C	28°C	28°C	28°C
	Vochtigheid	80%	80%	80%	80%	80%	80%	80%
EINDE PROGRAMMA	Tijd	01:00	01:00	01:00	01:00	01:00	01:00	01:00
BLOKKERING	Temperatuur	6°C	6°C	6°C	6°C	6°C	6°C	6°C
	Vochtigheid	80%	80%	80%	80%	80%	80%	80%

*N.B.: Maximum temperatuur deeg 27°C – bloem vxx 320 – vermeerderen 0,01 | gist- vermeerderen 0,01 zout voor hartige producten of suiker voor zoete producten

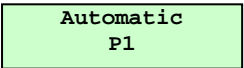
Elke automatische cyclus bestaat uit 5 fasen.

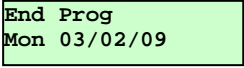











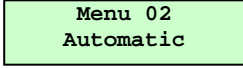

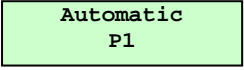









De cyclus start altijd van de fase REMRIJZEN en de overgang naar de achtereenvolgende fasen geschiedt **automatisch** op basis van de duur van elke afzonderlijke fase en van de dag en het tijdstip waarop de ingestelde cyclus eindigt.

	Druk op de toets <u>menù</u> om het gewenste menu te kiezen
	Gebruik de toetsen <u>up</u> en <u>down</u> teneinde te visualiseren 
	Druk op de toets <u>enter</u> om naar de selectie te gaan van reeds gememoriseerde programma's (P01... P07). Wordt getoond 
	Maak gebruik van de toetsen <u>up</u> en <u>down</u> om het gewenste programma te kiezen
	Druk op de toets <u>enter</u> . Wordt getoond 

Als de aangegeven einddatum de gewenste datum is, druk ter bevestiging op de toets  en start de uitvoer van de cyclus op of druk op de toets  om de einddatum van de cyclus te wijzigen.



WIJZIGING AUTOMATISCHE CYCLUS

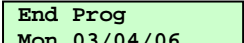

Om de vooraf ingestelde cyclussen te veranderen de volgende instructies volgen.

	Druk op de toets <u>menù</u> om het gewenste menu te kiezen
 	Gebruik de toetsen <u>up</u> en <u>down</u> teneinde te visualiseren 
	Druk op de toets <u>enter</u> om naar de selectie te gaan van reeds gememoriseerde programma's (P01... P07). Wordt getoond 
 	Maak gebruik van de toetsen <u>up</u> en <u>down</u> om het gewenste programma te kiezen
	Druk op de toets <u>enter</u> om de modaliteit voor het instellen van het gekozen programma te betreden
	Met de toets <u>down</u> is het mogelijk om van een fase naar een andere fase over te gaan en op het display wordt de fase van de cyclus met de huidige setpoint waarden weergegeven
	Druk op de toets <u>enter</u> om de wijziging te betreden. De waarde voor de <i>Uren</i> begint te knippen. Gebruik voor het wijzigen van de waarde de toetsen  en  .
	Druk op de toets <u>enter</u> om de nieuwe waarde te bevestigen, de waarde knippert niet langer. De waarde voor de <i>Minuten</i> begint te knippen. Gebruik voor het wijzigen van de waarde de toetsen  en  .
	Druk op de toets <u>enter</u> om de nieuwe waarde te bevestigen, de waarde knippert niet langer. De <i>SetPoint</i> waarde voor <i>Temperaturen</i> begint te knippen. Gebruik voor het wijzigen van de waarde de toetsen  en  .
	Druk op de toets <u>enter</u> om de nieuwe waarde te bevestigen, de waarde knippert niet langer. De <i>SetPoint</i> waarde voor de <i>Vochtigheid</i> begint te knippen (<i>indien aanwezig</i>). Gebruik voor het wijzigen van de waarde de toetsen  en  .
	Druk op de toets <u>enter</u> om de nieuwe waarde te bevestigen, de waarde knippert niet langer. Gebruik de toetsen  en  voor het kiezen van andere fases en om hier de <i>SetPoint</i> van te wijzigen.

De druk op de toets  maakt het mogelijk om het programma op te slaan en naar het vorige menu terug te keren.

De druk op de toets  maakt het mogelijk om de uitvoer van het programma op te starten. Het display toont de datum voor het einde van de cyclus. 

Als de aangegeven einddatum de gewenste datum is, druk ter bevestiging op de toets  en start de uitvoer van de cyclus op of druk op de toets  om de einddatum van de cyclus te wijzigen.

De dag knippert, verplaats met de toets  de datum voor het einde van het programma, druk op de toets  om de nieuwe datum te bevestigen en druk op de toets  om de uitvoer van de cyclus op te starten.

UITVOER VAN EEN AUTOMATISCHE CYCLUS

Tijdens de uitvoer van een automatische cyclus toont het display:

P2 Locking
T=19°C

Door het nummer van het programma in uitvoer, de fase in uitvoer, de actuele temperatuur in de cel en als deze fase tevens de bevochtiging met meter voorziet aan te geven wordt het aanwezige percentage aan vocht getoond.

Weergave datum en tijd van de fases

Druk op de toets  om de datum en tijd voor het einde van de fase in uitvoer weer te geven.

Druk op de toets  om de datum en tijd voor het einde van de volgende fases weer te geven.

Wordt getoond

End PH 0 09:00
Mon 03/04/09

Waarbij F0 aangeeft dat de fase 0, of te wel de Blokkeringsfase, van het programma in uitvoer is, De andere fases worden aangegeven met:

F1 voor Conservering

F2 voor Activering

F3 voor Rijzen

F4 voor Afremming

De druk op de toets  of een time-out van 5 seconden brengen u naar de vorige weergave terug.

Weergave staat INPUT/OUTPUT

Druk op de toets  om de staat van de INPUT/OUTPUT weer te geven.

C D E R V H U
1 0 0 1 1 0 0

De druk op de toets  of een time-out van 20 seconden brengen u naar de vorige weergave terug.

Weergave datum en tijd

Druk op de toets  om de datum en tijd weer te geven.







08/02/2007
Tue 17:35

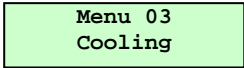

De druk op de toets  of een time-out van 5 seconden brengen u naar de vorige weergave terug.

Op elk gewenst moment blokkeert de druk op de toets  de uitvoer van de cyclus. De cyclus blijft hoe dan ook geselecteerd.

KOELCYCLUS

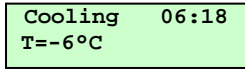

We raden u aan om een koelcyclus op te starten alvorens u een willekeurige cyclus selecteert.

	Druk op de toets <u>menù</u> om het gewenste menu te kiezen
 	Gebruik de toetsen <u>up</u> en <u>down</u> teneinde te visualiseren 
	Druk op de toets <u>enter</u> om de modaliteit voor het wijzigen van de SetPoint te betreden. De SetPoint waarde van de Temperatuur knippert, maak gebruik van de toetsen  en  om de waarde te wijzigen

	Druk op de toets <u>enter</u> om de nieuwe waarde te bevestigen
	Druk op de toets <u>start/stop</u> om onmiddellijk de koelcyclus te activeren Wordt getoond 

Met een druk op de toets  is het mogelijk om naar de wijziging van de SetPoint terug te keren.





UITZETTEN

In elk geval om de apparatuur te stoppen is het voldoende om op de -toets te drukken;
op het display wordt getoond 

ATTENTIE: de toets  isoleert het apparaat NIET van de elektrische spanning.

Om het apparaat te isoleren van de elektrische spanning de stekker uit het stopcontact trekken. (17)

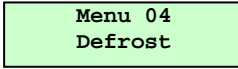

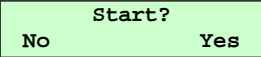



ONTDOOIEN

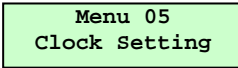

	Druk op de toets <u>menù</u> om het gewenste menu te kiezen
	Gebruik de toetsen <u>up</u> en <u>down</u> teneinde te visualiseren 
	Druk op de toets <u>enter</u> om een aanvraag voor een ontdooicyclus te starten Wordt getoond 

Druk op de toets  om het menu te verlaten en het ontdooien wordt niet geactiveerd.

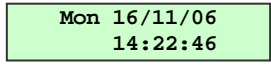







Druk op de toets  om het ontdooien te activeren.

KLOK INSTELLEN

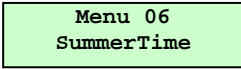
	Druk op de toets <u>menù</u> om het gewenste menu te kiezen
	Gebruik de toetsen <u>up</u> en <u>down</u> teneinde te visualiseren 
	Druk op de toets <u>enter</u> om naar de tijdsinstellingen te gaan. Wordt getoond  Maak gebruik van de toetsen  en  om het knipperende cijfer te wijzigen.

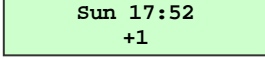
	Druk op de toets <u>enter</u> om de waarde te bevestigen en door te gaan naar het volgende getal
	Druk op de toets <u>menu</u> om de selectie te verlaten

ZOMERTIJD INSTELLEN















	Druk op de toets <u>menu</u> om het gewenste menu te kiezen
	Gebruik de toetsen <u>up</u> en <u>down</u> teneinde te visualiseren 
	Druk op de toets <u>enter</u> om de modaliteit voor het instellen van de zomertijd te betreden. Wordt getoond  Druk op de toetsen  en  om de tijd te wijzigen.
	Druk op de toets <u>enter</u> om de nieuwe waarde te bevestigen
	Druk op de toets <u>menu</u> om de selectie te verlaten

TAAL

	Druk op de toets <u>menu</u> om het gewenste menu te kiezen
	Gebruik de toetsen <u>up</u> en <u>down</u> teneinde te visualiseren 
	Druk op de toets enter om de gebruikte taal weer te geven. Wordt getoond 
	Gebruik de toetsen <u>up</u> en <u>down</u> om de gewenste taal te visualiseren
	Druk op de toets <u>enter</u> om de keuze te bevestigen
	Druk op de toets <u>menu</u> om de selectie te verlaten

PARAMETERS

AANPASSEN PARAMETERS

	Druk op de toets <u>menu</u> om het gewenste menu te kiezen
 	Gebruik de toetsen <u>up</u> en <u>down</u> teneinde te visualiseren Menu 08 Set Up
	Druk op de toets <u>enter</u> om de keuze te bevestigen. Wordt getoond Set Up Password 0
 	Gebruik de toetsen <u>up</u> en <u>down</u> om het password "-19" te selecteren
	Druk op de toets <u>enter</u> om de keuze te bevestigen. Het eerste ondermenu wordt getoond Set Up 01 Parameters
	Druk op de toets <u>enter</u> om naar de instellingen van de parameters te gaan De eerste parameter verschijnt P01=-5°C
 	Gebruik de toetsen <u>up</u> en <u>down</u> om door alle controleparameters te bladeren
	Druk op de toets <u>enter</u> om de keuze te bevestigen
 	Gebruik de toetsen <u>up</u> en <u>down</u> om de nieuwe waarde van de parameter te selecteren
	Druk op de toets <u>enter</u> om de keuze te bevestigen
	Druk op de toets <u>menu</u> om terug te keren naar het Hoofdmenu

OMSCHRIJVING PARAMETERS

Nr.	Beschrijving	Default -2/+30°C	Default -5/+30°C	Default -18/+30°C	Min	Max	Eenheid
<i>Algemene configuraties</i>							
P1	Keuze weergave bij power on 0 = geen 1 = EVCO s.r.l.	1	1	1	0	1	---
P2	0 = Celsius 1 = Fahrenheit	0	0	0	0	1	---
P3	Offset sonde cel	0	-2	-2	-15	15	°C/°F
P4	Offset meter verdamp(er)	0	0	0	-15	15	°C/°F
P5	Ondergrens sonde vochtigheid	0	0	0	0	P6	%
P6	Bovengrens sonde vochtigheid	100	100	100	P5	200	%









Nr.	Beschrijving	Default -2/+30°C	Default -5/+30°C	Default -18/+30°C	Min	Max	Eenheid
P7	Polariteit ingang voor contact deur 0 = NO 1 = NC	0	0	0	0	1	---
P8	Polariteit ingang BT voor thermostaat 0 = NO 1 = NC	0	0	0	0	1	---
P9	Duur Power down om het automatische programma te hervatten	15	15	15	1	60	minuten
P10	Keuze gedrag na power down voor automatisch programma 0 = een automatische cyclus start alleen op als de power down korter dan P9 minuten is 1 = een automatische cyclus herstart altijd	1	1	1	1	1	---
P11	Duur Power down om het handmatige programma te hervatten	15	15	15	1	60	minuten
P12	Keuze gedrag na power down voor handmatig programma 0 = een handmatige cyclus start alleen op als de power down korter dan P11 minuten is 1 = een handmatige cyclus herstart altijd	1	1	1	0	1	---
Setpoint							
P13	Min setpoint instelbaar koud	-2	-5	-24	-30	P14	°C/°F
P14	Max setpoint instelbaar koud	10	10	5	P13	90	°C/°F
P15	Vertraging koud	2	2	2	1	10	°C/°F
P16	Dode zone koud voor koelen, blokkering en conservering	0	0	0	0	10	°C/°F
P17	Dode zone koud voor verwarming, activering en rijzen	0	0	0	0	10	°C/°F
P18	Dode zone koud voor klimaatbeheersing en afremming	0	0	0	0	10	°C/°F
P19	Min setpoint instelbaar warm	5	5	5	0	P20	°C/°F
P20	Max setpoint instelbaar warm	30	30	30	P19	90	°C/°F
P21	Vertraging warm	1	1	1	1	10	°C/°F
P22	Dode zone warm voor verwarming, activering en rijzen	1	1	1	0	10	°C/°F
P23	Dode zone warm voor klimaatbeheersing en afremming	1	1	1	0	10	°C/°F
P24	Aantal stappen afstelling resistenties bij stimuleren	9	9	9	1	10	---
P25	Aantal stappen afstelling resistenties bij rijzen	1	1	1	1	10	---
Tijden Compressor							
P26	Vertraging tussen twee achtereenvolgende on van de compressor	3	3	3	0	60	minuten
P27	Vertraging tussen een off en een achtereenvolgende on van de compressor	2	2	2	0	60	minuten
P28	Vertraging aanzetten compressor vanaf power on	1	1	1	0	255	minuten
P29	Duur geforceerde inschakeling compressor aan het begin van de fases voor activering, rijzen en afremmen	0	0	0	0	60	minuten
Tijden Weerstanden							
P30	Minimum tijd activering weerstanden	0	0	0	0	255	seconden
Bevochtiging en Ontvochtiging							
P31	Laagste temperatuurlimiet cel voor bevochtiging/ontvochtiging	5	5	5	0	90	°C/°F
P32	Modaliteit beheer vochtigheid 0 = met sonde vochtigheid 1 = met cyclussen op tijd op basis van het ingestelde percentage 2 = met stappen van een minuut	0	0	0	0	2	---
P33	Pauzetijd indien P32 = 2	10	10	10	0	60	minuten
P34	Duur cyclus van bevochtiging indien P32 = 1	60	60	60	30	600	seconden
P35	Maximumtijd bevochtiging indien P32 = 1	30	30	30	0	P34	seconden
P36	Activeren bevochtiging tijdens de blokkeringfases voor het rijzen en conservering 0 = gedeactiveerd 1 = geactiveerd	0	0	0	0	1	---
P37	Vertraging voor bevochtiging	1	1	1	1	100	%
P38	Dode zone voor bevochtiging	4	4	4	0	100	%
P39	Band voor Proportionele Afstelling voor Bevochtiging	4	4	4	0	20	%
P40	Cyclustijd voor Prop.Afst. Bevochtiging	1	1	1	1	255	Seconden/ minuten
P41	Base tijden voor Cyclustijd 0 = seconden 1 = minuten	1	1	1	0	1	---
P42	Vertraging voor ontvochtiging	1	1	1	1	100	%
P43	Dode zone voor ontvochtiging	5	5	5	0	100	%
P44	Duur Posing Ontvochtiging met Elektroklep	1	1	1	1	255	seconden
Ventilatie							
P45	Activering Proportionele Afstelling Ventilatoren Verdampers 0 = afstelling ON/Off 1 = proportionele afstelling	0	0	0	0	1	---

Nr.	Beschrijving	Default -2/+30°C	Default -5/+30°C	Default -18/+30°C	Min	Max	Eenheid
P46	Werking koelingen verdamper voor blokkering rijzen 0 = parallelwerking 1 = continue werking	1	1	1	0	1	---
P47	Werking koelingen verdamper voor conserveren 0 = parallelwerking 1 = continue werking	1	1	1	0	1	---
P48	Werking koelingen verdamper voor stimuleren 0 = parallelwerking 1 = continue werking	0	0	0	0	1	---
P49	Werking koelingen verdamper voor rijzen 0 = parallelwerking 1 = continue werking	0	0	0	0	1	---
P50	Werking koelingen verdamper voor vertraging 0 = parallelwerking 1 = continue werking	0	0	0	0	1	---
P51	Werking koelingen verdamper voor koeling 0 = parallelwerking 1 = continue werking	1	1	1	0	1	---
P52	Werking koelingen verdamper voor verwarming 0 = parallelwerking 1 = continue werking	0	0	0	0	1	---
P53	Werking koelingen voor klimatisering 0 = parallelwerking 1 = continue werking	0	0	0	0	1	---
P54	Vertraging disactivering koelingen verdamper in parallelwerking	1	1	1	0	255	minuten
P55	Duur in werking zijn van ventilatoren verdamper mits in parallelfunctie	1	1	1	0	255	minuten
P56	Pauzetijd koelingen verdamper indien in parallelwerkng	1	1	1	0	255	minuten
P57	Minimum Snelheid Ventilatoren Verdamper	0	0	0	0	P58	%
P58	Maximum Snelheid Ventilatoren Verdamper	100	100	100	P57	100	%
P59	Minimum Snelheid Ventilatoren Verdamper tijdens Ontvochting	20	20	20	P57	P58	%
Ontdooien							
P60	Temperatuur Verdamper voor einde ontdooien	8	8	8	-40	99	°C
P61	Interval tussen twee opeenvolgende ontdooiprocessen 0 = het ontdooien herhaalt zich niet	8	8	6	0	10	ore
P62	Maximale duur ontdooicyclus	10	10	30	1	120	minuten
P63	Tijd van uitdruipen	2	2	3	0	30	minuten
P64	Status koelingen gedurende het ontdooien	0	0	0	0	1	---
P65	Tijdsduur blokkering koelingen na uitdruipen	2	2	2	0	15	minuten
Afkoelen							
P66	Minimum Setpoint voor Afkoelen	-2	-5	-5	-30	P67	°C
P67	Maximum Setpoint voor Afkoelen	10	10	10	P66	30	°C
P68	Preset Afkoelen	-2	-5	-5	P66	P67	°C
Instelling en Wijziging Programma's							
P69	Activering Instelling Programma's	1	1	1	0	1	---
P70	Activering Wijziging Programma's	1	1	1	0	1	---
P71	Besturing K3: 0=Elektroklep; 1= Verlichting; 2= Ontvochting	1	1	1	0	2	---
P72	Besturing Compressor bij Open Deur: 0 = geen enkel effect; 1 = uitschakeling compressor	0	0	0	0	1	---
P73	Tijd ontdooien: 0 = Weerstand, 1 = Warm Gas	0	0	0	0	1	---
P74	Hoog temperatuuralarm Verdamper	55	55	55	0	70	°C
P75	Activering hoog temperatuuralarm Verdamper: 0= niet geactiveerd; 1= geactiveerd	1	1	1	0	1	---
P76	Activering van de Ontvochting 0= gedeactiveerd 1= geact. tijdens Activering, Rijzen, Afremmen, Klimaatbeheersing, Verwarming 2= geactiveerd tijdens Blokkering en Conservering	0	0	0	0	2	---
P77	Tijd Weerstand ON	3	3	3	1	255	Seconden/ minuten
P78	Tijd Weerstand OFF (0= weerstanden altijd aan)	1	1	1	0	255	Seconden/ minuten

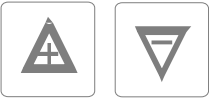

Nota



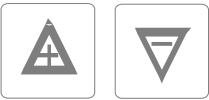

- Controleer de tijden voor de bescherming van de compressor aangezien ze default op nul ingesteld zijn.
- De parameters P5 en P6 zijn gebruikt om de range van de sonde vochtigheid vast te stellen. De parameter P5 moet zijn ingesteld gelijk aan het vochtigheidspercentage overeenkomend met 4mA en de parameter P6 moet zijn ingesteld gelijk aan het vochtigheidspercentage overeenkomend met 20mA.
- Na een aanpassing van parameter P32 de setpoint van vochtigheid van de automatische en de handmatige programma's verifiëren.

INGANGEN EN UITGANGEN

	Druk op de toets <u>menù</u> om het gewenste menu te kiezen																																		
	Gebruik de toetsen <u>up</u> en <u>down</u> teneinde te visualiseren <div style="float: right; border: 1px solid black; padding: 2px; background-color: #e0ffe0;"> Menu 08 Set Up </div>																																		
	Druk op de toets <u>enter</u> om de keuze te bevestigen. Wordt getoond <div style="float: right; border: 1px solid black; padding: 2px; background-color: #e0ffe0;"> Set Up Password 0 </div>																																		
	Gebruik de toetsen <u>up</u> en <u>down</u> om het password “-19” te selecteren																																		
	Druk op de toets <u>enter</u> om de keuze te bevestigen. Het eerste ondermenu wordt getoond <div style="float: right; border: 1px solid black; padding: 2px; background-color: #e0ffe0;"> Set Up 01 Parameters </div>																																		
	Gebruik de toetsen <u>up</u> en <u>down</u> teneinde te visualiseren <div style="float: right; border: 1px solid black; padding: 2px; background-color: #e0ffe0;"> Set Up 02 Inputs/Outputs </div>																																		
	Druk op de toets <u>enter</u> om naar de modaliteit visualisering input en output te gaan Wordt getoond <div style="float: right; border: 1px solid black; padding: 2px; background-color: #e0ffe0;"> Cell -6°C Evap -15°C </div>																																		
	Gebruik de toetsen <u>up</u> en <u>down</u> om door de te visualiseren formaten te bladeren <div style="display: flex; justify-content: space-between; margin-top: 10px;"> <div style="width: 45%;"> <table border="1" style="background-color: #e0ffe0; font-size: small;"> <tr><td>Cell</td><td>-6°C</td></tr> <tr><td>Evap</td><td>15°C</td></tr> </table> <p>Waarde temperatuur Cel en Verdamer</p> <table border="1" style="background-color: #e0ffe0; font-size: small;"> <tr><td>Humidity</td><td>14%</td></tr> </table> <p>Waarde vochtigheidsmeter</p> <table border="1" style="background-color: #e0ffe0; font-size: small;"> <tr><td>C D E R V H U</td><td></td></tr> <tr><td>1 0 0 1 1 0 0</td><td></td></tr> </table> <p>Status output 1 = relè geactiveerd 0 = relè gedisableerd</p> <table border="1" style="background-color: #e0ffe0; font-size: small;"> <tr><td>DI1</td><td>DI2</td><td>FAN</td><td></td></tr> <tr><td>0</td><td>1</td><td>98</td><td></td></tr> </table> <p>Status digitale input en snelheid van de koelingen verdamer</p> </div> <div style="width: 45%; font-size: x-small;"> <table border="1" style="width: 100%; border-collapse: collapse;"> <tr><td>C</td><td>Compressor</td><td>V</td><td>Ventilatoren</td></tr> <tr><td>D</td><td>Defrost</td><td>H</td><td>Gen stoom</td></tr> <tr><td>EV</td><td>Verlichting Ontv.</td><td>U</td><td>Bevochtigingsinstallatie</td></tr> <tr><td>R</td><td>Weerstand</td><td></td><td></td></tr> </table> </div> </div>	Cell	-6°C	Evap	15°C	Humidity	14%	C D E R V H U		1 0 0 1 1 0 0		DI1	DI2	FAN		0	1	98		C	Compressor	V	Ventilatoren	D	Defrost	H	Gen stoom	EV	Verlichting Ontv.	U	Bevochtigingsinstallatie	R	Weerstand		
Cell	-6°C																																		
Evap	15°C																																		
Humidity	14%																																		
C D E R V H U																																			
1 0 0 1 1 0 0																																			
DI1	DI2	FAN																																	
0	1	98																																	
C	Compressor	V	Ventilatoren																																
D	Defrost	H	Gen stoom																																
EV	Verlichting Ontv.	U	Bevochtigingsinstallatie																																
R	Weerstand																																		
	Druk op de toets <u>menu</u> om terug te keren naar het Hoofdmenu																																		

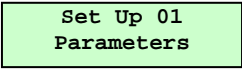
DEFAULT PARAMETERS HERSTELLEN

	Druk op de toets <u>menù</u> om het gewenste menu te kiezen
	Gebruik de toetsen <u>up</u> en <u>down</u> teneinde te visualiseren <div style="float: right; border: 1px solid black; padding: 2px; background-color: #e0ffe0;"> Menu 08 Set Up </div>
	Druk op de toets <u>enter</u> om de keuze te bevestigen. Wordt getoond <div style="float: right; border: 1px solid black; padding: 2px; background-color: #e0ffe0;"> Set Up Password 0 </div>
	Gebruik de toetsen <u>up</u> en <u>down</u> om het password “-19” te selecteren

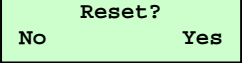











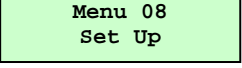

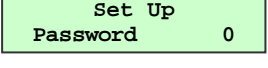



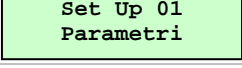

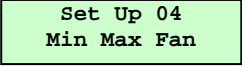
	Druk op de toets <u>enter</u> om de keuze te bevestigen. Het eerste ondermenu wordt getoond 
 	Gebruik de toetsen <u>up</u> en <u>down</u> teneinde te visualiseren 
	Druk op de toets 'enter' om een aanvraag te starten voor het wissen van geregistreerde gegevens in het geheugen. Wordt getoond 

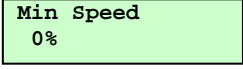
Druk op de toets  om het menu te verlaten en geen herstel uit te voeren.

Druk op de toets  om de originele default parameters te herstellen.

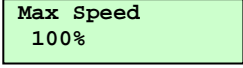
Druk op de toets  om terug te keren naar het Hoofdmenu.

AFSTELLEN VAN DE VENTILATORSNELHEID

	Druk op de toets <u>menù</u> om het gewenste menu te kiezen
 	Gebruik de toetsen <u>up</u> en <u>down</u> teneinde te visualiseren 
	Druk op de toets <u>enter</u> om de keuze te bevestigen. Wordt getoond 
 	Gebruik de toetsen <u>up</u> en <u>down</u> om het password "-19" te selecteren
	Druk op de toets <u>enter</u> om de keuze te bevestigen. Het eerste ondermenu wordt getoond 
 	Gebruik de toetsen <u>up</u> en <u>down</u> teneinde te visualiseren 
	Druk op de toetsn <u>enter</u> om de modaliteit voor het afstellen van de ventilatorsnelheid te betreden. Wordt getoond 
	Druk op de toets <u>enter</u> om de wijziging te betreden. De waarde begint te knipperen. Gebruik voor het wijzigen van de waarde de toetsen  en  .
	Druk op de toets <u>enter</u> om de nieuwe waarde te bevestigen. Wordt getoond  Gebruik voor het wijzigen van de waarde de toetsen  en  .
	Druk op de toets <u>enter</u> om de nieuwe waarde te bevestigen.

MENU

Druk op de toets menu om terug te keren naar het Hoofdmenu

ALARMSIGNALLEN

Visuele en akoestische signaleringen zijn aanwezig in het geval van storingen.

Meter Cel

Een storing aan de meter veroorzaakt een Alarm Meter Cel, de buzzer gaat af en op het display knippert de foutmelding:

ALL CellSensor

Elke willekeurige cyclus wordt onderbroken en alle uitgangen worden gedeactiveerd. De buzzer kan uitgeschakeld worden door op een willekeurige toets te drukken. Zodra de foutmelding verdwijnt wordt de cyclus hervat.

Veiligheidsthermostaat

Als het thermostaatalarm door de kaart opgemerkt wordt gaat de buzzer af en verschijnt op het display het alarmbericht:

ALL Thermostat

Elke willekeurige cyclus wordt onderbroken en alle uitgangen worden gedeactiveerd. De buzzer kan uitgeschakeld worden door op een willekeurige toets te drukken.

Zodra de foutmelding verdwenen is druk op de toets  om de kaart weer te activeren.

Meter verdamper

Een defect aan de meter veroorzaakt een Alarm Defect Meter Verdamper, de buzzer gaat af en op het display verschijnt het alarmbericht:

ALL EvapSensor

Elke willekeurige cyclus wordt onderbroken en alle uitgangen worden gedeactiveerd. De buzzer kan uitgeschakeld worden door op een willekeurige toets te drukken. Zodra de foutmelding verdwijnt wordt de cyclus hervat.

Hoge temperatuur Verdamper

Als de Meter Verdamper de in P74 ingestelde waarde bereikt wordt het hoog temperatuuralarm Verdamper geactiveerd. De buzzer gaat af en op het display verschijnt het alarmbericht:

ALL High T Evap

Elke willekeurige cyclus wordt onderbroken en alle uitgangen worden gedeactiveerd. De buzzer kan uitgeschakeld worden door op een willekeurige toets te drukken.

Zodra de foutmelding verdwenen is druk op de toets  om de kaart weer te activeren.

Vochtigheidsmeter

Een defect aan de meter veroorzaakt een Alarm Defect Vochtigheidsmeter, de buzzer gaat af en op het display knippert het alarmbericht:

ALL HumSensor

Elke willekeurige cyclus wordt onderbroken en alle uitgangen worden gedeactiveerd. De buzzer kan uitgeschakeld worden door op een willekeurige toets te drukken. Zodra de foutmelding verdwijnt wordt de cyclus hervat.

MicroDeur

Elke keer dat de deur geopend wordt verschijnt het knipperende bericht Deur Open:

Door Open

Het openen van de deur tijdens een cyclus blast chillen brengt de Ventilatoren, de Weerstand en de Bevochtigingsinstallatie tot stilstand.

De buzzer gaat af maar kan uitgeschakeld worden door op een willekeurige toets te drukken en de signalering verdwijnt automatisch zodra de deur afgesloten wordt.

Elke keer dat de Deur geopend wordt gaat de Verlichting aan.

RTC storing

Qualora si rilevi un malfunzionamento dell'RTC, viene segnalato un allarme di RTC; il buzzer suona e sul display lampeggia la scritta di allarme:

ALL RTC

Elke willekeurige cyclus wordt onderbroken en alle uitgangen worden gedeactiveerd.

De buzzer kan uitgeschakeld worden door op een willekeurige toets te drukken.

Het is mogelijk om het Menu Klok Instellen te betreden en de huidige waarden van de RTC te resetten waarna de kaart in standby gaat.

EEPROM alarm

Indien zich een incoherentie voordoet in de gegevens die op de Eeprom opgeslagen zijn wordt een Eeprom alarm geactiveerd; de buzzer gaat af en op het display knippert het alarmbericht:

ALL EEprom

Elke willekeurige cyclus wordt onderbroken en alle uitgangen worden gedeactiveerd.

De buzzer kan uitgeschakeld worden door op een willekeurige toets te drukken.

Druk op de toets  om de kaart te activeren. Na de activering gaat de kaart in standby.

NB: na een Eeprom alarm worden alle parameters op de default waarden teruggebracht.

ONREGELMATIGHEDEN IN DE WERKING

In het geval het apparaat niet goed functioneert, dient men alvorens de plaatselijke Reparatiedienst te bellen, te controleren of:

de hoofdschakelaar 1 verlicht is en er spanning op het lichtnet staat. (63)

de waarde van de ingestelde temperatuur de gewenste is. (65)

de deuren goed gesloten zijn.

het apparaat niet in de buurt van een warmtebron staat; (38)

de condensator schoon is en de ventilator regelmatig werkt;

Een overmatige ijsvorming op de verdampingsaccu dient te worden vermeden.

In geval genoemde controles een negatief resultaat opgeleverd hebben, zich tot de servicedienst van de zone wenden onder vermelding van aanwijzingen over het model en het serie- en registratienummer, die op het kenmerkenplaatje weergegeven zijn, kan braakneigingen veroorzaken.. (11)

DAGELIJKSE REINIGING

Om een optimale hygiëne en behoud van de koelkast (66) te garanderen is het raadzaam dagelijks, volgens de hieronder beschreven instructie, de koelkast schoon te houden :

Zorgvuldig de externe oppervlaktes van het apparaat reinigen door er met een zachte, in water met neutraal wasmiddel gedompelde, uitgewrongen spons over te gaan, en dit enkel in de glansrichting.

gebruik geen bijtende schoonmaakmiddelen of reinigingsmiddelen die chloor bevatten.

wij raden U aan enkel de volgende reinigingsmiddelen te gebruiken;
desinfecterend reinigingsmiddel met meervoudige werking (bevat niet-ionogene oppervlakte-actieve stoffen, benzalkoniumchloride, substanties met chelaat en pH tampon)
reinigingsmiddel voor laboratoria, neutraal, voor handmatig reinigen; (bevat aniogene en niet-ionogene oppervlakte-actieve stoffen)
ontvettend reinigingsmiddel te gebruiken in omgevingen met etenswaren; (bevat aniogene oppervlakte-actieve stoffen en EDTA)

voor gebruik de reinigingsmiddelen eventueel verdunnen, volgens de gebruiksaanwijzingen vermeldt op het etiket.
de reinigingsmiddelen minstens 5 min. laten inwerken.
de wanden van de koelkast grondig naspoelen met een spons meerdere keren nat gemaakt onder stromend water (69)
goed afdrogen met een schone doek

OPGELET:Geen spullen gebruiken die op enigerlei wijze krassen kunnen veroorzaken wat roestvorming tot gevolg heeft. (68)

Eventuele vlekken door voedsel of restjes binnen het apparaat verwijderen (zie volgende paragraaf).

VOEDSELVLEKKEN EN HARD GEWORDEN RESTEN

In het geval er etensvlekken of voedselresten in de koelkast aanwezig zijn deze met water schoonmaken en verwijderen voordat deze verharden.

Als de voedselresten reeds verhard zijn deze als volgt verwijderen:

Gebruik een zachte spons gedompeld in lauw water met reinigingsmiddel (men kan dezelfde reinigingsmiddelen gebruiken als vermeldt voor de dagelijkse reiniging maar dan met hogere concentratie zoals vermeldt op het etiket). (72)

De verharde voedselresten nat maken, zodat deze minstens 30 min. vochtig blijven, door ongeveer om de 5 min. de spons natgemaakt in water met reinigingsmiddel er overheen te vegen.

Na het weken de resten wegvegen met de spons, natgemaakt in water met neutraal reinigingsmiddel.

Indien nodig een houten spatel of een roestvrij stalen staalsponsje gebruiken, er aandacht aan bestedend de oppervlakte van de koelkast niet te beschadigen.(70)

Na deze specifieke reiniging is het raadzaam een algemene (dagelijkse) reiniging van alle interne oppervlakten van de koelkast uit te voeren.

Aan het einde van de reiniging met een vochtige spons, veelvuldig gespoeld onder stromend water, de wanden vegen.

Grondig afdrogen met een schone doek.

Ook de onderliggende gedeeltes moeten goed gereinigd en onderhouden worden voor een perfecte hygiene. Met water en zeep of neutraal schoonmaakmiddel reinigen. (71)

Bescherm de beplating met siliconenwas.

REGELMATIG SCHOONMAAK EN ONDERHOUD

Voor een constant rendement van de apparatuur wordt aanbevolen regelmatig schoonmaak- en onderhoudswerkzaamheden uit te voeren.

Voor hiermee te beginnen als volgt te werk gaan:

de hoofdschakelaar op OFF zetten (16)

de stekker uit het stopcontact trekken en wachten tot het apparaat geheel ontdooid is. (17)

De condensator van de koelgroep en de verdampers poetsen met een stofzuiger, een penseel of een niet-metalen borstel, nadat de beschermstukken verwijderd zijn. (73)

OPGELET:De reiniging en het onderhoud van het koelsysteem en van de kompressorruimte moet uitgevoerd worden door een gespecialiseerd en geautoriseerd technicus, en kan daarom niet worden uitgevoerd door ongeschikt personeel. (30)

Bij het reinigen van de externe en interne oppervlaktes van het apparaat de aanwijzingen volgen die in de paragraaf over de dagelijkse reiniging weergegeven worden.

De apparaten met positieve temperatuur NORMALE TEMPERATUUR zijn van een afvoer voorzien in het onderste gedeelte van de ruimte. Controleren dat het gat niet verstopt is en eventueel reinigen. (75)
Na het sluitpaneel van de kit generator damp te hebben geopend, de stoompijp demonteren en ontkalken met behulp van stromend water. De boiler van de kit disassembleren en ontkalken met behulp van stromend water. Alle onderdelen reassembleren. (76a)
De handelingen van algemene reiniging en onderhoud zijn nu beëindigd.

ONDERBREKING VAN HET GEBRUIK

In geval van langdurige onderbreking van het gebruik van het apparaat dient men de volgende handelingen te verrichten om het in zo goed mogelijke staat te bewaren:

- de lichtnetschakelaar op OFF zetten (16)
- de stekker uit het stopcontact nemen (17)
- het apparaat legen en reinigen zoals beschreven in het hoofdstuk "REINIGING" (76)
- het in de dampgenerator boiler aanwezige water legen na de schroefring te hebben verwijderd en de pijp eruit te hebben gehaald. (76a)
- de deuren van de cellen gedeeltelijk open laten om te voorkomen dat zich een onaangename geur vormt. (77)
- de kompressorgroep met een nylon doek bedekken om deze tegen stof te beschermen. (78)

NUTTIGE TIPS VOOR HET ONDERHOUD VAN ROESTVRIJ STAAL

De apparaten zijn vervaardigd in roestvrij staal AISI 304. (79)
Voor de reiniging en het onderhoud van de delen in roestvrij staal dient men het volgende in acht te nemen, er rekening mee houdend dat de belangrijkste voorwaarde het waarborgen van niet-giftigheid en hygiene van de produkten is.

Het roestvrij staal heeft een dun laagje oxyde wat de vorming van roest voorkomt. Er zijn verschillende substanties en schoonmaakmiddelen die deze laag kunnen beschadigen of krassen waardoor corrosie ontstaat. Voor een schoonmaakmiddel te gebruiken dient men eerst te informeren wat het meest geschikte neutrale schoonmaakmiddel is dat geen corrosie op staal veroorzaakt. (73)

In het geval van krassen op de oppervlakten, moeten deze gepolijst worden met zeer fijne roestvrije staalwol of een schuursponsje met synthetische vezels waarbij in de glansrichting gewreven moet worden. (80)

OPGELET: Bij het reinigen van roestvrij staal nooit ijzeren voorwerpen gebruiken en deze ook niet op de oppervlakten laten liggen omdat zeer kleine ijzerhoudende deeltjes op de oppervlakte kunnen blijven liggen en zo roestvorming veroorzaken door besmetting, wat de hygiene verslechtert. (81)

STORINGEN IN DE WERKING

Vaak zijn de storingen die eventueel in de werking op kunnen treden te wijten aan kleine oorzaken die u meestal zelf kunt verhelpen. Dus verricht voordat u de technische dienst inschakelt eerst de volgende eenvoudige controles:

PROBLEEM	MOGELIJKE OORZAKEN
Het apparaat gaat niet aan	Controleer of de stekker goed in het stopcontact zit
	Controleer of er stroom naar het stopcontact gevoerd wordt

De binnentemperatuur is te hoog	De afstelling van de elektronische kaart verifiëren
	Ga na dat er geen warmtebron in de buurt is waardoor het apparaat beïnvloed wordt
	Controleer of de deur goed sluit
Het apparaat maakt abnormaal veel lawaai	Controleer of het apparaat vlak staat, als het apparaat niet in balans staat dan kunnen hierdoor dit namelijk trillingen teweeggebracht worden
	Controleer of het apparaat niet in aanraking is met andere apparaten of delen die kunnen gaan resoneren
Onaangename geuren in de koelkast	In de koelkast bevinden zich niet goed verpakte levensmiddelen met een sterke geur (bijvoorbeeld kaas of meloen)
	De binnenkant moet gereinigd worden
Condensvorming op de apparatuur	Hoge luchtvochtigheidsgraad
	De koelkastdeuren zijn niet goed gesloten

Als u na deze controles verricht te hebben constateert dat de storing voortduurt dan moet u zich tot de technische dienst wenden en het volgende melden:

- de aard van de storing
- het model en het serienummer van het apparaat, deze gegevens kunt u van het typeplaatje afleiden, dat onder het bedieningspaneel van het apparaat aangebracht is.

HET AFVALMATERIAAL LOZEN EN HET APPARAAT AFDANKE

OPSLAG VAN HET AFVALMATERIAAL

Oude apparatuur mag niet worden vernietigd via de normale ongesorteerde afvalstroom. Het apparaat moet apart worden ingezameld. Alvorens het apparaat weg te gooien moeten eerst de deuren gedemonteerd worden.

Het afvalmateriaal mag tijdelijk opgeslagen worden in afwachting van het moment waarop de speciale afvalstoffen bij de vuilverwerkende instanties ingeleverd kunnen worden en/of definitief opgeslagen kunnen worden. De wettelijke bepalingen die in het land van de gebruiker van toepassing zijn ten aanzien van de bescherming van het milieu moeten in ieder geval in acht genomen worden.

PROCEDURE VOOR DE RUWE DEMONTAGE VAN HET APPARAAT

In die diverse landen zijn verschillende wetgevingen van toepassing. U moet dan ook de voorschriften die door de wetten en de instanties in het land waar het apparaat gesloopt wordt bepaald worden in acht nemen. In de meeste gevallen kan de oude koelkast bij de betreffende instanties die voor de inzameling/het slopen ervan zorgen ingeleverd worden. Haal de oude koelkast uit elkaar en scheid de diverse onderdelen al naar gelang de chemische samenstelling ervan, waarbij u er rekening mee moet houden dat er in de compressor smeerolie en koelmiddel zit en dat dit opgevangen kan worden en opnieuw gebruikt kan worden. Bovendien moet u er rekening mee houden dat de onderdelen van de koelkast speciaal vuil zijn dat niet bij het huisvuil gezet mag worden maar gescheiden moet worden.

Maak het apparaat volledig onbruikbaar door de voedingskabel en alle mogelijke sluitingen (waar aanwezig) te verwijderen om te voorkomen dat er iemand in opgesloten kan raken.

HET APPARAAT MOET IN IEDER GEVALDOOR VAKMENSEN GEDEMONTEERD WORDEN.

VEILIGHEID BIJ HET VERWERKEN VAN AFGEDANKTE ELEKTRISCHE EN ELEKTRONISCHE APPARATUUR (RICHTLIJN AEEA 2002/96/EG)

Verspreid geen vervuulende materialen in het milieu.

Deze materialen moeten worden verwerkt in overeenstemming met de betreffende geldende wetten.

Volgens de voorschriften van de richtlijn AEEA 2002/96/EG (afgedankte elektrische en elektronische apparatuur), moet de gebruiker, bij het afdanken ervan, de apparatuur in de speciale bevoegde verzamelcentra verwerken of ze op het moment van de nieuwe aankoop nog geïnstalleerd teruggeven aan de verkoper.

Alle apparaten die volgens de AEEA 2002/96/EG richtlijn moeten worden verwerkt zijn herkenbaar aan een speciaal symbol (12)

De illegale verwerking van afgedankte elektrische en elektronische apparaten wordt bestraft met sancties geregeld door de geldende wetten in het gebied waar de overtreding geconstateerd wordt.

AFGEDANKTE ELEKTRISCHE EN ELEKTRONISCHE APPARATEN KUNNEN GEVAARLIJKE STOFFEN BEVATTEN MET POTENTIEEL SCHADELIJKE GEVOLGEN VOOR HET MILIEU EN DE GEZONDHEID VAN DE PERSONEN. WIJ BEVELEN EEN CORRECTE AFVALVERWERKING AAN.

De ééndeurskoelkasten worden standaard geleverd met een naar rechts draaiende deur.

Bij de transformatie met linker scharniering moet men als volgt te werk gaan:

- De schroef "F" verwijderen zodat het instrumentenbord op de zijkanten gekanteld kan worden.
- De twee bevestigingsschroeven van stang "A" en de "blokkeer"-schroef van scharnier "B" losschroeven.
- De deur wegnemen en scharnier "B" en element "e" demonteren door hun montage om te keren.
- Onderstang "d" demonteren en deze aan de tegenovergestelde kant op de daarvoor bestemde plaats opnieuw monteren.
- De deur op zijn plaats brengen door het gat van onderelement "E" over de pin van stang "D" te schuiven.
- Stang "A" aan de tegenovergestelde kant op de structuur bevestigen door de bevestigingsschroeven helemaal aan te schroeven.
- Alvorens de stangschroeven vast te zetten de scharniermaat, die ongeveer 12 mm moet bedragen, en het loodrecht zijn van de hoek van de deur ten opzichte van de structuur controleren.
- de micro aanwezig op het instrumentenbord verplaatsen naar het tegenovergelegen deel, daarbij de hiervoor bedoelde openingen gebruikend.
- Het dashboard opnieuw.

OPMERKING: De demontagehandelingen van de stangen en de hermontage moeten met gesloten deur uitgevoerd worden.

SPECIFICATIES VAN DE KOELVLOEISTOF

R404a: bestanddelen van de vloeistof

trifluorethaan	(HFC 143a)	52%
pentafluorethaan	(HFC 126)	44%
tetrafluorethaan	(HFC 134a)	4%

GWP = 3750
ODP = 0

Gevaren

Een lange inhalatie kan verdovende effecten hebben. Het voortdurend blootstaan kan tot hartritmestoringen leiden en plotselinge dood veroorzaken. Het product, verneveld of als spatten, kan ijsverbrandingen aan ogen en huid veroorzaken.

Maatregelen van eerste hulp

• Inhalatie:

de geblesseerde uit de gevarenzone bergen, hem warm en rustig houden. Zo nodig zuurstof toedienen. Bij ontbrekende of slechts zwakke ademhaling kunstmatige ademhaling doorvoeren. In geval van hartstilstand uitwendige hartmassage doorvoeren en onmiddellijke medische assistentie oproepen.

• Contact met de huid:

de getroffen delen met water laten ontdooien. De besmette kleren verwijderen.

OPGELET: in geval van ijsverbrandingen kunnen de kleren aan de huid vastzitten.

In geval van contact met de huid, zich de handen onmiddellijk en rijkelijk met lauw water wassen. Als er symptomen (zoals irritatie of blarenvorming) opduiken medische assistentie oproepen.

• Contact met de ogen:

de ogen met spoelingoplossing voor ogen of zuiver water voor 10 minuten spoelen, waarbij de oogleden gesloten te houden zijn. Medische assistentie oproepen.

• Doorslikken:

kan braakneigingen veroorzaken. Als de geblesseerde bewust is, hem de mond met water laten spoelen en daarna 200-300 ml water laten drinken. Onmiddellijke medische assistentie oproepen.

• Verdere medische behandeling:

symptomatische behandeling en ondersteuningstherapie indien nodig. Na het blootstaan aan de vloeistof geen adrenaline of gelijksoortige sympathicomimetische stoffen toedienen want er risico van hartritmestoring met mogelijk hartstilstand bestaat.

Ecologische informatie

Persistentie en afbraak

- HFC 143a:

hij breekt in de onderste atmosfeer (troposfeer) langzaam af. Zijn duur in de atmosfeer is 55 jaar.

- HFC 125:

hij breekt in de onderste atmosfeer (troposfeer) langzaam af. Zijn duur in de atmosfeer is 40 jaar.

- HFC 134a:

hij breekt in de onderste atmosfeer (troposfeer) relatief snel af. Zijn duur in de atmosfeer is 15,6 jaar.

- HFC 143a, 125, 134a:

hij heeft geen invloed op de fotochemische smog (d.w.z. hij behoort niet tot de vluchtige organische bestanddelen -VOC- volgens de UNECE-overeenkomst). Hij veroorzaakt geen verdunning van de ozonlaag. De dumping van dit product in de atmosfeer veroorzaakt geen langdurige verontreiniging van de water afvoerende lagen.

HET ELEKTRISCH SCHEMA IS OP DE LAATSTE BLADZIJDE VAN HET BOEKJE WEERGEGEVEN

POS	BESCHRIJVING	POS	BESCHRIJVING
1	KOMPRESSORGROEP	44	ENERGIERELAIS
2	VENTILATOR KONDENSATOR	44A	RELAIS KRACHT PTC
3	KLEM APPARAAT	44B	RELAIS KRACHT MAGNETISCHE SCHAKELAAR
6	HOOFDSCHAKELAAR MET LAMP	56	FILTER
8	ELEKTRISCHE STEKKER	69	AARDKLEM
9	VENTILATOR VERDAMPER	70	VEILIGHEIDSDRUKMETER HOGE DRUK
9A	VENTILATOR VERDAMPER	75	ELEKTROKLEP
9B	VENTILATOR VERDAMPER	76	MAGNETISCHE SCHAKELAAR
10	LAMP BINNENVERLICHTING	85	CONNECTION BOX
10A	LAMP BINNENVERLICHTING	86	SONDE CONDENSATOR
12	ELEKTRISCHE ONTODIKLEP	90	DIGITALE THERMOREGELAAR
14	VOCHTIGHEIDSREGELAAR MET LAMPJE	91	WEERSTAND PTC
15	MICRO SCHAKELAAR VENTILATOREN	96	ELECTRONISCHE KAART
15A	MICRO SCHAKELAAR VENTILATOREN	101	WEERSTAND BUFFER
18	LAMPJE VEILIGHEIDSTHERMOSTAAT	102	BIMETALE VEILIGHEIDSTHERMOSTAAT
19	VEILIGHEIDSTHERMOSTAAT	103	VOCHTIGHEIDSSONDE
20	ANTI-CONDENSWEERSTAND DEUREN	104	NIVEAUREGULATEUR
20A	ANTI-CONDENSWEERSTAND DEUREN	105	NIVEAUSONDE
21	ONTDOOIINGSWEERSTAND	106	VEILIGHEIDSTHERMOSTAAT DAMPGENERATOR
22	WEERSTAND BODEM BAKJE	107	ELEKTRISCHE WEERSTAND KAMER
25	TRANSFORMATOR	108	WEERSTAND DAMPGENERATOR
28	SCHAKELAAR BINNENVERLICHTING	109	SYSTEEMKAART PANEEL REMRIJSKAST
29	TL LAMPEN REAKTOR	110	SYSTEEMKAART BEDIENING REMRIJSKAST
30	STARTER	111	SYSTEEMKAART EXPANSIE RELAIS REMRIJSKAST
31	TL LAMP	112	ZEKERING WATER BEVOCHTING

СОДЕРЖАНИЕ

МЕХАНИЧЕСКОЕ ОПИСАНИЕ	2
ДОПОЛНЕНИЯ	2
ИНДИФИКАЦИОННАЯ ЭТИКЕТКА	2
ОБЩИЕ ЗАМЕЧАНИЯ ПО ПОСТАВКЕ	3
ПРАВИЛА ТЕХНИКИ БЕЗОПАСНОСТИ	3
ИНСТРУКЦИЯ ПО САМОКОНТРОЛЮ БЕЗОПАСНОСТИ	4
ТЕХНИЧЕСКИЕ ХАРАКТЕРИСТИКИ	4
УСТАНОВКА И ЗАПУСК	4
ПАНЕЛИ УПРАВЛЕНИЯ	6
ЗАПУСК	7
ЗАГРУЗКА ПРОДУКТА	7
ФУНКЦИОНИРОВАНИЕ РУЧНОЙ ЦИКЛ – АВТОМАТИЧЕСКИЙ ЦИКЛ	7
ОСТАНОВКА	12
РАЗМОРАЖИВАНИЕ	13
УСТАНОВКА ЧАСОВ	13
УСТАНОВКА ДЕКРЕТНОГО ВРЕМЕНИ	13
ЯЗЫК	14
ПРОГРАММИРОВАНИЕ	14
СИГНАЛИЗАЦИИ	20
ВОЗМОЖНЫЕ ПОЛОМКИ ПРИ ЭКСПЛУАТАЦИИ	21
ЕЖЕДНЕВНАЯ ЧИСТКА	22
ПИЩЕВЫЕ ПЯТНА И ПИЩЕВЫЕ ЗАСОХШИЕ ОСТАТКИ	22
ЧИСТКА И ПЕРИОДИЧЕСКОЕ ТЕХНИЧЕСКОЕ ОБСЛУЖИВАНИЕ	23
ПЕРЕРЫВ В ИСПОЛЬЗОВАНИИ	23
ИНСТРУКЦИИ ПО ЭКСПЛУАТАЦИИ НЕРЖАВЕЮЩЕЙ СТАЛИ	23
ПРОБЛЕМЫ ФУНКЦИОНИРОВАНИЯ	24
ВЫБРОС ОТХОДОВ И ИХ РАЗМЕЩЕНИЕ	24
ПЕРЕУСТАНОВКА ДВЕРЕЙ	25
ТЕХНИЧЕСКАЯ СХЕМА РЕФРИЖЕРАТОРА	25

МЕХАНИЧЕСКОЕ ОПИСАНИЕ

Эта аппаратура спроектирована для охлаждения, подогрева и сохранения пищевых продуктов. Любое другое использование считается неподходящим.

ВНИМАНИЕ: машины не предназначены для установления их на открытом месте или на подвергающихся атмосферным воздействиям пространствах.

Конструктор снимает с себя любую ответственность в случае использования аппаратуры в других целях.

Аппараты в наличии с дверцами из стали.

Аппараты сделаны с охладительным устройством "НОРМАЛЬНАЯ ТЕМПЕРАТУРА" И "НИЗКАЯ ТЕМПЕРАТУРА" для удовлетворения параметров сохранения всех продуктов при разных температурах.(1)

Аппараты оснащены испарителем с крылышками, защищенный от окисления, герметическим компрессором, конденсатором из меди и алюминия, набором для увлажнения, внутренним сопротивлением, зондом увлажнения и соответствующим щитом управления.(2)

Аппараты оснащены щитом управления, отличающегося типом установок относительно типологии аппаратуры (ПОЛОЖИТЕЛЬНАЯ ТЕМПЕРАТУРА, НИЗКАЯ ТЕМПЕРАТУРА).(3)

Компрессоры расположены в верхней части шкафов для лучшей вентиляции и рассеивания тепла. (4)

Аппараты оснащены ванночкой, имеющей приспособление автоматического испарителя конденсации, находящаяся с тыльной стороны аппарата. (5)

Ни один холодильный агрегат не имеет ванночки для сбора конденсации.

Аппараты оснащены двумя разными системами освещения в соответствии с моделью. Внутренние лампочки защищены, чтобы предотвратить контакт с продуктами и удары, которые могут их разбить.(8)

Двери холодильных шкафов оснащены специальными замками с ключами для гарантии надежного закрытия. (9)

Зоны, находящиеся в контакте с пищевыми продуктами выполнены из стали или облицованы нетоксичными материалами.(10)

В группе рефрижераторов используется жидкость, применение которой разрешено действующими законами например HFC.

ДОПОЛНЕНИЯ

Смотри рисунок 7.

ИДЕНТИФИКАЦИОННАЯ ЭТИКЕТКА

Для любой коммуникации с конструктором всегда называть МОДЕЛЬ и НОМЕР ПАСПОРТА машины, находящихся на табличке технических характеристик. (11)

Содержание Таблицы Технических номинальных данных (12)

- | | |
|--------------------------------------|---------------------------------------|
| 1) МОДЕЛЬ | F) ТОК КОРОТКОГО ЗАМЫКАНИЯ |
| 2) ЗАВОД-ИЗГОТОВИТЕЛЬ И АДРЕС | G) ТИП ОХЛАЖДАЮЩЕЙ ЖИДКОСТИ |
| 3) АББРЕВИАТУРА МАРКИРОВКИ СЕ | H) КОЛИЧЕСТВО ОХЛАЖДАЮЩЕЙ ЖИДКОСТИ |
| 4) ГОД ИЗГОТОВЛЕНИЯ | L) КЛАСС ТЕМПЕРАТУРЫ УСТАНОВКИ |
| 5) N° ПАСПОРТА | ХОЛОДИЛЬНИКА |
| 6) КЛАСС ЭЛЕКТРОЗАЩИТЫ | M) МАКСИМАЛЬНОЕ ДАВЛЕНИЕ ВОДЫ |
| 7) КЛАСС ЭЛЕКТРИЧЕСКОЙ ЗАЩИТЫ | N) ТЕМПЕРАТУРА ВОДЫ |
| A) НАПРЯЖЕНИЕ ЭЛЕКТРОПИТАНИЯ | O) РАСХОД ВОДЫ |
| B) ИНТЕНСИВНОСТЬ ЭЛЕКТРИЧЕСКОГО ТОКА | P) МИНИМАЛЬНОЕ ДАВЛЕНИЕ ВОДЫ |
| C) ЧАСТОТА | R) СИМВОЛ ОЭЭО |
| D) ПОТРЕБЛЯЕМАЯ МОЩНОСТЬ | W) МОЩНОСТЬ ОБОГРЕВАТЕЛЬНЫХ ЭЛЕМЕНТОВ |
| E) ОБЩАЯ МОЩНОСТЬ ЛАМП | |

ОБЩИЕ ЗАМЕЧАНИЯ ПО ПОСТАВКЕ

В момент поставки удостовериться в целостности упаковки и что в течение поставки нет повреждений. (13)

После распаковки холодильника необходимо удостовериться в наличии всех частей и компонентов и в соответствии характеристик спецификации вашего заказа.

Если это не так, немедленно сообщить поставщику.(14)

Спасибо Вам за Ваш удачный выбор, будем надеется что Вы сможете самым лучшим образом использовать наши холодильные шкафы, следуя нашим указаниям и предосторожностям, внесенным в это руководство. (15)

Но помните, что запрещено любое воспроизведение настоящего руководства, и что постоянный поиск новшеств и качества технологии в любой момент и без предупреждения может изменить описанные здесь характеристики.

ПРАВИЛА ТЕХНИКИ БЕЗОПАСНОСТИ

ВНИМАНИЕ: перед началом любой операции или чистки необходимо изолировать аппаратуру от электроэнергии:

Переместить выключатель, имеющийся на щитке в положение OFF (16a)

поставить генеральный выключатель в позицию OFF. (16b)

вынуть из розетки шнур питания (17)

ВНИМАНИЕ: не использовать розетки и вилки без заземления. (18)

Розетка сети питания должна иметь ЗАЗЕМЛЕНИЕ. (19)

ВНИМАНИЕ: не пользоваться для соединения удлинителями и тройниками. (20)

ВНИМАНИЕ: перед помещением пищевых продуктов для хранения подождать необходимо время понижения температуры до указанного уровня. (21)

Всегда покрывать продукты специальной пленкой перед помещением их в холодильники. (22)

ВНИМАНИЕ: не ставить горячие продукты и напитки в холодильник. (23)

ВНИМАНИЕ: располагать продукты в таком порядке, чтобы не мешать циркуляции воздуха, не заставлять волновые решетки. Не заставлять зоны работы вентиляторов. (24)

ВНИМАНИЕ: не осуществлять уборку около холодильных шкафов с открытыми дверями.(25)

Не мыть аппаратуру проточной водой под напором.(26)

ВНИМАНИЕ: не использовать для мытья холодильников и вблизи их растворы с добавлением хлора и соляной кислоты или других токсичных веществ. (27)

ВНИМАНИЕ: не заставлять верхнюю часть холодильника и воздушный канал при его функционировании или под напряжением. (28)

ВНИМАНИЕ: не ставить предметы на дно холодильника. Использовать специальные решетки. (29)
Максимальный вес, который выдерживают решетки не должен превышать 48 кг.

Чистка и ремонт рефрижераторного устройства и зоны компрессоров требует вмешательства квалифицированного и уполномоченного техника, поэтому не может осуществляться неквалифицированным персоналом. (30)

В случае поломки или аномалий отключить полностью аппарат из сети; потребовать вмешательства ТЕХОБСЛУЖИВАНИЯ авторизированного центра или центра подлинных запчастей. (31)

Несоблюдение вышеописанных выше инструкций может повлечь за собой ненадежность холодильных шкафов.

ИНСТРУКЦИИ ПО САМОКОНТРОЛЮ ОБОРУДОВАНИЯ

ВНИМАНИЕ: Легко портящиеся продукты должны выниматься из холодильника в момент использования и класться немедленно на место, чтобы они находились вне холодильника меньшее время.

ВНИМАНИЕ: Не замораживать продукты вторично.

ВНИМАНИЕ: Пронумеровать холодильные аппараты и контролировать два раза в день их температуру, записывая показатели в специальный журнал, который нужно хранить 24 месяца.

ВНИМАНИЕ: Возможное время отключение электричества от холодильника можно контролировать электронными часами, для того чтобы удалить продукты, которые могли быть испорченными.

Максимальные температуры, разрешенные для продуктов

Продукт	Нормальная температура складировки (°C)	Максимальная температура транспортировки (°C)
Молоко свежее пастеризованное	0÷+4	9
Свежие сливки	0÷+4	9
Йогурт, творог и свежие сыры	0÷+2	9
Рыбные замороженные изделия	0÷+2	0÷+4

ТЕХНИЧЕСКИЕ ХАРАКТЕРИСТИКИ

Технические характеристики описаны на последней странице инструкции. (32)

УСТАНОВКА И ЗАПУСК

Холодильные шкафы присылаются запечатанными и на поддонах. (33)

Если в момент поставки, после открытия упаковки обнаружатся повреждения или нехватка деталей, то поступать в соответствии с параграфом «ОБЩИЕ ЗАМЕЧАНИЯ ПО ПОСТАВКЕ».

Установку и запуск аппаратуры должен производить специализированный персонал. (30)

Распаковывать осторожно, чтобы не повредить поверхности аппаратуры. (34)

ВНИМАНИЕ: элементы от упаковки (целлофановые мешки, полистирол, пенопласт, гвозди и т.д.) не должны находиться в зоне, где находятся дети, так как составляют потенциальную опасность.

Автокаром приподнять холодильник и осторожно, чтобы он не потерял равновесие переместить его на место установки. (35)

ВНИМАНИЕ: никогда не перемещать холодильник в горизонтальном положении; это может повредить аппарат. (36)

ВНИМАНИЕ: как в момент установки так и или в следующих перемещениях холодильника, ни в коем случае не тащить и не толкать его, чтобы избежать перевертывания или повреждения. (37)

ВНИМАНИЕ: не оставлять холодильник вблизи источников тепла или в помещениях с повышенной температурой – это может повредить рефрижиратор или повлиять на его производительность. (38)

ВНИМАНИЕ: Придерживаться дистанции от потолка минимум 50см. Возможно ставить рядом аппараты, но только в случае формирования конденсации отстранить их друг от друга минимум на 2см.

Удалить защитную пленку с товара

Это операция может спровоцировать удар электрическим током, даже если это не опасно (статическое электричество).

Этого неприятного ощущения можно избежать, держась одной рукой за аппарат. (39)

После установки машины устранить защитную решетку деревянным молотком и столярским резцом, осторожно, чтобы не повредить ножек. (40)

Удалить укрепительные деревянные бруски с нижних отверстий. (41)

Труба-сифон сброса находится под аппаратом и должен соединяться непосредственно к сети канализации с открытым сбросом.

Труба питания (соединение 3/4") воды, находящаяся в верхней части аппарата должна быть подсоединена к водопроводной сети с помощью перехвачивающего клапана, фильтра в форме патрона и одностороннего клапана.

Температура воды питания должна быть между 5°C и 40°C.

Давление воды должно быть достаточно, чтобы гарантировать правильное функционирование аппарата (>1bar).

Если вода, использованная особенно загрязненная нечистотами, советуется использовать фильтры или очистители для её очищения.

Теперь можно регулировать ножки. (42)

Установить аппарат, держа его слегка наклоненным назад, чтобы помочь самозакрытию двери/ей. (43)
Вымыть аппарат водой с нейтральным моющим средством (как описано в параграфе «ЧИСТКА») и монтировать все внутренние части холодильника.

Аппарат оснащен штепсельной вилкой по типу SHUKO. Проконтролировать ее соответствие нормам EN60320 и национальным нормам. В случае несоответствия заменить вилку. (44)

ВНИМАНИЕ: операции должны производиться только специализированным специалистом. (30)

Проверить, что напряжение сети соответствует показателю, указанному на схеме технических характеристик холодильника. (45)

Подсоединить холодильник к сети. (46)

На этом установка и запуск в работу закончились.

Аппаратура должна быть, кроме того включена в эквипотенциальную систему, эффективность которой должна быть проверена действующими нормами. Соединение осуществляется при помощи винта отмеченного символом «Эквипотенциальный» установленной в компрессорной зоне. (47)

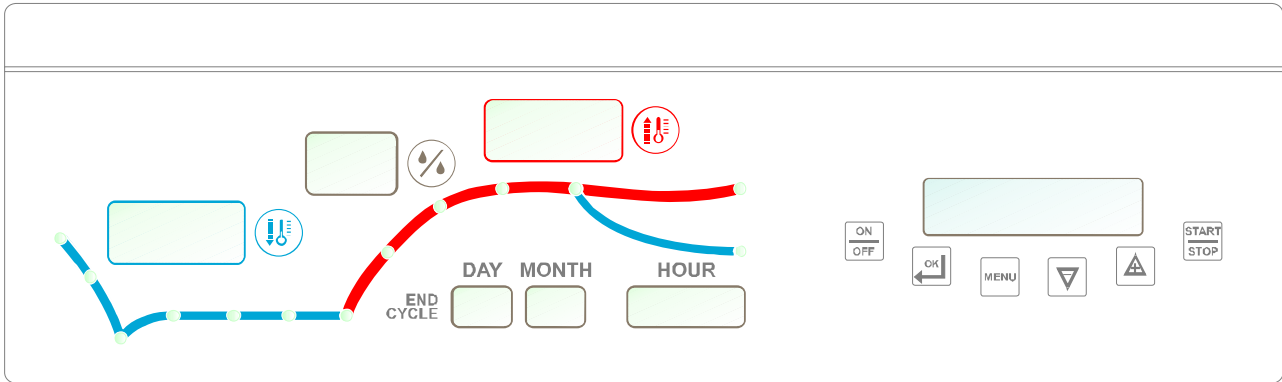

	<p><u>Кнопка ON/OFF</u> Держа нажатой кнопку 3сек контроллер гаснет и на дисплее появляется надпись . При последующем нажатии клавиши контроллер включается и визуализируется .</p>
	<p><u>Кнопка Enter</u> Позволяет ввойти в меню или выбрать параметр. <i>Нажатие на клавишу во время работы цикла позволяет визуализировать дату и время.</i></p>
	<p><u>Кнопка Menu</u> Позволяет ввойти в главное меню или вернуться в меню предыдущее.</p>
	<p><u>Кнопки Up и Down</u> Позволяют находить разные меню или изменять показатели параметров.</p>
	<p><u>Кнопку Start/Stop</u> Позволяет запустить/остановить цикл. Устройство в процессе паузы, При нажатии на клавишу и последующем удержании ее в течение 3 сек., автоматически запускается программа, соответствующая дню недели, в который осуществляется запуск.</p>
	<p>Визуализация температуры в камере во время фазы замораживания, сохранения или блокировка брожения.</p>
	<p>Показывает процент влажности в камере. <i>Включен во время выполнения фаз, для которых предусмотрен контроль влажности.</i></p>
	<p>Визуализация температуры в камере во время фазы размораживания, кондиционирования, брожения замедление или ускорение</p>
	<p>Указывают дату и время <i>Показывают день, месяц и реальное время, если карта находится в режиме ожидания (standby) или идет выполнение ручного цикла. Показывают день, месяц и время окончания цикла, если идет выполнение автоматического цикла.</i></p>

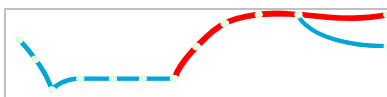

Показывает состояние продвижения выбранного цикла.
Светодиоды, соответствующие уже завершенным фазам, остаются включенными во время выполнения последующих фаз.

Карточка предусматривает возможность выставить циклы **автоматические** или произвести цикл **в ручную**.

Цикл в ручную: установка 3 фаз:
ЗАМОРАЖИВАНИЕ, РАЗМОРАЖИВАНИЕ И КОНДИЦИОНИРОВАНИЕ

Автоматические циклы: 7 циклов выставленных и/или изменяемых) составленных из следующих фаз:
БЛОКИРОВКА БРОЖЕНИЯ, СОХРАНЕНИЕ, УСКОРЕНИЕ БРОЖЕНИЯ И ЗАМЕДЛЕНИЕ

ЗАПУСК

Для запуска установки проделать следующие операции:

- вставить вилку в розетку питания; (50)
- поставить выключатель в позицию ON; (51)
- нажать кнопку  ;

На дисплее отображается

02/01/2009
Tue 17:35

ЗАГРУЗКА ПРОДУКТА

Начиная с этого момента возможно загружать в холодильник продукты питания.

- Располагать продукты в таком порядке, чтобы не препятствовать циркуляции воздуха.
- Запрещено закупоривать вентиляционные зоны внутри холодильника. Внутри рефрижераторных камер имеются индикаторы уровня загрузки решеток.
- Не оставлять двери открытыми на продолжительное время в процессе работы.
- Советуется держать ключи дальше от детей.







ФУНКЦИОНИРОВАНИЕ

РУЧНОЙ ЦИКЛ

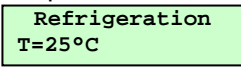





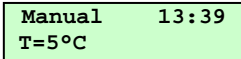





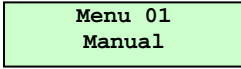

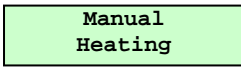
Ручной цикл состоит из 3 независимых фаз и переход от одной фазы к другой не автоматично.

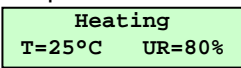
ФАЗА ЗАМОРАЖИВАНИЯ

	Нажать кнопку <i>menu</i> для выбора нужного меню
	Использовать кнопки <i>up</i> и <i>down</i> для визуализации 
	Нажать кнопку <i>enter</i> , чтобы подтвердить выбор
	Использовать кнопки <i>up</i> и <i>down</i> для визуализации 

	Нажать кнопку <i>enter</i> , чтобы подтвердить выбор. Визуализируется 
	Нажать клавишу <i>enter</i> для того, чтобы войти в режим изменения уставок (SetPoint). <i>Значение уставки (SetPoint) Температура мигает, использовать клавиши  и  для изменения значения</i>
	Нажать клавишу <i>enter</i> для подтверждения нового значения
	Нажать клавишу <i>start/stop</i> для мгновенного запуска выбранной фазы. Визуализируется 

ФАЗА НАГРЕВА

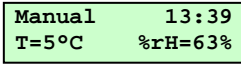
	Нажать кнопку <i>menu</i> для выбора нужного меню
	Использовать кнопки <i>up</i> и <i>down</i> для визуализации 
	Нажать кнопку <i>enter</i> , чтобы подтвердить выбор
	Использовать кнопки <i>up</i> и <i>down</i> для визуализации 
	Нажать кнопку <i>enter</i> , чтобы подтвердить выбор. Визуализируется 
	Нажать клавишу <i>enter</i> для того, чтобы войти в режим изменения уставок (SetPoint). <i>Значение уставки (SetPoint) Температура мигает, использовать клавиши  и  для изменения значения</i>
	Нажать клавишу <i>enter</i> для подтверждения нового значения. <i>Значение уставки (SetPoint) Влажность мигает, использовать клавиши  и  для изменения значения</i>
	Нажать клавишу <i>enter</i> для подтверждения нового значения
	Нажать клавишу <i>start/stop</i> для мгновенного запуска выбранной фазы. Визуализируется 

ФАЗА КОНДИЦИОНИРОВАНИЯ

	Нажать кнопку <i>menu</i> для выбора нужного меню
---	---

 	Использовать кнопки <u>up</u> и <u>down</u> для визуализации	Menu 01 Manual
	Нажать кнопку <u>enter</u> , чтобы подтвердить выбор	
 	Использовать кнопки <u>up</u> и <u>down</u> для визуализации	Manual Air Con
	Нажать кнопку <u>enter</u> , чтобы подтвердить выбор. Визуализируется	Air Con T=25°C UR=80%
	Нажать клавишу <u>enter</u> для того, чтобы войти в режим изменения уставок (SetPoint). Значение уставки (SetPoint) Температура мигает, использовать клавиши  и  для изменения значения	
	Нажать клавишу <u>enter</u> для подтверждения нового значения. Значение уставки (SetPoint) Влажность мигает, использовать клавиши  и  для изменения значения	
	Нажать клавишу <u>enter</u> для подтверждения нового значения	
	Нажать клавишу <u>start/stop</u> для мгновенного запуска выбранной фазы. Визуализируется	Manual 13:39 T=5°C %rH=63%

АВТОМАТИЧЕСКИЙ ЦИКЛ

Электрическая карточка имеет в памяти 7 автоматических циклов, как показано ниже

УСТРОЙСТВА -5°C / +30°C

ЦИКЛ		P1	P2	P3	P4	P5	P6	P7
		Понедельник	Вторник	Среда	Четверг	Пятница	Суббота	Воскресенье
ОСТАНОВКА	Продолжительность	02:00	02:00	02:00	02:00	02:00	02:00	02:00
	Температура	-5°C	-5°C	-5°C	-5°C	-5°C	-5°C	-5°C
СОХРАНЕНИЕ	Температура	-1°C	-1°C	-1°C	-1°C	-1°C	-1°C	-1°C
АКТИВИЗАЦИЯ	Продолжительность	02:00	02:00	02:00	02:00	02:00	02:00	02:00
	Температура	20°C	20°C	20°C	20°C	20°C	20°C	20°C
	Влажность	70%	70%	70%	70%	70%	70%	70%
БРОЖЕНИЕ	Продолжительность	02:00	02:00	02:00	02:00	02:00	02:00	02:00
	Температура	28°C	28°C	28°C	28°C	28°C	28°C	28°C
	Влажность	80%	80%	80%	80%	80%	80%	80%
ЗАВЕРШЕНИЕ ПРОГРАММЫ	Время	01:00	01:00	01:00	01:00	01:00	01:00	01:00
ОСТАНОВКА	Температура	6°C	6°C	6°C	6°C	6°C	6°C	6°C
	Влажность	80%	80%	80%	80%	80%	80%	80%

УСТРОЙСТВА -18°C / +30°C

ЦИКЛ		P1	P2	P3	P4	P5	P6	P7
		Понедельник	Вторник	Среда	Четверг	Пятница	Суббота	Воскресенье
ОСТАНОВКА	Продолжительность	02:00	02:00	02:00	02:00	02:00	02:00	02:00
	Температура	-20°C	-20°C	-20°C	-20°C	-20°C	-20°C	-20°C
СОХРАНЕНИЕ	Температура	-1°C	-1°C	-1°C	-1°C	-1°C	-1°C	-1°C

АКТИВИЗАЦИЯ	Продолжительность	02:00	02:00	02:00	02:00	02:00	02:00	02:00
	Температура	20°C	20°C	20°C	20°C	20°C	20°C	20°C
	Влажность	70%	70%	70%	70%	70%	70%	70%
БРОЖЕНИЕ	Продолжительность	02:00	02:00	02:00	02:00	02:00	02:00	02:00
	Температура	28°C	28°C	28°C	28°C	28°C	28°C	28°C
	Влажность	80%	80%	80%	80%	80%	80%	80%
ЗАВЕРШЕНИЕ ПРОГРАММЫ	Время	01:00	01:00	01:00	01:00	01:00	01:00	01:00
ОСТАНОВКА	Температура	6°C	6°C	6°C	6°C	6°C	6°C	6°C
	Влажность	80%	80%	80%	80%	80%	80%	80%







УСТРОЙСТВА -2°C / +30°C

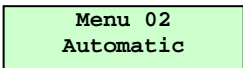

ЦИКЛ		P1	P2	P3	P4	P5	P6	P7
		Понедельник	Вторник	Среда	Четверг	Пятница	Суббота	Воскресенье
ОСТАНОВКА	Продолжительность	02:00	02:00	02:00	02:00	02:00	02:00	02:00
	Температура	-2°C	-2°C	-2°C	-2°C	-2°C	-2°C	-2°C
СОХРАНЕНИЕ	Температура	+2°C	+2°C	+2°C	+2°C	+2°C	+2°C	+2°C
АКТИВИЗАЦИЯ	Продолжительность	02:00	02:00	02:00	02:00	02:00	02:00	02:00
	Температура	20°C	20°C	20°C	20°C	20°C	20°C	20°C
	Влажность	70%	70%	70%	70%	70%	70%	70%
БРОЖЕНИЕ	Продолжительность	02:00	02:00	02:00	02:00	02:00	02:00	02:00
	Температура	28°C	28°C	28°C	28°C	28°C	28°C	28°C
	Влажность	80%	80%	80%	80%	80%	80%	80%
ЗАВЕРШЕНИЕ ПРОГРАММЫ	Время	01:00	01:00	01:00	01:00	01:00	01:00	01:00
ОСТАНОВКА	Температура	6°C	6°C	6°C	6°C	6°C	6°C	6°C
	Влажность	80%	80%	80%	80%	80%	80%	80%

*Примечание: Максимальная температура теста 27°C – мука vхх 320 – увеличить на 0,01 дрожжи – увеличить на 0,01 соль для соленых продуктов или сахара для сладких продуктов.

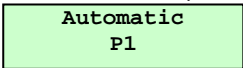
Каждый из автоматических циклов состоит из 5 пяти фаз.

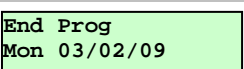











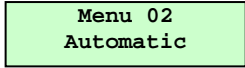

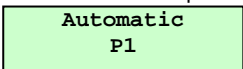







Цикл начинается всегда с фазы **БЛОКИРОВКА БРОЖЕНИЯ** и приступает к следующим **автоматически** на основе длительности отдельной фазы и времени до конца выставленного цикла.

	Нажать кнопку <u>menu</u> для выбора нужного меню	
	Использовать кнопки <u>up</u> и <u>down</u> для визуализации	
	Нажать кнопку <u>enter</u> , чтобы войти в секцию программ, уже внесённых в память (P01... P07). Визуализируется	
	Использовать клавиши <u>up</u> и <u>down</u> для выбора желаемой программы	
	Нажать кнопку <u>enter</u> . Визуализируется	

Если указанная дата окончания соответствует желаемой, нажать клавишу , для подтверждения и запуска выполнения цикла, в противном случае нажать клавишу  для изменения даты завершения цикла.

ИЗМЕНЕНИЕ АВТОМАТИЧЕСКОГО ЦИКЛА



Чтобы изменять циклы преждевременно выставленные проделать следующие инструкции.

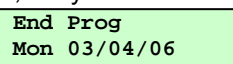

	Нажать кнопку <u>menu</u> для выбора нужного меню
	Использовать кнопки <u>up</u> и <u>down</u> для визуализации 
	Нажать кнопку <u>enter</u> , чтобы войти в секцию программ, уже внесённых в память (P01... P07). Визуализируется 
	Использовать клавиши <u>up</u> и <u>down</u> для выбора желаемой программы
	Нажать клавишу <u>enter</u> для того, чтобы войти в режим установки выбранной программы
	Используя клавишу <u>down</u> , можно переходить от одной фазы к другой, при этом на дисплее будет отображаться фаза цикла с текущими значениями уставок (setpoint)
	Нажать клавишу <u>enter</u> для входа в режим изменения. Значение Часы начинает мигать. Использовать клавиши  и  для изменения значения.
	Нажать клавишу <u>enter</u> для подтверждения нового значения, значение больше не мигает. Значение Минуты начинает мигать. Использовать клавиши  и  для изменения значения.
	Нажать клавишу <u>enter</u> для подтверждения нового значения, значение больше не мигает. Значение уставки (SetPoint) Температура становится мигающим. Использовать клавиши  и  для изменения значения.
	Нажать клавишу <u>enter</u> для подтверждения нового значения, значение больше не мигает. Значение уставки (SetPoint) Влажность становится мигающим (если имеется). Использовать клавиши  и  для изменения значения.
	Нажать клавишу <u>enter</u> для подтверждения нового значения, значение больше не мигает. Использовать клавиши  и  для выбора других фаз и изменения их уставок (Setpoint).

Нажатие клавиши  позволяет запомнить программу и вернуться в предыдущее меню.

Нажатие клавиши  позволяет, напротив, запустить выполнение программы, на дисплее отображается дата завершения цикла.



Если указанная дата окончания соответствует желаемой, нажать клавишу , для подтверждения и запуска выполнения цикла, в противном случае нажать клавишу  для изменения даты завершения цикла.

Значение дня мигает, при помощи клавиши  переставить дату завершения программы, нажать клавишу  для подтверждения новой даты и нажать клавишу  для запуска выполнения цикла.

ВЫПОЛНЕНИЕ АВТОМАТИЧЕСКОГО ЦИКЛА

Во время выполнения автоматического цикла на дисплее отображаются:

P2 Locking
T=19°C

Номер выполняемой программы, выполняемая фаза, фактическая температура в камере и, если в фазе предусмотрено также увлажнение с помощью зонда, отображается текущее значение влажности в процентах.

Визуализировать дату и время фаз

Нажать клавишу  для визуализации даты и времени окончания выполняемой фазы

Нажать клавишу  для визуализации даты и времени окончания последующих фаз.

Визуализируется

End PH 0 09:00
Mon 03/04/09

Где PH0 показывает, что выполняется фаза 0 программы, точнее фаза Блокировки.

Другие фазы обозначаются так:

PH1 обозначает Сохранение

PH2 означает Активизация

PH3 означает Брожение

PH4 означает Замедление

Нажатие клавиши , или таймаут 5 секунд, воспроизводят предыдущую визуализацию.

Визуализировать состояние INPUT/OUTPUT

Нажать клавишу  для визуализации состояния INPUT/OUTPUT.

C D E R V H U
1 0 0 1 1 0 0

Нажатие клавиши , или таймаут 20 секунд, воспроизводят предыдущую визуализацию.

Визуализировать дату и время

Нажать клавишу  для визуализации даты и времени.







08/02/2007
Tue 17:35

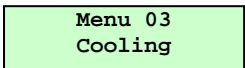

Нажатие клавиши , или таймаут 5 секунд, воспроизводят предыдущую визуализацию.

В любой момент времени нажатие клавиши  останавливает выполнение цикла. Цикл, тем не менее, остается выбранным.

ЦИКЛ ОХЛАЖДЕНИЯ

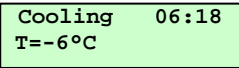

До выбора любого цикла, рекомендуется сначала запустить цикл охлаждения.

	Нажать кнопку <i>menu</i> для выбора нужного меню
 	Использовать кнопки <i>up</i> и <i>down</i> для визуализации 
	Нажать клавишу <i>enter</i> для того, чтобы войти в режим изменения уставок (SetPoint). Значение уставки (SetPoint) Температура мигает, использовать клавиши  и  для изменения значения.

	Нажать клавишу <u>enter</u> для подтверждения нового значения
	Нажать кнопку <u>start/stop</u> для немедленной активизации цикла охлаждения Визуализируется 

Нажатием клавиши  можно вернуться к изменению уставок (SetPoint).





ОСТАНОВКА

При любых условиях, чтобы остановить аппарат достаточно нажать клавишу  ;
на дисплее отображается 

ВНИМАНИЕ: клавиша  НЕ изолирует аппарат от электрического напряжения.

Чтобы изолировать аппарат от электрического напряжения вытащить вилку с розетки. (17)

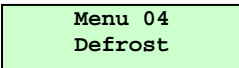

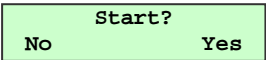





РАЗМОРАЖИВАНИЕ

	Нажать кнопку <u>menu</u> для выбора нужного меню
	Использовать кнопки <u>up</u> и <u>down</u> для визуализации 
	Нажать кнопку <u>enter</u> , чтобы войти в порядок запроса на start размораживания Визуализируется 

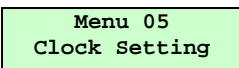
Нажать клавишу  для выхода из меню и размораживание не будет запущено.

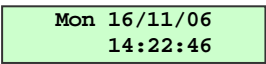

Нажать клавишу  для запуска размораживания.

УСТАНОВКА ЧАСОВ

	Нажать кнопку <u>menu</u> для выбора нужного меню
	Использовать кнопки <u>up</u> и <u>down</u> для визуализации 
	Нажать кнопку <u>enter</u> , чтобы войти в порядок установки времени. Визуализируется  Использовать клавиши  и  для изменения значения мигающей цифры.
	Нажимать на клавишу <u>enter</u> , чтобы подтвердить показатель и перейти к следующим данным

	Нажать кнопку <u>menu</u> чтобы выйти из выбора
--	---

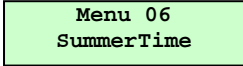
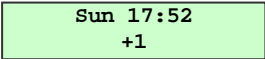
УСТАНОВКА ДЕКРЕТНОГО ВРЕМЕНИ

	Нажать кнопку <u>menu</u> для выбора нужного меню
	Использовать кнопки <u>up</u> и <u>down</u> для визуализации 
	Нажать клавишу <u>enter</u> для входа в режим установки декретного времени. Визуализируется  Использовать клавиши  и  для изменения времени.
	Нажать клавишу <u>enter</u> для подтверждения нового значения
	Нажать кнопку <u>menu</u> чтобы выйти из выбора

ЯЗЫК

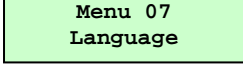
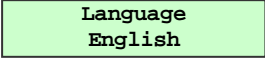
	Нажать кнопку <u>menu</u> для выбора нужного меню
	Использовать кнопки <u>up</u> и <u>down</u> для визуализации 
	Нажать клавишу <u>enter</u> для визуализации используемого в данный момент языка. Визуализируется 
	Использовать кнопки <u>up</u> и <u>down</u> для визуализации желаемого языка
	Нажать кнопку <u>enter</u> , чтобы подтвердить выбор
	Нажать кнопку <u>menu</u> чтобы выйти из выбора

ПАРАМЕТРОВ

ИЗМЕНЕНИЕ ПАРАМЕТРОВ

	Нажать кнопку <i>menu</i> для выбора нужного меню
	Использовать кнопки <i>up</i> и <i>down</i> для визуализации 
	Нажать кнопку <i>enter</i> , чтобы подтвердить выбор. Визуализируется 
	Использовать кнопки <i>up</i> и <i>down</i> для выбора пароля "-19"
	Нажать кнопку <i>enter</i> , чтобы подтвердить выбор. Отображается первое подменю 
	Нажать кнопку <i>enter</i> , чтобы войти в порядок установки параметров Визуализируется первый параметр 
	Использовать клавиши <i>up</i> и <i>down</i> , чтобы просмотреть все параметры контроллера
	Нажать кнопку <i>enter</i> , чтобы подтвердить выбор
	Пользоваться клавишами <i>up</i> и <i>down</i> , чтобы отобразить новый показатель параметра
	Нажать кнопку <i>enter</i> , чтобы подтвердить выбор
	Нажать кнопку <i>menu</i> чтобы вернуться в Главное Меню

ОПИСАНИЕ ПАРАМЕТРОВ

№	Описание	Default -2/+30°C	Default -5/+30°C	Default -18/+30°C	Min	Max	Единица
Основные конфигурации							
P1	Выбор визуализации включения питания (power on) 0 = отсутствует 1 = EVCO s.r.l.	1	1	1	0	1	---
P2	0 = Celsius 1 = Fahrenheit	0	0	0	0	1	---
P3	Offset зонда ячейки	0	-2	-2	-15	15	°C/°F
P4	Ошибка зонда испарителя	0	0	0	-15	15	°C/°F
P5	Верхний предел зонда увлажнения	0	0	0	0	P6	%
P6	Нижний предел зонда увлажнения	100	100	100	P5	200	%

№	Описание	Default -2/+30°C	Default -5/+30°C	Default -18/+30°C	Min	Max	Единица
P7	Полярность входа для контакта двери 0 = НЕТ 1 = NC	0	0	0	0	1	---
P8	Полярность входа ВТ для термостата 0 = НЕТ 1 = NC	0	0	0	0	1	---
P9	Длительность выключения питания (Power down) во время восстановления автоматической программы	15	15	15	1	60	минуты
P10	Выбор режима работы после выключения питания (power down) при автоматической программе 0 = автоматический цикл возобновляется, только если выключение питания (power down) меньше P9 минут 1 = автоматический цикл возобновляется всегда	1	1	1	1	1	---
P11	Длительность выключения питания (Power down) во время восстановления ручной программы	15	15	15	1	60	минуты
P12	Выбор режима работы после выключения питания (power down) при ручной программе 0 = ручной цикл возобновляется, только если выключение питания (power down) меньше P11 минут 1 = ручной цикл возобновляется всегда	1	1	1	0	1	---
Setpoint							
P13	Мин setpoint устанавливается холод	-2	-5	-24	-30	P14	°C/°F
P14	Макс setpoint устанавливается холод	10	10	5	P13	90	°C/°F
P15	запаздывание холода	2	2	2	1	10	°C/°F
P16	Мертвая зона холода для замораживания, остановки и сохранения	0	0	0	0	10	°C/°F
P17	Мертвая зона холода для нагрева, активизации и брожения	0	0	0	0	10	°C/°F
P18	Мертвая зона холода для климатизации и замедления	0	0	0	0	10	°C/°F
P19	Мин setpoint устанавливается тепло	5	5	5	0	P20	°C/°F
P20	Макс setpoint устанавливается тепло	30	30	30	P19	90	°C/°F
P21	запаздывание тепла	1	1	1	1	10	°C/°F
P22	Мертвая зона тепла для нагрева, активизации и брожения	1	1	1	0	10	°C/°F
P23	Мертвая зона тепла для климатизации и замедления	1	1	1	0	10	°C/°F
P24	Номер шагов регулирования сопротивления при пробуждении	9	9	9	1	10	---
P25	Номер шагов регулирования сопротивления при брожении	1	1	1	1	10	---
Временные режимы Компрессора							
P26	Замедление между двумя последующими оп компрессора	3	3	3	0	60	минуты
P27	Замедление между off и последующим оп компрессора	2	2	2	0	60	минуты
P28	Замедление запуска компрессора с power on	1	1	1	0	255	минуты
P29	Продолжительность принудительного запуска компрессора в начале выполнения фаз активизации, брожения и замедления	0	0	0	0	60	минуты
Временные режимы электрических нагревательных элементов							
P30	Минимальное время активации электрических нагревательных элементов	0	0	0	0	255	секунды
Увлажнение и Обезвоживание							
P31	Нижний предел температуры для увлажнения/обезвоживания	5	5	5	0	90	°C/°F
P32	Порядок управления влажности 0 = с зондом влажности 1 = по циклам времени на основе процентного отношения выставлена 2 = шагами в минуту	0	0	0	0	2	---
P33	Время паузы, если P32 = 2	10	10	10	0	60	минуты
P34	Продолжительность цикла увлажнения, если P32 = 1	60	60	60	30	600	секунды
P35	Максимальное время увлажнения, если P32 = 1	30	30	30	0	P34	секунды
P36	Поключает увлажнение в фазах остановки брожения и сохранения 0 = отключено 1 = подключено	0	0	0	0	1	---
P37	Запоздание при увлажнении	1	1	1	1	100	%
P38	Мёртвая зона при увлажнении	4	4	4	0	100	%
P39	Диапазон Пропорционального Регулирования Влажности	4	4	4	0	20	%
P40	Время цикла Пропорционального Регулирования Влажности	1	1	1	1	255	секунды/ минуты
P41	Временной базис для Времени Цикла 0 = секунды 1 = минуты	1	1	1	0	1	---

№	Описание	Default -2/+30°C	Default -5/+30°C	Default -18/+30°C	Min	Max	Единица
P42	Запоздание при высушивании	1	1	1	1	100	%
P43	Мёртвая зона при высушивании	5	5	5	0	100	%
P44	Продолжительность Попытки Обезвоживания при помощи электроклапана	1	1	1	1	255	секунды
Вентиляция							
P45	Подключение Пропорционального Регулирования Вентиляторов Испарителя 0 = регуляция ON/OFF 1 = пропорциональная регуляция	0	0	0	0	1	---
P46	Функционирование вентиляторов испарителя на блок брожение 0 = функционирование в параллели 1 = непрерывное функционирование	1	1	1	0	1	---
P47	Функционирование вентиляторов испарителя на сохранение 0 = функционирование в параллели 1 = непрерывное функционирование	1	1	1	0	1	---
P48	Функционирование вентиляторов испарителя на пробуждение 0 = функционирование в параллели 1 = непрерывное функционирование	0	0	0	0	1	---
P49	Функционирование вентиляторов испарителя на Брожение 0 = функционирование в параллели 1 = непрерывное функционирование	0	0	0	0	1	---
P50	Функционирование вентиляторов испарителя на замедление функционирование в параллели 1 = непрерывное функционирование	0	0	0	0	1	---
P51	Функционирование вентиляторов испарителя на охлаждение 0 = функционирование в параллели 1 = непрерывное функционирование	1	1	1	0	1	---
P52	Функционирование вентиляторов испарителя на нагревание 0 = функционирование в параллели 1 = непрерывное функционирование	0	0	0	0	1	---
P53	Функционирование вентиляторов для кондиционирования 0 = функционирование в параллели 1 = непрерывное функционирование	0	0	0	0	1	---
P54	Ritardo disattivazione ventilatori evaporatore in funzionamento in parallelo	1	1	1	0	255	минуты
P55	Время работы вентиляторов испарителя при параллельном функционировании.	1	1	1	0	255	минуты
P56	Время паузы вентиляторов испарителя, если функционирование в параллели	1	1	1	0	255	минуты
P57	Минимальная Скорость Вентиляторов Испарителя	0	0	0	0	P58	%
P58	Максимальная Скорость Вентиляторов Испарителя	100	100	100	P57	100	%
P59	Минимальная скорость Вентиляторов Испарителя во время обезвоживания	20	20	20	P57	P58	%
Размораживание							
P60	Температура Испарителя в конце размораживания	8	8	8	-40	99	°C
P61	Интервал между двумя последующими размораживаниями 0 = размораживание не повторится	8	8	6	0	10	Часы
P62	Максимальная продолжительность размораживания	10	10	30	1	120	минуты
P63	Время стекания	2	2	3	0	30	минуты
P64	Состояние вентилятора во время размораживания	0	0	0	0	1	---
P65	Продолжительность блокировки вентилятора после стекания	2	2	2	0	15	минуты
Охлаждение							
P66	Минимальная уставка (Setpoint) для Охлаждения	-2	-5	-5	-30	P67	°C
P67	Максимальная уставка (Setpoint) для Охлаждения	10	10	10	P66	30	°C
P68	Предварительно заданное Охлаждение	-2	-5	-5	P66	P67	°C
Установка и Изменение Программ							
P69	Подключение Установки Программ	1	1	1	0	1	---
P70	Подключение Изменения Программ	1	1	1	0	1	---
P71	Управление КЗ: 0=Электроклапан; 1= Освещение; 2= Обезвоживание	1	1	1	0	2	---
P72	Управление Компрессором при Открытой Двери: 0 = действие отсутствует; 1= включает компрессор	0	0	0	0	1	---
P73	Тип размораживания: 0 = Электрический нагревательный элемент; 1 = Горячий Газ	0	0	0	0	1	---

№	Описание	Default -2/+30°C	Default -5/+30°C	Default -18/+30°C	Min	Max	Единица
P74	Сигнал тревоги при высокой температуре Испарителя	55	55	55	0	70	°C
P75	Подключает сигнал тревоги при высокой температуре Испарителя: 0 = не подключен; 1 = подключен	1	1	1	0	1	---
P76	Подключение Обезвоживания 0= не подключено 1= подключено в фазах Активизации, Брожения, Замедления, Климатизации, Нагрева 2 = подключена так же в фазах Остановки и Сохранения	0	0	0	0	2	---
P77	Время Нагрева ON	3	3	3	1	255	секунды/ минуты
P78	Время Нагрева OFF (0= нагревательные элементы всегда включены)	1	1	1	0	255	секунды/ минуты









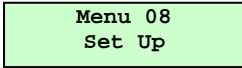

Заметка

- Контролировать время защиты компрессора, так как по умолчанию установлены нули.
- Параметры P5 и P6 используются чтобы определить тип зонда влажности. Параметр P5 должен быть расположен также как и процентное отношение влажности, соответствующей 4mA и параметру P6 должен быть расположен также как и процентное отношение влажности, соответствующей 20mA.
- После изменения параметра P32 проверить, чтобы setpoint влажности автоматических программ и ручных

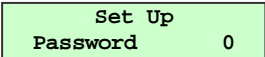
ВХОДЫ И ВЫХОДЫ

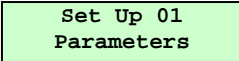
	Нажать кнопку <u>menu</u> для выбора нужного меню																
	Использовать кнопки <u>up</u> и <u>down</u> для визуализации 																
	Нажать кнопку <u>enter</u> , чтобы подтвердить выбор. Визуализируется 																
	Использовать кнопки <u>up</u> и <u>down</u> для выбора пароля "-19"																
	Нажать кнопку <u>enter</u> , чтобы подтвердить выбор. Отображается первое подменю 																
	Использовать кнопки <u>up</u> и <u>down</u> для визуализации 																
	Нажать кнопку <u>enter</u> , чтобы войти в процедуру визуализации входов и выходов Визуализируется 																
	Использовать клавиши <u>up</u> и <u>down</u> для просмотра визуализируемых величин  Показатель температуры ячейки и испарителя  Значение зонда Влажности  Состояние выходов 1 = реле активизировано 0 = реле деактивизировано  Состояние цифровых входов и скорость вентилятора испарителя <table border="1" data-bbox="1046 1749 1441 1868"> <tr> <td>C</td> <td>Компрессор</td> <td>V</td> <td>Вентиляторы</td> </tr> <tr> <td>D</td> <td>Размораживание</td> <td>H</td> <td>Ген. пара</td> </tr> <tr> <td>EV</td> <td>Освещение</td> <td>U</td> <td>Увлажнитель</td> </tr> <tr> <td>R</td> <td>Электрические нагревательные элементы</td> <td></td> <td></td> </tr> </table>	C	Компрессор	V	Вентиляторы	D	Размораживание	H	Ген. пара	EV	Освещение	U	Увлажнитель	R	Электрические нагревательные элементы		
C	Компрессор	V	Вентиляторы														
D	Размораживание	H	Ген. пара														
EV	Освещение	U	Увлажнитель														
R	Электрические нагревательные элементы																
	Нажать кнопку <u>menu</u> чтобы вернуться в Главное Меню																

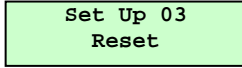
ВОССТАНОВЛЕНИЯ ПАРАМЕТРОВ ПО УМОЛЧАНИЮ









	Нажать кнопку <i>menu</i> для выбора нужного меню
	Использовать кнопки <i>up</i> и <i>down</i> для визуализации 
	Нажать кнопку <i>enter</i> , чтобы подтвердить выбор. Визуализируется 
	Использовать кнопки <i>up</i> и <i>down</i> для выбора пароля “-19”
	Нажать кнопку <i>enter</i> , чтобы подтвердить выбор. Отображается первое подменю 
	Использовать кнопки <i>up</i> и <i>down</i> для визуализации 
	Нажать клавишу <i>enter</i> для входа на запрос вычёркивание зарегистрированных данных в памяти. Визуализируется 



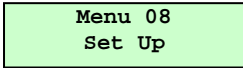

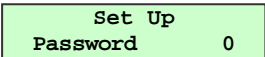

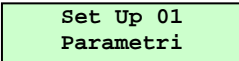
Нажать клавишу  для выхода из меню без выполнения восстановления.

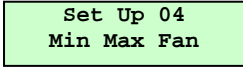
Нажать клавишу  для восстановления параметров, которые были заданы по умолчанию.

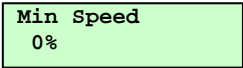
Нажать кнопку  чтобы вернуться в Главное Меню

РЕГУЛИРОВКИ СКОРОСТИ ВЕНТИЛЯТОРОВ

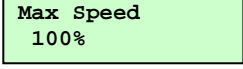
	Нажать кнопку <i>menu</i> для выбора нужного меню
	Использовать кнопки <i>up</i> и <i>down</i> для визуализации 
	Нажать кнопку <i>enter</i> , чтобы подтвердить выбор. Визуализируется 
	Использовать кнопки <i>up</i> и <i>down</i> для выбора пароля “-19”
	Нажать кнопку <i>enter</i> , чтобы подтвердить выбор. Отображается первое подменю 
	Использовать кнопки <i>up</i> и <i>down</i> для визуализации 

	Нажать клавишу <u>enter</u> для входа в режим регулировки скорости вентиляторов. Визуализируется 
	Нажать клавишу <u>enter</u> для входа в режим изменения. Значение становится мигающим. Использовать клавиши  и  для изменения значения.
	Нажать клавишу <u>enter</u> для подтверждения нового значения. Визуализируется 
	Нажать клавишу <u>enter</u> для подтверждения нового значения.
	Нажать кнопку <u>menu</u> чтобы вернуться в Главное Меню

СИГНАЛИЗАЦИИ

В случае возникновения отказов предусмотрены визуальные и звуковые сигналы.

Зонд Камеры

Повреждение зонда вызывает Аварийный Сигнал Зонда Камеры, раздается сигнал зуммера и на дисплее возникает мигающее сообщение об ошибке:

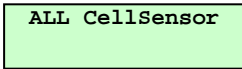

Любой текущий цикл будет остановлен и все действия прекращены.

Зуммер можно выключить, нажав любую клавишу.

После исчезновения ошибки цикл возобновляется.

Термостат безопасности

Когда карта получает сигнал тревоги Термостата, раздается сигнал зуммера и на дисплее появляется визуальное отображение аварийного сигнала:

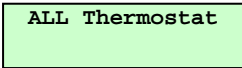

Любой текущий цикл будет остановлен и все действия прекращены.

Зуммер можно выключить, нажав любую клавишу.

После исчезновения ошибки нажать клавишу  для перезагрузки карты.

Зонд испарителя

Повреждение зонда вызывает Аварийный Сигнал Зонда Испарителя, раздается сигнал зуммера и на дисплее возникает мигающее аварийное сообщение:

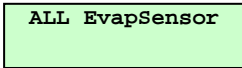

Любой текущий цикл будет остановлен и все действия прекращены.

Зуммер можно выключить, нажав любую клавишу.

После исчезновения ошибки цикл возобновляется.

Высокая температура Испарителя

Когда Зонд Испарителя достигает значения, установленного параметром P74, активируется аварийный сигнал высокой температуры Испарителя. Раздается сигнал зуммера и на дисплее возникает мигающее аварийное сообщение:

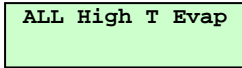

Любой текущий цикл будет остановлен и все действия прекращены.

Зуммер можно выключить, нажав любую клавишу.

После исчезновения ошибки нажать клавишу  для перезагрузки карты.

Зонд Влажности

Повреждение зонда вызывает Аварийный Сигнал Зонда Влажности, раздается сигнал зуммера и на дисплее возникает мигающее аварийное сообщение:

ALL HumSensor

Любой текущий цикл будет остановлен и все действия прекращены.

Зуммер можно выключить, нажав любую клавишу.

После исчезновения ошибки цикл возобновляется.

Микродатчик Двери

О каждом открытии двери будет предупреждать мигающая надпись Дверь Открыта:

Door Open

Открытие двери во время цикла выемки прерывает работу Вентиляторов, Электрических Нагревательных Элементов и Увлажнителя; Компрессор и Генератор Пара остаются включенными. Раздается сигнал зуммера, который можно выключить нажатием любой клавиши, аварийное сообщение исчезает после закрытия двери.

При каждом открытии Двери включается Освещение.

Отказ RTC

В случае, если возникает отказ RTC, подается аварийный сигнал RTC; раздается сигнал зуммера и на дисплее возникает мигающее аварийное сообщение:

ALL RTC

Любой текущий цикл будет остановлен и все действия прекращены.

Зуммер можно выключить, нажав любую клавишу.

Можно войти в Меню установка Часов и задать текущие значения RTC; после чего карта возвращается в режим ожидания (standby).

Аварийный сигнал EEPROM

В случае несогласованности данных в запоминающем устройстве Eeprom, подается аварийный сигнал Eeprom; раздается сигнал зуммера и на дисплее возникает мигающее аварийное сообщение:

ALL EEprom

Любой текущий цикл будет остановлен и все действия прекращены.

Зуммер можно выключить, нажав любую клавишу.

Для перезагрузки карты нажать клавишу . После перезагрузки карта возвращается в режим ожидания (standby).

NB: после аварийного сигнала Eeprom восстанавливаются значения всех параметров по умолчанию.

ВОЗМОЖНЫЕ ПОЛОМКИ ПРИ ЭКСПЛУАТАЦИИ

В случае поломки, до того как сообщать в техобслуживание, проконтролировать, что:

генеральный выключатель(1) светиться и в сети есть электричество; (63)

показатель температуры выставлен на желаемую температуру; (65)

двери плотно закрыты;

аппарат не находится вблизи тепла; (38)

конденсатор чистый и вентилятор работает регулярно;

нету чрезвычайного инея на батарее испарителя.

В случае, если эти проверки имели негативные показатели, обратиться в техобслуживание, указывая всю информацию о модели, номер и серию паспорта, находящихся на технической табличке, установленной на щитке аппарата.

ЕЖЕДНЕВНАЯ ЧИСТКА

Чтобы гарантировать безукоризненную гигиену и сохранение агрегата (66) необходимо осуществлять периодические и/или ежедневные операции по уходу, следуя инструкциям:

Тщательно мыть внешние поверхности аппарата, используя мягкую мочалку, намоченную в нейтральном моющем средстве, и хорошо выжатую, только в направлении сатинатуры.

Моющее средство не должно содержать хлор и других царапающих веществ. (67)

Рекомендуются моющие средства следующих типов:

Дезинфицирующие моющие средства комбинированного действия; (содержащие вещества, которые понижают напряжение воды, не ионизированные, хлористый натрий, вещества с нейтральной кислотностью)
Лабораторные моющие средства, нейтральные, для ручной чистки; (содержащие вещества, которые понижают напряжение воды, смягчающие её)

Пищевые растворители; (содержащие вещества, которые понижают напряжение воды, вещества содержащие неоны негативно заряженные)

Перед использованием растворить желаемое моющее средство, придерживаясь инструкций содержащихся на этикетке.

Оставить на 5 минут, чтобы произошла реакция.

Тщательно прополоскать стенки агрегата мочалкой, полоская её часто в проточной воде. (69)

Добросовестно высушить, пользуясь чистой мочалкой.

ВНИМАНИЕ :запрещено пользоваться веществами и предметами, которые могут повредить поверхность, вызывая этим ржавчину.(68)

Устранить возможное присутствие внутри аппарата пятен от пищи или отходов (смотрите следующий параграф).

ПИЩЕВЫЕ ПЯТНА И ЗАСОХШИЕ ПИЩЕВЫЕ ОСТАТКИ

В случае пятен от пищевых продуктов и остатков пищи в агрегатах вымыть их водой и удалить до того, как они засохнут.

И в максимальной гигиене продукты.

Если остатки пищи уже засохли следовать следующим образом:

Тщательно мыть поверхности агрегата, используя мягкую мочалку и тёплую воду с нейтральным моющим средством (можно использовать средства предназначенные для ежедневного ухода, применяя двойную концентрацию). (72)

Замочить засохшее пятно минимум на 30 минут, смачивая каждые 5 минут намыленной мочалкой, чтобы лучше размочить засохшую пищу.

Когда пятно будет полностью размочено, удалить его мочалкой, намоченной тёплой водой.

Необходимо пользоваться деревянной лопаточкой, быть осторожным, чтобы не пошкрябать поверхность агрегата. (70)

В конце процедуры советуется произвести цикл дневной чистки всех внутренних поверхностей.

В конце тщательно прополоскать чистой мочалкой несколько раз, ополаскивая её в проточной воде.

Вытереть чистой мочалкой до суха.

И зоны плохо доступные должны поддерживаться в чистоте и гигиене.

Мыть с водой и нейтральными моющими средствами. (71)

Чтобы защитить от ржавчины решётки смазывать их силиконовым воском.

ЧИСТКА И ПЕРИОДИЧЕСКОЕ ТЕХНИЧЕСКОЕ ОБСЛУЖИВАНИЕ

Для постоянной отдачи приспособления хорошо исполнять операции по чистке и периодическому техническому обслуживанию.

Перед тем как начать операции следуйте следующему:
перевести генеральный выключатель в позицию OFF (16)
вунуть из розетки штепсельную вилку и подождать полного размораживания холодильника. (17)

С помощью пылесоса, кисти или щётки неметаллических тщательно прочистить конденсатор рефрижератора и испаритель, предварительно сняв защитные решётки. (73)

ВНИМАНИЕ: Чистка и осмотр рефрижераторного устройства и зоны компрессоров нуждается в квалифицированном авторизированном технике, поэтому не может осуществляться простым персоналом. (30)

Мыть внешние поверхности аппарата, следуя указаниям описанным в параграфе о каждодневном уходе. Холодильники с положительной температурой «НОРМАЛЬНАЯ ТЕМПЕРАТУРА» предусматривают отходное отверстие на внешней стороне отделения.

Проконтролируйте, не загромождено ли это отверстие и прочистите его. (75)

После того, как открыли панель закрытия набора генератора пара, демонтировать трубку пара и удалить известняковые отложения, используя проточную воду. Разобрать бойлер с набором и удалить известняковые отложения, используя проточную воду. Всё собрать. (76а)

На этом генеральные операции по чистке и уходу заканчиваются.

ПЕРЕРЫВ В ИСПОЛЬЗОВАНИИ

В случае, когда холодильник был включен долгое время и для сохранения его в лучшем состоянии действуйте следующим образом:

перевести генеральный выключатель в позицию OFF. (16)

выньте вилку из розетки. (17)

освободите холодильник и вымойте его как описано в параграфе «ЧИСТКА». (76)

удалить воду, находящуюся в бойлере генератора пара после того, как уберётся лента, закрывающая трубу и снять трубу. (76а)

оставить двери холодильника приоткрытыми, для удаления неприятных запахов. (77)

накройте группу компрессоров нейлоновой тканью, для защиты его от пыли. (78)

ИНСТРУКЦИИ ПО ЭКСПЛУАТАЦИИ НЕРЖАВЕЮЩЕЙ СТАЛИ

Холодильные установки изготовлены из нержавеющей стали INOX AISI 304. (79)

Для чистки и ухода за частями, изготовленными из нержавеющей стали придерживайтесь следующих инструкций, помня, что главное и основное правило гарантировать нетоксичность и максимальную гигиеничность продуктов.

Нержавеющая сталь имеет тончайший слой окиси, который предохраняет его от ржавчины.

Существуют средства и частицы, которые могут разрушить его и это приведет к коррозии.

До того как пользоваться тем или иным средством проконсультируйтесь у Вашего поставщика, которому Вы доверяете, пригодно ли это средство для нержавеющей стали. (73)

В случае, когда уже существуют царапины необходимо отполировать их точайшей шерстью для НЕРЖАВЕЮЩЕЙ СТАЛИ или абразивными мочалками из синтетического волокна, начищая в сторону сатинатуры. (80)

ВНИМАНИЕ: Для чистки НЕРЖАВЕЮЩЕЙ СТАЛИ ни когда не пользоваться губками из железа и не оставлять на поверхностях ничего железного, что могло бы оставить следы ржавчины и спровоцировать загрязнение. (81)

ПРОБЛЕМЫ ФУНКЦИОНИРОВАНИЯ

Часто трудности в эксплуатации, которые могут определены это случайные трудности и почти всегда разрешаются без вмешательства специализированного персонала. Поэтому перед вызовом техника проконтролируйте:

ПРОБЛЕМА	ВОЗМОЖНЫЕ ПРИЧИНЫ
Аппаратура не включается	Проконтролируйте, если вилка включена в сеть Проконтролируйте, что ток подходит к розетке
Внутренняя температура очень высокая	Проверить регулирование электронной карты Проверить, что вблизи нет источника тепла Проверить, что дверь плотно закрыта
Аппарат работает очень шумно	Проверить невилирование аппаратуры. Неуравновешанная позиция может быть причиной вибраций Проверьте, что аппаратура не находится в контакте с другой аппаратурой или частями, которые могли бы войти в резонанс
Внутри холодильника неприятные запахи	Имеются продукты с сильным запахом (например сыр и дыня), которые находятся в незакрытых контейнерах Внутренние поверхности должны быть чистыми
На аппарате формируется конденсация	Повышенная влажность помещения Плохо закрыты двери

Прodelайте все эти проверки, если проблема не устраняется, обратитесь в техобслуживание, не забывая сообщить следующее:

- природа дефекта
- модель и номер паспорта аппарата, которые находятся на табличке электрических характеристик, расположенной на щитке аппарата.

ВЫБРОС ОТХОДОВ И ИХ РАЗМЕЩЕНИЕ

СКЛАДИРОВАНИЕ ОТХОДОВ

В конце жизненного цикла продукта не выбрасывать аппаратуру в окружающую среду. Перед выбросом двери аппаратуры должны быть демонтированы.

Допускается временное складирование отдельных отходов под видом выброса посредством обработки окончательного складирования. Руководствуясь действующими законами по охране окружающей среды страны потребителя.

ПРОЦЕДУРА РАЗБОРКИ АППАРАТУРЫ

В каждой стране существуют свои законы по выбросу ненужной аппаратуры, но существуют и общие правила.

Главным образом ненужную аппаратуру сдают в специальные центры по демонтажу.

Разобрать аппаратуру по природе своего химического состава, помня, что в состав компрессора входят смазочные масла и охлаждающая жидкость, которые могут быть использованы заново в выпуске холодильников и, что компоненты холодильника это специальные отходы ассимилируемые службой переработки отходов.

Сдавать на выброс непригодную аппаратуру, разбирая электрические части и любые замки для избежания закрытия кого-либо внутри.

ОПЕРАЦИИ ПО РАЗБОРКЕ ДОЛЖНЫ ПРОВОДИТЬСЯ КВАЛИФИЦИРОВАННЫМ ПЕРСОНАЛОМ.

БЕЗОПАСНОСТЬ ПРИ СБОРЕ ОТХОДОВ ЭЛЕКТРИЧЕСКОГО И ЭЛЕКТРОННОГО ОБОРУДОВАНИЯ (ДИРЕКТИВА 2002/96/ЕС)

Не распространять вредный материал в окружающую среду. Осуществлять переработку в соответствии с действующими законами в этой области.

Согласно директиве 2002/96 (Отходы Электрического и Электронного Оборудования - WEEE), пользователь обязан сдать указанные отходы в специальное место переработки, или вернуть их продавцу, еще установленными при новом приобретении.

Вся аппаратура, которая должна быть переработанная согласно директиве WEEE 2002/96, отмечена одним специальным символом (12)

Незаконная переработка Отходов Электрического и Электронного оборудования наказуема санкциями, отрегулированными действующими законами по территории, на которой установлено нарушение.

ОТХОДЫ ЭЛЕКТРИЧЕСКОГО И ЭЛЕКТРОННОГО ОБОРУДОВАНИЯ МОГУТ СОДЕРЖАТЬ ОПАСНЫЕ ВЕЩЕСТВА С ЭФФЕКТАМИ ПОТЕНЦИАЛЬНО ВРЕДНЫМИ НА ОКРУЖАЮЩУЮ СРЕДУ И НА ЗДОРОВЬЕ ЛЮДЕЙ. СОВЕТУЕТСЯ ОСУЩЕСТВЛЯТЬ ЭТОТ СБОР ПРАВИЛЬНЫМ СПОСОБОМ.

ПЕРЕУСТАНОВКА ДВЕРЕЙ (82)

Холодильные шкафы с одной дверью выпускаются с открытием вправо.

При переустановки их на закрытие влево нужно руководствоваться следующим:

Вращать приборный щиток на боковой части, откручивая винт «остановки» «F».

Открутить два винта крепления зажимной планки «А» и винт «остановки» шарнира «В».

Повернуть дверь и размонтировать шарнир «В» и деталь «Е», перемонтируя их с обратной стороны.

Демонтировать внешнюю зажимную планку «D» переставляя ее на противоположную сторону на подготовленное место.

Установить дверь, располагая отверстие внешней детали «Е» на ось зажимной планки «D»

Зафиксировать зажимную планку «А» с противоположной стороны, закручивая до конца винты крепления.

Перед завинчиванием винтов зажимной планки, проверить часть подвеса должна быть около 12 мм, и перпендикулярность двери по отношению к структуре.

Переместить присутствующий микро на панели управления с противоположной стороны, используя подготовленные отверстия.

Монтировать приборный щиток.

ЗАМЕЧАНИЕ: Операции по демонтажу и монтажу должны происходить при закрытой двери.

ТЕХНИЧЕСКАЯ СХЕМА РЕФРИЖЕРАТОРА

R404a: состав жидкости

трехвалентный фторэтан (HFC 143a) 52%

пятивалентный фторэтан (HFC 125) 44%

четыревалентный фторэтан (HFC 134a) 4%

GWP = 3750

ODP = 0

Распознавание опасностей

Продолжительные ингаляции могут спровоцировать анестетические эффекты. Длительное пребывание вызывает аномалии в сердечном ритме и может спровоцировать внезапную смерть. Продукт сформированный как облако или брызги может спровоцировать язвы на глазах или на коже.

Меры первой помощи

• Ингаляция:

удалить пострадавшего от источника испарения и держать его в тепле и покое. Если необходимо дать ему кислородную подушку. Сделать искусственное дыхание, если оно остановлено. В случае остановки сердца, сделать прямой массаж сердца. Немедленно вызвать скорую помощь.

- Контакт с кожей:
промыть водой замороженные зоны. Снять зараженную одежду.
ВНИМАНИЕ: одежда может пристать к телу в случае отморожения.
Вслучае контакта с телом, немедленно обильно промыть теплой водой. Если появляются симптомы (раздражение или появление волдырей) вызвать медицинскую помощь.
- Контакт с глазами:
немедленно промыть глаза специальной жидкостью для глаз или теплой водой, проподнимая веки, хотя бы на 10 минут. Вызвать медицинскую помощь.
- В случае попадания в желудок:
может спровоцировать рвоту. Если пострадавший в сознании, ополоснуть ему рот водой и дать выпить 200 – 300 мл. воды. Вызвать медицинскую помощь.
- Дополнительное медицинское лечение:
Симптоматический уход и терапия, как было вышеуказанно. Не вводить адреналина и аналогичные медицинские препараты во избежание сердечной аритмии с возможной остановкой сердца.

Экологическая информация

Стойкость и деградация

- HFC 143a:
медленно разлагается в нижней атмосфере (тропосфера). Длительность в атмосфере 55 лет.
- HFC 125:
медленно разлагается в нижней атмосфере (тропосфера). Длительность в атмосфере 40 лет.
- HFC 134a:
очень быстро разлагается в нижней атмосфере (тропосфера). Длительность в атмосфере 15,6 лет.
- HFCs 143a, 125, 134a:
не влияет фотохимический смог (т.е не входит в состав летучих органических компонентов – VOC – по соглашению UNICE (Союз промышленных предприятий европейских сообществ)). Не провоцирует разжижение озона.
Выбросы продукта в атмосферу не провоцируют заражение воды на длительный период.

ЭЛЕКТРИЧЕСКАЯ СХЕМА, РАСПОЛОЖЕНА НА ПОСЛЕДНЕЙ СТРАНИЦЕ КНИЖКИ

Поз.	ОПИСАНИЕ	Поз.	ОПИСАНИЕ
1	ГРУППА КОМПРЕССОРА	44	РЕЛЕ МОЩНОСТИ
2	ВЕНТИЛЯТОР КОНДЕНСАТОРА	44А	РЕЛЕ РТС ИСПАРИТЕЛЯ КОНДЕНСАТА
3	КОНТАКТНЫЙ ВЫВОД ХОЛОДИЛЬНИКА	44В	РЕЛЕ МАГНИТНОГО МИКРОВОКЛЮЧАТЕЛЯ
6	ГЕНЕРАЛЬНЫЙ ВЫКЛЮЧАТЕЛЬ С ИНДИКАТОРОМ	56	ФИЛЬТР ПРОТИВ ПОМЕХ НЕОН. ЛАМПЫ
8	ШТЕПСЕЛЬНАЯ ВИЛКА	69	КЛЕММА ЗАЗЕМЛЕНИЯ
9	ВЕНТИЛЯТОР ИСПАРИТЕЛЯ	70	УСТРОЙСТВО ПОДДЕРЖАНИЯ НАДЕЖН.ВЫСОКОГО ДАВЛЕНИЯ
9А	ВЕНТИЛЯТОР ИСПАРИТЕЛЯ	75	ЭЛЕКТРОВЕНТИЛЬ
9В	ВЕНТИЛЯТОР ИСПАРИТЕЛЯ	76	МАГНИТНЫЙ МИКРОВОКЛЮЧАТЕЛЬ
10	ЛАМПОЧКА ВНУТРЕННЯЯ ПРОЁМ	85	РАСПРЕДЕЛИТЕЛЬНАЯ КОРОБКА
10А	ЛАМПОЧКА ВНУТРЕННЯЯ ПРОЁМ	86	ЗОНД КОНДЕНСАТОРА
12	ЭЛЕКТРОКЛАПАН РАЗМОЖИВАНИЯ	90	ЦИФРОВОЙ ТЕРМОРЕГУЛЯТОР
14	РАСПРЕДЕЛИТЕЛЬ ВЛАЖНОСТИ	91	РЕЗИСТОР РТС
15	МИКРО ВЫКЛЮЧАТЕЛЬ КРЫЛЬЧАТКИ	96	ЭЛЕКТРОННОЙ КАРТЫ
15А	МИКРО ВЫКЛЮЧАТЕЛЬ КРЫЛЬЧАТКИ	101	СОПРОТИВЛЕНИЕ ТАМПОНА
18	ИНДИКАТОР БЕЗОПАСНОСТИ	102	ТЕРМОСТАТ БЕЗОПАСНОСТИ ДВУМЕТТАЛИЧЕСКИЙ
19	ТЕРМОСТАТ БЕЗОПАСНОСТИ	103	ЗОНД ВЛАЖНОСТИ
20	СОПРОТИВЛЕНИЕ АНТИКОНДЕНСАЦИИ ДВЕРЕЙ	104	РЕГУЛЯТОР УРОВНЯ
20А	СОПРОТИВЛЕНИЕ АНТИКОНДЕНСАЦИИ ДВЕРЕЙ	105	ЗОНД УРОВНЯ
21	СОПРОТИВЛЕНИЕ РАЗМОЖИВАНИЯ	106	ТЕРМОСТАТ БЕЗОПАСНОСТИ ГЕНЕРАТОРА ПАРА
22	СОПРОТИВЛЕНИЕ ДНА БАЧКА	107	ЭЛЕКТРИЧЕСКОЕ СОПРОТИВЛЕНИЕ ЯЧЕЙКИ
25	ТРАНСФОРМАТОР НАПРЯЖЕНИЯ	108	СОПРОТИВЛЕНИЕ ГЕНЕРАТОРА ПАРА
28	ВЫКЛЮЧАТЕЛЬ НЕОНОВОЙ ЛАМПЫ	109	КАРТОЧКА ЩИТА ОСТАНОВКИ БРОЖЕНИЯ
29	РЕАКТОР НЕОНОВОЙ ЛАМПЫ	110	КАРТОЧКА КОМАНД ОСТАНОВКИ БРОЖЕНИЯ
30	СТАРТЁР НЕОНОВОЙ ЛАМПЫ	111	КАРТОЧКА РАЗШИРЕНИЯ РЕЛЕ ОСТАНОВКИ БРОЖЕНИЯ
31	НЕОНОВАЯ ЛАМПА	112	ЭЛЕКТРО КЛАПАН ВОДЫ УВЛАЖНЕНИЯ

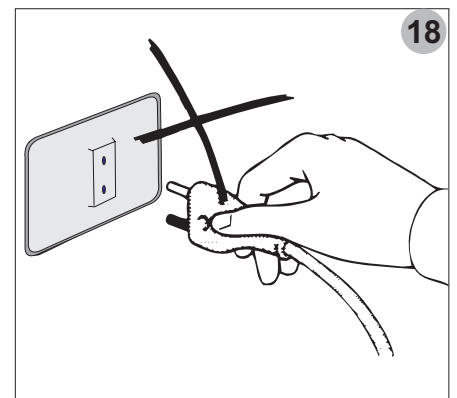
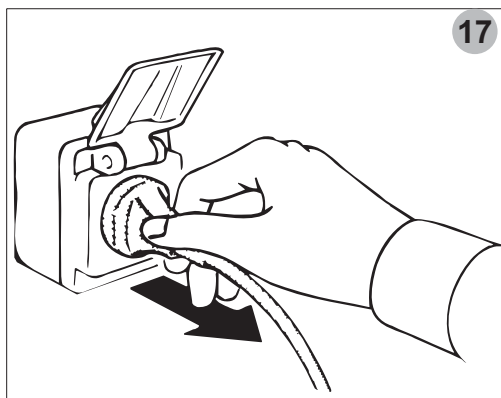
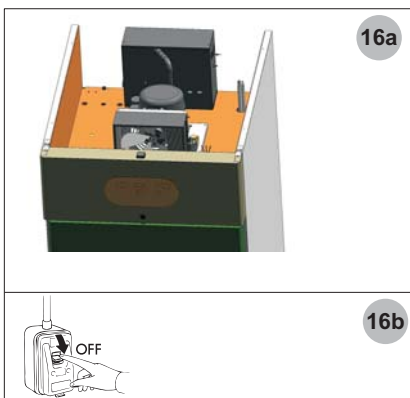
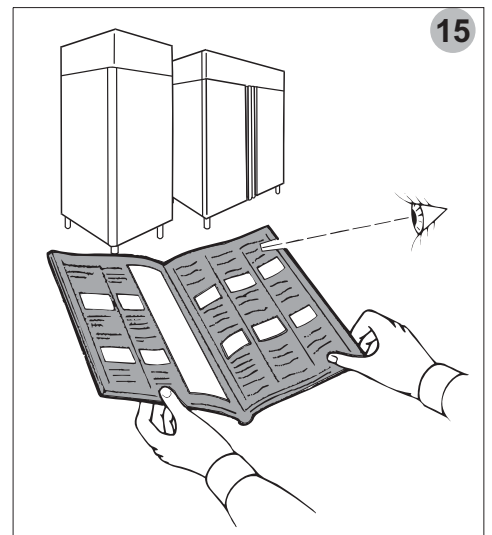
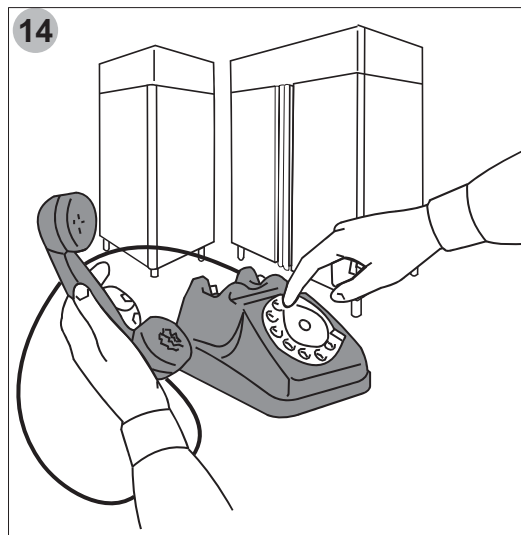
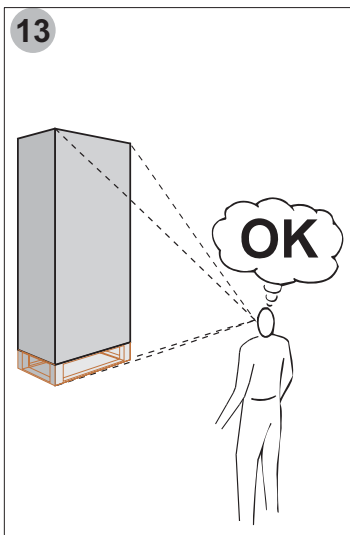
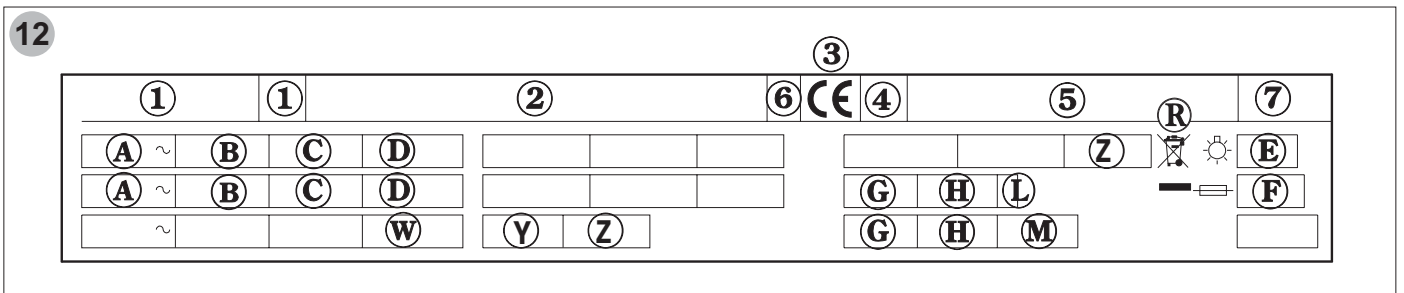
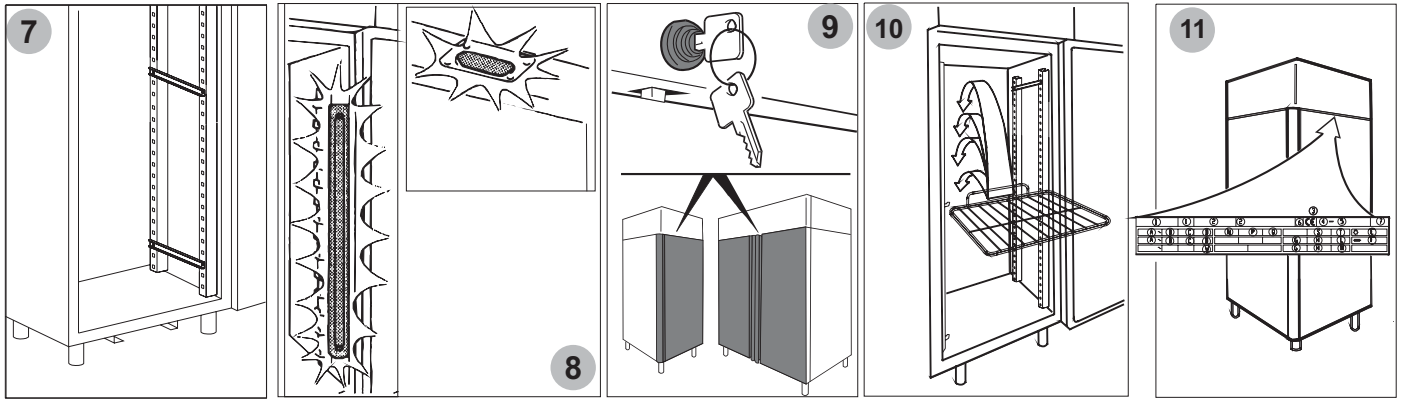
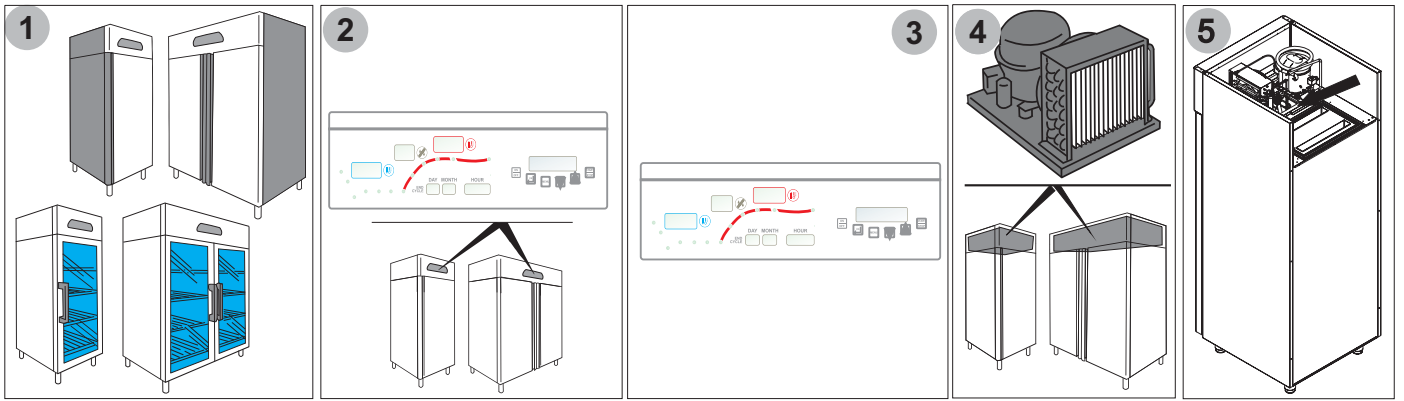

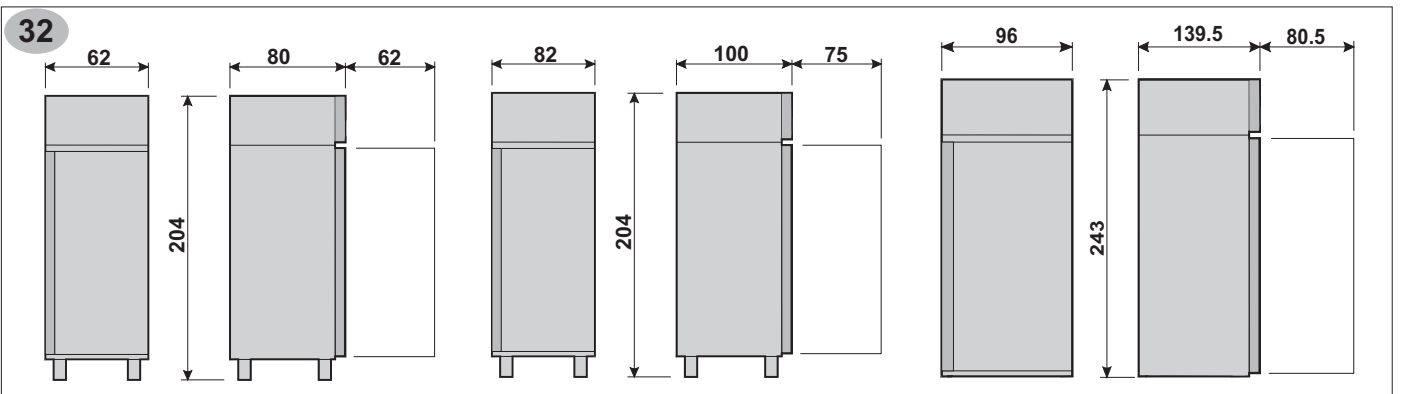
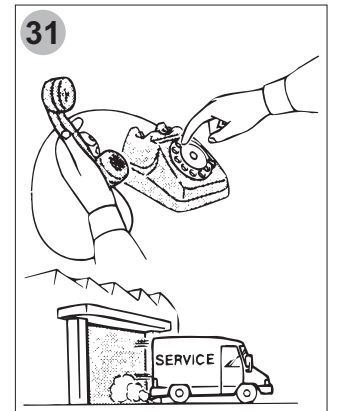
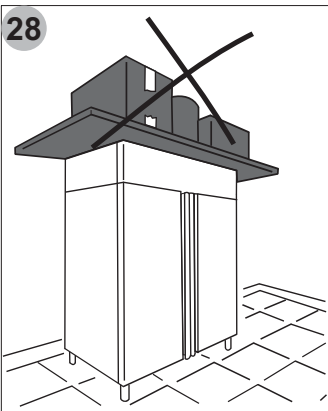
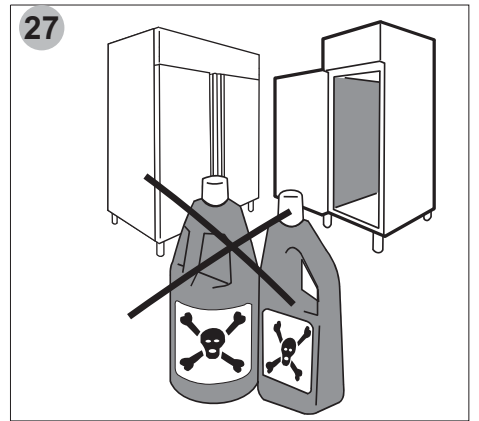
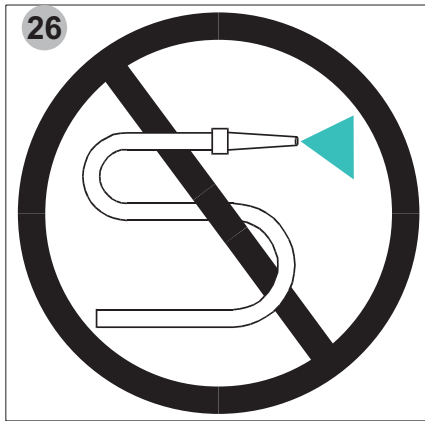
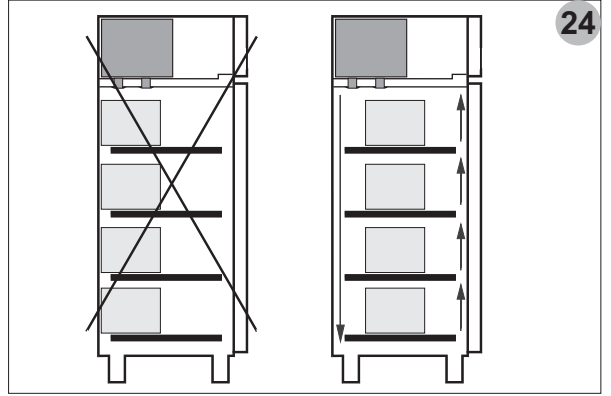
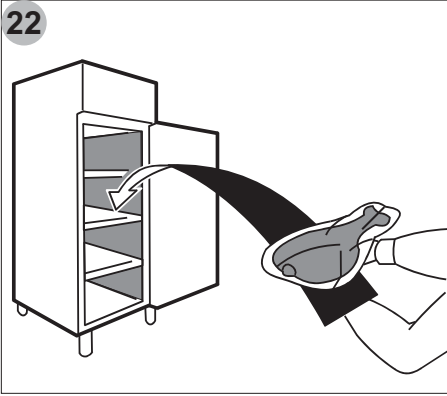
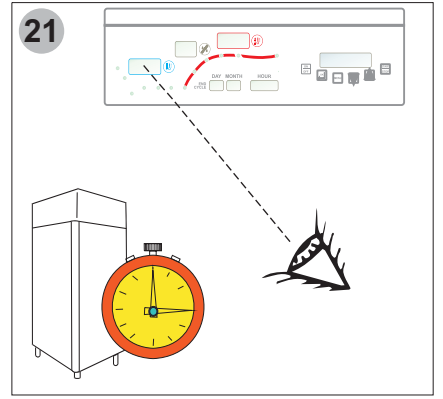
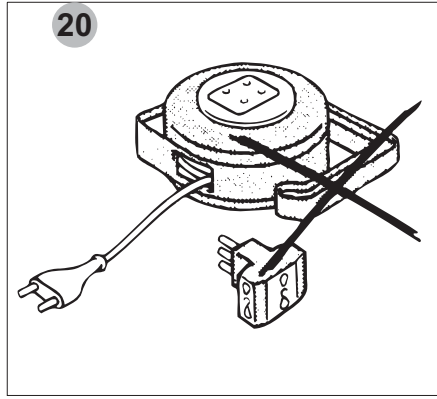
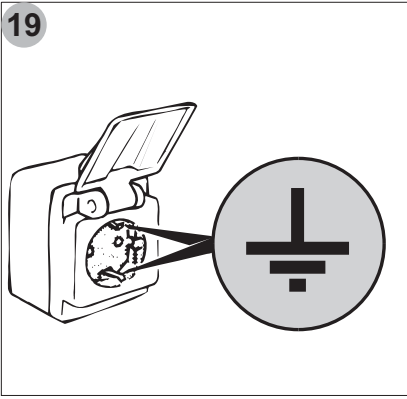

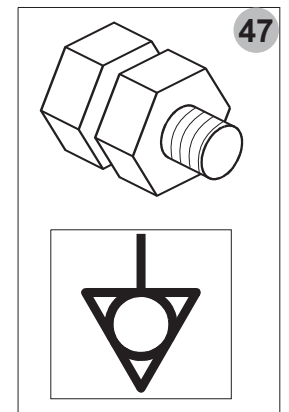
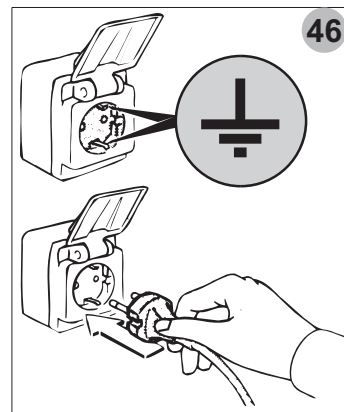
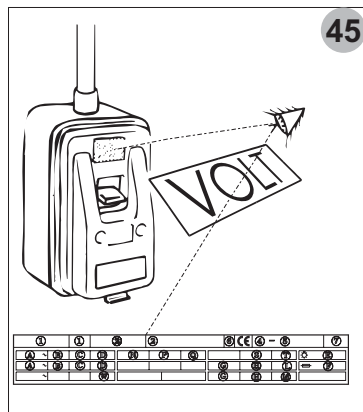
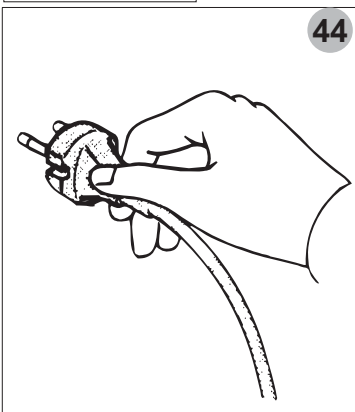
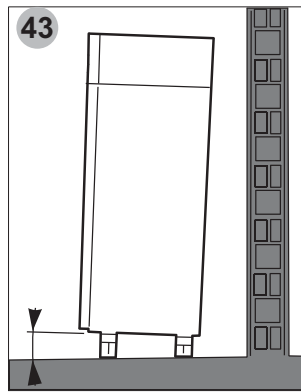
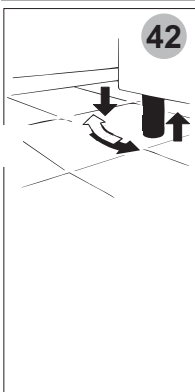
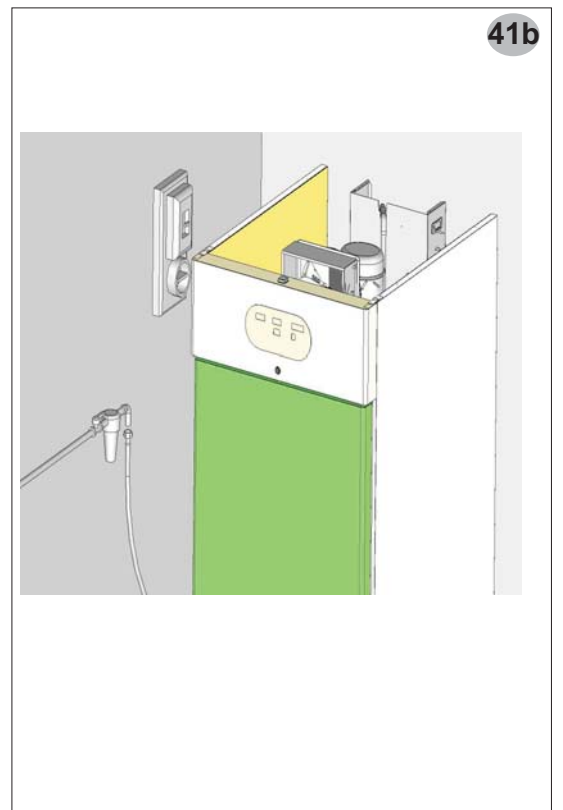
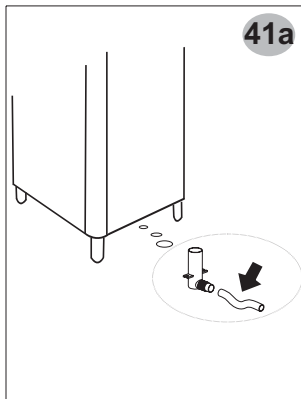
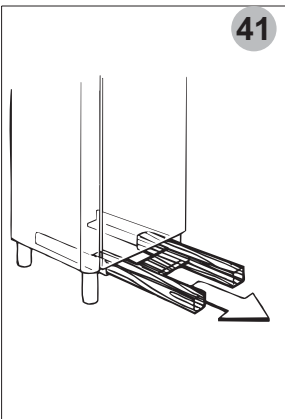
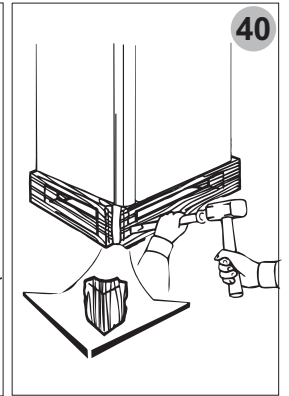
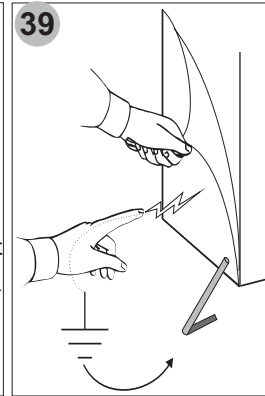
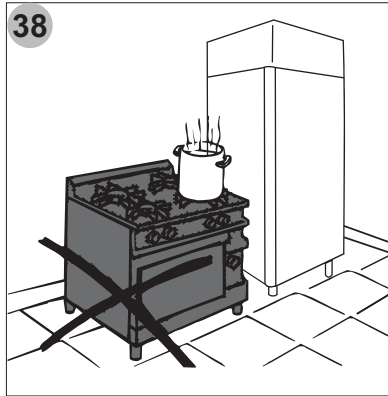
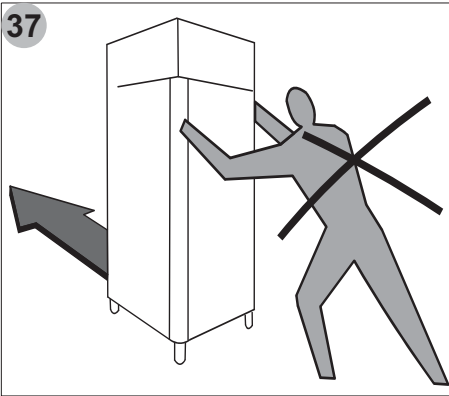
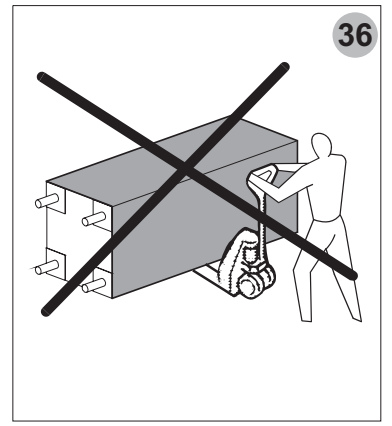
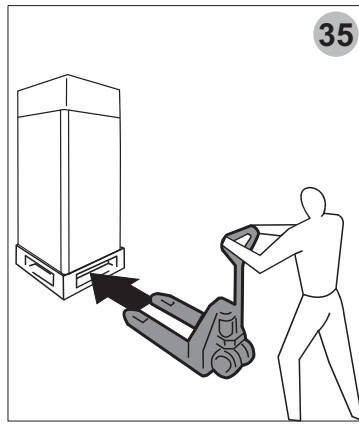
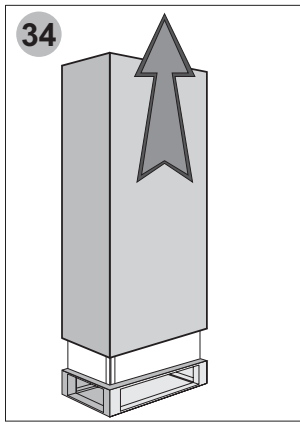
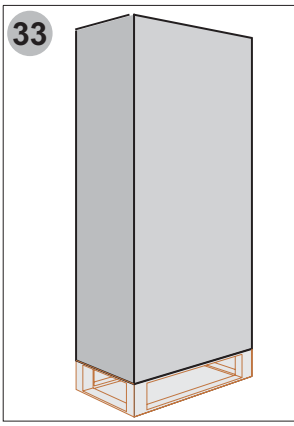

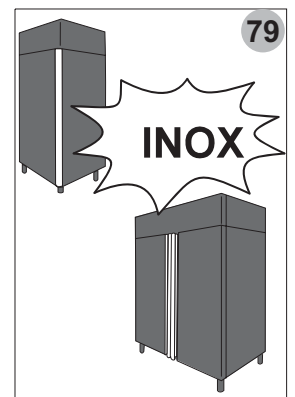
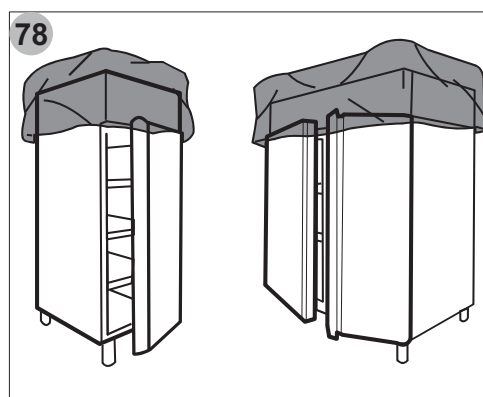
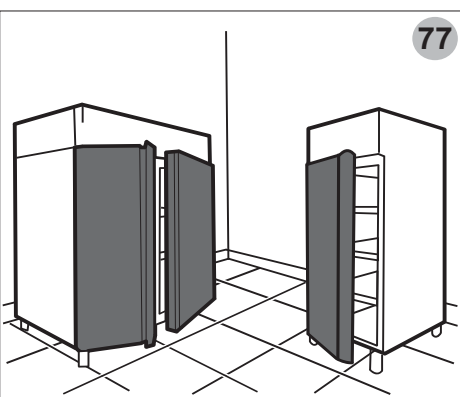
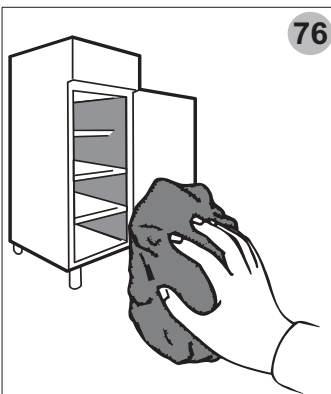
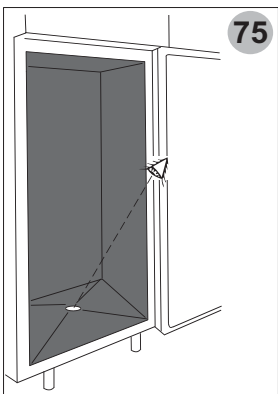
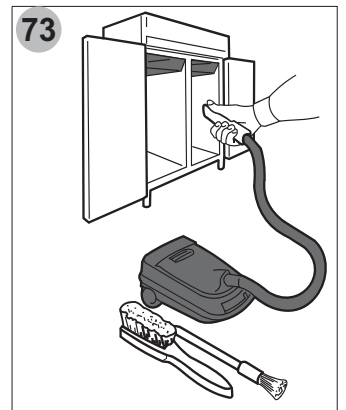
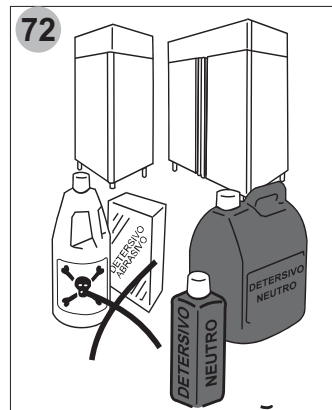
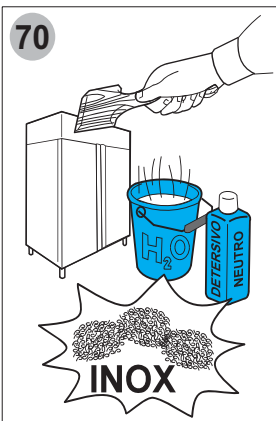
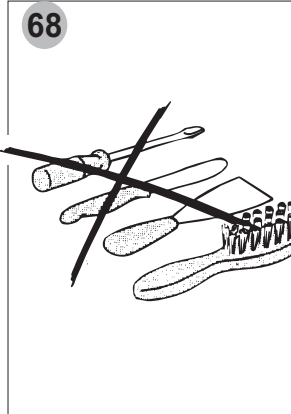
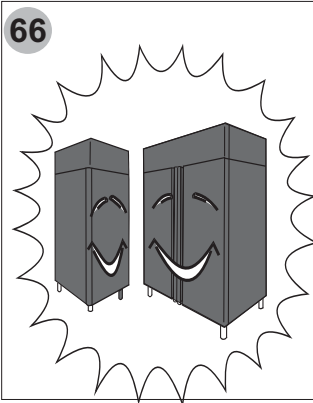
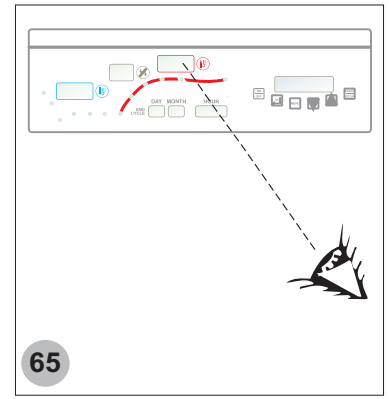
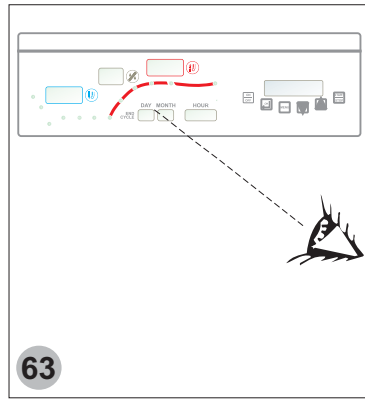
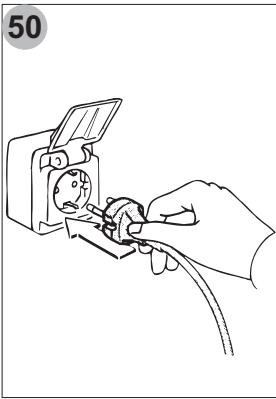

80

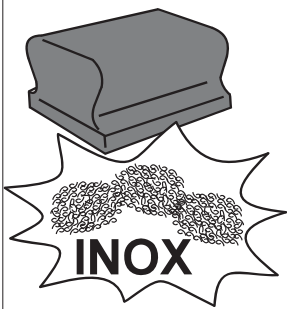

81

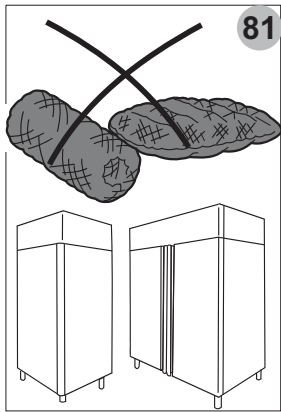

82

