

TOSHIBA

FILE NO. A08-004

SERVICE MANUAL

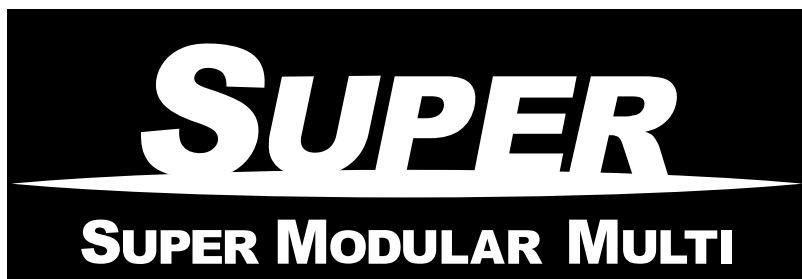

<4-Way Air Discharge Cassette Type>

***MMU-AP0092H, MMU-AP0122H,
MMU-AP0152H, MMU-AP0182H,
MMU-AP0242H, MMU-AP0272H,
MMU-AP0302H, MMU-AP0362H,
MMU-AP0482H, MMU-AP0562H***









- This Service Manual describes contents of the 4-Way Air Discharge Cassette indoor unit. For the outdoor unit, refer to the Manual with **FILE No. A03-009, A05-004, A05-015.**

CONTENTS







SAFETY CAUTION	3
1. SPECIFICATIONS	8
2. CONSTRUCTION VIEWS (EXTERNAL VIEWS)	12
3. WIRING DIAGRAM	16
4. PARTS RATING	17
5. REFRIGERATING CYCLE DIAGRAM	51
6. CONTROL OUTLINE	52
7. CONFIGURATION OF CONTROL CIRCUIT	62
8. APPLIED CONTROL	70
9. TROUBLESHOOTING	84
10. DETACHMENTS	107
11. P.C. BOARD EXCHANGE PROCEDURES	118
12. EXPLODED VIEWS AND PARTS LIST	123

SAFETY CAUTION



The important contents concerned to the safety are described on the product itself and on this Service Manual. Please read this Service Manual after understanding the described items thoroughly in the following contents, and keep them.

 WARNING	
 Check earth wires.	Before troubleshooting or repair work, check the earth wire is connected to the earth terminals of the main unit, otherwise an electric shock is caused when a leak occurs. If the earth wire is not correctly connected, contact an electric engineer for rework.
 Prohibition of modification.	Do not modify the products. Do not also disassemble or modify the parts. It may cause a fire, electric shock or injury.
 Use specified parts.	For spare parts, use those specified (*). If unspecified parts are used, a fire or electric shock may be caused. *: For details, refer to the parts list.
 Do not bring a child close to the equipment.	Before troubleshooting or repair work, do not bring a third party (a child, etc.) except the repair engineers close to the equipment. It causes an injury with tools or disassembled parts. Please inform the users so that the third party (a child, etc.) does not approach the equipment.
 Insulating measures	Connect the cut-off lead cables with crimp contact, etc, put the closed end side upward and then apply a water-cut method, otherwise a leak or production of fire is caused at the users' side.
 No fire	When repairing the refrigerating cycle, take the following measures. 1) Be attentive to fire around the cycle. When using a gas stove, etc, be sure to put out fire before work; otherwise the oil mixed with refrigerant gas may catch fire. 2) Do not use a welder in the closed room. When using it without ventilation, carbon monoxide poisoning may be caused. 3) Do not bring inflammables close to the refrigerant cycle, otherwise fire of the welder may catch the inflammables.
 Refrigerant	Check the used refrigerant name and use tools and materials of the parts which match with it. For the products which use R410A refrigerant, the refrigerant name is indicated at a position on the outdoor unit where is easy to see. To prevent miss-charging, the route of the service port is changed from one of the former R22. For an air conditioner which uses R410A, never use other refrigerant than R410A. For an air conditioner which uses other refrigerant (R22, etc.), never use R410A. If different types of refrigerant are mixed, abnormal high pressure generates in the refrigerating cycle and an injury due to breakage may be caused. Do not charge refrigerant additionally. If charging refrigerant additionally when refrigerant gas leaks, the refrigerant composition in the refrigerating cycle changes resulted in change of air conditioner characteristics or refrigerant over the specified standard amount is charged and an abnormal high pressure is applied to the inside of the refrigerating cycle resulted in cause of breakage or injury. Therefore if the refrigerant gas leaks, recover the refrigerant in the air conditioner, execute vacuuming, and then newly recharge the specified amount of liquid refrigerant. In this time, never charge the refrigerant over the specified amount. When recharging the refrigerant in the refrigerating cycle, do not mix the refrigerant or air other than R410A into the specified refrigerant. If air or others is mixed with the refrigerant, abnormal high pressure generates in the refrigerating cycle resulted in cause of injury due to breakage. After installation work, check the refrigerant gas does not leak. If the refrigerant gas leaks in the room, poisonous gas generates when gas touches to fire such as fan heater, stove or cooking stove though the refrigerant gas itself is innocuous. Never recover the refrigerant into the outdoor unit. When the equipment is moved or repaired, be sure to recover the refrigerant with recovering device. The refrigerant cannot be recovered in the outdoor unit; otherwise a serious accident such as breakage or injury is caused.

⚠ WARNING

 Assembly/Cabling	<p>After repair work, surely assemble the disassembled parts, and connect and lead the removed cables as before. Perform the work so that the cabinet or panel does not catch the inner cables.</p> <p>If incorrect assembly or incorrect cable connection was done, a disaster such as a leak or fire is caused at user's side.</p>
 Insulator check	<p>After the work has finished, be sure to use an insulation tester set (500V mugger) to check the resistance is 2MW or more between the charge section and the non-charge metal section (Earth position).</p> <p>If the resistance value is low, a disaster such as a leak or electric shock is caused at user's side.</p>
 Ventilation	<p>When the refrigerant gas leaks during work, execute ventilation.</p> <p>If the refrigerant gas touches to a fire, poisonous gas generates. A case of leakage of the refrigerant and the closed room full with gas is dangerous because a shortage of oxygen occurs. Be sure to execute ventilation.</p>
 Be attentive to electric shock	<p>When checking the circuit inevitably under condition of the power-ON, use rubber gloves and others not to touch to the charging section.</p> <p>If touching to the charging section, an electric shock may be caused.</p>
 Compulsion	<p>When the refrigerant gas leaks, find up the leaked position and repair it surely.</p> <p>If the leaked position cannot be found up and the repair work is interrupted, pump-down and tighten the service valve, otherwise the refrigerant gas may leak into the room.</p> <p>The poisonous gas generates when gas touches to fire such as fan heater, stove or cooking stove though the refrigerant gas itself is innocuous.</p> <p>When installing equipment which includes a large amount of charged refrigerant such as a multi air conditioner in a sub-room, it is necessary that the density does not the limit even if the refrigerant leaks.</p> <p>If the refrigerant leaks and exceeds the limit density, an accident of shortage of oxygen is caused.</p> <p>For the installation/moving/reinstallation work, follow to the Installation Manual.</p> <p>If an incorrect installation is done, a trouble of the refrigerating cycle, water leak, electric shock or fire is caused.</p>
 Check after reair	<p>After repair work has finished, check there is no trouble.</p> <p>If check is not executed, a fire, electric shock or injury may be caused. For a check, turn off the power breaker.</p> <p>After repair work (installation of front panel and cabinet) has finished, execute a test run to check there is no generation of smoke or abnormal sound.</p> <p>If check is not executed, a fire or an electric shock is caused. Before test run, install the front panel and cabinet.</p>
 Check after reinstallation	<p>Check the following items after reinstallation.</p> <ol style="list-style-type: none"> 1) The earth wire is correctly connected. 2) The power cord is not caught in the product. 3) There is no inclination or unsteadiness and the installation is stable. <p>If check is not executed, a fire, an electric shock or an injury is caused.</p>

⚠ CAUTION

 Put on gloves	<p>Be sure to put on gloves (*) and long-sleeved shirt during repair work.</p> <p>If not putting on gloves, an injury may be caused with the parts, etc.</p> <p>(*) Heavy gloves such as work gloves</p>
 Cooling check	<p>When the power was turned on, start to work after the equipment has been sufficiently cooled.</p> <p>As temperature of the compressor pipes and others became high due to cooling/heating operation, a burn may be caused.</p>

• New Refrigerant (R410A)

This air conditioner adopts a new HFC type refrigerant (R410A) which does not deplete the ozone layer.

1. Safety Caution Concerned to New Refrigerant

The pressure of R410A is high 1.6 times of that of the former refrigerant (R22).

Accompanied with change of refrigerant, the refrigerating oil has been also changed.

Therefore, be sure that water, dust, the former refrigerant or the former refrigerating oil is not mixed into the refrigerating cycle of the air conditioner with new refrigerant during installation work or service work.

If an incorrect work or incorrect service is performed, there is a possibility to cause a serious accident.

Use the tools and materials exclusive to R410A to purpose a safe work.

2. Cautions on Installation/Service

(1) Do not mix the other refrigerant or refrigerating oil.

For the tools exclusive to R410A, shapes of all the joints including the service port differ from those of the former refrigerant in order to prevent mixture of them.

(2) As the use pressure of the new refrigerant is high, use material thickness of the pipe and tools which are specified for R410A.

(3) In the installation time, use clean pipe materials and work with great attention so that water and others do not mix in because pipes are affected by impurities such as water, oxide scales, oil, etc.

Use the clean pipes.

Be sure to brazing with flowing nitrogen gas. (Never use gas other than nitrogen gas.)

(4) For the earth protection, use a vacuum pump for air purge.

(5) R410A refrigerant is azeotropic mixture type refrigerant.

Therefore use liquid type to charge the refrigerant. (If using gas for charging, composition of the refrigerant changes and then characteristics of the air conditioner change.)

3. Pipe Materials

For the refrigerant pipes, copper pipe and joints are mainly used.

It is necessary to select the most appropriate pipes to conform to the standard.

Use clean material in which impurities adhere inside of pipe or joint to a minimum.

(1) Copper pipe

<Piping>

The pipe thickness, flare finishing size, flare nut and others differ according to a refrigerant type.

When using a long copper pipe for R410A, it is recommended to select "Copper or copper-base pipe without seam" and one with bonded oil amount 40mg/10m or less.

Also do not use crushed, deformed, discolored (especially inside) pipes. (Impurities cause clogging of expansion valves and capillary tubes.)

<Flare nut>

Use the flare nuts which are attached to the air conditioner unit.

(2) Joint

The flare joint and socket joint are used for joints of the copper pipe.

The joints are rarely used for installation of the air conditioner.

However clear impurities when using them.

4. Tools

(1) Required Tools for R410A

Mixing of different types of oil may cause a trouble such as generation of sludge, clogging of capillary, etc. Accordingly, the tools to be used are classified into the following three types.

- 1) Tools exclusive for R410A (Those which cannot be used for conventional refrigerant (R22))
- 2) Tools exclusive for R410A, but can be also used for conventional refrigerant (R22)
- 3) Tools commonly used for R410A and for conventional refrigerant (R22)

The table below shows the tools exclusive for R410A and their interchangeability.

Tools exclusive for R410A (The following tools for R410A are required.)

Tools whose specifications are changed for R410A and their interchangeability

No.	Used tool	Usage	R410A air conditioner installation		Conventional air conditioner installation
			Existence of new equipment for R410A	Whether conventional equipment can be used	Whether new equipment can be used with conventional refrigerant
①	Flare tool	Pipe flaring	Yes	*(Note 1)	Yes
②	Copper pipe gauge for adjusting projection margin	Flaring by conventional flare tool	Yes	*(Note 1)	*(Note 1)
③	Torque wrench	Connection of flare nut	Yes	No	No
④	Gauge manifold	Evacuating, refrigerant charge, run check, etc.	Yes	No	No
⑤	Charge hose				
⑥	Vacuum pump adapter	Vacuum evacuating	Yes	No	Yes
⑦	Electronic balance for refrigerant charging	Refrigerant charge	Yes	Yes	Yes
⑧	Refrigerant cylinder	Refrigerant charge	Yes	No	No
⑨	Leakage detector	Gas leakage check	Yes	No	Yes
⑨	Charging cylinder	Refrigerant charge	(Note 2)	No	No

(Note 1) When flaring is carried out for R410A using the conventional flare tools, adjustment of projection margin is necessary. For this adjustment, a copper pipe gauge, etc. are necessary.

(Note 2) Charging cylinder for R410A is being currently developed.

General tools (Conventional tools can be used.)

In addition to the above exclusive tools, the following equipments which serve also for R22 are necessary as the general tools.

- 1) Vacuum pump
Use vacuum pump by attaching vacuum pump adapter.
- 2) Torque wrench
- 3) Pipe cutter
- 4) Reamer
- 5) Pipe bender
- 6) Level vial
- 7) Screwdriver (+, -)
- 8) Spanner or Monkey wrench
- 9) Hole core drill
- 10) Hexagon wrench (Opposite side 4mm)
- 11) Tape measure
- 12) Metal saw

Also prepare the following equipments for other installation method and run check.

- 1) Clamp meter
- 2) Thermometer
- 3) Insulation resistance tester
- 4) Electro-scope

5. Recharge of Refrigerant

When recharge of the refrigerant is required, charge the new refrigerant with the specified amount in the procedure as described below.

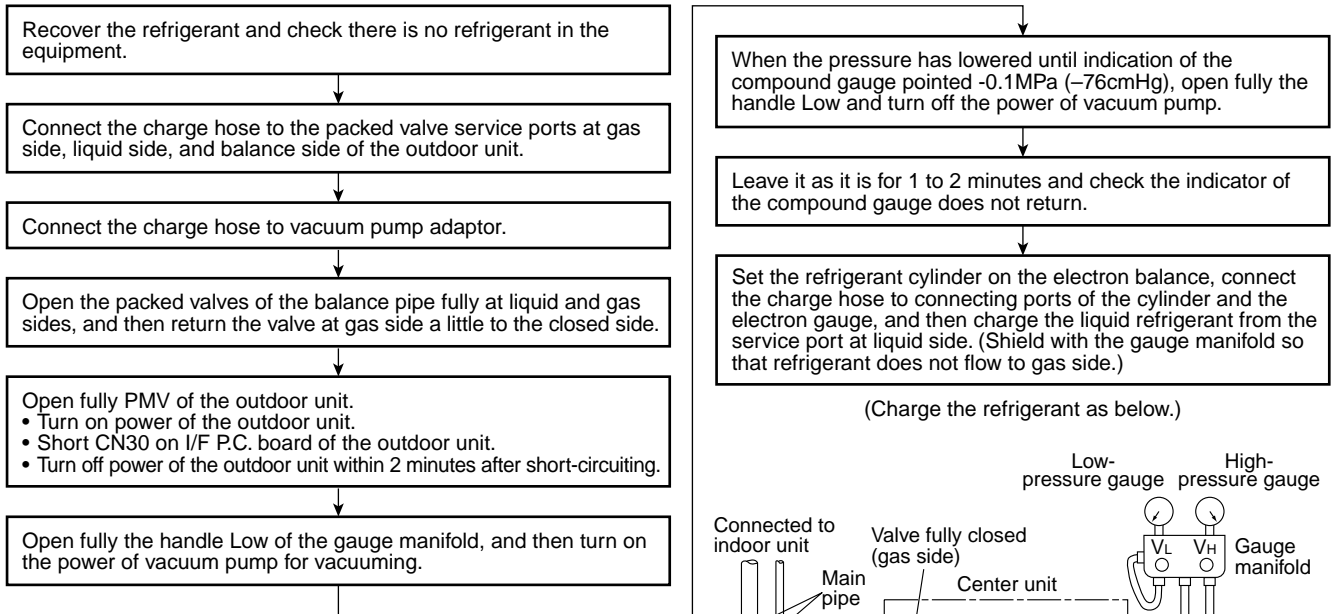

- 1) Never charge the refrigerant over the specified amount.
- 2) Do not charge the additional refrigerant. If charging refrigerant additionally when refrigerant gas leaks, the refrigerant composition in the refrigerating cycle changes resulted in change of air conditioner characteristics or refrigerant over the specified standard amount is charged and an abnormal high pressure is applied to the inside of the refrigerating cycle resulted in cause of breakage or injury.

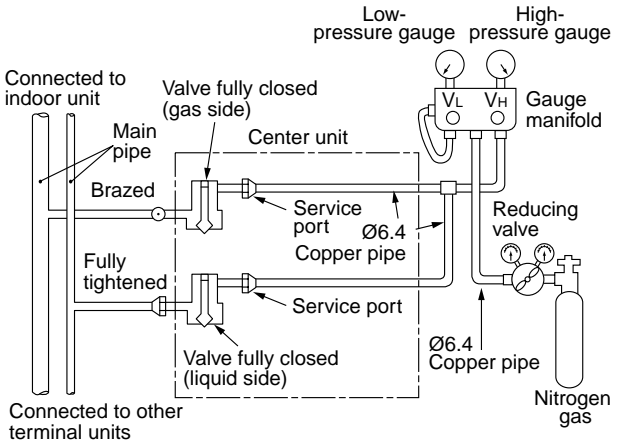

4mm-hexagonal wrench is required.

- 1) Set the equipment so that liquid refrigerant can be charged.
- 2) When using a cylinder with siphon pipe, liquid can be charged without inverting the cylinder.

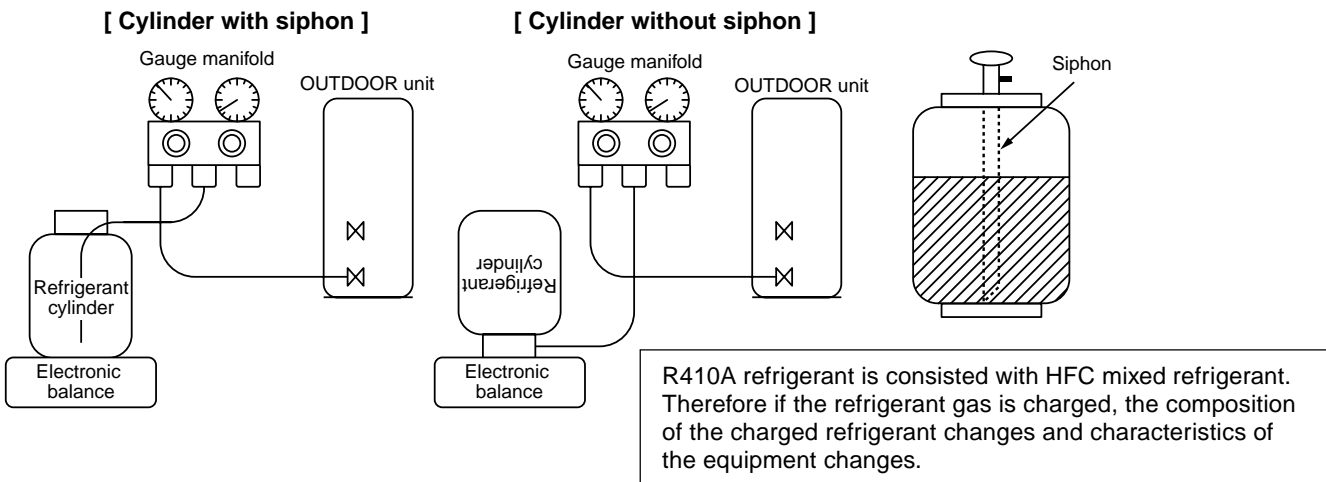

R410A refrigerant is consisted with HFC mixed refrigerant. Therefore if the refrigerant gas is charged, the composition of the charged refrigerant changes and characteristics of the equipment changes.

6. Environment

Use "Vacuum pump method" for an air purge (Discharge of air in the connecting pipe) in installation time.

- Do not discharge flon gas into the air to protect the earth environment.
- Using the vacuum pump method, clear the remained air (Nitrogen, etc.) in the unit. If the air remains, the pressure in the refrigerating cycle becomes abnormally high and an injury and others are caused due to burst.

1. SPECIFICATIONS

1-1. Indoor Unit

Model name		MMU-AP0092H	MMU-AP0122H
Cooling capacity (*1) kW		2.8	3.6
Heating capacity (*1) kW		3.2	4.0
Electrical characteristics	Power supply	1phase 50Hz 230V(220V-240V) /1phase 60Hz 220V (Separate power supply for indoor units is required.)	
	Running current A	0.23 / 0.24	0.23 / 0.24
	Power consumption kW	0.021 / 0.021	0.021 / 0.021
	Starting current A	0.30 / 0.30	0.30 / 0.30
Appearance		Heat-insulating material attached Zinc hot dipping steel plate	
Outer dimension	Height mm	256	256
	Width mm	840	840
	Depth mm	840	840
Total weight kg		18	18
Heat exchanger		Finned tube	
Soundproof/Heat-insulating material		Non-flammable insulation	
Fan unit	Fan	Turbo fan	
	Standard air flow (-M -L) m ³ /h	800 (-730 -680)	800 (-730 -680)
	Motor W	14	14
Air filter		Standard filter (Long life filter)	
Controller (*2)		Remote controller	
Connecting pipe	Gas side mm	Ø9.5	Ø9.5
	Liquid side mm	Ø6.4	Ø6.4
Drain port (Nominal dia. mm)		25 (Polyvinyl chloride tube)	
Sound pressure level High(-Mid.-Low) dB		30-29-27	30-29-27
Ceiling panel (*2)	Model name	RBC-U31PG(W)-E	
	Appearance (Color)	White (2.5GY9.0/0.5)	
	Outer dimension mm	Height 30 × Width 950 × Depth 950	
	Total weight kg	4.0	
Remote controller wiring (200m or less) (200m - 500m)		VCTF 0.3mm ² (2cores) VCTF 0.5 to 2.0mm ² (2cores)	
Crossover wiring (Up to 1000m) (Up to 2000m)		MVVS (Shield wire) 1.25mm ² × 2cores MVVS (Shield wire) 2.00mm ² × 2cores	
Option parts	Spacer for height adjustment	TCB-SP1602UE	TCB-SP1602UE
	Fresh-air chamber	TCB-GFC1602UE	TCB-GFC1602UE
	Fresh-air inlet box	TCB-GB1602UE	TCB-GB1602UE
	Air-discharge direction kit	TCB-BC1602UE	TCB-BC1602UE
	Auxiliary fresh air flange	TCB-FF101URE2	TCB-FF101URE2

(*1) Cooling / heating capacity is based on single connection operation with standard piping length under Japanese Industrial Standard B 8615 Condition 1.

(*2) Remote controller and ceiling panel are sold separately.

Model name		MMU-AP0152H	MMU-AP0182H
Cooling capacity (*1) kW		4.5	5.6
Heating capacity (*1) kW		5.0	6.3
Electrical characteristics	Power supply	1phase 50Hz 230V (220V-240V) / 1phase 60Hz 220V (Separate power supply for indoor units is required.)	
	Running current A	0.27 / 0.28	0.29 / 0.30
	Power consumption kW	0.023 / 0.023	0.026 / 0.026
	Starting current A	0.33 / 0.33	0.36 / 0.36
Appearance		Heat-insulating material attached Zinc hot dipping steel plate	
Outer dimension	Height mm	256	256
	Width mm	840	840
	Depth mm	840	840
Total weight kg		20	20
Heat exchanger		Finned tube	
Soundproof/Heat-insulating material		Non-flammable insulation	
Fan unit	Fan	Turbo fan	
	Standard air flow (-M -L) m ³ /h	930 (-830 -790)	1050 (-920 -800)
	Motor W	14	14
Air filter		Standard filter (Long life filter)	
Controller (*2)		Remote controller	
Connecting pipe	Gas side mm	Ø12.7	Ø12.7
	Liquid side mm	Ø6.4	Ø6.4
Drain port (Nominal dia. mm)		25 (Polyvinyl chloride tube)	
Sound pressure level High(-Mid.-Low) dB		31-29-27	32-29-27
Ceiling panel (*2)	Model name	RBC-U31PG(W)-E	
	Appearance (Color)	White (2.5GY9.0/0.5)	
	Outer dimension mm	Height 30 x Width 950 x Depth 950	
	Total weight kg	4.0	
Remote controller wiring (200m or less) (200m - 500m)		VCTF 0.3mm ² (2cores) VCTF 0.5 to 2.0mm ² (2cores)	
Crossover wiring (Up to 1000m) (Up to 2000m)		MVVS (Shield wire) 1.25mm ² x 2cores MVVS (Shield wire) 2.00mm ² x 2cores	
Option parts	Spacer for height adjustment	TCB-SP1602UE	TCB-SP1602UE
	Fresh-air chamber	TCB-GFC1602UE	TCB-GFC1602UE
	Fresh-air inlet box	TCB-GB1602UE	TCB-GB1602UE
	Air-discharge direction kit	TCB-BC1602UE	TCB-BC1602UE
	Auxiliary fresh air flange	TCB-FF101URE2	TCB-FF101URE2

(*1) Cooling / heating capacity is based on single connection operation with standard piping length under Japanese Industrial Standard B 8615 Condition 1.

(*2) Remote controller and ceiling panel are sold separately.

Model name		MMU-AP0242H	MMU-AP0272H	MMU-AP0302H	
Cooling capacity	(*1) kW	7.1	8.0	9.0	
Heating capacity	(*1) kW	8.0	9.0	10.0	
Electrical characteristics	Power supply	1 phase 50Hz 230V (220V-240V) / 1 phase 60Hz 220V (Separate power supply for indoor units is required.)			
	Running current	A	0.38 / 0.39	0.38 / 0.39	0.43 / 0.45
	Power consumption	kW	0.036 / 0.036	0.036 / 0.036	0.043 / 0.043
	Starting current	A	0.42 / 0.42	0.42 / 0.42	0.59 / 0.59
Appearance		Heat-insulating material attached Zinc hot dipping steel plate			
Outer dimension	Height	mm	256	256	256
	Width	mm	840	840	840
	Depth	mm	840	840	840
Total weight	kg	20	20	20	
Heat exchanger		Finned tube			
Soundproof/Heat-insulating material		Non-flammable insulation			
Fan unit	Fan	Turbo fan			
	Standard air flow (-M -L)	m ³ /h	1290 (-920 -800)	1290 (-920 -800)	1320 (-1110 -850)
	Motor	W	20	20	20
Air filter		Standard filter (Long life filter)			
Controller		(*2)	Remote controller		
Connecting pipe	Gas side	mm	Ø15.9	Ø15.9	Ø15.9
	Liquid side	mm	Ø9.5	Ø9.5	Ø9.5
Drain port (Nominal dia. mm)		25 (Polyvinyl chloride tube)			
Sound pressure level	High(-Mid.-Low)	dB	35-31-28	35-31-28	38-33-30
Ceiling panel (*2)	Model name	RBC-U31PG(W)-E			
	Appearance (Color)	White (2.5GY9.0/0.5)			
	Outer dimension	mm	Height 30 × Width 950 Ø Depth 950		
	Total weight	kg	4.0		
Remote controller wiring		(200m or less) (200m - 500m)	VCTF 0.3mm ² (2cores) VCTF 0.5 to 2.0mm ² (2cores)		
Crossover wiring		(Up to 1000m) (Up to 2000m)	MVVS (Shield wire) 1.25mm ² × 2cores MVVS (Shield wire) 2.00mm ² × 2cores		
Option parts	Spacer for height adjustment	TCB-SP1602UE	TCB-SP1602UE	TCB-SP1602UE	
	Fresh-air chamber	TCB-GFC1602UE	TCB-GFC1602UE	TCB-GFC1602UE	
	Fresh-air inlet box	TCB-GB1602UE	TCB-GB1602UE	TCB-GB1602UE	
	Air-discharge direction kit	TCB-BC1602UE	TCB-BC1602UE	TCB-BC1602UE	
	Auxiliary fresh air flange	TCB-FF101URE2	TCB-FF101URE2	TCB-FF101URE2	

(*1) Cooling / heating capacity is based on single connection operation with standard piping length under Japanese Industrial Standard B 8615 Condition 1.

(*2) Remote controller and ceiling panel are sold separately.

Model name		MMU-AP0362H	MMU-AP0482H	MMU-AP0562H	
Cooling capacity	(*1) kW	11.2	14.0	16.0	
Heating capacity	(*1) kW	12.5	16.0	18.0	
Electrical characteristics	Power supply	1 phase 50Hz 230V (220V-240V) / 1 phase 60Hz 220V (Separate power supply for indoor units is required.)			
	Running current	A	0.73 / 0.76	0.88 / 0.92	0.88 / 0.92
	Power consumption	kW	0.088 / 0.088	0.112 / 0.112	0.112 / 0.112
	Starting current	A	0.87 / 0.87	1.23 / 1.23	1.26 / 1.26
Appearance		Heat-insulating material attached Zinc hot dipping steel plate			
Outer dimension	Height	mm	319	319	319
	Width	mm	840	840	840
	Depth	mm	840	840	840
Total weight	kg	25	25	25	
Heat exchanger		Finned tube			
Soundproof/Heat-insulating material		Non-flammable insulation			
Fan unit	Fan	Turbo fan			
	Standard air flow (-M -L)	m ³ /h	1970 (-1430 -1070)	2130 (-1430 -1130)	2130 (-1520 -1230)
	Motor	W	68	72	72
Air filter		Standard filter (Long life filter)			
Controller		(*2)	Remote controller		
Connecting pipe	Gas side	mm	Ø15.9	Ø15.9	Ø15.9
	Liquid side	mm	Ø9.5	Ø9.5	Ø9.5
Drain port (Nominal dia. mm)		25 (Polyvinyl chloride tube)			
Sound pressure level	High(-Mid.-Low)	dB	43-38-32	46-38-33	46-40-33
Ceiling panel (*2)	Model name	RBC-U31PG(W)-E			
	Appearance(Color)	White (2.5GY9.0/0.5)			
	Outer dimension	mm	Height 30 x Width 950 x Depth 950		
	Total weight	kg	4.0		
Remote controller wiring		(200m or less) (200m - 500m)	VCTF 0.3mm ² (2cores) VCTF 0.5 to 2.0mm ² (2cores)		
Crossover wiring		(Up to 1000m) (Up to 2000m)	MVVS (Shield wire) 1.25mm ² × 2cores MVVS (Shield wire) 2.00mm ² × 2cores		
Option parts	Spacer for height adjustment	TCB-SP1602UE	TCB-SP1602UE	TCB-SP1602UE	
	Fresh-air chamber	TCB-GFC1602UE	TCB-GFC1602UE	TCB-GFC1602UE	
	Fresh-air inlet box	TCB-GB1602UE	TCB-GB1602UE	TCB-GB1602UE	
	Air-discharge direction kit	TCB-BC1602UE	TCB-BC1602UE	TCB-BC1602UE	
	Auxiliary fresh air flange	TCB-FF101URE2	TCB-FF101URE2	TCB-FF101URE2	

(*1) Cooling / heating capacity is based on single connection operation with standard piping length under Japanese Industrial Standard B 8615 Condition 1.

(*2) Remote controller and ceiling panel are sold separately.

2. CONSTRUCTION VIEWS (EXTERNAL VIEWS)

MMU-AP0092H, AP0122H

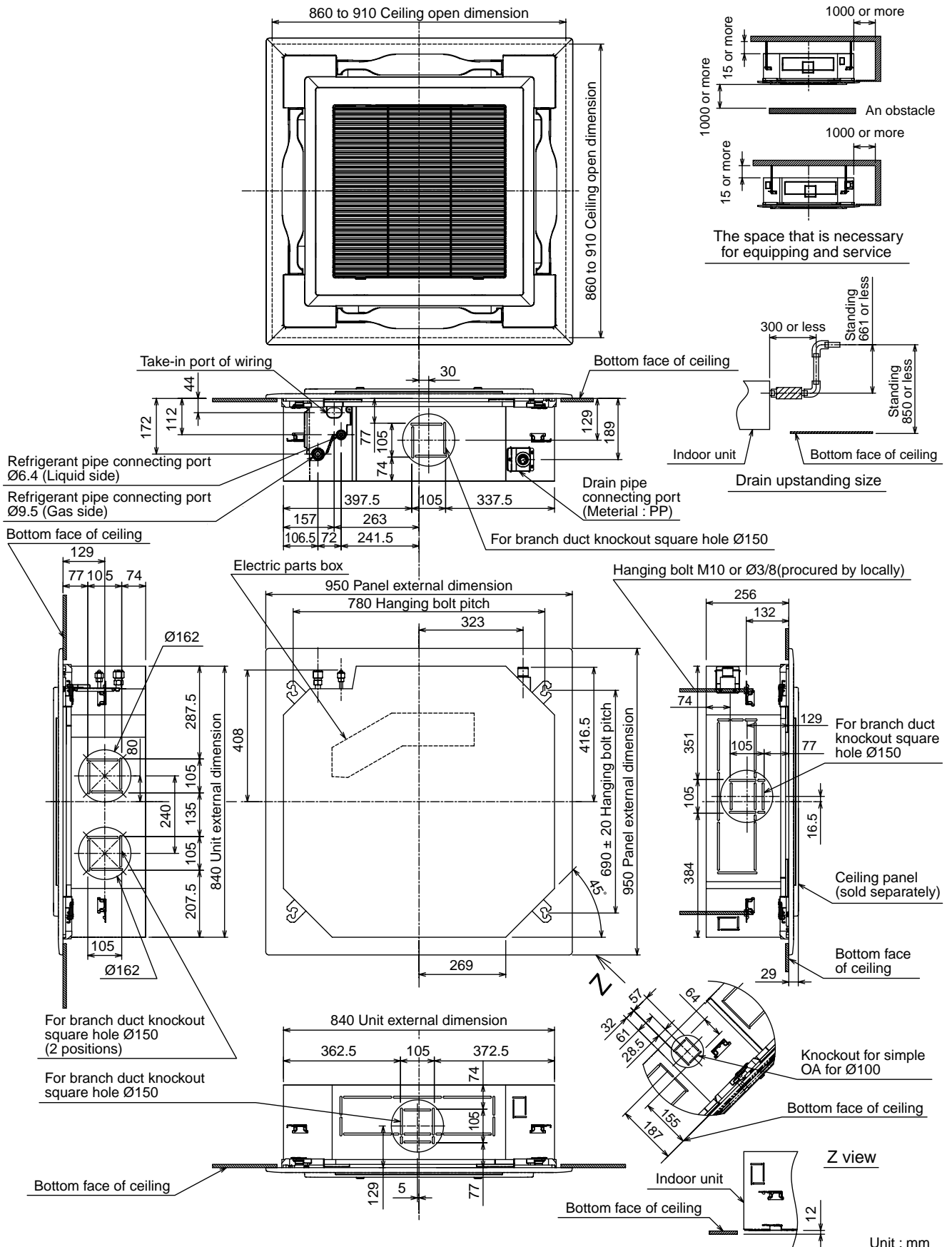

MMU-AP0152H, AP0182H

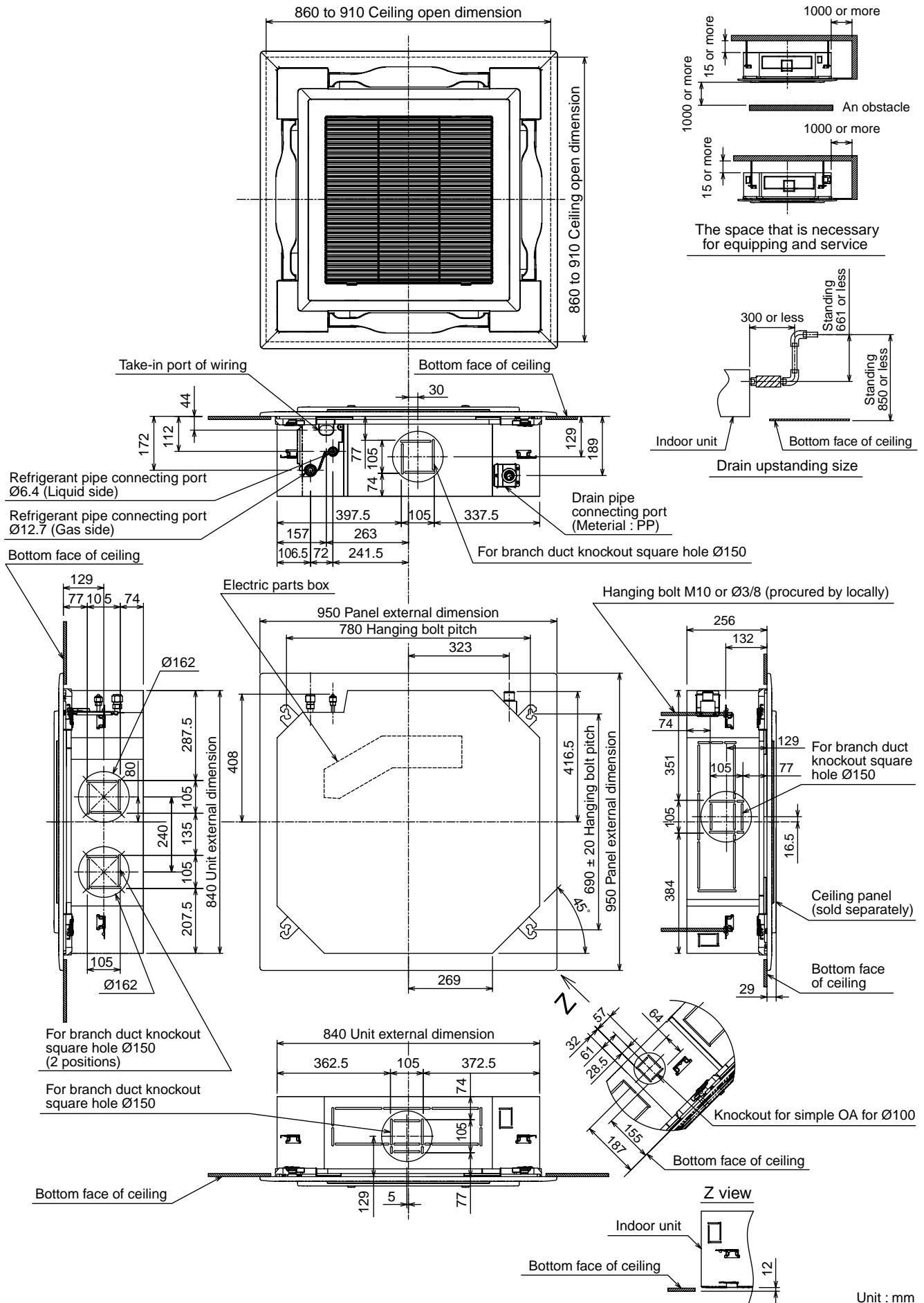

Unit : mm

MMU-AP0242H, AP0272H, AP0302H

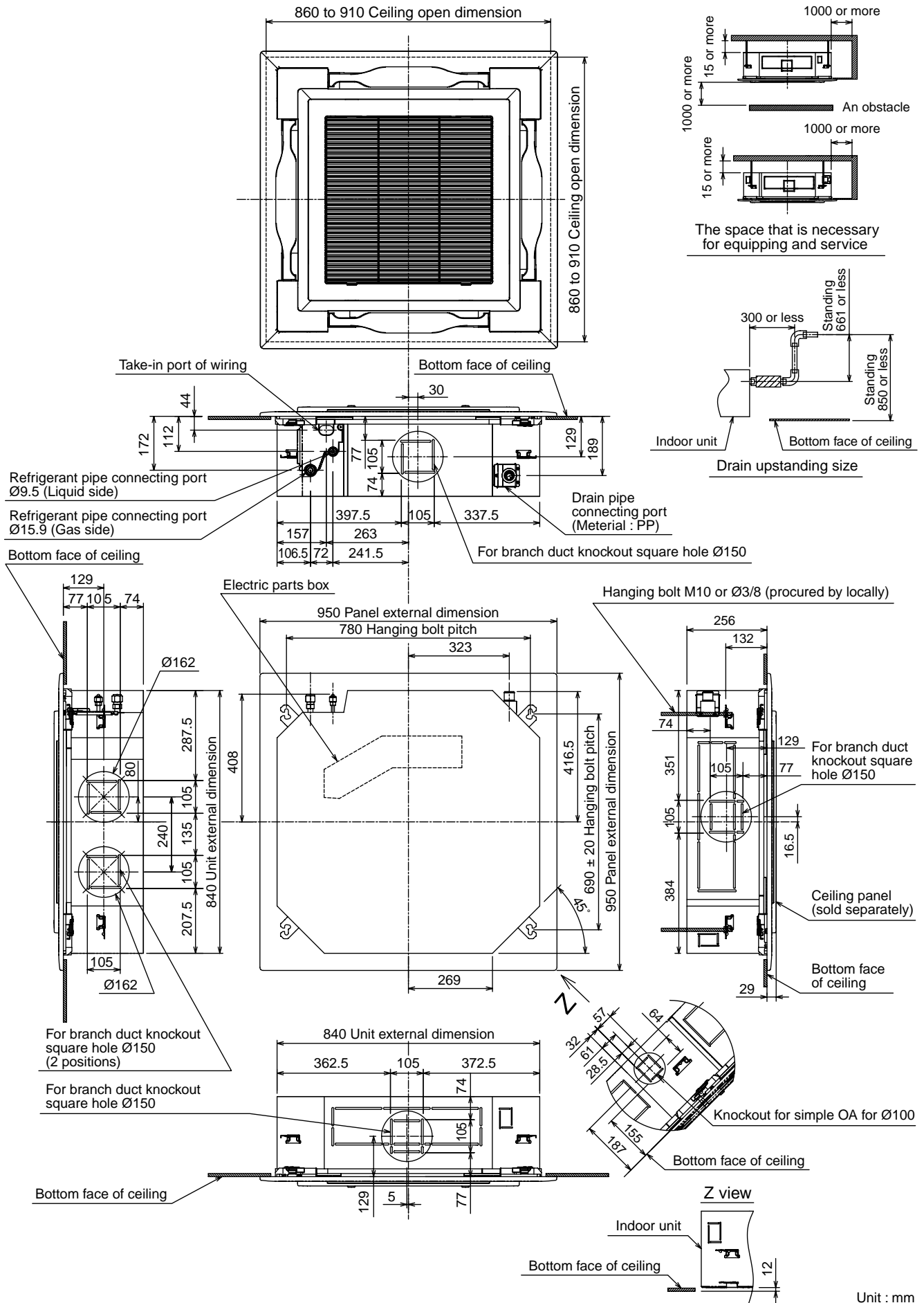

Unit : mm

MMU-AP0362H, AP0482H, AP0562H

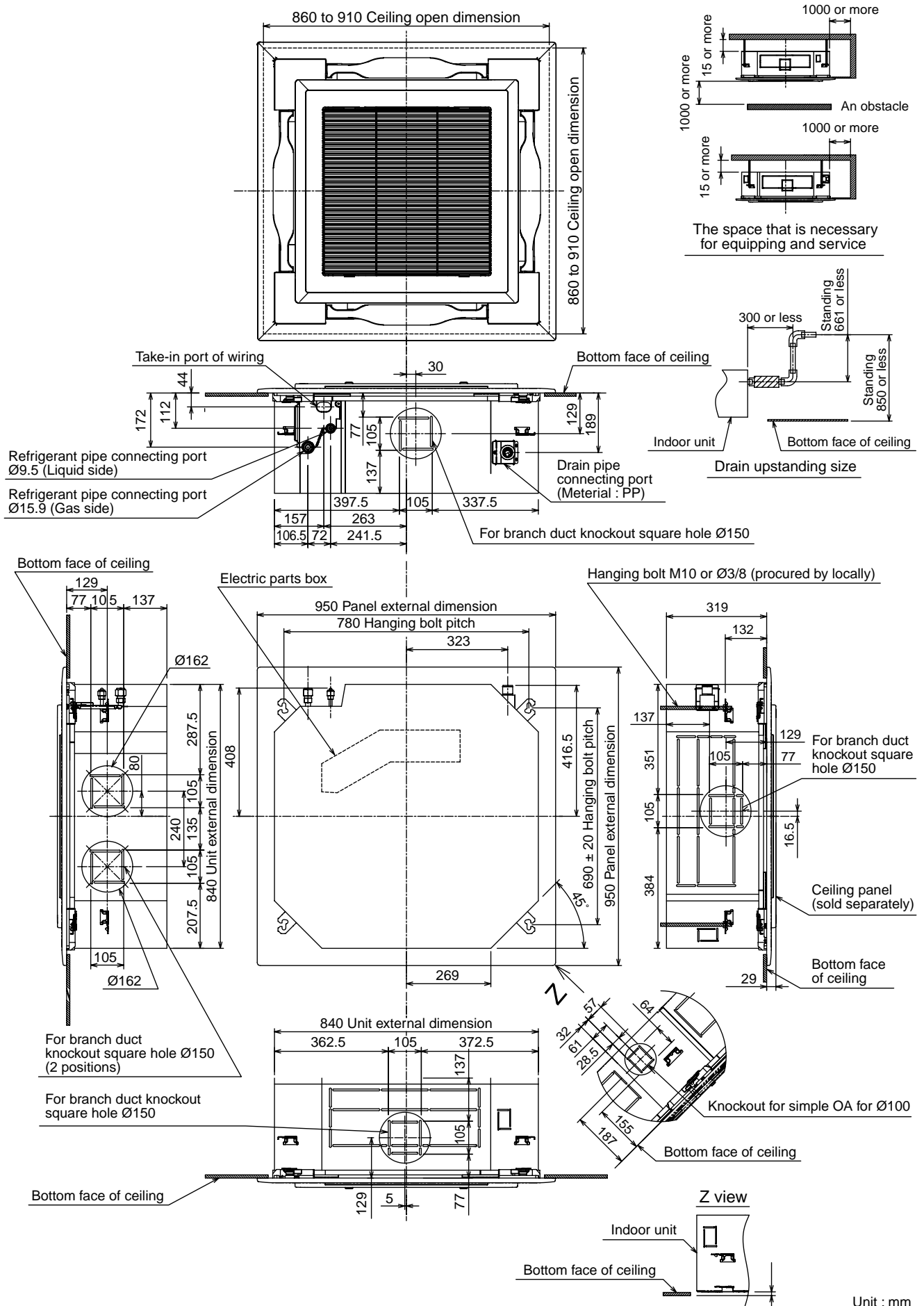

3. WIRING DIAGRAM

3-1. 4-Way Air Discharge Cassette Type

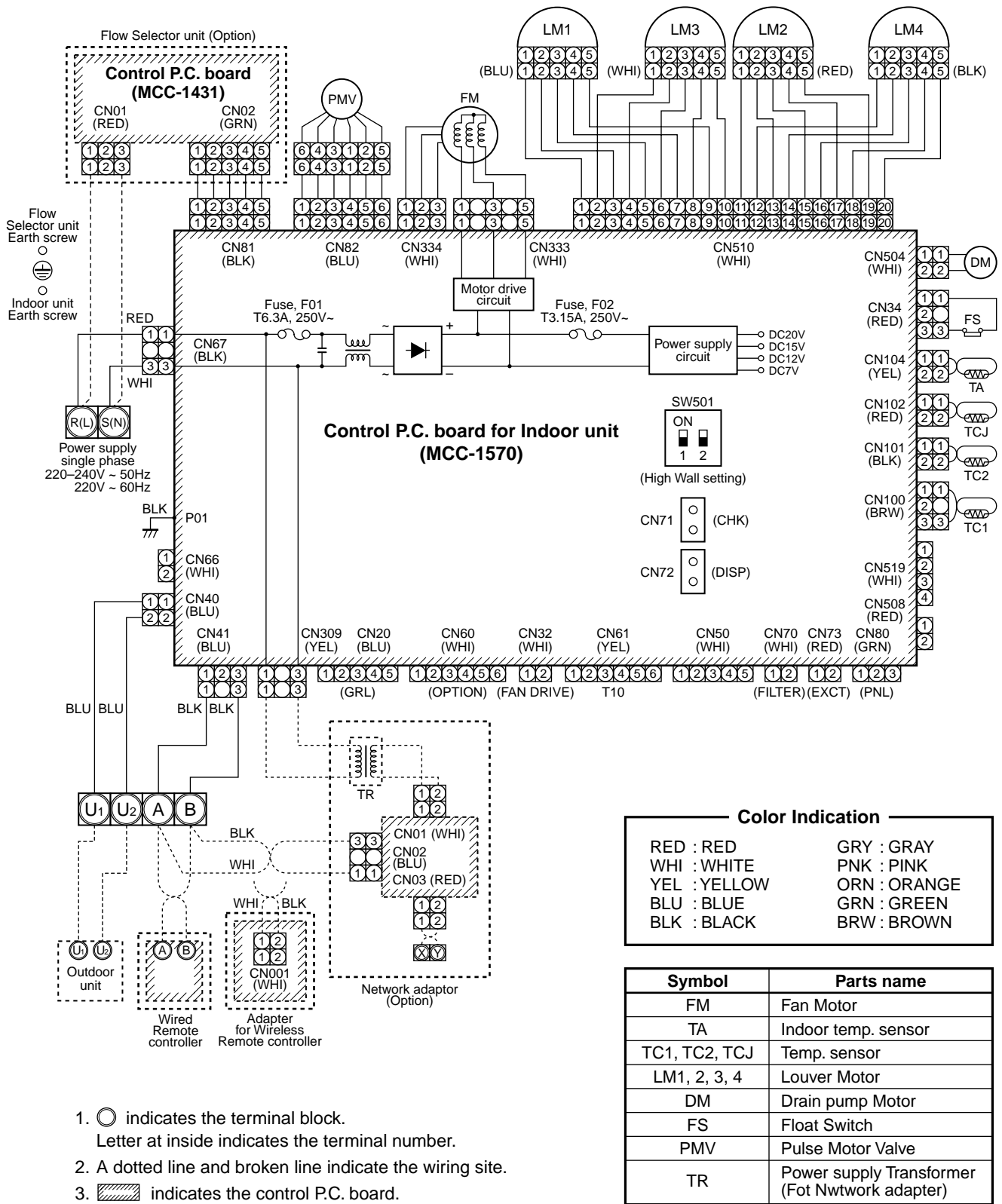

- indicates the terminal block.
Letter at inside indicates the terminal number.
- A dotted line and broken line indicate the wiring site.
- ▨ indicates the control P.C. board.

4. PARTS RATING

4-1. Parts Rating

Model	MMU-						
	AP0092H	AP0122H	AP0152H	AP0182H	AP0242H	AP0272H	AP0302H
Fan motor	SWF-230-60-2R						
Motor for horizontal grille	MP24ZN3N						
Pulse motor	EDM-MD12TF-3						
Pulse motor valve	EDM-B25YGTF-3			EDM-B40YGTF-2			
TA sensor	Lead wire length : 310 mm Vinyl tube						
TC1 sensor	Ø4 size lead wire length : 1200 mm Vinyl tube (Blue)						
TC2 sensor	Ø6 size lead wire length : 1000 mm Vinyl tube (Black)						
TCJ sensor	Ø6 size lead wire length : 1000 mm Vinyl tube (Red)						
Float switch	FS-0218-102						
Drain pump motor	MDP-1401						

Model	MMU-		
	AP0362H	AP0482H	AP0562H
Fan motor	ICF-280-150-1		
Motor for horizontal grille	MP24ZN3N		
Pulse motor	EDM-MD12TF-3		
Pulse motor valve	EDM-B60YGTF-1		
TA sensor	Lead wire length : 310 mm Vinyl tube		
TC1 sensor	Ø4 size lead wire length : 1200 mm Vinyl tube (Blue)		
TC2 sensor	Ø6 size lead wire length : 1000 mm Vinyl tube (Black)		
TCJ sensor	Ø6 size lead wire length : 1000 mm Vinyl tube (Red)		
Float switch	FS-0218-103		
Drain pump motor	MDP-1401		

4-2. Name of Each Part

Air outlet / Louver

Change the direction of the air to be discharged according to cool/heat mode.

Knob

Knob to open/close the air inlet grille.

Air inlet

The air in the room is sucked in from this port.

Earth screw

Provided in the electric parts box.

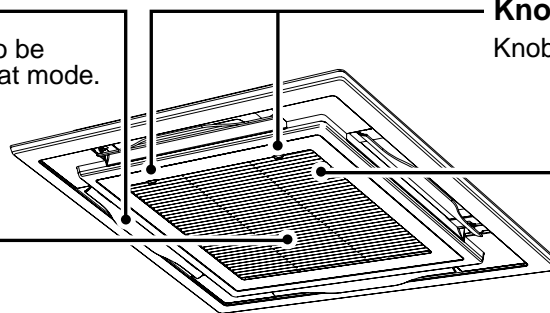

4-3. Parts Name of Remote Controller

■ Display section

In the display example, all indicators are displayed for the explanation. In reality only, the selected contents are indicated.

- When turning on the main power switch and leak breaker at the first time, **SETTING** flashes on the display part of the remote controller.
- While this display is flashing, the model is being automatically confirmed. Accordingly, wait for a while after **SETTING** display has disappeared, and then use the remote controller.

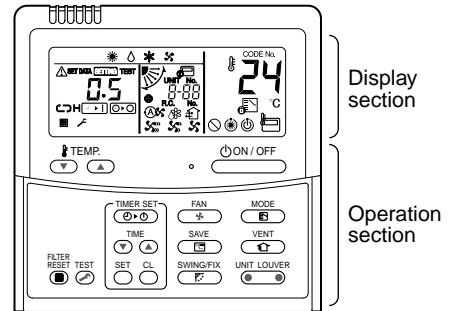

This remote controller can control the operation of Max. 8 indoor units.

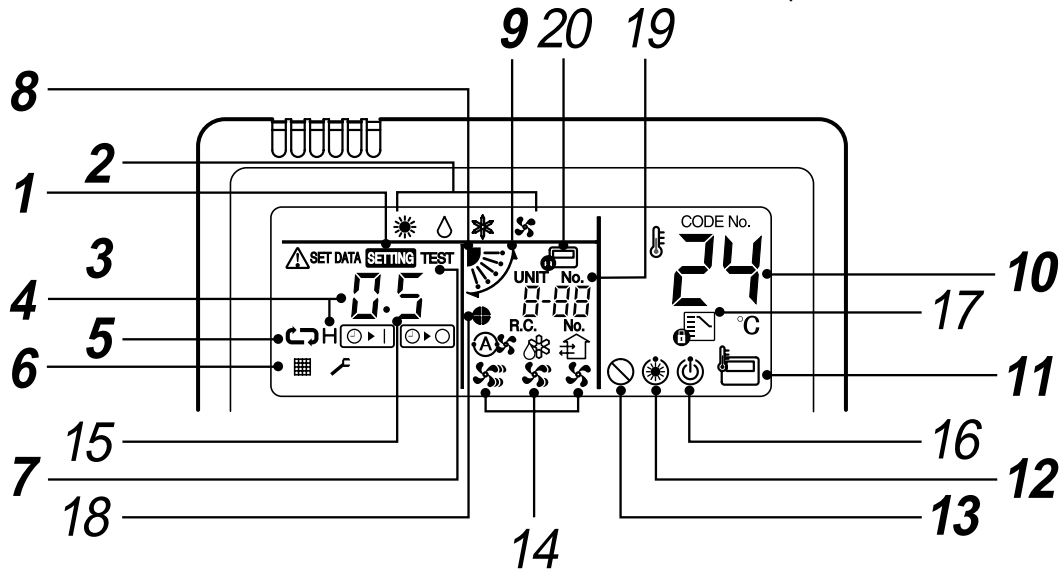

1 SETTING display

Displayed during setup of the timer etc.

2 Operation mode select display

The selected operation mode is displayed.

3 CHECK display

Displayed while the protective device works or a trouble occurs.

4 Timer time display

Time of the timer with H mark is displayed. (When a trouble occurs, the check code is displayed.)

5 Timer SET IN setup display

When pushing the Timer SET IN button, the display of the timer is selected in order of [OFF] [ON] → [OFF] repeat OFF timer → [ON] → No display.

6 Filter display

If "FILTER" is displayed, clean the air filter.

7 TEST run display

Displayed during a test run.

8 Louver position display

(4-way Air Discharge Cassette, 2-way Air Discharge Cassette, 1-way Air Discharge Cassette, Under Ceiling and High Wall Type only (2H, 3H))

Displays louver position.

9 SWING display

Displayed during up/down movement of the louver.

10 Set up temperature display

The selected set up temp. is displayed.

11 Remote controller sensor display

Displayed while the sensor of the remote controller is used.

12 PRE-HEAT display (Heat-pump model only)

Displayed when the heating operation starts or defrost operation is carried out.

While this indication is displayed, the indoor fan stops or the mode enters in LOW.



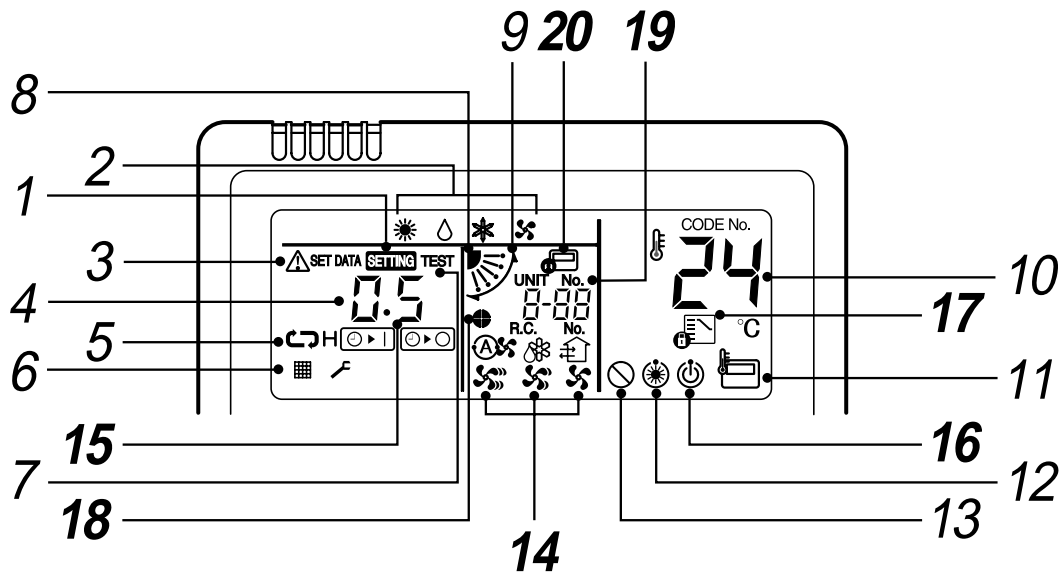

13 No function display

Displayed if there is no function even if the button is pushed.



14 Air volume select display

The selected air volume mode is displayed.

(AUTO)  (HIGH) 
(MED.)  (LOW) 

15 Louver Number display (example: 01, 02, 03, 04)

16 Operation ready display

Displayed when cooling or heating operation is impossible because the outdoor temperature goes out of the operable range.

17 Mode select control display

Displayed when pushing "Operation mode select" button while the operation mode is fixed to heating or cooling by the system manager of the air conditioner.

18 Louver lock display (4-way Air Discharge Cassette Type 2H series only)

Displayed when there is a louver-locked unit in the group (including 1 indoor unit by 1 outdoor unit).

19 Unit Number display

Unit number of the indoor unit selected with the unit select button or abnormal indication of the indoor/outdoor unit.

20 Central control display

Displayed when the air conditioner is used under the central control in combination with a central control remote controller.

In case the remote controller is disabled by the central control system,  flashes.

The button operation is not accepted.

Even when you push ON/OFF, MODE, or TEMP. button, the button operation is not accepted. (Settings made by the remote controller vary with the central control mode. For details, refer to the Owner's Manual of the central control remote controller.)

■ Operation section

Push each button to select a desired operation.

- The details of the operation needs to be set up once, afterward, the air conditioner can be used by pushing  button only.

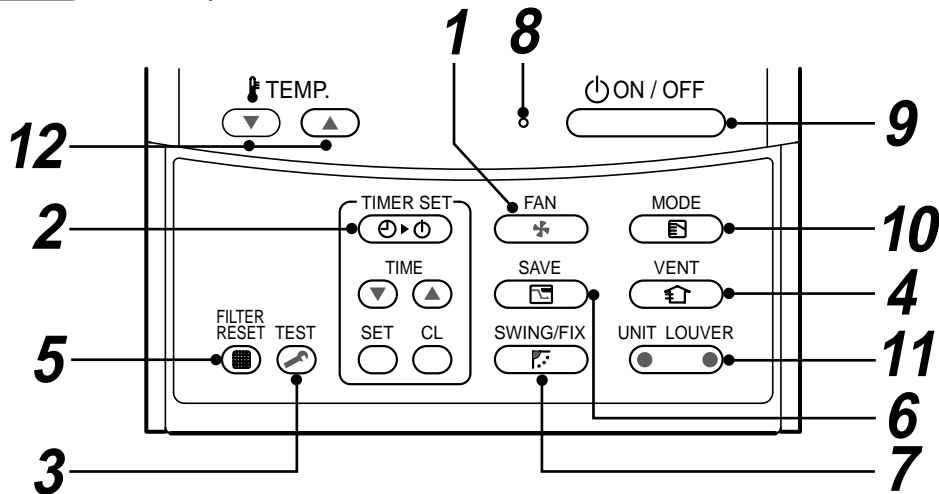

1 button (Air volume select button)

Selects the desired air volume mode.

2 button (Timer set button)

TIMER SET button is used when the timer is set up.

3 button (Check button)

The CHECK button is used for the check operation.

During normal operation, do not use this button.

4 button (Ventilation button)

Ventilation button is used when a fan which is sold on the market is connected.

- If “No function  ” is displayed on the remote controller when pushing the Ventilation button, a fan is not connected.

5 button (Filter reset button)

Resets (Erases) “  FILTER ” display.

6 button (Power save operation)

No function

7 button (Swing/Wind direction button)

Selects automatic swing or setting the louver direction.

- This function is not provided to Concealed Duct Standard Type, High Static Pressure Type, Floor Standing Cabinet Type, Floor Standing Concealed Type, or Slim Duct Type.

8 Operation lamp

Lamp is lit during the operation.

Lamp is off when stopped.

Also it flashes when operating the protection device or abnormal time.

9 button

When the button is pushed, the operation starts, and it stops by pushing the button again.

When the operation has stopped, the operation lamp and all the displays disappear.

10 button (Operation mode select button)

Selects desired operation mode.

11 button (Unit/Louver select button)

Selects a unit number (left) and louver number (right).

UNIT:



Selects an indoor unit when adjusting wind direction when multiple indoor units are controlled with one remote controller.

LOUVER (4-way Air Discharge Cassette Type 2H series only):

Selects a louver when setting louver lock or wind direction adjustment independently.

12 button (Set up temperature button)

Adjusts the room temperature.

Set the desired set temperature by pushing  TEMP.  .

OPTION :

Remote controller sensor

Usually the TEMP. sensor of the indoor unit senses the temperature. The temperature on the surrounding of the remote controller can also be sensed.

For details, contact the dealer from which you have purchased the air conditioner.

- In case that one remote controller controls the multiple indoor units, the setup operation is unavailable in group control.

4-4. Correct Usage

- When you use the air conditioner for the first time or when you change the SET DATA value, follow the procedure below. From the next time, the operation displayed on the remote controller will start by pushing the  button only.

■ Preparation

Turn on the main power switch and/or the leakage breaker.

- When the power supply is turned on, a partition line is displayed on the display part of the remote controller.
- * After the power supply is turned on, the remote controller does not accept an operation for approx. 1 minute, but it is not a failure.

REQUIREMENT



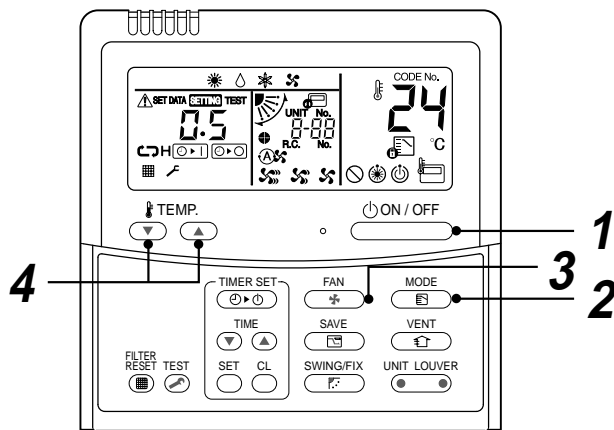



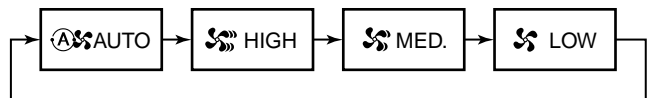

- While using the air conditioner, operate it only with  button without turning off the main power switch and the leak breaker.
- When you use the air conditioner after it has not been used for a long period, turn on the power switch at least 12 hours before starting operation.



3 Select air volume with “ ” button.

One push of the button, and the display changes in the order shown as follows.



- When air volume is “  AUTO”, air volume differs according to the room temperature.
- In  DRY mode, “  AUTO” is displayed and the air volume is LOW.
- In heating operation, if the room temperature is not heated sufficiently with VOLUME “  LOW” operation, select “  MED.” or “  HIGH” operation.
- The temperature sensor senses temperature near the air inlet of the indoor unit, which differs from the room temperature depending on the installation condition.
A value of setting temperature is the measure of room temperature. (“  AUTO” is not selectable in the FAN mode.)
- Air volume of function is not provided to “Concealed Duct High Static Pressure Type” but air speed “  HIGH” only is displayed.

4 Determine the set up temperature by pushing the “TEMP. ” or “TEMP. ” button.

Start

1 Push button.

The operation lamp goes on, and the operation starts.

2 Select an operation mode with the “MODE ” button.

One push of the button, and the display changes in the order shown as follows.

- “  DRY mode” function is not provided to Concealed Duct High Static Pressure Type.

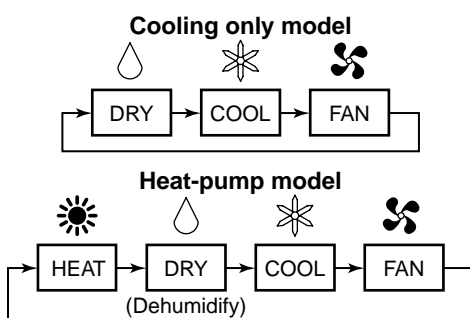

Stop

Push  button.

The operation lamp goes off, and the operation stops.

[In case of cooling]

- Start the cooling operation after approx. 1 minute.

[In case of heating (For Heat-pump model only)]

- The heating operation mode is selected in accordance with the room temperature and operation starts after approximately 3 to 5 minutes.
- After the heating operation has stopped, FAN operation may continue for approx. 30 seconds.
- When the room temperature reaches the set temperature, the super low wind is discharged and the air volume decreases excessively.
- During defrost operation, the fan stops so that cool air is not discharged. (“❄️ PRE-HEAT” is displayed.)

NOTE

When restarting the operation after stop

- When restarting the operation immediately after stop, the air conditioner does not operate for approx. 3 minutes to protect the machine.

4-5. Automatic Operation (Super Heat Recovery Type Only)

When you set the air conditioner in **A** mode or switch over from AUTO operation because of some settings change, it will automatically select either cooling, heating, or fan only operation depending on the indoor temperature.

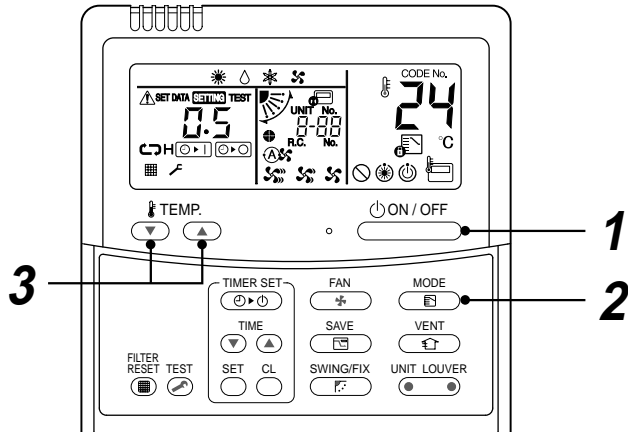

3 Temperature button

Set the desired temperature.

- In case of cooling, start the operation after approx. 1 minute.
- In case of heating, the operation mode is selected in accordance with the room temperature and operation starts after approximately 3 to 5 minutes.
- When you select the Auto mode, it is unnecessary to set the fan speed. The FAN speed display will show AUTO and the fan speed will be automatically controlled.
- After the heating operation has stopped, FAN operation may continue for approx. 30 seconds.
- When the room temperature reaches the set temperature and the outdoor unit stops, the super low wind is discharged and the air volume decreases excessively. During defrost operation, the fan stops so that cool air is not discharged and “HEAT READY” is displayed.
- If the Auto mode is uncomfortable, you can select the desired conditions manually.

Start

- 1** **ON/OFF button**
Push this button to start the air conditioner.
- 2** **Mode select button (MODE)**
Select Auto **A**.

NOTE

When restarting the operation after stop

- When restarting the operation immediately after stop, the air conditioner does not operate for approx. 3 minutes to protect the machine.

Stop

- Push **ON/OFF button**.
Push this button again to stop the air conditioner.

4-6. Adjustment of Wind Direction

For best cooling and heating performance, adjust the louvers (adjustment of up/down wind direction) appropriately.

CAUTION

- If cooling operation is performed with downward air outlet, dew may fall on surface of the cabinet or the horizontal louver resulted in dripping.
- If heating operation is performed with horizontal air outlet, unevenness of temperature may increase in the room.
- Do not move the horizontal louver directly with hands; otherwise a trouble is caused.
Select direction of the horizontal louver using  switch on the remote controller. The horizontal louver does not stop immediately even if the switch is pushed. Adjusting the stop position, push the switch.

◆ For all models

[In Cooling operation]

Use the louvers with horizontal set point.

[In Heating operation (For Heat-pump model only)]

Use the louvers with downward set point.

◆ For Under Ceiling, 1-way Air Discharge Cassette, High Wall Type

[Right / Left air direction adjustment]

To change the air outlet direction to right or left side, set the vertical louver inside of the horizontal louver to the desired direction.

◆ 4-way Air Discharge Cassette Type (1H series), Compact 4-way Type

- When the air conditioner is not operating, the louvers automatically direct downward.
- While the air conditioner is in ready status for heating, the louvers direct upward.
The swinging operation starts after heating ready status has been cleared, but “SWING  ” is displayed on the remote controller even if the status is ready to heating.

◆ 4-way Air Discharge Cassette Type (2H series)

- When the air conditioner is not operating, the louvers automatically close.
- The louvers direct horizontally when heating begins, during defrost operation, or during the minimum operation after reaching the set temperature. When you make a swing or air direction setting at this time, the remote controller display varies with the setting, but the louvers stay pointed straight out horizontally. When the air conditioner starts heating, the louvers direct to the set direction.
- As the refrigerant recovery control for the outdoor units in the Modular Multi system works even if the outdoor units stop, in some cases, the louver of the stopped indoor unit may open for several minutes.

[In Cooling operation]

Use the louvers with horizontal set point.

For Cooling (Cool)

Direct the louvers horizontally.

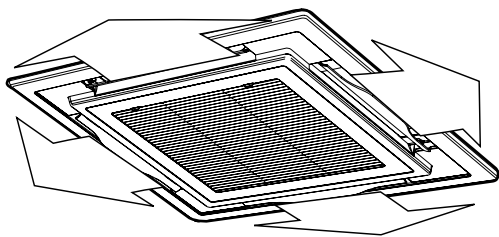

[In Heating operation (For Heat-pump model only)]

Use the louvers with downward set point.

For Heating (Heat)

Direct the louvers downward.

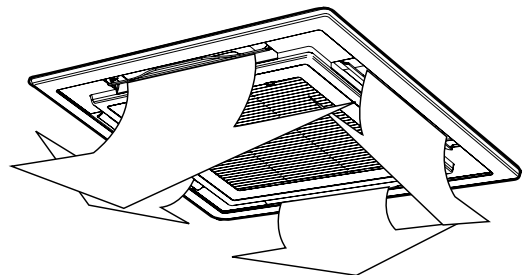

According to the shape or arrangement of the room, the cold air and hot air can be discharged for two directions or three directions. For details, contact the dealer.

◆ 4-way Air Discharge Cassette, 1-way Air Discharge Cassette (2SH series), Under CeilingType

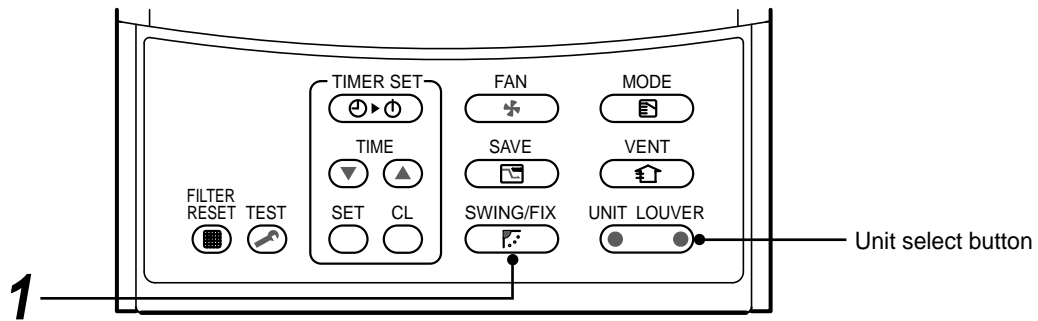

■ How to set up the wind direction

1 Push during operation.

The wind direction changes for every push of the button.

[In HEAT operation (For Heat-pump model only)]

Direct the louver (adjustment plate of up/down wind direction) downward.

If directing horizontally, hot air may not come to the foot.

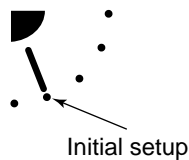

[In COOL/DRY operation]

Direct the louver (adjustment plate of up/down wind direction) horizontally.

If directing it downward, the dew may form on the surface of the air discharge port and may drop down.

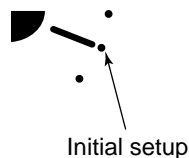

[In FAN operation]

Select a desired wind direction.

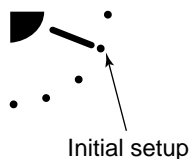

■ How to stop swinging

1 Push at a desired position while the louver is swinging.

- When  is pushed after that, wind direction can be set again from the highest position.

* However, even if  is pushed while the louver is swinging, the louver position is displayed as follows and highest position of the louver may not be selected.

Display when swinging is stopped



In this case, push  again two seconds later.

- In COOL/DRY operation, the louver does not stop as it directs downward. If stopping the louver as it directs downward during swing operation, it stops after moving to the third position from the highest position.

Display when stopping the swing



■ How to start swinging



1 Push , set the louver (adjustment plate of up/down wind direction) direction to the lowest position, and then push again.

SWING  is displayed and the up/down wind direction is automatically selected.

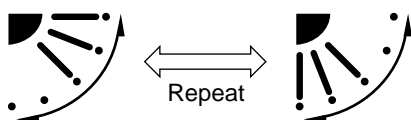
Display during swinging



Unit select button

- When multiple indoor units are controlled with one remote controller, wind direction can be set for each indoor unit by selecting individually.
- To set wind direction individually, push  button to display an indoor unit number in the control group. Then set the wind direction of the displayed indoor unit.
- When no indoor unit number is displayed, all indoor units in the control group can be controlled simultaneously.
- Each time you push  button, the display changes as follows:

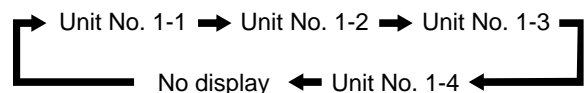

◆ 4-way Air Discharge Cassette Type (2H series only)

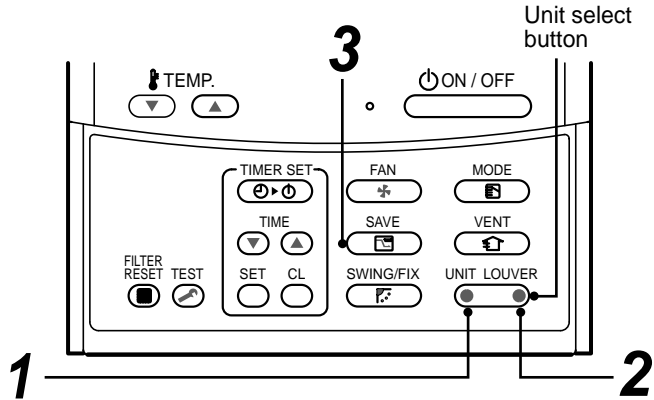

3 Determine wind direction of the selected louver by pushing .

- Each time you push the button, the display changes as follows:

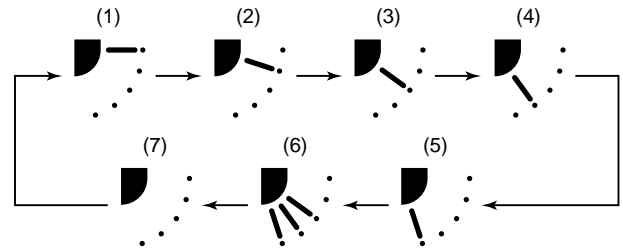

- * During COOL (DRY) mode, (4) and (5) are not displayed.

■ How to set louver wind direction individually

1 Select an indoor unit to be set by pushing (left side of the button) during operation.

- The indoor unit number changes each time you push the button.

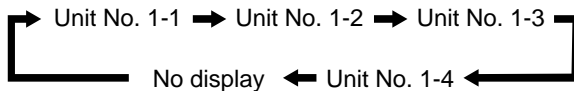

- * When no unit number is displayed, all indoor units are selected.

2 Select a louver you want to adjust change by pushing (right side of the button).

- Each time you push the button, the display on the left of the remote controller changes as follows:



- * When no louver number is displayed, all four louvers are selected.

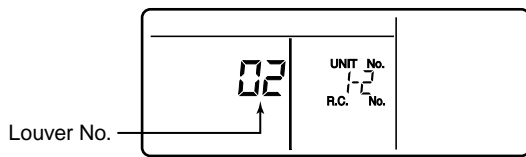

03

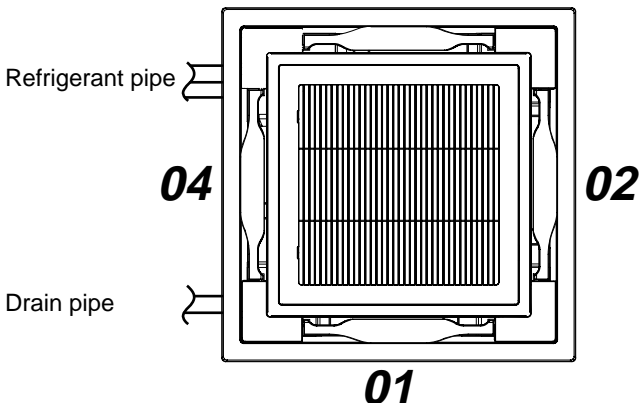

◆ 2-way Air Discharge Cassette, 1-way Air Discharge Cassette Type (1YH series)

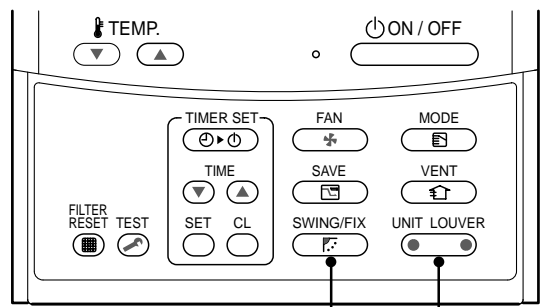

1,2 3

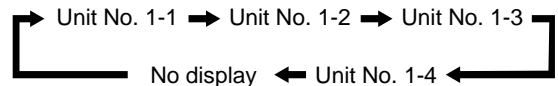

Setup of air direction and swinging

1 Push button during operation.



- [SWING ] is displayed and the air direction automatically changes upward/downward.

In case when one remote controller controls the multiple indoor units, each indoor unit can be selected and its air direction can be set up.

2 Push button again during swinging of the louver.

- The air outlet louver can be stopped at the desired position.

3

- To set up the air direction individually, push  button to display each indoor unit No. in a group control. Then set up the air direction to a displayed indoor unit.
- If there is no display, all the indoor units can be operated collectively.
- Every pushing  button, the display exchanges as shown in the figure.

4-7. Timer Operation

- A type of timer operation can be selected from the following three types. (Setting of up to 168 hours is enabled.)

OFF timer : The operation stops when the time of timer has reached the set time.

Repeat OFF timer : Every time, the operation stops after the set time has passed.

ON timer : The operation starts when the time of timer has reached the set time.

■ Timer operation

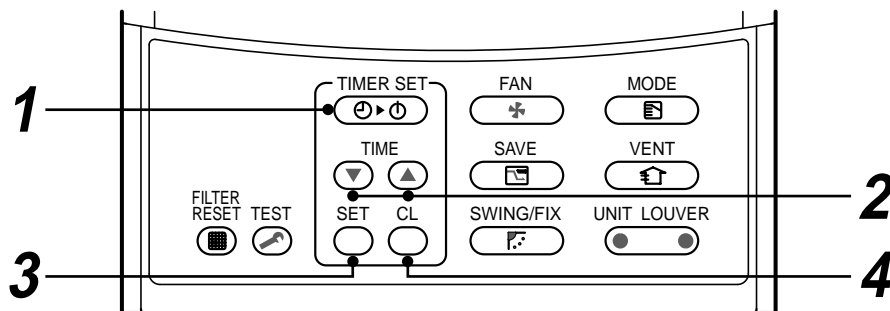

Set

1 Push TIMER SET button.

The timer display (type) changes for every push of the button.

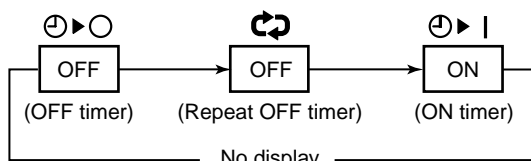

- SETTING** and timer time displays flash.

2 Push ^{TIME} to select "SET TIME".

- For every push of [▲] button, the set time increases in the unit of 0.5 hr (30 minutes).
When setting a time more than 24 hours for timer operation, timer time can be set in the unit of 1 hr.
The maximum set time is 168hr (7 days).
The remote controller displays the set time with time (between 0.5 and 23.5 hours) (*1) or number of days and time (24 hours or more) (*2) as shown below.
- For every push of [▼] button, the set time decreases in the unit of 0.5 hr (30 minutes) (0.5 to 23.5 hours) or 1 hr (24 to 168 hours).

Example of remote controller display

- In the case of 23.5 hours (*1)



- In the case of 34 hours (*2)

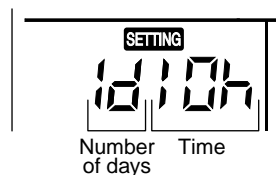

1d shows 1 day (24 hours).

10h shows 10 hours. (Total 34 hours).

3 Push SET button.

- SETTING** display disappears and timer time display goes on, and [▶] or [◀] display flashes.
(When ON timer is activated, timer time, ON timer [▶] are displayed and other displays disappear.)

4 Cancel of timer operation

Push ^{CL} button.

TIMER display disappears.

NOTE

- When the operation stops after the timer reached the preset time, the Repeat OFF timer resumes the operation by pushing ^{ON/OFF} button and stops the operation after the reached the set time.
- When you push ^{SWING/FIX} while the OFF timer function of the air conditioner is active, the indication of the timer function disappears and then appears again after about 5 seconds.
This is due to normal processing of the remote controller.

4-8. INSTALLATION

Installation place



-
- Check that the air conditioner is not installed in a place subject to combustible gas leak. Accumulation of combustible gas around the unit may cause a fire.
 - Drain the dehumidified water from the indoor unit and outdoor unit to a well-drained place.
 - Do not put any obstacle near the air inlets and air outlet of the outdoor unit. Doing so may hinder the radiation, which may reduce the performance or activate the protective device.
-

Electrical wiring



-
- Be sure to connect earth wire. (grounding work) Incomplete grounding cause an electric shock. Do not connect ground wires to gas pipes, water pipes, lightning rods or ground wires for telephone wires.
-



-
- **Make sure that a leakage breaker is connected.**
Using the air conditioner without leakage breaker may cause electric shock.
 - **Use a leakage breaker with an appropriate capacity.**
Be sure to use the rated voltage and an exclusive circuit for power supply of the air conditioner.
-

Do not install the air conditioner in the following places

- Do not install the air conditioner in any place within 1 m from a TV, stereo, or radio set.
If the unit is installed in such place, noise transmitted from the air conditioner affects the operation of these appliances.
- Do not install the air conditioner near a high frequency appliance (sewing machine or massager for business use, etc.), otherwise the air conditioner may malfunction.
- Do not install the air conditioner in a humid or oily place, or in a place where steam, soot, or corrosive gas is generated.
- Do not install the air conditioner in a salty place such as seaside area.
- Do not install the air conditioner in a place where a great deal of machine oil is used.
- Do not install the air conditioner in a place where it is usually exposed to strong wind such as in seaside area.
- Do not install the air conditioner in a place where sulfurous gas generated such as in a spa.
- Do not install the air conditioner in a vessel or mobile crane.
- Do not install the air conditioner in an acidic or alkaline atmosphere (in a hot-spring area or near a chemicals factory, or in a place subject to combustion emissions).
Corrosion may be generated on the aluminum fin and copper pipe of the heat exchanger.
- Do not install the air conditioner near an obstacle (air vent, lighting equipment, etc.) that disturbs discharge air. (Turbulent airflow may reduce the performance or disable devices.)
- Do not use the air conditioner for special purposes such as preserving food, precision instruments, or art objects, or where breeding animals or growing plants are kept. (This may degrade the quality of preserved materials.)
- Do not install the air conditioner over an object that must not get wet. (Condensation may drop from the indoor unit at a humidity of 80% or more or when the drain port is clogged.)
- Do not install the air conditioner in a place where an organic solvent is used.
- Do not install the air conditioner near a door or window subject to humid outside air. Condensation may form on the air conditioner.
- Do not install the air conditioner in a place where special spray is used frequently.

Be careful with noise or vibrations

- Do not install the air conditioner in a place where noise by outdoor unit or hot air from its air outlet annoys your neighbors.
- Install the air conditioner on a solid and stable foundation so that it prevents transmission of resonating, operation noise and vibration.
- If one indoor unit is operating, some sound may be audible from other indoor units that are not operating.

4-9. Maintenance

WARNING

Be sure to turn off the main power switch prior to the maintenance.

- Please do not intend to do the daily maintenance and/or Air Filter cleaning by yourself.

Cleaning of the air filter and other parts of the air filter involves dangerous work in high places, so be sure to have a service person do it. Do not attempt it yourself.

Daily maintenance

- For daily maintenance including Air Filter cleaning, make sure to ask the qualified service person particularly following models;

4-way Air Discharge Cassette Type

Concealed Duct Standard Type

Under Ceiling Type

2-way Air Discharge Cassette Type

Slim Duct Type

1-way Air Discharge Cassette Type

Concealed Duct High Static Pressure Type

Cleaning of air filters

Clogging of air filters will reduce the cooling and heating performance.

- 1 When “ FILTER” appears on the remote controller, clean the air filters.
- 2 When the cleaning of air filters has been completed, push  button. “ FILTER” disappears.

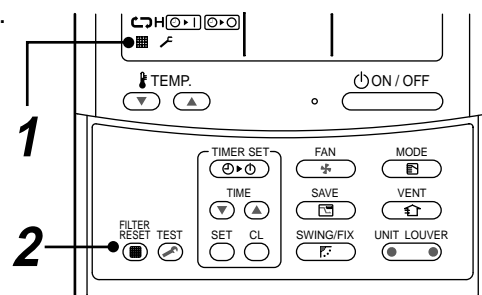

CAUTION

Cleaning of unit

Clean the unit with a soft dry cloth.

If dirt cannot be removed with the dry cloth, use a cloth slightly dampened with lukewarm (under 40 °C) water.

Cleaning of remote controller

- Use a dry cloth to wipe the remote controller.
- A cloth dampened with cold water may be used on the indoor unit if it is very dirty.
- Never use a damp cloth on the remote controller.
- Do not use a chemically-treated duster for wiping or leave such materials on the unit for long. It may damage or fade the surface of the unit.
- Do not use benzine, thinner, polishing powder, or similar solvents for cleaning.

These may cause the plastic surface to crack or deform.

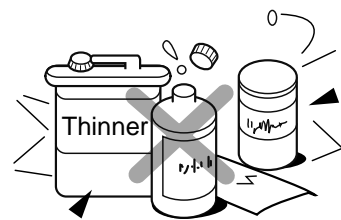

Periodic check

Long-period use of the air conditioner may cause deterioration or failure of parts due to heat, humidity, dust, and operating conditions, or may cause poor drainage of dehumidified water.

If you do not plan to use the unit for more than 1 month

- 1) Operate the fan for 3 to 4 hours to dry inside the unit.
 - Operate “FAN” mode.
- 2) Stop the air conditioner and turn off the main power switch or the circuit breaker.

Checks before operation

- 1) Check that the air filters are installed.
- 2) Check that the air outlet or inlet is not blocked.
- 3) Turn on the main power switch or the circuit breaker for the main power supply to the air conditioner.

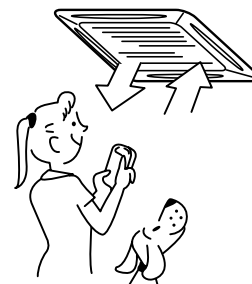

NOTE

- For environmental conservation, it is strongly recommended that the indoor and outdoor units of the air conditioner in use be cleaned and maintained regularly to ensure efficient operation of the air conditioner. When the air conditioner is operated for a long time, periodic maintenance (once a year) is recommended. Furthermore, regularly check the outdoor unit for rust and scratches, and remove them or apply rustproof treatment, if necessary.

As a general rule, when an indoor unit is operated for 8 hours or more daily, clean the indoor unit and outdoor unit at least once every 3 months. Ask a professional for this cleaning/maintenance work.

Such maintenance can extend the life of the product though it involves the owner's expense.

Failure to clean the indoor and outdoor units regularly will result in poor performance, freezing, water leakage, and even compressor failure.

Maintenance List

Part	Check (visual/auditory)	Maintenance
Heat exchanger	<ul style="list-style-type: none">• Dust/dirt clogging, scratches	<ul style="list-style-type: none">• Wash the heat exchanger when it is clogged.
Fan motor	<ul style="list-style-type: none">• Sound	<ul style="list-style-type: none">• Take appropriate measures when abnormal sound is generated.
Filter	<ul style="list-style-type: none">• Dust/dirt, breakage	<ul style="list-style-type: none">• Wash the filter with water when it is contaminated.• Replace it when it is damaged.
Fan	<ul style="list-style-type: none">• Vibration, balance• Dust/dirt, appearance	<ul style="list-style-type: none">• Replace the fan when vibration or balance is terrible.• Brush or wash the fan when it is contaminated.
Air inlet/outlet grilles	<ul style="list-style-type: none">• Dust/dirt, scratches	<ul style="list-style-type: none">• Fix or replace them when they are deformed or damaged.
Drain pan	<ul style="list-style-type: none">• Dust/dirt clogging, drain contamination	<ul style="list-style-type: none">• Clean the drain pan and check the downward slope for smooth drainage.
Ornamental panel, louvers	<ul style="list-style-type: none">• Dust/dirt, scratches	<ul style="list-style-type: none">• Wash them when they are contaminated or apply repair coating.

WARNING

Re-Installation

Ask the dealer or an installation professional to re-install the air conditioner to a new place or move it to another place and to observe the following items.

If the air conditioner is inappropriately installed by yourself, it may cause electric shock or fire.

CAUTION

Be sure to clean the heat exchanger with pressurized water.

If an commercially detergent (strong alkaline or acid cleaning agent) is used, the surface treatment of the heat exchanger will be marred, which may degrade the self cleaning performance. For details, contact the dealer.

4-10. Air Cinditioner Operations and Performance

Check before operation

- Check whether earth wire is disconnected or out of place.
- Check that air filter is installed to the indoor unit.
- Check that the air outlet or inlet is not blocked.
- Turn on the main power switch or the circuit breaker for the main power supply to the air conditioner.



WARNING

Turn on the power switch 12 hours or more before starting before operation.

Heating capacity (for Heat-pump model only)

- For heating, a heat pump system which sucks in outside heat air and discharges it into the room is adopted. If temperature of the outside air lowers, the heating capacity decreases.
- When temperature of the outside air is low, it is recommended to use other heating equipment together.

Defrost operation during heating operation (for Heat-pump model only)

- If the outdoor unit has some frost during heating operation, the operation mode changes automatically to defrost mode to increase the heating effect (for approx. 2 to 10 minutes).
- During defrost operation, fans of the indoor and the outdoor units stop.

3 minutes protection

- The outdoor unit does not operate for approx. 3 minutes after air conditioner has been immediately restarted after stop, or power switch has been turned on. This is to protect the system.

Main power failure

- If a power failure occurred during the operation, all operations stop.
- When restarting the operation, push ON/OFF button again.

Fan rotation of stopped unit

- While other indoor units operate, the fan on indoor units on "stand-by" rotates to protect the machine once per approx. 1 hour for several minutes.

Protective device (High pressure switch)

The high pressure switch stops the air conditioner automatically when excessive load is applied to the air conditioner. If the protective device works, the operation lamp keeps lit but the operation stops. When the protective device works, "▲" in the remote controller display part flash. The protective device may work in the following cases.

<Cooling operation>

- When the air inlet or air outlet of the outdoor unit is blocked.
- When strong wind blows continuously against the air outlet of the outdoor unit.

<Heating operation>

- When dust or dirt is excessively adhered to air filter of the indoor unit.
- When the air outlet of the indoor unit is blocked.

Cooling/heating operation of Modular Multi system air conditioner

- In Modular Multi system air conditioner, each indoor unit can be individually controlled. However, cooling operation and heating operation cannot be performed concurrently for the indoor units which are connected to one outdoor unit. When cooling operation and heating operation are performed concurrently, the indoor unit which is performing cooling operation stops, and "⊙" on the display is lit. The indoor unit which is performing heating operation continues operation. If the manager has fixed the setting to COOL or HEAT, other operation than set up one cannot be performed. When other operation than set up one is performed, "⊙" on the display is lit and the operation stops.

Characteristics of heating operation (for Heat-pump model only)

- Hot air is not out immediately after the operation has started. After 3 to 5 minutes (differs according to room or outside temperature) has passed and the indoor heat exchanger has been warmed up, hot air blows out.
- During operation, the outdoor unit may stop if outside temperature becomes high.
- When other outdoor unit performs heating operation while the fan is operating, the fan operation may be stopped temporarily to prevent blowing of hot air.

Air conditioner operating conditions

For proper performance, operate the air conditioner under the following temperature conditions:

Cooling operation	Outdoor temperature : -5°C to 43°C (Dry-bulb temp.)
	Room temperature : 21°C to 32°C (Dry-bulb temp.), 15°C to 24°C (Wet-bulb temp.)
	CAUTION Room relative humidity: less than 80 %. If the air conditioner operates in excess of this figure, the surface of the air conditioner may cause dewing.
Heating operation	Outdoor temperature : -15°C to 15.5°C (Wet-bulb temp.)
	Room temperature : 15°C to 28°C (Dry-bulb temp.)

If air conditioner is used outside of the above conditions, safety protection may operate.

4-11. When the Following Symptoms Are Found

Check the points described below before asking repair servicing.

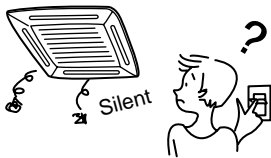
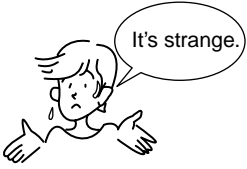
	Symptom	Cause
It is not a failure.	Outdoor unit <ul style="list-style-type: none"> • White misty cold air or water is out. • Sometimes, noise "Pushu !" is heard. 	<ul style="list-style-type: none"> • Fan of the outdoor unit stops automatically and performs defrost operation. • Solenoid valve works when defrost operation starts or finishes.
	Indoor unit <ul style="list-style-type: none"> • "Swish" sound is heard sometimes. • Slight "Pishi!" sound is heard. • Discharge air smells. • "Ⓜ" indication is lit.  <ul style="list-style-type: none"> • Sound or cool air is output from the stand by indoor unit. <ul style="list-style-type: none"> • When power of the air conditioner is turned on, "Ticktock" sound is heard. • Fan and louvers of the indoor unit moves when the unit is not operated. 	<ul style="list-style-type: none"> • When the operation has started, during the operation, or immediately after the operation has stopped, a sound such as water flows may be heard, and the operation sound may become larger for 2 or 3 minutes immediately after the operation has started. They are flowing sound of refrigerant or draining sound of dehumidifier. • This is sound generated when heat exchanger, etc. expand and contract slightly due to change of temperature. • Various smell such as one of wall, carpet, clothes, cigarette, or cosmetics adhere to the air conditioner. • When cooling operation cannot be performed because another indoor unit performs heating operation. • When the manager of the air conditioner has fixed the operation to COOL or HEAT, and an operation contrary to the setup operation is performed. • When fan operation stopped to prevent discharge of hot air. • Since refrigerant is flowed temporarily to prevent stay of oil or refrigerant in the stand by indoor unit, sound of flowing refrigerant, "Kyururu" or "Shaa" may be heard or white steam when other indoor unit operates in HEAT mode, and cold air in COOL mode may be blow-out. • Sound is generated when the expansion valve operates when power has been turned on. • Intermittent operation of the fan with louvers open is sometimes carried out for the refrigerant recovery control of unoperated unit.
Check again.	Operates or stops automatically.	<ul style="list-style-type: none"> • Is the timer "ON" or "OFF"?
	Does not operate. 	<ul style="list-style-type: none"> • Is it a power failure? • Is the power switch turned off? • Is the power fuse or breaker blown? • Has the protective device operated? (The operation lamp goes on.) • Is the timer "ON"? (The operation lamp goes on.) • Are COOL and HEAT selected simultaneously? ("Ⓜ" indication is lit on the display of the remote controller.)
	Air is not cooled or warmed sufficiently. 	<ul style="list-style-type: none"> • Is the air inlet or air outlet of the outdoor unit obstructed? • Are any door or window open? • Is the air filter clogged with dust? • Is discharge louver of the indoor unit set at appropriate position? • Is air selection set to "LOW" "MED", and is the operation mode set to "FAN"? • Is the setup temp. the appropriate temperature? • Are COOL and HEAT selected simultaneously? ("Ⓜ" indication is lit on the display of the remote controller.)

CAUTION

If any of the following conditions occur, turn off the main power supply switch and immediately contact the dealer :

- Switch operation does not work properly.
- The main power fuse often blows out, or the circuit breaker is often activated.
- A foreign matter or water fall inside the air conditioner.
- When the air conditioner does not operate even after the cause of the protective device activation has been removed. (The operation lamp and  on the remote controller are flashing.)
- Any other unusual conditions are observed.

Confirmation and check

When a trouble occurred in the air conditioner, the check code and the indoor unit No. appear on the display part of the remote controller.

The check code is only displayed during the operation.

If the display disappears, operate the air conditioner according to the following "Confirmation of error history" for confirmation.

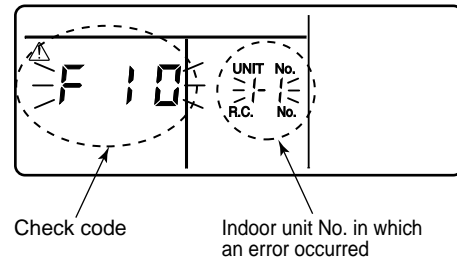

Confirmation of error history

When a trouble occurred on the air conditioner, the trouble history can be confirmed with the following procedure. (The trouble history is stored in memory up to 4 troubles.)

The history can be confirmed from both operating status and stop status.

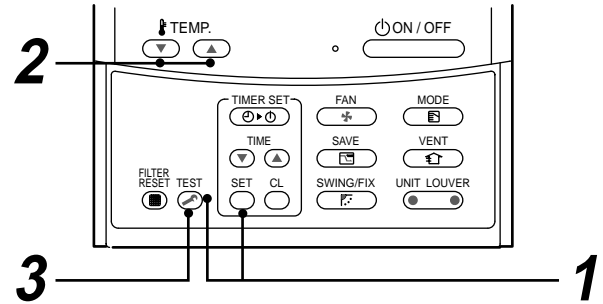

Procedure	Description
1	<p>When pushing and buttons at the same time for 4 seconds or more, the following display appears.</p> <p>If [Service check] is displayed, the mode enters in the trouble history mode.</p> <ul style="list-style-type: none"> • [01: Order of trouble history] is displayed in CODE No. window. • [Check code] is displayed. • [Indoor unit address in which an error occurred] is displayed in UNIT No.
2	<p>Every pushing of [/] button used to set temperature, the trouble history stored in memory is displayed in order. The numbers in CODE No. indicate CODE No. [01] (latest) → [04] (oldest).</p> <p>CAUTION</p> <p>Do not push button because all the trouble history of the indoor unit will be deleted.</p>
3	<p>After confirmation, push button to return to the usual display.</p>

1. Check the troubles according to the above procedure.
2. Ask an authorized dealer or qualified service (maintenance) professional to repair or maintain the air conditioner.
3. More details of the service code are explained in Service Manual.

Check these items. If any of these problems still remains, stop the operation, turn off the leakage breaker, and then notifies the dealer of the serial number and details of the error.









Never repair any part by yourself as it is dangerous.

When and a combination of *E*, *F*, *H*, *L* or *P* and a number are displayed on the remote controller, also inform the dealer of the display content.

4-12. Installation Manual

1 ACCESSORY PARTS

■ Accessory parts

Part name	Q'ty	Shape	Usage
Installation Manual	2	These manual	(Be sure to hand over to customers)
Heat insulating pipe	2		For heat insulation of pipe connecting section
Installation pattern	1	—	For confirmation of ceiling opening and indoor unit position
Installation gauge	—		For positioning of ceiling position
Washer	4		For hanging-down unit
Eccentric washer	4		For hanging-down unit
Hose band	1		For connecting drain pipe
Flexible hose	1		For adjusting center of drain pipe
Heat insulator	1		For heat insulation of drain connecting section
Heat insulator	1		For sealing of wire connecting port

■ Separate sold parts

- The Ceiling panel and remote controller are sold separately.
For the installation of these products, follow the Installation Manuals supplied with them.
- The wireless type remote controller is designed to be installed by attaching a wireless remote controller kit (sold separately) to the standard panel. (The wireless remote controller kit consists of a wireless remote controller and adjust corner caps with a receiver section.)

2 PRECAUTIONS FOR SAFETY

- Ensure that all Local, National and International regulations are satisfied.
- Read this "PRECAUTIONS FOR SAFETY" carefully before Installation.
- The precautions described below include the important items regarding safety. Observe them without fail.
- After the installation work, perform a trial operation (test run) to check for any problem.
Follow the Owner's Manual to explain how to use and maintain the unit to the customer.
- Turn off the main power supply switch (or breaker) before the unit maintenance.
- Ask the customer to keep the Installation Manual together with the Owner's Manual.

WARNING

- Ask an authorized dealer or qualified installation professional to install (including moving)/maintain the air conditioner.**
Inappropriate installation may result in water leakage, electric shock or fire.
- Be sure to connect earth wire. (grounding work)**
Incomplete grounding cause an electric shock.
Do not connect ground wires to gas pipes, water pipes, lightning rods or ground wires for telephone wires.
- Turn off the main power supply switch or breaker before attempting any electrical work.**
Make sure all power switches are off. Failure to do so may cause electric shock.
- Install the refrigerant pipe securely during the installation work before operating the air conditioner.**
If the air conditioner is operated with the valve open and without the refrigerant pipe, the compressor sucks air and the refrigeration cycle is overpressurized, which may cause a burst or injury.
- When moving the air conditioner for the installation into another place, be very careful not to enter any gaseous matter other than the specified refrigerant into the refrigeration cycle.**
If air or any other gas is mixed in the refrigerant, the gas pressure in the refrigeration cycle becomes abnormally high and it resultingly causes pipe burst and injuries on persons.
- Perform installation work properly according to the Installation Manual.**
Inappropriate installation may result in water leakage, electric shock or fire.
- When the air conditioner is installed in a small room, provide appropriate measures to ensure that the concentration of refrigerant leakage occur in the room does not exceed the critical level.**
- Install the air conditioner securely in a location where the base can sustain the weight adequately.**
- Perform the specified installation work to guard against an earthquake.**
If the air conditioner is not installed appropriately, accidents may occur due to the falling unit.
- If refrigerant gas has leaked during the installation work, ventilate the room immediately.**
If the leaked refrigerant gas comes in contact with fire, noxious gas may generate.
- After the installation work, confirm that refrigerant gas does not leak.**
If refrigerant gas leaks into the room and flows near a fire source, such as a cooking range, noxious gas might generate.
- Electrical work must be performed by a qualified electrician in accordance with the Installation Manual. Make sure the air conditioner uses an exclusive power supply.**
An insufficient power supply capacity or inappropriate installation may cause fire.
- Use the specified wires for wiring connect the terminals securely fix.**
To prevent external forces applied to the terminals from affecting the terminals.
- Conform to the regulations of the local electric company when wiring the power supply.**
Inappropriate grounding may cause electric shock.
- For the refrigerant recovery work (collection of refrigerant from the pipe to the compressor), stop the compressor before disconnecting the refrigerant pipe.**
If the refrigerant pipe is disconnected while the compressor is working with the valve open, the compressor sucks air and the refrigeration cycle is overpressurized, which may cause a burst or injury.

2 PRECAUTIONS FOR SAFETY

CAUTION

New Refrigerant Air Conditioner Installation

- **THIS AIR CONDITIONER ADOPTS THE NEW HFC REFRIGERANT (R410A) WHICH DOES NOT DESTROY OZONE LAYER.**
- The characteristics of R410A refrigerant are ; easy to absorb water, oxidizing membrane or oil, and its pressure is approx. 1.6 times higher than that of refrigerant R22.
Accompanied with the new refrigerant, refrigerating oil has also been changed.
Therefore, during installation work, be sure that water, dust, former refrigerant, or refrigerating oil does not enter the refrigerating cycle.
- To prevent charging an incorrect refrigerant and refrigerating oil, the sizes of connecting sections of charging port of the main unit and installation tools are changed from those for the conventional refrigerant.
- Accordingly the exclusive tools are required for the new refrigerant (R410A).
- For connecting pipes, use new and clean piping designed for R410A, and please care so that water or dust does not enter.

To Disconnect the Appliance from Main Power Supply.

- This appliance must be connected to the main power supply by means of a switch with a contact separation of at least 3 mm.
- **The installation fuse must be used for the power supply line of this conditioner.**
- **Tighten the flare nut with a torque wrench in the specified manner.**
Excessive tightening of the flare nut may cause a crack in the flare nut after a long period, which may result in refrigerant leakage.
- **Wear heavy gloves and a long sleeve shirt during the installation work to avoid injury.**

3 SELECTION OF INSTALLATION PLACE

WARNING

- **Install the air conditioner at enough strong place to withstand the weight of the unit.**
If the strength is not enough, the unit may fall down resulting in injury.
- **Install the air conditioner at a height 2.5m or more from the floor.**
If you insert your hands or others directly into the unit while the air conditioner operates, it is dangerous because you may contact with revolving fan or active electricity.

CAUTION

- **Do not install the air conditioner in a location subject to a risk of exposure to a combustible gas.**
If a combustible gas leaks and stays around the unit, a fire may occur.

Upon approval of the customer, install the air conditioner in a place that satisfies the following conditions.

- Place where the unit can be installed horizontally.
- Place where a sufficient servicing space can be ensured for safety maintenance and check.
- Place where drained water will not cause any problem.

Avoid installing in the following places.

- Place exposed to air with high salt content (seaside area), or place exposed to large quantities of sulfide gas (hot spring). (Should the unit be used in these places, special protective measures are needed.)
- A restaurant kitchen where a lot of oil is used or place near machines in a factory (Oil adhering to the heat exchanger and resin part (turbo fan) in the indoor unit may reduce the performance, generate mist or dew drop, or deform or damage resin parts.)
- Place where organic solvent is used nearby.
- Place close to a machine generating high frequency.
- Place where the discharged air blows directly into the window of the neighbor house. (Outdoor unit)
- Place where noise of the outdoor unit is easily transmitted.
(When install the outdoor unit on the boundary with the neighbor, pay due attention to the level of noise.)
- Place with poor ventilation. (Before air ducting work, check whether value of air volume, static pressure and duct resistance are correct.)
- Do not use the air conditioner for special purposes such as preserving food, precision instruments, or art objects, or where breeding animals or growing plants are kept.
(This may degrade the quality of preserved materials.)
- Place where any of high-frequency appliances (including inverter devices, private power generators, medical equipment, and communication equipment) and inverter-type fluorescent light is installed.
(A malfunction of the air conditioner, abnormal control, or problems due to noise to such appliances/ equipment may occur.)
- When the wireless remote controller is used in a room equipped with an inverter-type fluorescent light or at a place exposed to direct sunlight, signals from the remote controller may not be received correctly.
- Place where organic solvent is used.
- Place near a door or window exposed to humid outside air (Dew dropping may form.).
- Place where special spray is used frequently.

3 SELECTION OF INSTALLATION PLACE

■ Installation space

Secure the specified space in the figure for installation and servicing.

Model MMU-	A mm
AP0092H Type to AP0302H Type	271 or more
AP0362H Type to AP0562H Type	334 or more

◆ When incorporating fresh-air inlet box (sold separately)

Provide an inspection opening at the outside-air intake box side.

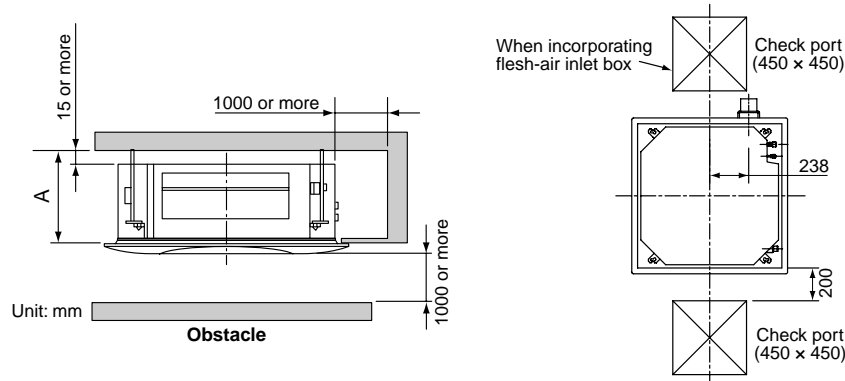

■ Selection of installation place

In case of continued operation of the indoor unit under high-humidity conditions as described below, dew may condense and water may drop.

Especially, high-humidity atmosphere (dew point temperature : 23°C or more) may generate dew inside the ceiling.

1. Unit is installed inside the ceiling with slated roof.
2. Unit is installed at a location using inside of the ceiling as fresh air take-in path.
3. Kitchen

Advice

- Set a service check opening panel at right side of the unit (size: 450 x 450mm or more) for piping, maintenance, and servicing.
- If installing a unit at such place, put insulating material (glass wool, etc.) additionally on all the positions of the indoor unit which come to contact with high-humidity atmosphere.

REQUIREMENT

When the humidity inside the ceiling seems to be higher than 80%, attach a heat insulator to the side (top) surface of the indoor unit. (Use a heat insulator that is 10mm or more thick.)

■ Ceiling height

When the height of the ceiling exceeds the distance of the item Standard/4-way in Table on the next page, the hot air is difficult to reach the floor.

Therefore, it is necessary to change the setup value of the high ceiling switch or discharge direction.

The high-ceiling setting is also necessary when installing separately sold filters.

REQUIREMENT

- When using the air conditioner with 2-way/3-way discharge system, a strong wind blows directly if the ceiling height is lower than the standard. Therefore, change the setting switch according to height of the ceiling.
- When using the high ceiling (1) or (3) with 4-way discharge system, the draft is apt to be felt due to drop of the discharge temperature.
- AP0092H Type and AP0122H Type air conditioners cannot be installed on a high ceiling.

◆ Height list of ceiling possible to be installed

(Unit: m)

Model MMU-	AP0092H to AP0122H			AP0152H to AP0182H			AP0242H to AP0302H			AP0362H to AP0562H			Setup of high ceiling
Discharge direction	4-way	3-way	2-way	4-way	3-way	2-way	4-way	3-way	2-way	4-way	3-way	2-way	SET DATA
Standard (At shipment)	2.7	2.8	3.0	2.8	3.2	3.5	3.0	3.3	3.6	3.9	4.2	4.5	0000
High ceiling (1)	—	—	—	3.2	3.5	3.8	3.3	3.5	3.8	4.2	4.4	4.6	0001
High ceiling (3)	—	—	—	3.5	3.8	—	3.6	3.8	—	4.5	4.6	—	0003

The lighting time of the filter sign (notification of filter cleaning) on the remote controller can be changed according to installation conditions.

When it is difficult to obtain satisfactory heating due to location place of the indoor unit or the structure of the room, the detection temperature of heating can be raised.

■ Discharge direction

As shown in the figure below, air discharge directions can be selected according to the shape of the room and the location of the indoor unit installation.

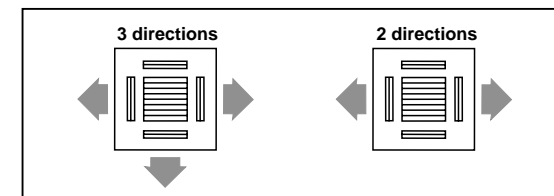

- Use a shielding plate kit (sold separately) to change discharge directions. Discharge directions are limited. Follow the Installation Manual supplied with the shielding plate kit.

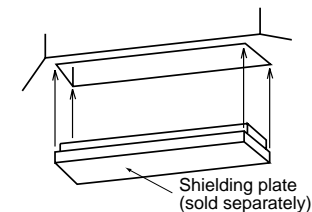

4 INSTALLATION

Installation of ceiling opening and hanging bolt

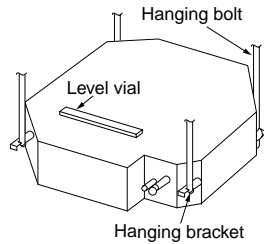

- Attach a nut (M10 or W3/8: not supplied) and the Ø34 washer (supplied) to each hanging bolt.
- Insert a washer on both sides of the T groove of the hanging bracket of the indoor unit, and hang the indoor unit.
- Check that the four sides of the indoor unit are level using a level vial (levelness: 5mm or less).
- Detach the installation gauge (accessory) from the installation pattern.
- Using the installation gauge, check and adjust the positional relation between the indoor unit and the ceiling opening (1) (10 to 35mm: 4 sides) and the hanging-up height (2) (mm: 4 corners). (How to use the installation gauge is printed on the gauge.)

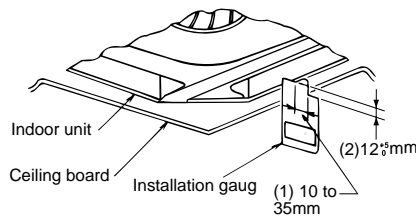
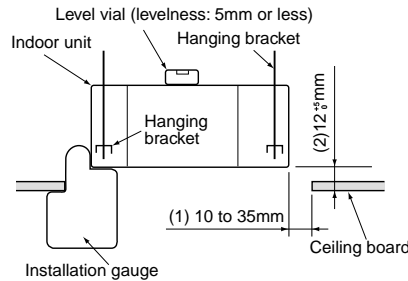
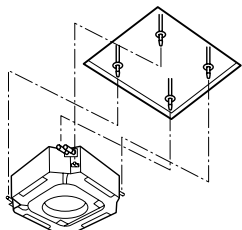
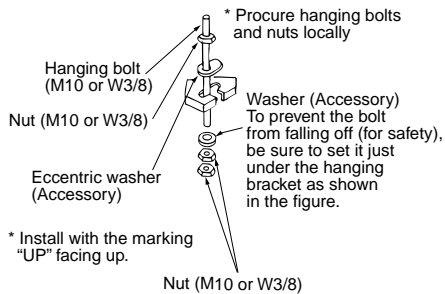

REQUIREMENT

Before installation of the indoor unit, be sure to remove the cushion for transportation between the fan and the bell mouth. Running the unit without removing the cushion may damage the fan motor.

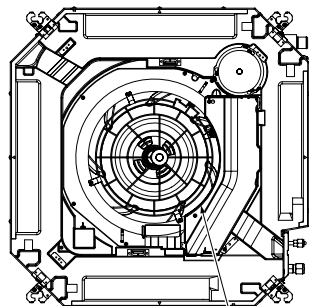

Be sure to remove the cushion for transportation between the fan and the bell mouth.

Installation of ceiling panel (Sold separately)

Install the ceiling panel according to Installation Manual attached with it after piping/wiring work has completed.

Check that installation of indoor unit and ceiling opening part is correct, and then install it.

REQUIREMENT

- Joint the connecting sections of ceiling panel, ceiling surface, ceiling panel and indoor unit closely. Any gap between them will cause air leakage and generate condensation or water leakage.
- Remove the adjust corner caps at the four corners of the ceiling panel, and then install the ceiling panel onto the indoor unit.
- Make sure that the claws of the four adjust corner caps are securely fit.
 - * Improper fitting of the claws may cause water leakage.

In case of wireless type

The sensor of indoor unit with wireless remote controller can receive a signal by distance within approx. 7m.

Based upon it, determine a place where the remote controller is operated and the installation place.

- Operate the remote controller, confirm that the indoor unit receives a signal surely, and then install it.
- Keep 1m or more from the devices such as television, stereo, etc. (Disturbance of image or noise may generate.)
- To prevent a malfunction, select a place where is not influenced by a fluorescent light or direct sunlight.
- Two or more (Up to 6 units) indoor units with wireless type remote controller can be installed in the same room.

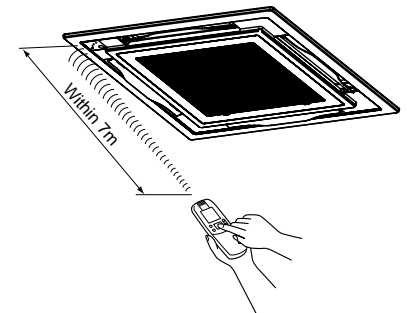

Installation of remote controller (Sold separately)

For installation of the wired remote controller, follow the Installation Manual attached with the remote controller.

- Pull out the remote controller cord together with the refrigerant pipe or drain pipe. Be sure to pass the remote controller cord through upper side of the refrigerant pipe and drain pipe.
- Do not leave the remote controller at a place exposed to the direct sunlight and near a stove.

5 DRAIN PIPING WORK

CAUTION

- Following the Installation Manual, perform the drain piping work so that water is properly drained, and apply a heat insulation so as not to cause a dew dropping.

Inappropriate piping work may result in water leakage in the room and wet of furniture.

Piping/Heat insulating material

Require the following materials for piping and heat insulating at site.

Piping	Hard vinyl chloride pipe VP25 (Outer dia. : Ø32mm)
Heat insulator	Foam polyethylene : Thickness 10mm or more

Flexible hose

Use the attached flexible hose to adjust center discrepancy of the hard vinyl chloride pipe or to adjust the angle.

- Do not use the flexible hose as stretched, or do not deform it more extent than that in the following figure.
- Be sure to fix the soft end of the flexible hose with the attached hose band.
- Use the flexible hose on a horizontal level.

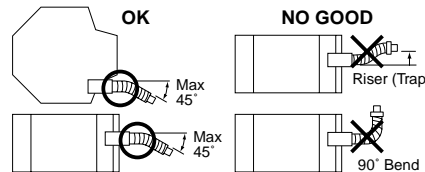

REQUIREMENT

- Be sure to perform heat insulation of the drain pipes of the indoor unit.
- Never forget to perform heat insulation of the connecting part with the indoor unit. An incomplete heat insulation causes dew dropping.
- Set the drain pipe with downward slope (1/100 or more), and do not make swelling or trap on the piping. It may cause an abnormal sound.

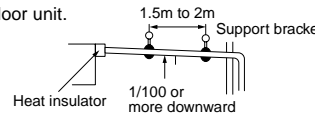

- For length of the traversing drain pipe, restrict to 20m or less. In case of a long pipe, provide support brackets with interval of 1.5 to 2m in order to prevent waving.

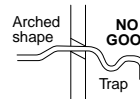

- Set the collective piping as shown in the below figure.

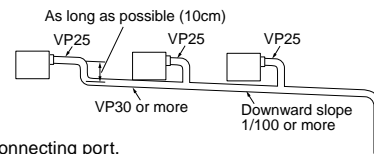

- Be sure not to apply force to the connecting part of the drain pipe.
- The hard vinyl-chloride pipe cannot be directly connected to the drain pipe connecting part of the indoor unit.

For connection with the drain pipe connecting port, be sure to use/fix the attached flexible hose with the hose band, otherwise a damage or water leak is caused on the drain pipe connecting port.

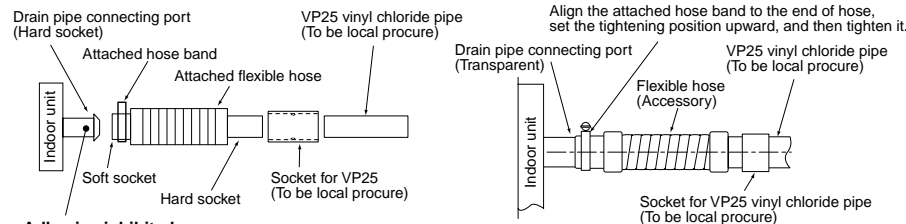

Adhesive inhibited :

Use the attached flexible hose and hose band for connecting the drain hose to the clear drain socket. If applying the adhesive, socket will be damaged and cause water leakage.

Connecting drain pipe

- Connect a hard socket (procured locally) to the hard socket of the attached supplied flexible hose.
- Connect a drain pipe (procured locally) to the connected hard socket.

REQUIREMENT

- Connect hard vinyl chloride pipes securely using an adhesive for vinyl chloride to avoid water leakage.
- It takes some time until the adhesive is dried and hardened (refer to the manual of the adhesive).

Do not apply stress to the joint with the drain pipe during this time period.

Drain up

When a down-gradient cannot be secured for the drainpipe, drain-up piping is possible.

- The height of the drain pipe must be 850 mm or less from the bottom of the ceiling.
- Take the drain pipe out of the drain pipe joint with the indoor unit in 300 mm or less, and bend up the pipe vertically.
- Immediately after the pipe is bent up vertically, lay the pipe making a down-gradient.
- Set downward grading immediately after raising up vertically.

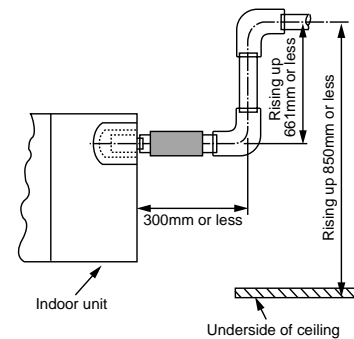

Check the draining

In the test run, check that water drain is properly performed and water does not leak from the connecting part of the pipes.

Be sure to check draining also when installed in heating period.

Using a pitcher or hose, pour water (1500 to 2000cc) into the discharge port before installation of the ceiling panel.

Pour water gradually so that water does not spread on the motor of the drain pump.

CAUTION

Pour water gently so that it does not spread around inside the indoor unit, which may cause a malfunction.

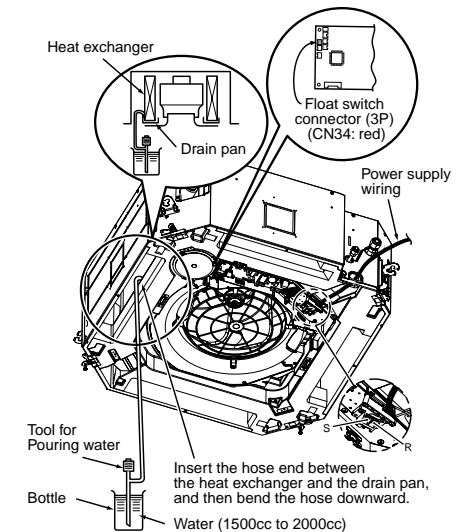

- After the electric work has finished, pour water during COOL mode operation.
- If the electric work has not yet finished, pull out the float switch connector (CN34 : Red) from the electric parts box, and check draining by plugging the single phase 220-240V power to the terminal blocks R(L) and S(N).

If doing so, the drain pump motor operates. (Never apply 220-240 V to Ⓧ, Ⓧ, ⓐ or ⓑ, otherwise a trouble of P.C. board occurs.)

5 DRAIN PIPING WORK

- Test water drain while checking the operation sound of the drain pump motor.
(If the operation sound changes from continuous sound to intermittent sound, water is normally drained.)

After the check, the drain pump motor runs, connecting the float switch connector.
(In case of check by pulling out the float switch connector, be sure to return the connector to the original position.)

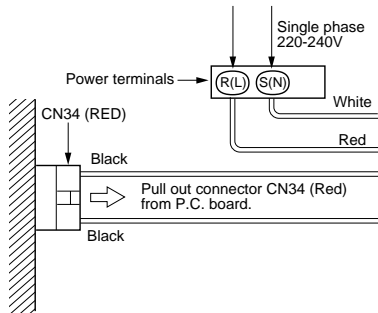

■ Perform heat insulating

- As shown in the figure, cover the flexible hose and hose band with the attached heat insulator up to the bottom of the indoor unit without gap.
- Cover the drain pipe seamlessly with a heat insulator to be procured locally so that it overlaps with the attached heat insulator of the drain connecting section.

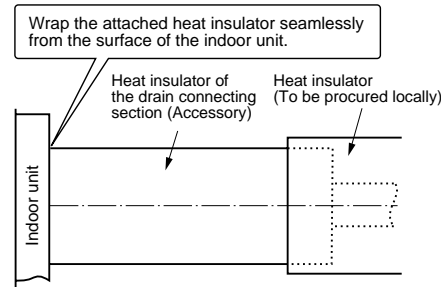

* Direct the slits and seams of the heat insulator upward to avoid water leakage.

6 REFRIGERANT PIPING AND EVACUATING

■ Refrigerant Piping

1. Use copper pipe with 0.8 mm or more thickness. (In case pipe size is $\varnothing 15.9$, with 1.0mm or more.)
2. Flare nut and flare works are also different from those of the conventional refrigerant.
Take out the flare nut attached to the main unit of the air conditioner, and use it.

REQUIREMENT

When the refrigerant pipe is long, provide support brackets at intervals of 2.5 to 3m to clamp the refrigerant pipe.

Otherwise, abnormal sound may be generated.

⚠ CAUTION

IMPORTANT 4 POINTS FOR PIPING WORK

1. Remove dust and moisture from the inside of the connecting pipes.
2. Tight connection (between pipes and unit)
3. Evacuate the air in the connecting pipes using VACUUM PUMP.
4. Check the gas leakage. (Connected points)

■ Pipe size

Model MMU-		AP0092H to AP0122H	AP0152H to AP0182H	AP0242H to AP0562H
Pipe size (Dia. : mm)	Gas side	9.5	12.7	15.9
	Liquid side	6.4	6.4	9.5

■ Permissible Piping Length and Height Difference

They vary according to the outdoor unit.
For details, refer to the Installation Manual attached to the outdoor unit.

Flaring

- Cut the pipe with a pipe cutter.
Remove burrs completely.
Remaining burrs may cause gas leakage.
- Insert a flare nut into the pipe, and flare the pipe.
As the flaring sizes of R410A differ from those of refrigerant R22, the flare tools newly manufactured for R410A are recommended.
However, the conventional tools can be used by adjusting projection margin of the copper pipe.

- ◆ Projection margin in flaring : B (Unit : mm)
Rigid (Clutch type)

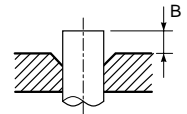

Outer dia. of copper pipe	R410A tool used	Conventional tool used
	R410A	R410A
6.4, 9.5	0 to 0.5	1.0 to 1.5
12.7, 15.9		

- ◆ Flaring dia. meter size : A (Unit : mm)

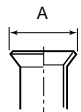

Outer dia. of copper pipe	A ⁺¹ _{-0.4}
	R410A
6.4	9.1
9.5	13.2
12.7	16.6
15.9	19.7

* In case of flaring for R410A with the conventional flare tool, pull it out approx. 0.5 mm more than that for R22 to adjust to the specified flare size.
The copper pipe gauge is useful for adjusting projection margin size.

6 REFRIGERANT PIPING AND EVACUATING

Tightening connection

⚠ CAUTION

- Do not apply excessive torque. Otherwise, the nut may crack depending on the conditions.

(Unit : N•m)

Outer dia. of copper pipe	Tightening torque
6.4 mm (dia.)	14 to 18 (1.4 to 1.8 kgf•m)
9.5 mm (dia.)	33 to 42 (3.3 to 4.2 kgf•m)
12.7 mm (dia.)	50 to 62 (5.0 to 6.2 kgf•m)
15.9 mm (dia.)	68 to 82 (6.8 to 8.2 kgf•m)

◆ Tightening torque of flare pipe connections

Pressure of R410A is higher than that of R22. (Approx. 1.6 times) Therefore, using a torque wrench, tighten the flare pipe connecting sections which connect the indoor and outdoor units of the specified tightening torque.

Incorrect connections may cause not only a gas leak, but also a trouble of the refrigeration cycle.

Align the centers of the connecting pipes and tighten the flare nut as far as possible with your fingers. Then tighten the nut with a spanner and torque wrench as shown in the figure.

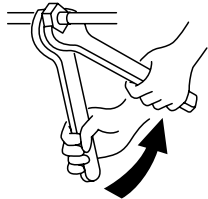

Work using double spanner

REQUIREMENT

Tightening with an excessive torque may crack the nut depending on installation conditions.

Tighten the nut within the specified tightening torque.

Piping with outdoor unit

- Shape of valve differs according to the outdoor unit. For details of installation, refer to the Installation Manual of the outdoor unit.

■ Airtight test/Air purge, etc.

For airtight test, air purge, addition of refrigerant, and gas leak check, refer to the Installation Manual attached to the outdoor unit.

REQUIREMENT

Do not supply power to the indoor unit until the airtight test and vacuuming are completed. (If the indoor unit is powered on, the pulse motor valve is fully closed, which extends the time for vacuuming.)

Open the valve fully

Open the valve of the outdoor unit fully.

For details, refer to the Installation Manual attached to the outdoor unit.

Thermal insulation process

Apply thermal insulation for the pipes separately at liquid side and gas side.

For the thermal insulation to the pipes at gas side, be sure to use the material with heat-resisting temperature 120°C or higher.

Using the attached thermal insulation material, apply the thermal insulation to the pipe connecting section of the indoor unit securely without gap.

REQUIREMENT

- Apply the thermal insulation to the pipe connecting section of the indoor unit securely up to the root without exposure of the pipe. (The pipe exposed to the outside causes water leak.)
- Wrap heat insulator with its slits facing up (ceiling side).

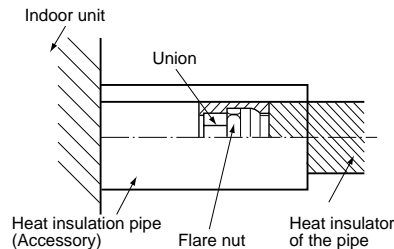

7 ELECTRICAL WORK

⚠ WARNING

- Using the specified wires, ensure to connect the wires, and fix wires securely so that the external tension to the wires do not affect the connecting part of the terminals.

Incomplete connection or fixation may cause a fire, etc.

- Be sure to connect earth wire. (grounding work)

Incomplete grounding cause an electric shock.

Do not connect ground wires to gas pipes, water pipes, lightning rods or ground wires for telephone wires.

- Appliance shall be installed in accordance with national wiring regulations.

Capacity shortage of power circuit or incomplete installation may cause an electric shock or a fire.

⚠ CAUTION

- If incorrect/incomplete wiring is carried out, it will cause an electrical fire or smoke.
- Be sure to install an earth leakage breaker that is not tripped by shock waves. If an earth leakage breaker is not installed, an electric shock may be caused.
- Be sure to use the cord clamps attached to the product.
- Do not damage or scratch the conductive core and inner insulator of power and inter-connecting wires when peeling them.
- Use the power cord and Inter-connecting wire of specified thickness, type, and protective devices required.
- Never connect 220–240V power to the terminal blocks (Ⓜ, Ⓝ, Ⓐ, Ⓑ, etc.) for control wiring. (Otherwise, the system will fail.)

REQUIREMENT

- For power supply wiring, strictly conform to the Local Regulation in each country.
- For wiring of power supply of the outdoor units, follow the Installation Manual of each outdoor unit.
- Perform the electric wiring so that it does not come to contact with the high-temperature part of the pipe. The coating may melt resulting in an accident.
- After connecting wires to the terminal blocks, provide a trap and fix wires with the cord clamp.
- Run the refrigerant piping line and control wiring line in the same line.
- Do not turn on the power of the indoor unit until vacuuming of the refrigerant pipes completes.

■ Power supply wire and communication wires specifications

Power supply wire and communication wires are procured locally.

For the power supply specifications, follow to the table below.

If capacity is little, it is dangerous because over-heat or seizure may be caused.

For specifications of the power capacity of the outdoor unit and the power supply wires, refer to the Installation Manual attached to the outdoor unit.

Indoor unit power supply

- For the power supply of the indoor unit, prepare the exclusive power supply separated from that of the outdoor unit.
- Arrange the power supply, earth leakage breaker, and main switch of the indoor unit connected to the same outdoor unit so that they are commonly used.
- Power supply wire specification : Cable 3-core 2.5mm², in conformity with Design 60245 IEC 57.

◆ Power supply

Power supply	220–240V ~, 50Hz 220V ~, 60Hz
Power supply switch/Earth leakage breaker or power supply wiring/fuse rating for indoor units should be selected by the accumulated total current values of the indoor units.	
Power supply wiring	Below 50m 2.5 mm ²

Control wiring, Central controller wiring

- 2-core with polarity wires are used for the Control wiring between indoor unit and outdoor unit and Central controller wiring.
- To prevent noise trouble, use 2-core shield wire.
- The length of the communication line means the total length of the inter-unit wire length between indoor and outdoor units added with the central control system wire length.

7 ELECTRICAL WORK

◆ Communication line

Control wiring between indoor units, and outdoor unit (2-core shield wire)	Wire size	(Up to 1000m) 1.25 mm ² (Up to 2000m) 2.0 mm ²
Central control line wiring (2-core shield wire)	Wire size	(Up to 1000m) 1.25 mm ² (Up to 2000m) 2.0 mm ²

Remote controller wiring

- 2-core with non-polarity wire is used for wiring of the remote controller wiring and group remote controllers wiring.

Remote controller wiring, remote controller inter-unit wiring	Wire size: 0.5mm ² to 2.0mm ²
---	---

Total wire length of remote controller wiring and remote controller inter-unit wiring = L + L1 + L2 + ... Ln	In case of wired type only	Up to 500m
	In case of wireless type included	Up to 400m
Total wire length of remote controller inter-unit wiring = L1 + L2 + ... Ln		Up to 200m

⚠ CAUTION

The remote controller wire (Communication line) and AC220–240V wires cannot be parallel to contact each other and cannot be stored in the same conduits.

If doing so, a trouble may be caused on the control system due to noise, etc.

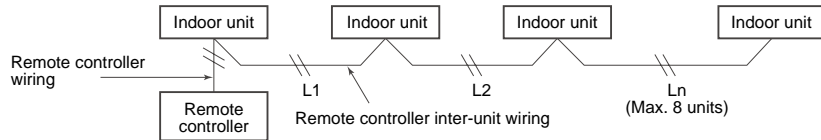

■ Wire connection

REQUIREMENT

- Be sure to connect the wires matching the terminal numbers. Incorrect connection causes a trouble.
- Be sure to pass the wires through the bushing of wiring connection port of the indoor unit.
- Keep a margin (Approx. 100mm) on a wire to hang down the electric parts box at servicing, etc.
- The low-voltage circuit is provided for the remote controller. (Do not connect the high-voltage circuit)
- Make a loop on the wire for margin of the length so that the electric parts box can be taken out during servicing.

- Remove the cover of the electric parts box by taking off the mounting screws (2 positions) and pushing the hooking section. (The cover of the electric parts box remains hanged to the hinge.)
- Connect the power supply wire and remote controller wire to the terminal block of the electric parts box.
- Tighten the screws of the terminal block, and fix the wires with cord clamp attached to the electric parts box. (Do not apply tension to the connecting section of the terminal block.)
- Using the attached thermal insulation material, seal the pipe connecting port. Otherwise, dewing may be caused.
- Mount the cover of the electric parts box without pinching wires. (Mount the cover after wiring on the ceiling panel.)

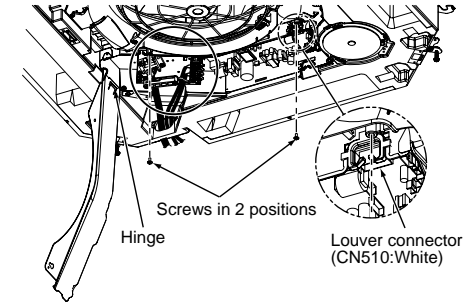
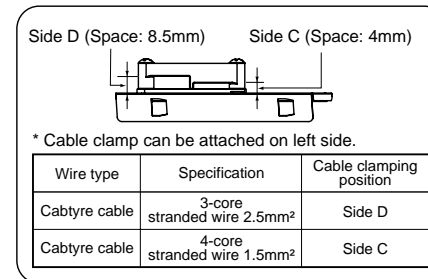

◆ Thermal insulation to wiring connecting port

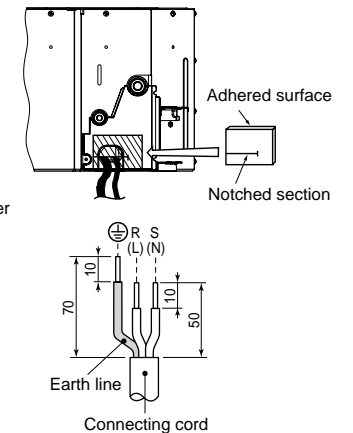
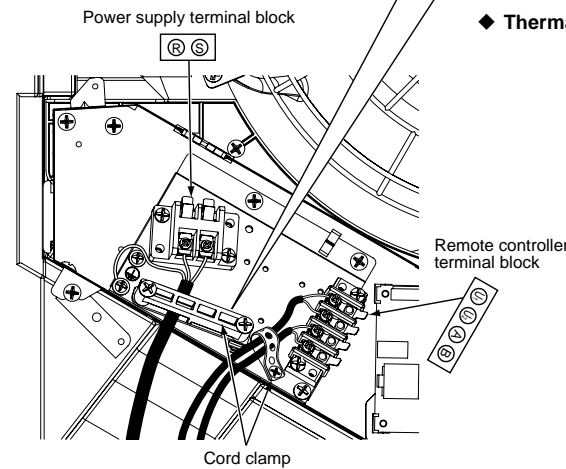

7 ELECTRICAL WORK

Remote controller wiring

- As the remote controller wire has non-polarity, there is no problem if connections to indoor unit terminal blocks A and B are reversed.

Wiring diagram

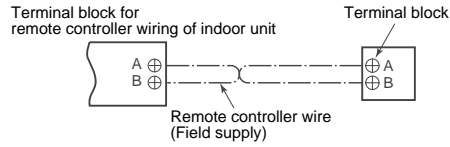

Wiring between indoor and outdoor units

NOTE

An outdoor unit connected with control wiring between indoor and outdoor units wire becomes automatically the header unit.

Wiring example

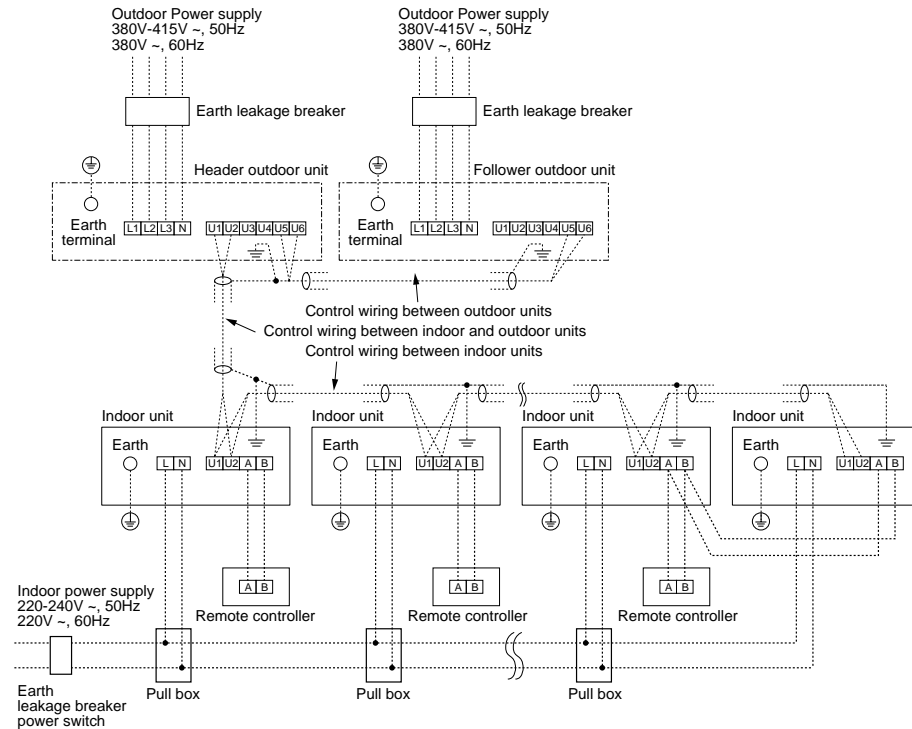

Wiring for flow selector unit (sold separately)

Connect control wiring and power supply following figure when installing a separately sold cooling/heating switching unit.

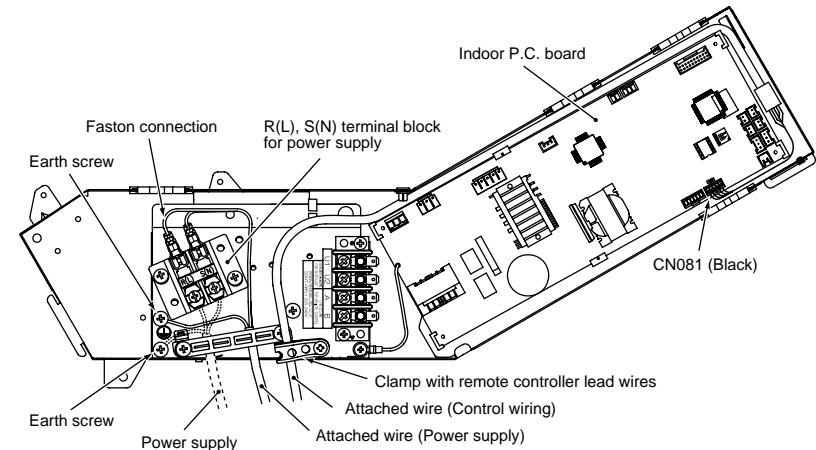

Address setup

Set up the addresses as per the Installation Manual supplied with the outdoor unit.

Wiring on the ceiling panel

According to the Installation Manual of the ceiling panel, connect the connector (20P: White) of the ceiling panel to the connector (CN510: White) on P.C. board of the electric parts box.

8 APPLICABLE CONTROLS

REQUIREMENT

- When you use this air conditioner for the first time, it takes approx. 5 minutes until the remote controller becomes available after power-on. This is normal.

<When power is turned on for the first time after installation>

It takes **approx. 5 minutes** until the remote controller becomes available.

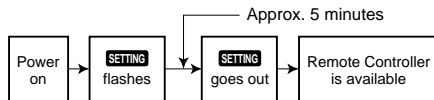

<When power is turned on for the second (or later) time>

It takes **approx. 1 minute** until the remote controller becomes available.

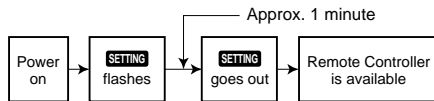

- Normal settings were made when the indoor unit was shipped from factory. Change the indoor unit settings as required.
- Use the wired remote controller to change the settings.
 - * The settings cannot be changed using the wireless remote controller, sub remote controller, or remote-controllerless system (for central remote controller only). Therefore, install the wired remote controller to change the settings.

■ Changing of settings of for applicable controls

Basic procedure for changing settings

Change the settings while the air conditioner is not working. (Be sure to stop the air conditioner before making settings.)

The display content for setting differs from that on the former types of remote controller (RBCAMT21E/AMT31E). (The number of CODE NO. has increased.)

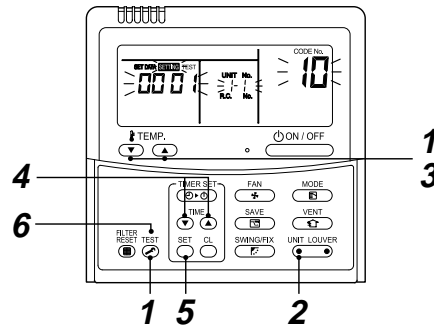

Procedure 1

Push **TEST** button and “TEMP.” button simultaneously for at least 4 seconds.

After a while, the display flashes as shown in the figure. Confirm that the CODE No. is [10].

- If the CODE No. is not [10], push **TEST** button to erase the display content, and repeat the procedure from the beginning. (No operation of the remote controller is accepted for a while after **TEST** button is pushed.) (While air conditioners are operated under the group control, “ALL” is displayed first. When **UNIT LOUVER** is pushed, the indoor unit number displayed following “ALL” is the header unit.)

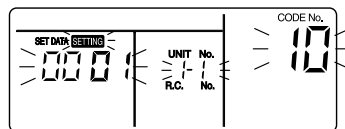

(* Display content varies with the indoor unit model.)

Procedure 2

Each time you push **UNIT LOUVER** button, indoor unit numbers in the control group change cyclically.

Select the indoor unit you want to change settings for. The fan of the selected unit runs and the louvers start swinging. You can confirm the indoor unit for which you want to change settings.

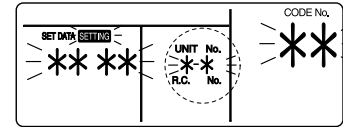

Procedure 3

Using “TEMP.” button, specify CODE No. [**].

Procedure 4

Using timer “TIME” button, select SET DATA [***].

Procedure 5

Push **SET** button. When the display changes from flashing to lit, the setup is completed.

- To change settings of another indoor unit, repeat from **Procedure 2**.
- To change other settings of the selected indoor unit, repeat from **Procedure 3**. Use **SET** button to clear the settings. To make settings after **SET** button was pushed, repeat from **Procedure 2**.

Procedure 6

When settings have been completed, push **TEST** button to determine the settings.

When **TEST** button is pushed, **SETTING** flashes and then the display content disappears and the air conditioner enters the normal stop mode. (While **SETTING** is flashing, no operation of the remote controller is accepted.)

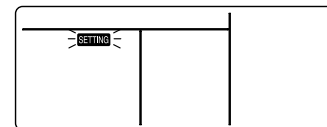

■ When installing separately sold filters

Be sure to make ceiling setting when installing separately sold filters.

- * Separately sold filters cannot be installed in an indoor unit on a high ceiling.

Follow to the basic operation procedure (1 → 2 → 3 → 4 → 5 → 6).

- For the CODE No. in **Procedure 3**, specify [5d].
- For the set data in **Procedure 4**, select the SET DATA of filters to be installed from the following table.

SET DATA	High-ceiling setting
0000	Normal filter (Factory setting)

SET DATA	High-ceiling setting
0003	High Efficiency Filter (65%) High Efficiency Filter (90%)

■ Installing indoor unit on high ceiling

When an indoor unit is installed on a ceiling higher than the standard height, make the high-ceiling setting for air volume adjustment.

- Take the same procedure as that in “When installing separately sold filters”.
- For the set data in **Procedure 3**, specify [5d].
- Select the SET DATA for **Procedure 4** from the “Height list of ceiling possible to be installed” table on page 35 in this manual.

8 APPLICABLE CONTROLS

■ When wireless remote controller is used

Change the high-ceiling and filter settings with the DIP switch on the receiver section P.C. board. For details, refer to the manual of the wireless remote controller kit.

The settings can also be changed with the switch on the indoor microcomputer P.C. board.

* Once the setting is changed, setting to **0001** or **0003** is possible, however setting to **0000** requires a setting data change to **0000** using the wired remote controller (separately sold) with the normal switch setting (factory setting).

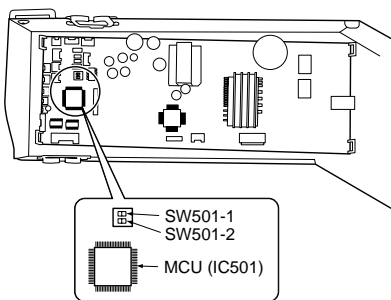

SET DATA	SW501-1	SW501-2
0000 (Factory setting)	OFF	OFF
0001	ON	OFF
0003	OFF	ON

To restore the factory settings

To return the DIP switch settings to the factory settings, set SW501-1 and SW501-2 to OFF, connect a separately sold wired remote controller, and then set the data of CODE No. [5d] to "0000" in "When installing separately sold filters" on this page.

SET DATA	Filter sign lighting time
0000	None
0001	150H
0002	2500H (Factory setting)
0003	5000H
0004	10000H

■ Change of lighting time of filter sign

According to the installation condition, the lighting time of the filter sign (Notification of filter cleaning) can be changed. Follow the basic operation procedure (1 → 2 → 3 → 4 → 5 → 6).

- For the CODE No. in **Procedure 3**, specify [01].
- For the SET DATA in **Procedure 4**, select the SET DATA of filter sign lighting time from the following table.

■ To secure better effect of eating

When it is difficult to obtain satisfactory heating up to installation place of the indoor unit or structure of the room, the detection temperature of eating can be raised.

Also use a circulator, etc. to circulate heat air near the ceiling. Follow the basic operation procedure (1 → 2 → 3 → 4 → 5 → 6).

- For the CODE No. in **Procedure 3**, specify [06].
- For the set data in **Procedure 4**, select the SET DATA of shift value of detection temperature to be set up from the table below.

SET DATA	Detection temp shift value
0000	No shift
0001	+1°C
0002	+2°C (Factory setting)
0003	+3°C
0004	+4°C
0005	+5°C
0006	+6°C

■ To select horizontal wind direction

1. Push **TEST** and "TEMP. (▼)" buttons for at least four seconds when the air conditioner is not working. **SETTING** flashes. Indicates CODE No. [01].
2. Select an indoor unit to be set by pushing **UNIT LOUVER** button (left side of the button). Indoor unit number changes each time you push the button.

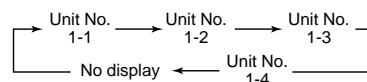

The fan of the selected unit runs and the louvers start swinging.

3. Change the CODE No. to [45] with "TEMP. (▼) / (▲)" buttons.
4. Select wind direction setting with "TIME (▼) / (▲)" buttons.

Wind direction SET DA	Wind direction setting
0000	Smudge reducing position (Air direction to reduce ceiling contamination) [Factory setting]
0002	Cold draft position (Air direction to control cold air fall)

5. Push **SET** button to check the setting. The display state changes from flashing to lighting, and the setting is fixed.
6. Push **TEST** button to end the setting.
 - * When the cold draft position is selected, ceiling contamination is less reduced.

■ How to set up swing type

1. Push **SWING/FIX** for at least four seconds when the air conditioner is not working. **SETTING** flashes. Indicates CODE No. [F0].
2. Select an indoor unit to be set by pushing **UNIT LOUVER** (left side of the button). Each time you push the button, unit numbers change as follows:

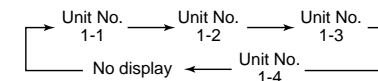

The fan of the selected unit runs and the louvers start swinging.

3. Select a swing type by pushing "TIME (▼) / (▲)" buttons.

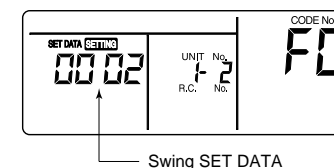

Swing SET DATA	Swing of louvers
0001	Standard swing (Factory setting)
0002	Dual swing
0003	Cycle swing

⚠ CAUTION

Do not set the swing SET DATA to "0000". (This setting may cause a failure of the louvers.)

8 APPLICABLE CONTROLS

• About “Dual swing”

“Dual” means that louvers **01** and **03** are directed and swing in one direction and louvers **02** and **04** are directed and swing in the opposite direction.
(When louvers **01** and **03** are directed downward, louvers **02** and **04** are directed horizontally.)

• About “Cycle swing”

The four louvers swing independently at respective timings.

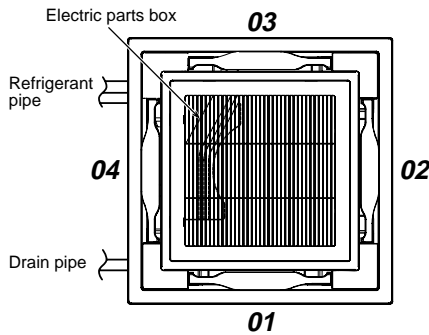

4. Push **SET** button.
5. Push **TEST** button to complete the setting.

■ How to set up louver lock (No swing)

1. Push **UNIT LOUVER** (right side of the button) for at least four seconds when the air conditioner is not working. **SETTING** flashes.
Indicates CODE No. [F1].
2. Select an indoor unit to be set by pushing XX (left side of the button).
Each time you push the button, unit numbers change as follows: The fan of the selected unit runs and the louvers start swinging.

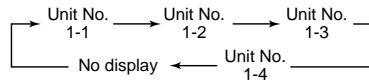

3. Select a louver you want to lock by pushing “TEMP. **▽** / **△**” buttons.
4. Select the wind direction of the louver you do not want to swing by pushing “TIME **▽** / **△**” buttons.

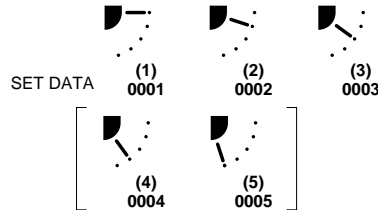

* When (4) or (5) is selected, dew drop may occur during cooling mode.

5. Determine the setting by pushing **SET** button.
When the setting has been determined, **+** lights up.
6. Push **TEST** button to complete the setting.

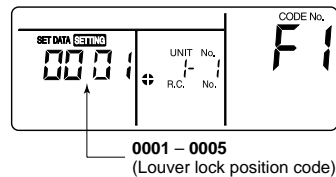

■ How to cancel louver lock

Set the wind direction to “0000” of the louver lock setup procedure above.



- When the setting is canceled, **+** goes out.
Other operations are the same as those in “How to set up louver lock (No swing)”.

■ Group control

In a group control, a remote controller can control up to maximum 8 units.

- For wiring procedure and wiring method of the individual line (Identical refrigerant line) system, refer to “Electric work” in this Manual.
- Wiring between indoor units in a group is performed in the following procedure.
Connect the indoor units by connecting the remote controller inter-unit wires from the remote controller terminal blocks (A/B) of the indoor unit connected with a remote controller to the remote controller terminal blocks (A/B) of the other indoor unit. (Non-polarity)
- For address setup, refer to the Installation Manual attached to the outdoor unit.

■ Remote controller sensor

The temperature sensor of the indoor unit senses room temperature usually.

Set the remote controller sensor to sense the temperature around the remote controller.

Select items following the basic operation procedure (1 → 2 → 3 → 4 → 5 → 6).

- Specify [32] for the CODE NO. in **Procedure 3**.
- Select the following data for the SET DATA in **Procedure 4**.

SET DATA	0000	0001
Remote controller sensor	Not used (factory setting)	Used

When **+** flashes, the remote controller sensor is defective.

Select the SET DATA [0000] (not used) or replace the remote controller.

9 TEST RUN

■ Before test run

- Before turning on the power supply, carry out the following procedure.
 - 1) Using 500V-megger, check that resistance of 1MΩ or more exists between the terminal block of the power supply and the earth (grounding).
If resistance of less than 1MΩ is detected, do not run the unit.
 - 2) Check the valve of the outdoor unit being opened fully.
- To protect the compressor at activation time, leave power-ON for 12 hours or more before operating.
- Never press the electromagnetic contactor to forcibly perform a test run. (This is very dangerous because the protective device does not work.)
- Before starting a test run, be sure to set addresses following the installation manual supplied with the outdoor unit.

■ How to execute a test run

Using the remote controller, operate the unit as usual.
For the procedure of the operation, refer to the attached Owner's Manual.
A forced test run can be executed in the following procedure even if the operation stops by thermo.-OFF.
In order to prevent a serial operation, the forced test run is released after 60 minutes have passed and returns to the usual operation.



- Do not use the forced test run for cases other than the test run because it applies an excessive load to the devices.

In case of wired remote controller

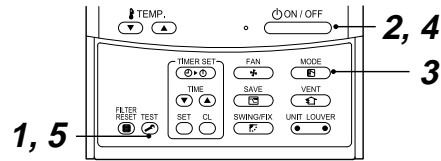

Procedure 1

Keep **TEST** button pushed for 4 seconds or more.
[TEST] is displayed on the display part and the selection of mode in the test mode is permitted.

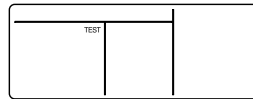

Procedure 2

Push **ON/OFF** button.

Procedure 3

Using **MODE** button, select the operation mode, [* COOL] or [* HEAT].

- Do not run the air conditioner in a mode other than [* COOL] or [* HEAT].
- The temperature controlling function does not work during test run.
- The detection of error is performed as usual.

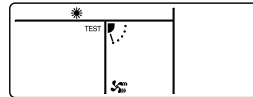

Procedure 4

After the test run, push **ON/OFF** button to stop a test run. (Display part is same as **Procedure 1**.)

Procedure 5

Push **TEST** check button to cancel (release from) the test run mode. ([TEST] disappears on the display and the status returns to a normal.)

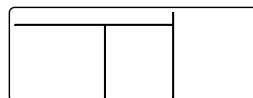

In case of wireless remote controller

Procedure 1

Turn on the power of the air conditioner.

When power is turned on for the first time after installation, it takes approx. 5 minutes until the remote controller becomes available.

In the case of subsequent power-on, it takes approx. 1 minute until the remote controller becomes available. Execute a test run after the predetermined time has passed.

Procedure 2

Push "ON/OFF" button on the remote controller, select [* COOL] or [* HEAT] with "MODE" button, and then select [* HIGH] with "FAN" button.

Procedure 3

Cooling test run	Heating test run
Set the temperature to 18°C with the temp. setup buttons.	Set the temperature to 30°C with the temp. setup buttons.

Procedure 4

Cooling test run	Heating test run
After confirming a signal receiving sound "beep" immediately set the temperature to 19°C with the temp. setup buttons.	After confirming a signal receiving sound "beep" immediately set the temperature to 29°C with the temp. setup buttons.

Procedure 5

Cooling test run	Heating test run
After confirming a signal receiving sound "beep" immediately set the temperature to 18°C with the temp. setup buttons.	After confirming a signal receiving sound "beep" immediately set the temperature to 30°C with the temp. setup buttons.

Procedure 6

Repeat procedures 4 → 5 → 4 → 5.

Indicators "Operation" (green), "Timer" (green), and "Ready" (orange) in the wireless receiver section flash in approx. 10 seconds, and the air conditioner starts operation.

If any of these indicators does not flash, repeat **Procedures 3 to 5**.

Procedure 7

Upon completion of the test run, push "ON/OFF" button to stop operation.

<Overview of test run operations using the wireless remote controller>

◆ Cooling test run:

ON/OFF → 18°C → 19°C → 18°C → 19°C → 18°C → 19°C → (test run) → ON/OFF

◆ Heating test run:

ON/OFF → 30°C → 29°C → 30°C → 29°C → 30°C → (test run) → ON/OFF

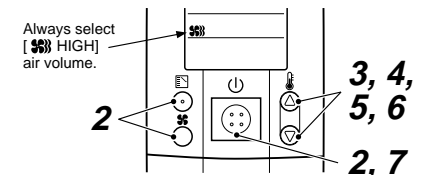

10 MAINTENANCE

CAUTION

Before maintenance, be sure to turn off the leakage breaker.

Cleaning of air filter

- If  is displayed on the remote controller, maintain the air filter.
- Clogging of the air filter reduce cooling/heating performance.

Cleaning of panel and air filter

Preparation :

1. Turn off the air conditioner by the remote controller.
2. Open the suction grille.
 - Slide the button of the suction grille inward, and open the suction grille slowly while holding it.

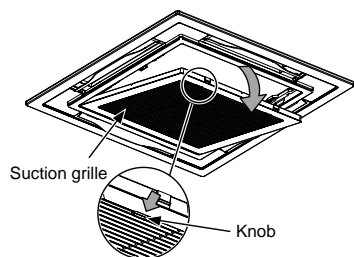

Use a vacuum cleaner to remove dust from the filters or wash them with water.

- After rinsing the air filters with water, dry them in the shade.
- Set the air filter into the air conditioner.

Cleaning of panel and air filter

- Wipe down the panel and air filter with a sponge or towel moistened with a kitchen detergent. (Do not use any metallic brush for cleaning.)
- Carefully rinse the panel and air filter to wash out the detergent.
- After rinsing the panel and air filter with water, dry it in the shade.

1. Close the suction grille.
 - Close the suction grille, slide the knob outward, and fix the suction grille securely.

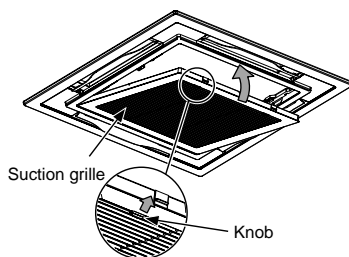

Cleaning of Air Filters

- If the air filters are not cleaned, it not only reduce the cooling a performance of air conditioner but causes a failure in the air conditioner such as water falling in drops.

Preparation :

1. Stop the operation by remote controller.
2. Dismount the air filter.

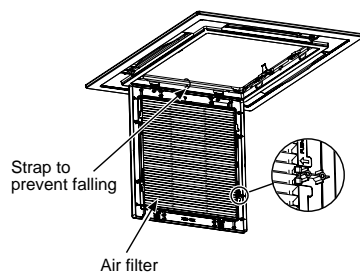

2. Push  button.
 - "FILTER  " disappears.

CAUTION

- Do not start the air conditioner while leaving the panel and air filter removed.
- Push the filter reset button. ( indication will be turn off.)

Cleaning of discharge louver

The discharge louver can be removed to clean.

1. Remove the discharge louver.
 - Holding the both ends of the discharge louver, remove the louver sagging the center downward.

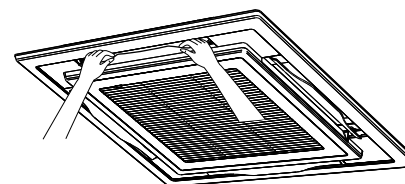

3. Mount the discharge louver.
 - First push in one side of the louver, and then insert the other side sagging the center downward.

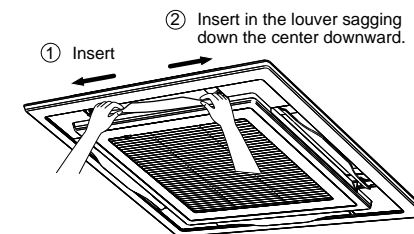

Be careful to the direction of the louver when mounting.

Mount the louver so that the side with the mark faces upward and the arrow direction of the mark directs.

2. Cleaning with water
 - If the dirt is terrible, clean the louver by tepid water with neutral detergent or water.

REQUIREMENT

Be sure to clean the heat exchanger with pressurized water.

If a commercially available detergent (strong alkaline or acid) cleaning agent is used, the surface treatment of the heat exchanger will be marred, which may degrade the self cleaning performance.

For details, contact the dealer.

NOTE

ANNUAL MAINTENANCE

- For environmental conservation, it is strongly recommended that the indoor and outdoor units of the air conditioner in use be cleaned operation of the air conditioner. When the air conditioner is operated for a long time, periodic maintenance (once a year) is recommended. Furthermore, regularly check the outdoor unit for rust and scratches, and remove them or apply rustproof treatment, if necessary. As a general rule, when an indoor unit is operated for 8 hours or more daily, clean the indoor unit and outdoor unit at least once every 3 months. Ask a professional for this cleaning/ maintenance work. Such maintenance can extend the life of the product though it involves the owner's expense. Failure to clean the indoor and outdoor units regularly will result in poor performance, freezing, water leakage, and even compressor failure.
- This product incorporates a drain pump. If it is used in a place full of dust or oil mist, the pump will be clogged and proper drainage is disabled. Clean the drain pump periodically. For how to clean the drain pump, contact the dealer.

10 MAINTENANCE

Maintenance List

Part	Check (visual/auditory)	Maintenance
Heat exchanger	• Dust/dirt clogging, scratches	• Wash the heat exchanger when it is clogged.
Fan motor	• Sound	• Take appropriate measures when abnormal sound is generated.
Filter	• Dust/dirt, breakage	• Wash the filter with water when it is contaminated. • Replace it when it is damaged.
Fan	• Vibration, balance • Dust/dirt, appearance	• Replace the fan when vibration or balance is terrible. • Brush or wash the fan when it is contaminated.
Air inlet/outlet grilles	• Dust/dirt, scratches	• Fix or replace them when they are deformed or damaged.
Drain pan	• Dust/dirt clogging, drain contamination	• Clean the drain pan and check the downward slope for smooth drainage.
Ornamental panel, louvers	• Dust/dirt, scratches	• Wash them when they are contaminated or apply repair coating.

11 TROUBLE SHOOTING

Confirmation and check

When a trouble occurred in the air conditioner, the check code and the indoor unit No. appear on the display part of the remote controller.

The check code is only displayed during the operation.

If the display disappears, operate the air conditioner according to the following "Confirmation of error history" for confirmation.

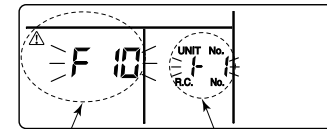

Check code Indoor unit No. in which an error occurred

Confirmation of error history

When a trouble occurred on the air conditioner, the trouble history can be confirmed with the following procedure. (The trouble history is stored in memory up to 4 troubles.)

The history can be confirmed from both operating status and stop status.

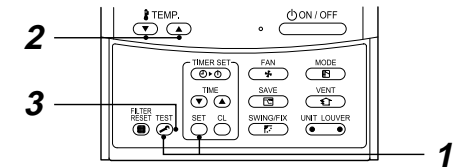

Procedure 1

When pushing **SET** and **TEST** buttons at the same time for 4 seconds or more, the following display appears.

If [Service check] is displayed, the mode enters in the trouble history mode.

- [01 : Order of trouble history] is displayed in CODE No. window.
- [Check code] is displayed in CHECK window.
- [Indoor unit address in which an error occurred] is displayed in Unit No.

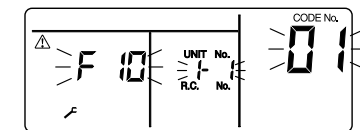

Procedure 2

Every pushing of "TEMP" button used to set temperature, the trouble history stored in memory is displayed in order.

The numbers in CODE No. indicate CODE No. [01] (latest) → [04] (oldest).

REQUIREMENT

Do not push **CL** button because all the trouble history of the indoor unit will be deleted.

Procedure 3

After confirmation, push **TEST** button to return to the usual display.

11 TROUBLE SHOOTING

■ Check codes and parts to be checked

Check method

On the remote controller (Main remote controller, Central control remote controller) and the interface P.C. board of the outdoor unit (I/F), a check display LCD (Remote controller) or 7-segment display (on the outdoor interface P.C. board) to display the operation is provided. Therefore the operation status can be known. Using this self-diagnosis function, a trouble or position with error of the air conditioner can be found as shown in the table below.

Check code list

The following list shows each check code. Find the check contents from the list according to part to be checked.

- In case of check from indoor remote controller: See "Main remote controller display" in the list.
- In case of check from outdoor unit: See "Outdoor 7-segment display" in the list.
- In case of check from AI-NET central control remote controller: See "AI-NET central control display" in the list.
- In case of check from indoor unit with a wireless remote controller: See "Sensor block display of receiving unit" in the list.

AI-NET : Artificial Intelligence, IPDU : Intelligent Power Drive Unit
 ○ : Lighting, ✻ : Flashing, ● : Goes off
 ALT : Flashing is alternately when there are two flashing LED.,
 SIM : Simultaneous flashing when there are two flashing LED.

49

Main remote controller display	Check code			Wireless remote controller			Check code name	Judging device
	Outdoor 7-segment display	AI-NET central control display	Sensor block display of receiving unit	Sensor block display of receiving unit				
				Operation	Timer	Ready		
E01	—	—	—	✻	●	●	Communication error between indoor and remote controller (Detected at remote controller side)	Remote controller
E02	—	—	—	✻	●	●	Remote controller transmission error	Remote controller
E03	—	—	97	✻	●	●	Communication error between indoor and remote controller (Detected at indoor side)	Indoor
E04	—	—	04	●	●	✻	Communication circuit error between indoor/outdoor (Detected at indoor side)	Indoor
E06	E06	No. of indoor units in which sensor has been normally received	04	●	●	✻	Decrease of No. of indoor units	I/F
—	E07	—	—	●	●	✻	Communication circuit error between indoor/outdoor (Detected at outdoor side)	I/F
E08	E08	Duplicated indoor addresses	96	✻	●	●	Duplicated indoor addresses	Indoor / I/F
E09	—	—	99	✻	●	●	Duplicated main remote controllers	Remote controller
E10	—	—	CF	✻	●	●	Communication error between indoor MCU	Indoor
E12	E12	01: Indoor/Outdoor communication 02: Communication between outdoor units	42	✻	●	●	Automatic address start error	I/F
E15	E15	—	42	●	●	✻	Indoor is nothing during automatic addressing	I/F
E16	E16	00: Capacity over 01 -: No. of connected units	89	●	●	✻	Capacity over / No. of connected indoor units	I/F
E18	—	—	97, 99	✻	●	●	Communication error between indoor units	Indoor
E19	E19	00: Header is nothing 02: Two or more header units	96	●	●	✻	Outdoor header units quantity error	I/F
E20	E20	01: Outdoor of other line connected 02: Indoor of other line connected	42	●	●	✻	Other line connected during automatic address	I/F
E23	E23	—	15	●	●	✻	Sending error in communication between outdoor units	I/F
E25	E25	—	15	●	●	✻	Duplicated follower outdoor addresses	I/F
E26	E26	No. of outdoor units which received signal normally	15	●	●	✻	Decrease of No. of connected outdoor units	I/F
E28	E28	Detected outdoor unit number	d2	●	●	✻	Follower outdoor unit error	I/F
E31	E31	01: IPDU1 error 02: IPDU2 error 03: IPDU1_2 error 04: Fan IPDU error 05: IPDU + Fan IPDU error 06: IPDU2 + Fan IPDU error 07: All IPDU error	CF	●	●	✻	IPDU communication error	I/F

Main remote controller display	Check code			Wireless remote controller			Check code name	Judging device	
	Outdoor 7-segment display	AI-NET central control display	Sensor block display of receiving unit	Sensor block display of receiving unit					
				Operation	Timer	Ready			Flash
F01	—	—	0F	✻	✻	●	ALT	Indoor TCJ sensor error	Indoor
F02	—	—	0d	✻	✻	●	ALT	Indoor TC2 sensor error	Indoor
F03	—	—	93	✻	✻	●	ALT	Indoor TC1 sensor error	Indoor
F04	F04	—	19	✻	✻	○	ALT	TD1 sensor error	I/F
F05	F05	—	A1	✻	✻	○	ALT	TD2 sensor error	I/F
F06	F06	—	18	✻	✻	○	ALT	TE1 sensor error	I/F
F07	F07	—	18	✻	✻	○	ALT	TL sensor error	I/F
F08	F08	—	1b	✻	✻	○	ALT	TO sensor error	I/F
F10	—	—	OC	✻	✻	●	ALT	Indoor TA sensor error	Indoor
F12	F12	—	A2	✻	✻	○	ALT	TS1 sensor error	I/F
F13	F13	01: Comp. 1 side 02: Comp. 2 side	43	✻	✻	○	ALT	TH sensor error	IPDU
F15	F15	—	18	✻	✻	○	ALT	Outdoor temp. sensor miscabling (TE, TL)	I/F
F16	F16	—	43	✻	✻	○	ALT	Outdoor pressure sensor miscabling (Pd, Ps)	I/F
F23	F23	—	43	✻	✻	○	ALT	Ps sensor error	I/F
F24	F24	—	43	✻	✻	○	ALT	Pd sensor error	I/F
F29	—	—	12	✻	✻	●	SIM	Indoor other error	Indoor
F31	F31	—	1C	✻	✻	○	SIM	Indoor EEPROM error	I/F
H01	H01	01: Comp. 1 side 02: Comp. 2 side	1F	✻	✻	●		Compressor break down	IPDU
H02	H02	01: Comp. 1 side 02: Comp. 2 side	1d	●	✻	●		Magnet switch error Overcurrent relay operation Compressor trouble (lock)	MG-SW Overcurrent relay IPDU
H03	H03	01: Comp. 1 side 02: Comp. 2 side	17	●	✻	●		Current detect circuit system error	IPDU
H04	H04	—	44	●	✻	●		Comp 1 case thermo operation	I/F
H06	H06	—	20	●	✻	●		Low pressure protective operation	I/F
H07	H07	—	d7	●	✻	●		Oil level down detective protection	I/F
H08	H08	01: TK1 sensor error 02: TK2 sensor error 03: TK3 sensor error 04: TK4 sensor error	d4	●	✻	●		Oil level detective temp sensor error	I/F
H14	H14	—	44	●	✻	●		Comp 2 case thermo operation	I/F
H16	H16	01: TK1 oil circuit system error 02: TK2 oil circuit system error 03: TK3 oil circuit system error 04: TK4 oil circuit system error	d7	●	✻	●		Oil level detective circuit error Magnet switch error Overcurrent relay operation	I/F MG-SW Overcurrent relay
L03	—	—	96	✻	●	✻	SIM	Indoor center unit duplicated	Indoor
L04	L04	—	96	✻	○	✻	SIM	Outdoor line address duplicated	I/F
L05	—	—	96	✻	●	✻	SIM	Duplicated indoor units with priority (Displayed in indoor unit with priority)	I/F
L06	L06	No. of indoor units with priority	96	✻	●	✻	SIM	Duplicated indoor units with priority (Displayed in unit other than indoor unit with priority)	I/F
L07	—	—	99	✻	●	✻	SIM	Group line in individual indoor unit	Indoor
L08	L08	—	99	✻	●	✻	SIM	Indoor group/Address unset	Indoor, I/F
L09	—	—	46	✻	●	✻	SIM	Indoor capacity unset	Indoor
L10	L10	—	88	✻	○	✻	SIM	Outdoor capacity unset	I/F
L20	—	—	98	✻	○	✻	SIM	Duplicated central control addresses	AI-NET, Indoor
L28	L28	—	46	✻	○	✻	SIM	Over No. of connected outdoor units	I/F
L29	L29	01: IPDU1 error 02: IPDU2 error 03: IPDU3 error 04: Fan IPDU error 05: IPDU1 + Fan IPDU error 06: IPDU2 + Fan IPDU error 07: All IPDU error	CF	✻	○	✻	SIM	No. of IPDU error	I/F
L30	L30	Detected indoor address	b6	✻	○	✻	SIM	Indoor outside interlock	Indoor
—	L31	—	—	—	—	—		Extended I/C error	I/F

11 TROUBLE SHOOTING

Main remote controller display	Check code		Wireless remote controller				Check code name	Judging device	
	Outdoor 7-segment display	AI-NET central control display	Sensor block display of receiving unit						
			Operation	Timer	Ready	Flash			
P01	—	—	11	●	□	□	ALT	Indoor fan motor error	Indoor
P03	P03	—	1E	□	●	□	ALT	Discharge temp. TD1 error	I/F
P04	P04	01: Comp. 1 side 02: Comp. 2 side	21	□	●	□	ALT	High-pressure SW system operation	IPDU
P05	P05	01: Phase-missing detection 02: Phase error	AF	□	●	□	ALT	Phase-missing detection /Phase error	I/F
P07	P07	01: Comp. 1 side 02: Comp. 2 side	IC	□	●	□	ALT	Heat sink overheat error	IPDU, I/F
P10	P10	Detected indoor address	Ob	●	□	□	ALT	Indoor overflow error	Indoor
P12	—	—	11	●	□	□	ALT	Indoor fan motor error	Indoor
P13	P13	—	47	●	□	□	ALT	Outdoor liquid back detection error	I/F
P15	P15	01: TS conditio 02: TD condition	AE	□	●	□	ALT	Gas leak detection	I/F
P17	P17	—	bb	□	●	□	ALT	Discharge temp. TD2 error	I/F
P19	P19	Detected outdoor unit number	O8	□	●	□	ALT	4-way valve inverse error	I/F
P20	P20	—	22	□	●	□	ALT	High-pressure protective operation	I/F
P22	P22	0 — : IGBT short 1 — : Fan motor position detective circuit error 3 — : Fan motor trouble C — : TH sensor temp. error (Heat sink overheat) D — : TH sensor error E — : Vdc output error	1A	□	●	□	ALT	Outdoor fan IPDU error	IPDU
P26	P26	01: Comp. 1 side 02: Comp. 2 side	14	□	●	□	ALT	G-TR short protection error	IPDU
P29	P29	01: Comp. 1 side 02: Comp. 2 side	16	□	●	□	ALT	Comp position detective circuit system error	IPDU
P31	P31	—	47	□	●	□	ALT	Other indoor unit error (Group terminal unit error)	Indoor
—	—	—	b7	By alarm device		—	ALT	Error in indoor group	AI-NET
—	—	—	97	—		—	—	AI-NET communication system error	AI-NET
—	—	—	99	—		—	—	Duplicated network adapters	AI-NET

Error detected by TCC-LINK central control device

Central control device indication	Check code		Wireless remote controller				Check code name	Judging device	
	Outdoor 7-segment display	AI-NET central control display	Sensor block display of receiving unit						
			Operation	Timer	Ready	Flash			
C05	—	—	—	—				Sending error in TCC-LINK central control device	TCC-LINK
C06	—	—	—	—				Receiving error in TCC-LINK central control device	TCC-LINK
C12	—	—	—	—				Batch alarm of general-purpose equipment control interface	General-purpose equipment, I/F
P30	Differs according to error contents of unit with occurrence of alarm		—				Group control branching unit error	TCC-LINK	
	—	—	(L20 is displayed.)				Duplicated central control addresses		

TCC-LINK : TOSHIBA Carrirea Cominication Link.

5. REFRIGERATING CYCLE DIAGRAM

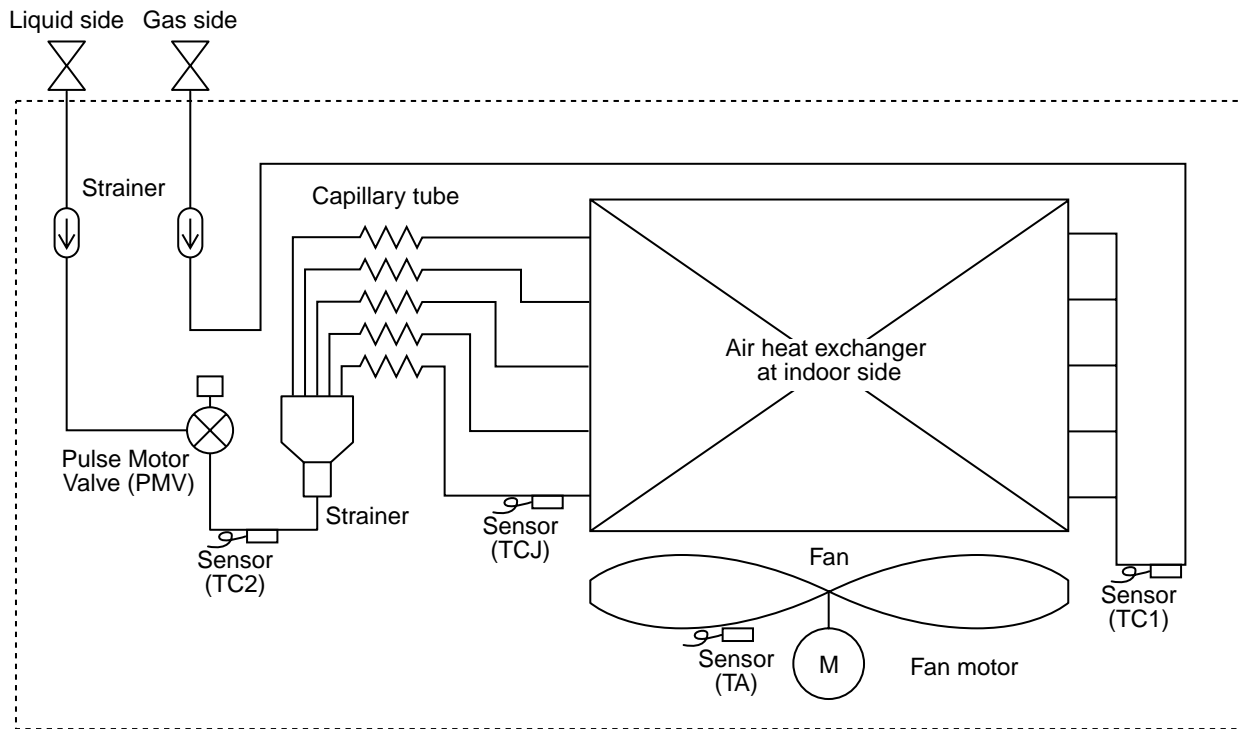

Functional part name		Functional outline
Pulse Motor Valve	PMV	(Connector CN082 (6P): Blue) 1) Controls super heat in cooling operation 2) Controls under cool in heating operation 3) Recovers refrigerant oil in cooling operation 4) Recovers refrigerant oil in heating operation
Temp. sensor	1. TA	(Connector CN104 (2P): Yellow) 1) Detects indoor suction temperature
	2. TC1	(Connector CN100 (3P): Brown) 1) Controls PMV super heat in cooling operation
	3. TC2	(Connector CN101 (2P): Black) 1) Controls PMV under cool in heating operation
	4. TCJ	(Connector CN102 (2P): Red) 1) Controls PMV super heat in cooling operation

6. CONTROL OUTLINE

6-1. Control Specifications

No.	Item	Outline of specifications	Remarks														
1	When power supply is reset	1) Distinction of outdoor unit When the power supply is reset, the outdoors are distinguished and the control is selected according to the distinguished result. 2) Setting of indoor fan speed and existence of air direction adjustment Based on EEPROM data, select setting of the indoor fan speed and the existence of air direction adjustment. 3) If resetting the power supply during occurrence of a trouble, the check code is once cleared. After ON/OFF button of the remote controller was pushed and the operation was resumed, if the abnormal status continues, the check code is again displayed on the remote controller.	Air speed (rpm)/ Air direction adjustment														
2	Operation mode selection	1) Based on the operation mode selecting command from the remote controller, the operation mode is selected. <table border="1" style="margin: 10px auto; border-collapse: collapse; width: 80%;"> <thead> <tr> <th style="text-align: center;">Remote controller command</th> <th style="text-align: center;">Control outline</th> </tr> </thead> <tbody> <tr> <td style="text-align: center;">STOP</td> <td>Air conditioner stops.</td> </tr> <tr> <td style="text-align: center;">FAN</td> <td>Fan operation</td> </tr> <tr> <td style="text-align: center;">COOL</td> <td>Cooling operation</td> </tr> <tr> <td style="text-align: center;">DRY</td> <td>Dry operation</td> </tr> <tr> <td style="text-align: center;">HEAT</td> <td>Heating operation</td> </tr> <tr> <td style="text-align: center;">AUTO (SHRM only)</td> <td> <ul style="list-style-type: none"> Ta and Ts automatically select COOL/ HEAT operation mode for operation. The operation is performed as shown in the following figure according to Ta value at the first time only. (In the range of $T_s - 1 < T_a < T_s + 1$, Cooling thermo. OFF (Fan) / Setup air volume operation continues.) <div style="text-align: center; margin-top: 10px;"> </div> </td> </tr> </tbody> </table> <p style="font-size: small; margin-top: 10px;">* In the SHRM, the automatic mode cannot be selected. While a wireless remote controller is used, the mode is notified by "Pi Pi" (two times) receiving sound and the alternate flashing of [TIMER ☹] and [READY ☺]. To clear the alternate flashing, change the mode on the wireless remote controller.</p>	Remote controller command	Control outline	STOP	Air conditioner stops.	FAN	Fan operation	COOL	Cooling operation	DRY	Dry operation	HEAT	Heating operation	AUTO (SHRM only)	<ul style="list-style-type: none"> Ta and Ts automatically select COOL/ HEAT operation mode for operation. The operation is performed as shown in the following figure according to Ta value at the first time only. (In the range of $T_s - 1 < T_a < T_s + 1$, Cooling thermo. OFF (Fan) / Setup air volume operation continues.) <div style="text-align: center; margin-top: 10px;"> </div>	Ta: Room temp. Ts: Setup temp.
Remote controller command	Control outline																
STOP	Air conditioner stops.																
FAN	Fan operation																
COOL	Cooling operation																
DRY	Dry operation																
HEAT	Heating operation																
AUTO (SHRM only)	<ul style="list-style-type: none"> Ta and Ts automatically select COOL/ HEAT operation mode for operation. The operation is performed as shown in the following figure according to Ta value at the first time only. (In the range of $T_s - 1 < T_a < T_s + 1$, Cooling thermo. OFF (Fan) / Setup air volume operation continues.) <div style="text-align: center; margin-top: 10px;"> </div>																
3	Room temp. control	1) Adjustment range: Remote controller setup temperature (°C) <table border="1" style="margin: 10px auto; border-collapse: collapse; width: 80%;"> <thead> <tr> <th></th> <th style="text-align: center;">COOL/DRY</th> <th style="text-align: center;">HEAT</th> <th style="text-align: center;">AUTO*</th> </tr> </thead> <tbody> <tr> <td style="text-align: center;">Wired type</td> <td style="text-align: center;">18 to 29</td> <td style="text-align: center;">18 to 29</td> <td style="text-align: center;">18 to 29</td> </tr> <tr> <td style="text-align: center;">Wireless type</td> <td style="text-align: center;">18 to 30</td> <td style="text-align: center;">16 to 30</td> <td style="text-align: center;">17 to 27</td> </tr> </tbody> </table>		COOL/DRY	HEAT	AUTO*	Wired type	18 to 29	18 to 29	18 to 29	Wireless type	18 to 30	16 to 30	17 to 27	* For SHRM only		
	COOL/DRY	HEAT	AUTO*														
Wired type	18 to 29	18 to 29	18 to 29														
Wireless type	18 to 30	16 to 30	17 to 27														

No.	Item	Outline of specifications	Remarks												
3	Room temp. control (Continued)	2) Using the Item code 06, the setup temperature in heating operation can be corrected. <table border="1" data-bbox="453 286 1102 371"> <thead> <tr> <th>Setup data</th> <th>0</th> <th>2</th> <th>4</th> <th>6</th> </tr> </thead> <tbody> <tr> <td>Setup temp. correction</td> <td>+0°C</td> <td>+2°C</td> <td>+4°C</td> <td>+6°C</td> </tr> </tbody> </table> Setting at shipment <table border="1" data-bbox="453 427 740 472"> <tbody> <tr> <td>Setup data</td> <td>2</td> </tr> </tbody> </table>	Setup data	0	2	4	6	Setup temp. correction	+0°C	+2°C	+4°C	+6°C	Setup data	2	Shift of suction temperature in heating operation Except while sensor of the remote controller is controlled (Code No. [32], "0001")
Setup data	0	2	4	6											
Setup temp. correction	+0°C	+2°C	+4°C	+6°C											
Setup data	2														
4	Automatic capacity control	1) Based on the difference between Ta and Ts, the operation capacity is determined by the outdoor unit. <div style="display: flex; justify-content: space-around; align-items: flex-start;"> <div data-bbox="469 622 735 1010"> <p style="text-align: center;">COOL</p> </div> <div data-bbox="815 622 1091 1010"> <p style="text-align: center;">HEAT</p> </div> </div>	Ts: Setup temp. Ta: Room temp.												
5	Automatic cooling/heating control	1) The judgment of selecting COOL/HEAT is carried out as shown below. When +1.5 exceeds against Tsh 10 minutes and after thermo.-OFF, heating operation (Thermo. OFF) exchanges to cooling operation. Description in the parentheses shows an example of cooling ON/OFF. <div style="text-align: center;"> </div> <p>When -1.5 lowers against Tsc 10 minutes and after thermo. OFF, cooling operation (Thermo. OFF) exchanges to heating operation.</p> 2) For the automatic capacity control after judgment of cooling/heating, see Item 4. 3) For temperature correction of room temp. control in automatic heating, see Item 3.	* For SHRM only Tsc: Setup temp. in cooling operation Tsh: Setup temp. in heating operation + temp. correction of room temp. control												

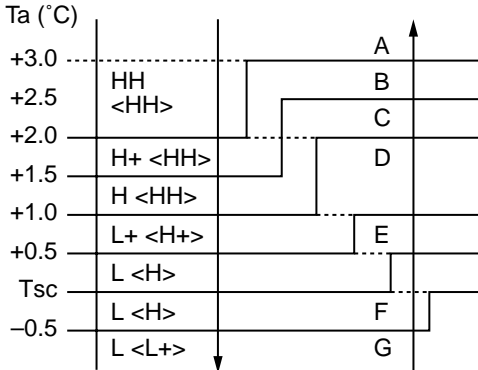
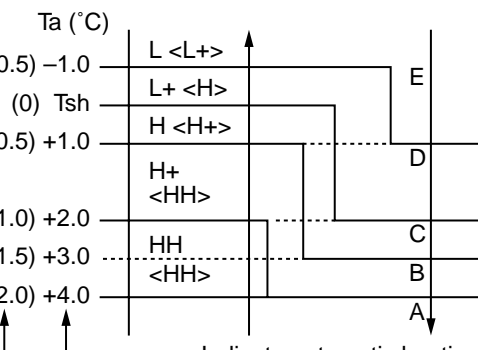
No.	Item	Outline of specifications	Remarks
6	Air speed selection	<p>1) Operation with (HH), (H), (L) or [AUTO] mode is carried out by the command from the remote controller.</p> <p>2) When the air speed mode [AUTO] is selected, the air speed varies by the difference between Ta and Ts.</p> <p><COOL></p>  <p style="text-align: center;">< > : Indicate automatic cooling.</p> <ul style="list-style-type: none"> Controlling operation in case when thermo of remote controller works is same as a case when thermo of the body works. If the air speed has been changed once, it is not changed for 3 minutes. However when the air volume is exchanged, the air speed changes. When cooling operation has started, select a downward slope for the air speed, that is, the high position. If the temperature is just on the difference boundary, the air speed does not change. <p><HEAT></p>  <p style="text-align: center;">< > : Indicate automatic heating.</p> <p>Body thermostat works. Remote controller thermostat works.</p> <p>Value in the parentheses indicates one when thermostat of the remote controller works. Value without parentheses indicates one when thermostat of the body works.</p> <ul style="list-style-type: none"> If the air speed has been changed once, it is not changed for 1 minute. However when the air speed exchanged, the air speed changes. When heating operation has started, select an upward slope for the air speed, that is, the high position. If the temperature is just on the difference boundary, the air speed does not change. In $Tc2 \geq 60^{\circ}C$, the air speed increases by 1 step. 	<p>HH > H+ > H > L+ > L > UL</p> <p>Code No. 32 0000: Body thermo. (Main unit) 0001: Remote controller thermo.</p> <p>Tc2: Indoor heat exchanger sensor temperature</p>



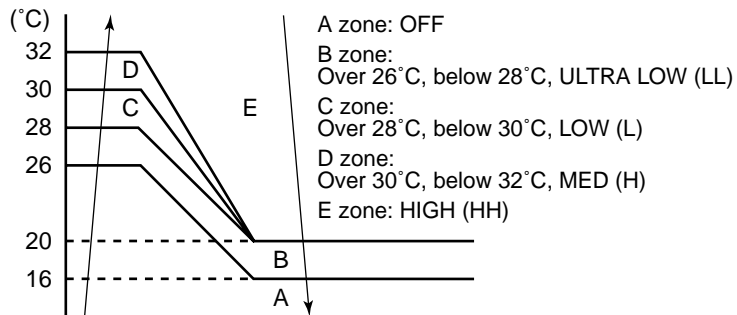

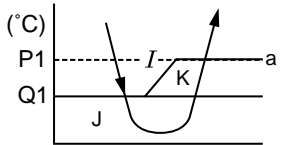
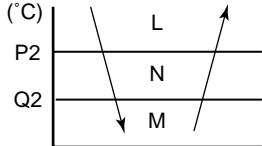
No.	Item	Outline of specifications	Remarks																																																																																																																																																								
6	Air speed selection (Continued): In case of 4-way Discharge Cassette type	<table border="1" data-bbox="534 353 1428 981"> <thead> <tr> <th rowspan="2">CODE No. [5d]</th> <th colspan="2">Standard</th> <th colspan="2">Type 1</th> <th colspan="2">Type 3</th> <th colspan="2">Type 6</th> </tr> <tr> <th colspan="2">0000</th> <th colspan="2">0001</th> <th colspan="2">0003</th> <th colspan="2">0006</th> </tr> <tr> <th>SW501 (1)/(2)</th> <th colspan="2">OFF/OFF</th> <th colspan="2">ON/OFF</th> <th colspan="2">OFF/ON</th> <th colspan="2">ON/ON</th> </tr> <tr> <th>Tap</th> <th>HEAT</th> <th>COOL</th> <th>HEAT</th> <th>COOL</th> <th>HEAT</th> <th>COOL</th> <th>HEAT</th> <th>COOL</th> </tr> </thead> <tbody> <tr><td>F1</td><td></td><td></td><td></td><td></td><td>HH</td><td>HH</td><td>HH</td><td>HH</td></tr> <tr><td>F2</td><td></td><td></td><td>HH</td><td>HH</td><td></td><td></td><td></td><td></td></tr> <tr><td>F3</td><td></td><td></td><td></td><td>H+</td><td>H+, H</td><td>H+, H</td><td>H+, H L+, L</td><td>H+, H L+, L</td></tr> <tr><td>F4</td><td></td><td></td><td>H+</td><td></td><td></td><td></td><td></td><td></td></tr> <tr><td>F5</td><td></td><td>HH</td><td></td><td>H</td><td></td><td></td><td></td><td></td></tr> <tr><td>F6</td><td>HH</td><td></td><td>H</td><td></td><td>L+</td><td>L+</td><td></td><td></td></tr> <tr><td>F7</td><td>H+</td><td>H+</td><td></td><td></td><td>L</td><td>L</td><td></td><td></td></tr> <tr><td>F8</td><td></td><td>H</td><td></td><td>L+</td><td></td><td></td><td></td><td></td></tr> <tr><td>F9</td><td>H</td><td></td><td>L+</td><td>L</td><td></td><td></td><td></td><td></td></tr> <tr><td>FA</td><td></td><td>L+</td><td>L</td><td></td><td></td><td></td><td></td><td></td></tr> <tr><td>FB</td><td>L+</td><td>L</td><td></td><td></td><td></td><td></td><td></td><td></td></tr> <tr><td>FC</td><td>L</td><td></td><td></td><td></td><td></td><td></td><td></td><td></td></tr> <tr><td>FD</td><td>LL</td><td>LL</td><td>LL</td><td>LL</td><td>LL</td><td>LL</td><td>LL</td><td>LL</td></tr> </tbody> </table> <p data-bbox="518 1003 1396 1030">3) In heating operation, the mode changes to [LL] if thermostat is turned off.</p>	CODE No. [5d]	Standard		Type 1		Type 3		Type 6		0000		0001		0003		0006		SW501 (1)/(2)	OFF/OFF		ON/OFF		OFF/ON		ON/ON		Tap	HEAT	COOL	HEAT	COOL	HEAT	COOL	HEAT	COOL	F1					HH	HH	HH	HH	F2			HH	HH					F3				H+	H+, H	H+, H	H+, H L+, L	H+, H L+, L	F4			H+						F5		HH		H					F6	HH		H		L+	L+			F7	H+	H+			L	L			F8		H		L+					F9	H		L+	L					FA		L+	L						FB	L+	L							FC	L								FD	LL	LL	LL	LL	LL	LL	LL	LL	Selection of high ceiling type CODE No. : [5d] or selection of high ceiling on P.C. board SW501
CODE No. [5d]	Standard			Type 1		Type 3		Type 6																																																																																																																																																			
	0000		0001		0003		0006																																																																																																																																																				
SW501 (1)/(2)	OFF/OFF		ON/OFF		OFF/ON		ON/ON																																																																																																																																																				
Tap	HEAT	COOL	HEAT	COOL	HEAT	COOL	HEAT	COOL																																																																																																																																																			
F1					HH	HH	HH	HH																																																																																																																																																			
F2			HH	HH																																																																																																																																																							
F3				H+	H+, H	H+, H	H+, H L+, L	H+, H L+, L																																																																																																																																																			
F4			H+																																																																																																																																																								
F5		HH		H																																																																																																																																																							
F6	HH		H		L+	L+																																																																																																																																																					
F7	H+	H+			L	L																																																																																																																																																					
F8		H		L+																																																																																																																																																							
F9	H		L+	L																																																																																																																																																							
FA		L+	L																																																																																																																																																								
FB	L+	L																																																																																																																																																									
FC	L																																																																																																																																																										
FD	LL	LL	LL	LL	LL	LL	LL	LL																																																																																																																																																			
7	Prevention of cold air discharge	<p data-bbox="518 1115 1077 1254">1. In heating operation, the higher temperature of TC2 sensor and TCJ sensor is compared with temperature of TC1 sensor and then the lower temperature is used to set the upper limit of the fan tap.</p> <ul data-bbox="550 1265 1061 1377" style="list-style-type: none"> • When B zone has continued for 6 minutes, the operation shifts to C zone. • In defrost time, the control point is set to +6°C. 	<p data-bbox="1117 1115 1428 1164">TCJ: Temperature of indoor heat exchanger sensor</p> <ul data-bbox="1117 1176 1444 1299" style="list-style-type: none"> • In D and E zones, priority is given to remote controller air speed setup. • In A zone “⊗” is displayed. 																																																																																																																																																								





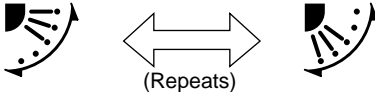



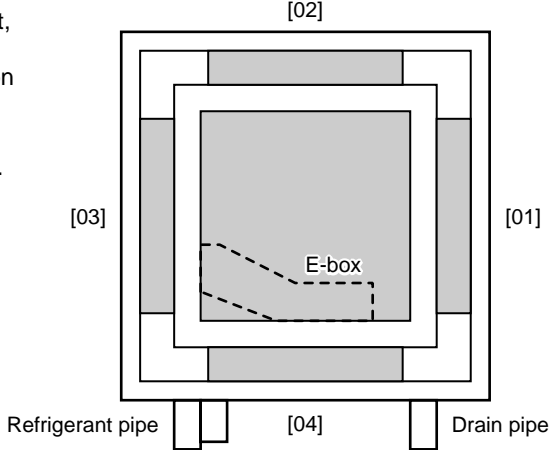

No.	Item	Outline of specifications	Remarks															
8	Freeze prevention control (Low temp. release)	<p>1. In all cooling operation, the air conditioner operates as de-scribed below based upon temp. detected by TC1, TC2 and TCJ sensors.</p> <ul style="list-style-type: none"> • When “J” zone is detected for 5 minutes, the thermostat is forcedly off. • In “K” zone, the timer count is interrupted, and held. • When “I” zone is detected, the timer is cleared and the operation returns to the normal operation. • If “J” zone continues, operation of the indoor fan in LOW mode continues until it reaches the “I” zone. It is reset when the following conditions are satisfied. <p>Reset conditions</p> <p>1) TC1 > 12°C and TC2 > 12°C and TCJ > 12°C</p> <p>2) 20 minutes passed after stop.</p>  <table border="1" data-bbox="754 750 1074 862"> <thead> <tr> <th></th> <th>TC1</th> <th>TC2, TCJ</th> </tr> </thead> <tbody> <tr> <td>P1</td> <td>10°C (5°C)</td> <td>-10°C</td> </tr> <tr> <td>Q1</td> <td>0°C</td> <td>-14°C</td> </tr> </tbody> </table> <p>2. In all cooling operation, the air conditioner operates as described below based upon temp. detected by TC2 and TCJ sensors.</p> <ul style="list-style-type: none"> • When “M” zone is detected for 45 minutes, the thermostat is forcedly off. • In “N” zone, the timer count is interrupted and held. • When shifting to “M” zone again, the timer count restarts and continues. • If “L” zone is detected, the timer is cleared and the operation returns to normal operation. <p>Reset conditions</p> <p>1) TC1 > 12°C and TC2 > 12°C and TCJ > 12°C</p> <p>2) 20 minutes passed after stop.</p>  <table border="1" data-bbox="807 1435 1074 1547"> <thead> <tr> <th></th> <th>TC2, TCJ</th> </tr> </thead> <tbody> <tr> <td>P2</td> <td>5°C</td> </tr> <tr> <td>Q2</td> <td>-2.0°C</td> </tr> </tbody> </table>		TC1	TC2, TCJ	P1	10°C (5°C)	-10°C	Q1	0°C	-14°C		TC2, TCJ	P2	5°C	Q2	-2.0°C	<p>TC1: Temperature of indoor heat exchanger sensor</p> <p>() value: When the power supply is turned on, the Forced thermo becomes OFF if the temperature is less than this indicated temperature.</p> <p>* In a Model without TC2, TC2 is not judged.</p>
	TC1	TC2, TCJ																
P1	10°C (5°C)	-10°C																
Q1	0°C	-14°C																
	TC2, TCJ																	
P2	5°C																	
Q2	-2.0°C																	
9	Recovery control for cooling oil (Refrigerant)	<p>The indoor unit which is under STOP/Thermo-OFF status or which operates in [FAN] mode performs the following controls when it received the cooling oil (Refrigerant) recovery signal from the outdoor unit.</p> <ol style="list-style-type: none"> 1) Opens PMV of the indoor unit with a constant opening degree. 2) Operates the drain pump for approx. 1 minute during recovery control and after finish of control. 	<ul style="list-style-type: none"> • Recovery operation is usually performed every 2 hours. 															

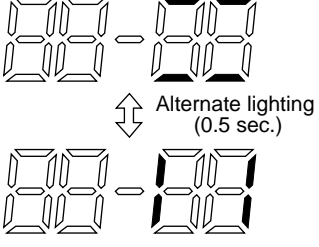
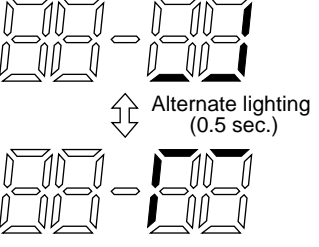
No.	Item	Outline of specifications	Remarks		
10	Recovery control for heating refrigerant (Oil)	<p>The indoor unit which is under STOP/Thermo-OFF status or which operates in [FAN] mode performs the following controls when it received the heating refrigerant (Oil) recovery signal from the outdoor unit.</p> <ol style="list-style-type: none"> 1) Opens PMV of the indoor unit with a constant opening degree. 2) Detects temperature of TC2 and then closes PMV. 3) Counts No. of recovery controls and operates the indoor fan and the drain pump for approx. 1 minute after finish of recovery control until the control count reaches the specified count. 	<ul style="list-style-type: none"> • The indoor unit which is under thermo-OFF (COOL) status or which operates in [FAN] mode stops the indoor fan and displays [READY Ⓢ]. • Recovery operation is usually performed every 1 hour. 		
11	Compensation control for short intermittent operation	<ol style="list-style-type: none"> 1) For 3 minutes after start of operation, the operation is forcedly continued even if the unit enters in Thermo-OFF condition. 2) However the thermostat is OFF giving prior to COOL/HEAT selection, READY Ⓢ for operation and protective control. 	Usually the priority is given to 5 minutes at outdoor controller side.		
12	Drain pump control	<ol style="list-style-type: none"> 1) In cooling operation (including DRY operation), this control anytime operates the drain pump. 2) During operation of the drain pump, if the float switch operates, the drain pump continuously operates and a check code is issued. 3) During stop status of the drain pump, if the float switch operates, the thermostat is forcedly off and this control operates the drain pump. After continuous operation of the float switch for approx. 5 minutes, this control stops the operation and a check code is issued. 	Check Code [P10]		
13	Elimination of retained heat	<ol style="list-style-type: none"> 1) When the unit stopped from [HEAT] operation, the indoor fan operates with [L] for approx. 30 seconds. 			
14	HA control	<ol style="list-style-type: none"> 1) ON/OFF operation is available by input of HA signal from the remote site when connected to remote controller or the remote ON/OFF interface. 2) HA control outputs ON/OFF status to HA terminal. 3) The I/O specifications of HA conform to JEMA standard. 	<p>When using HA terminal (CN61) for the remote ON/OFF, a connector sold separately is necessary.</p> <p>In case of group operation, use the connector to connect HA terminal to either master or follower indoor unit.</p>		
15	<p>Display of filter sign [■■■] (Not provided to the wireless type)</p> <p>* Separately set type TCB-AX21E2 is prepared.</p>	<ol style="list-style-type: none"> 1) The filter sign is displayed with LC by sending the filter-reset signal to the remote controller when the specified time (150H/2500H) elapsed as a result of integration of the operation time of the indoor fan. 2) The integrated timer is cleared when the filter-reset signal is received from the remote controller. In this time, if the specified time elapsed, the counted time is reset and the LC display is deleted. <table border="1" data-bbox="483 1872 860 1912" style="margin-left: auto; margin-right: auto;"> <tr> <td style="padding: 2px;">Filter time</td> <td style="padding: 2px;">2500H</td> </tr> </table>	Filter time	2500H	[■■■ FILTER] goes on.
Filter time	2500H				

No.	Item	Outline of specifications	Remarks																																																																																						
16	Display of [READY] [HEAT READY]	<p>< READY > Displayed on the remote controller</p> <ol style="list-style-type: none"> 1) When the following check codes are indicated <ul style="list-style-type: none"> • Open phase of power supply wiring [P05] was detected. • There is an indoor unit that detected the indoor overflow [P10]. • There is an indoor unit that detected the interlock alarm [L30]. 2) During Force Thermo-OFF <ul style="list-style-type: none"> • [COOL/DRY] operation is unavailable because the other indoor unit operates with [HEAT] mode. • [HEAT] operation is unavailable because COOL priority (SW11-bit1 of the Outdoor I/F P. C. board is ON) is set and the other indoor unit operates with [COOL/DRY] mode. 3) The above indoor units that cannot operate stay in Thermo-OFF status. 4) The indoor fan stops because the system performs [Recovery operation for heating refrigerant (Oil)]. <p><HEAT READY > Displayed on the remote controller The indoor fan stops in order to prevent discharge of cool air when heating operation started or during heating operation. (including the defrost operation during thermo-OFF)</p>	<ul style="list-style-type: none"> • < READY > display No display for wireless type remote controller • <HEAT READY > display 																																																																																						
17	Selection of central control mode	<ol style="list-style-type: none"> 1) Selection of the contents that can be operated by the remote controller at the indoor unit side is possible according to setting at the central controller side. 2) Setting contents <p>• In case of AI-NET central control</p> <table border="1" data-bbox="231 1099 1422 1285"> <thead> <tr> <th rowspan="2">Operation from AI-NET central control</th> <th colspan="6">Operation on RBC-AMT32E</th> <th rowspan="2">On RBC-AMT32E</th> </tr> <tr> <th>ON/OFF setting</th> <th>Operation selection</th> <th>Timer setting</th> <th>Temp. setting</th> <th>Air speed setting</th> <th>Air direction setting</th> </tr> </thead> <tbody> <tr> <td>[After-push priority]</td> <td>○</td> <td>○</td> <td>○</td> <td>○</td> <td>○</td> <td>○</td> <td rowspan="3">[Center controlling] display</td> </tr> <tr> <td>[Center]</td> <td>✕</td> <td>○</td> <td>✕</td> <td>○</td> <td>○</td> <td>○</td> </tr> <tr> <td>[Operation prohibited]</td> <td>✕</td> <td>✕</td> <td>✕</td> <td>✕</td> <td>✕</td> <td>✕</td> </tr> </tbody> </table> <p>(○: Operation possible ✕: Operation impossible)</p> <ul style="list-style-type: none"> • In case of wired remote controller type, [Central control] display (Goes on) in the central control mode • Display flashes when an item of the operation prohibited was changed on the remote controller. • In case of wireless remote controller type, the display lamp does not change but the contents that can be operated are same in the central control mode. <p>(*1) The operation from the wireless remote controller in the central control mode is notified with the receiving sound, Pi, Pi, Pi, Pi, Pi (5 times).</p> <p>(*1) If the operation select modes are different in the central 2 to 4 from those at the central controller side, the operations Temp. Setting, air volume setting, and air direction setting are inoperable.</p> <p>• In case of TCC-LINK central control</p> <table border="1" data-bbox="231 1753 1422 2007"> <thead> <tr> <th rowspan="2">Operation from TCC-LINK central control</th> <th colspan="6">Operation on RBC-AMT32E</th> <th rowspan="2">On RBC-AMT32E</th> </tr> <tr> <th>ON/OFF setting</th> <th>Operation selection</th> <th>Timer setting</th> <th>Temp. setting</th> <th>Air speed setting</th> <th>Air direction setting</th> </tr> </thead> <tbody> <tr> <td>Individual</td> <td>○</td> <td>○</td> <td>○</td> <td>○</td> <td>○</td> <td>○</td> <td rowspan="5">[Central control] display</td> </tr> <tr> <td>[Central 1]</td> <td>✕</td> <td>○</td> <td>✕</td> <td>○</td> <td>○</td> <td>○</td> </tr> <tr> <td>[Central 2]</td> <td>✕</td> <td>✕</td> <td>✕</td> <td>✕</td> <td>○</td> <td>○</td> </tr> <tr> <td>[Central 3]</td> <td>○</td> <td>✕</td> <td>○</td> <td>✕</td> <td>○</td> <td>○</td> </tr> <tr> <td>[Central 4]</td> <td>○</td> <td>✕</td> <td>○</td> <td>○</td> <td>○</td> <td>○</td> </tr> </tbody> </table> <p>(○: Operation possible ✕: Operation impossible)</p>	Operation from AI-NET central control	Operation on RBC-AMT32E						On RBC-AMT32E	ON/OFF setting	Operation selection	Timer setting	Temp. setting	Air speed setting	Air direction setting	[After-push priority]	○	○	○	○	○	○	[Center controlling] display	[Center]	✕	○	✕	○	○	○	[Operation prohibited]	✕	✕	✕	✕	✕	✕	Operation from TCC-LINK central control	Operation on RBC-AMT32E						On RBC-AMT32E	ON/OFF setting	Operation selection	Timer setting	Temp. setting	Air speed setting	Air direction setting	Individual	○	○	○	○	○	○	[Central control] display	[Central 1]	✕	○	✕	○	○	○	[Central 2]	✕	✕	✕	✕	○	○	[Central 3]	○	✕	○	✕	○	○	[Central 4]	○	✕	○	○	○	○	
Operation from AI-NET central control	Operation on RBC-AMT32E						On RBC-AMT32E																																																																																		
	ON/OFF setting	Operation selection	Timer setting	Temp. setting	Air speed setting	Air direction setting																																																																																			
[After-push priority]	○	○	○	○	○	○	[Center controlling] display																																																																																		
[Center]	✕	○	✕	○	○	○																																																																																			
[Operation prohibited]	✕	✕	✕	✕	✕	✕																																																																																			
Operation from TCC-LINK central control	Operation on RBC-AMT32E						On RBC-AMT32E																																																																																		
	ON/OFF setting	Operation selection	Timer setting	Temp. setting	Air speed setting	Air direction setting																																																																																			
Individual	○	○	○	○	○	○	[Central control] display																																																																																		
[Central 1]	✕	○	✕	○	○	○																																																																																			
[Central 2]	✕	✕	✕	✕	○	○																																																																																			
[Central 3]	○	✕	○	✕	○	○																																																																																			
[Central 4]	○	✕	○	○	○	○																																																																																			

No.	Item	Outline of specifications	Remarks
18	Louver control: In case of 4-way Discharge Cassette type	<p>1) Louver position setup</p> <ul style="list-style-type: none"> When the louver position is changed, the position moves necessarily to downward discharge position once to return to the set position. The louver position can be set up in the following operation range. <p>In cooling/dry operation In heating/fan operation</p>  <ul style="list-style-type: none"> In group twin/triple operation, the louver positions can be set up collectively or individually. In case that HEAT refrigerant recovery control was performed in STOP status, the louver position becomes horizontal when the operation is resumed. <p>2) Swing setup</p> <ul style="list-style-type: none"> [SWING] is displayed and the following display is repeated. <p>In all operations</p>  <ul style="list-style-type: none"> In group operation, the louver positions can be set up collectively or individually. <p>3) When the unit stopped or the warning was output, the louver is automatically set to full closed position.</p> <p>4) When PRE-HEAT (Heating ready) is displayed (Heating operation started or defrost operation is performed), heating thermo is off or self-cleaning is performed, the louver is automatically set to horizontal discharge position.</p> <p>* The louver which air direction is individually set or the locked louver closes fully when the unit stops and the louver is automatically set to horizontal discharge position when PRE-HEAT (Heating ready) is displayed, heating thermo is off.</p> <p><<Individual air direction setup>></p> <ul style="list-style-type: none"> Pushing  Louver select button enables every discharge port to set up the air direction. The louver numbers that are displayed on the display part correspond to those in the following figure. In case of no input (key operation) for approx. 5 seconds during setting of individual air direction (during displaying of louver No. on the remote controller screen), the remote controller screen returns to the normal display screen. For the air direction illustration during normal operation, the air direction of the least No. among the louvers which are block-set is displayed. While individual air direction is being set, the remote controller operation (Illustration of air direction) and operation of the real machine are linked. When selecting a case,  Louver select button is not pushed or louver No. is not displayed, the air directions of all the louvers are collectively set up. 	<p>The louver position at horizontal discharge position at under AP030 differs from that at over AP036.</p> <p>The swinging louver moves usually up to the ceiling side from the louver position of the set time.</p> <p>Setup from the remote controller without  button is unavailable.</p> <p>For the setup operation, refer to "How to set up louver individually" of Item "Setup at local site/ Others".</p> <p>Using same as the present 4-way Air Discharge Cassette Type is possible</p> 

No.	Item	Outline of specifications	Remarks														
18	Louver contro (Continued): In case of 4-way Discharge Cassette type	<p><<Selection of Swing mode>></p> <ul style="list-style-type: none"> For the Swing mode, the following three types of modes are selectable and settable by keeping Swing/Direction  button pushed for 4 seconds or more on the remote controller. <p>1) Standard (4 pieces: same phase) swing → Data: [0001 (At shipment)] When Swing operation is selected, four louvers align at the horizontal discharge position and then start the Swing operation at the same time.</p> <p>2) Dual swing → Data: [0002] When operation is selected, the louvers of louver No. [01] and [03] move to the horizontal discharge position, the louvers of louver No. [02] and [04] move to the downward discharge position and then start the Swing operation at the same time.</p> <p>3) Cycle swing → Data: [0003] When operation is selected, the louver No. [01] moves to the horizontal discharge position, [03] to the downward discharge position, [02] and [04] to the middle position and then start the Swing operation at the same time.</p> <ul style="list-style-type: none"> Three types of the swing modes can be also selected and set by the setup data of Item code (DN) [F0]. In case of selecting the Swing mode, “Dual swing” or “Cycle swing”, the following numerals is displayed at the center of the remote controller screen for approx. 3 seconds when  button was pushed to select [SWING]. (No display for the standard swing) <div style="display: flex; justify-content: space-around; align-items: center;"> <div style="text-align: center;">  <p>Dual swing</p> </div> <div style="text-align: center;">  <p>Cycle swing</p> </div> </div> <p><<Louver lock (Louver fix)>></p> <ul style="list-style-type: none"> For the air direction setup for each discharge port, the louver position can be locked during the normal operation. An arbitrary air direction of an arbitrary louver can be registered and set by keeping  button pushed for 4 seconds or more on the remote controller. The louver lock can be set by registering the setup data to Item code (DN) [F1] to [F4] according to the following table. <table border="1" data-bbox="448 1883 1102 2051"> <thead> <tr> <th>Item code</th> <th>Objective louver No.</th> <th>Setup data</th> </tr> </thead> <tbody> <tr> <td>F1</td> <td>01</td> <td rowspan="2">0000: Release (At shipment) 0001: Horizontal discharge position</td> </tr> <tr> <td>F2</td> <td>02</td> </tr> <tr> <td>F3</td> <td>03</td> <td>~</td> </tr> <tr> <td>F4</td> <td>04</td> <td>0005: Downward discharge position</td> </tr> </tbody> </table>	Item code	Objective louver No.	Setup data	F1	01	0000: Release (At shipment) 0001: Horizontal discharge position	F2	02	F3	03	~	F4	04	0005: Downward discharge position	<p>On the remote controller before the wired remote controller (RBC-AMT32E), the mode cannot be moved to the select mode even if pushing  button for a long time.</p> <p>Carry out setting operation during stop of the unit; otherwise the unit stops operation.</p> <p>The standard swing performs the same swing operation as the present operation (2 series).</p> <p>For the setting operation, refer to [How to set up type of the swings] in Item “Setup at local site/ Others”.</p> <p>On the remote controller before the wired remote controller (RBC-AMT32E), flashing showing the Swing mode is not indicated.</p> <p>On the remote controller before the wired remote controller (RBC-AMT32E),  button is not provided.</p> <p>Carry out setting operation during stop of the unit; otherwise the unit stops operation.</p>
Item code	Objective louver No.	Setup data															
F1	01	0000: Release (At shipment) 0001: Horizontal discharge position															
F2	02																
F3	03	~															
F4	04	0005: Downward discharge position															

No.	Item	Outline of specifications	Remarks																		
18	Louver control (Continued): In case of 4-way Discharge Cassette type	<ul style="list-style-type: none"> • If there is the locked louver in the unit, [] goes on the remote controller screen. • While the following controls are performed, the louvers operate even if executing the louver lock. <table border="1" data-bbox="459 353 1369 607" style="width: 100%; border-collapse: collapse; text-align: center;"> <thead> <tr> <th style="width: 5%;"></th> <th style="width: 60%;">Control which ignores lock</th> <th style="width: 35%;">Objective louver No.</th> </tr> </thead> <tbody> <tr> <td>①</td> <td>Operation stop</td> <td>Horizontal discharge position</td> </tr> <tr> <td>②</td> <td>When heating operation started</td> <td>Horizontal discharge position</td> </tr> <tr> <td>③</td> <td>Heating thermo. OFF</td> <td>Horizontal discharge position</td> </tr> <tr> <td>④</td> <td>During defrost operation</td> <td>Horizontal discharge position</td> </tr> <tr> <td>⑤</td> <td>Initialize operation</td> <td>Full-close position</td> </tr> </tbody> </table> <ul style="list-style-type: none"> • The real louver corresponding to the louver No. displayed on the remote controller screen during setting of louver lock operates swinging. 		Control which ignores lock	Objective louver No.	①	Operation stop	Horizontal discharge position	②	When heating operation started	Horizontal discharge position	③	Heating thermo. OFF	Horizontal discharge position	④	During defrost operation	Horizontal discharge position	⑤	Initialize operation	Full-close position	<p>For the setting operation, refer to [How to set louver lock] of Installation Manual.</p> <p>It is position check operation and it does not link with the real louver and air direction setup (Illustration on the remote controller screen).</p>
	Control which ignores lock	Objective louver No.																			
①	Operation stop	Horizontal discharge position																			
②	When heating operation started	Horizontal discharge position																			
③	Heating thermo. OFF	Horizontal discharge position																			
④	During defrost operation	Horizontal discharge position																			
⑤	Initialize operation	Full-close position																			
19	DC motor	<ol style="list-style-type: none"> 1) When the fan stator, positioning is performed for the starter and the rotor. (Vibrate slightly) 2) DC motor operates according to the command from the indoor controller. <p>(Note) If the fan rotates by entry of outside air, etc while the air conditioner stopped, the indoor unit may operate as the fan motor stops.</p> <p>(Note) If the fan lock was detected, the operation of the indoor unit stops and the error is displayed.</p>	Check code [P12]																		
20	Save operation	<ol style="list-style-type: none"> 1) The function [Save operation] is not provided to the Super Modular Multi series models. 	<ul style="list-style-type: none"> • If pushing [SAVE] button “  ” on the remote controller, “No function” is displayed. 																		

7. CONFIGURATION OF CONTROL CIRCUIT

7-1. Indoor Unit

7-1-1. Indoor Controller Block Diagram

1. Connection of wired remote controller

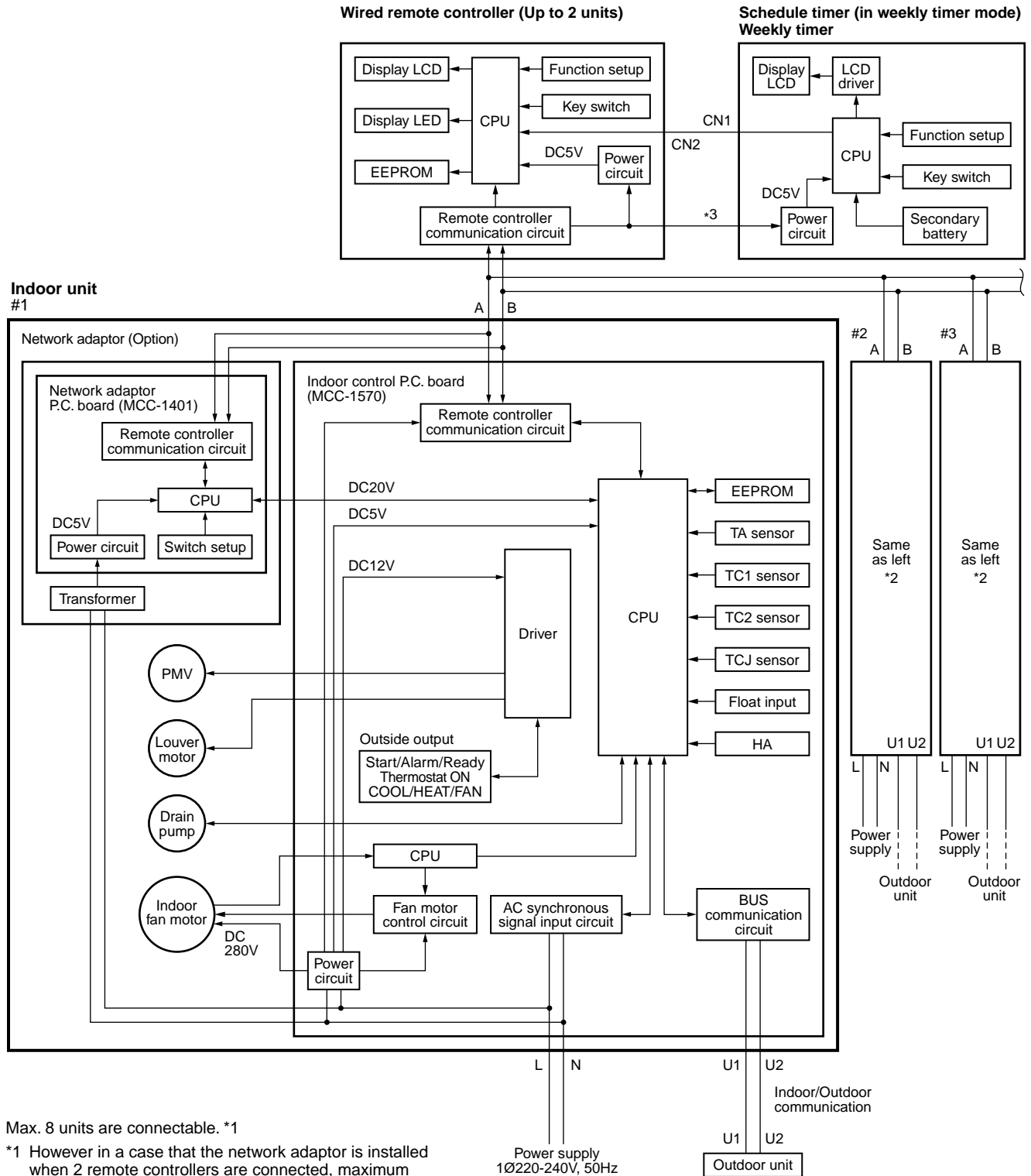

Max. 8 units are connectable. *1

*1 However in a case that the network adaptor is installed when 2 remote controllers are connected, maximum 7 units are connectable.

*2 The network adaptor is installed to only one unit.

*3 The weekly timer cannot be connected to the simple wired remote controller.

2. Connection of wireless remote controller kit

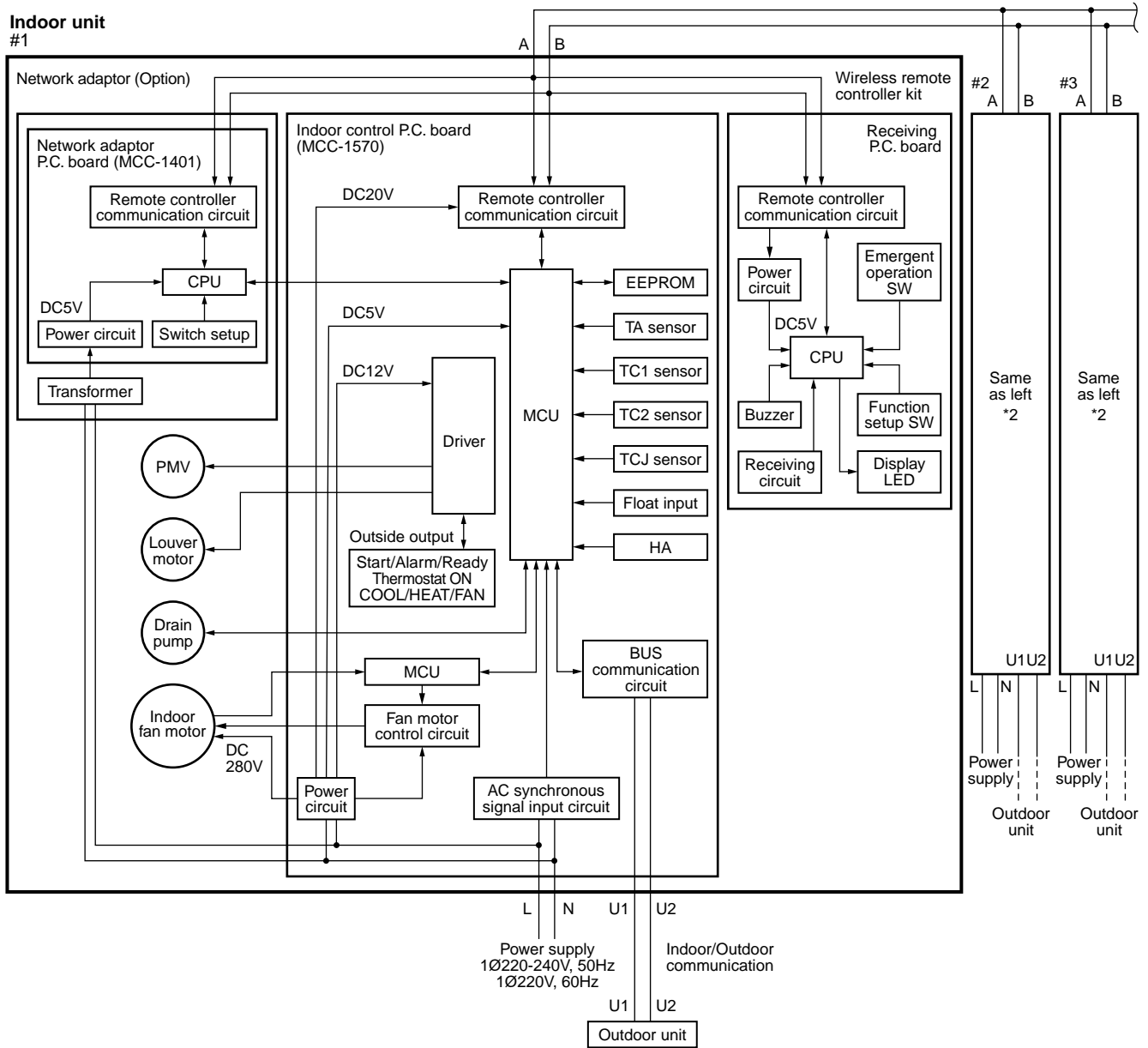

Max. 8 units are connectable. *1

*1 However in a case that the network adaptor is installed when 2 wireless remote controller kits are connected, maximum 7 units are connectable.

*2 The network adaptor is installed to only

3. Connection of both wired remote controller and wireless remote controller kit

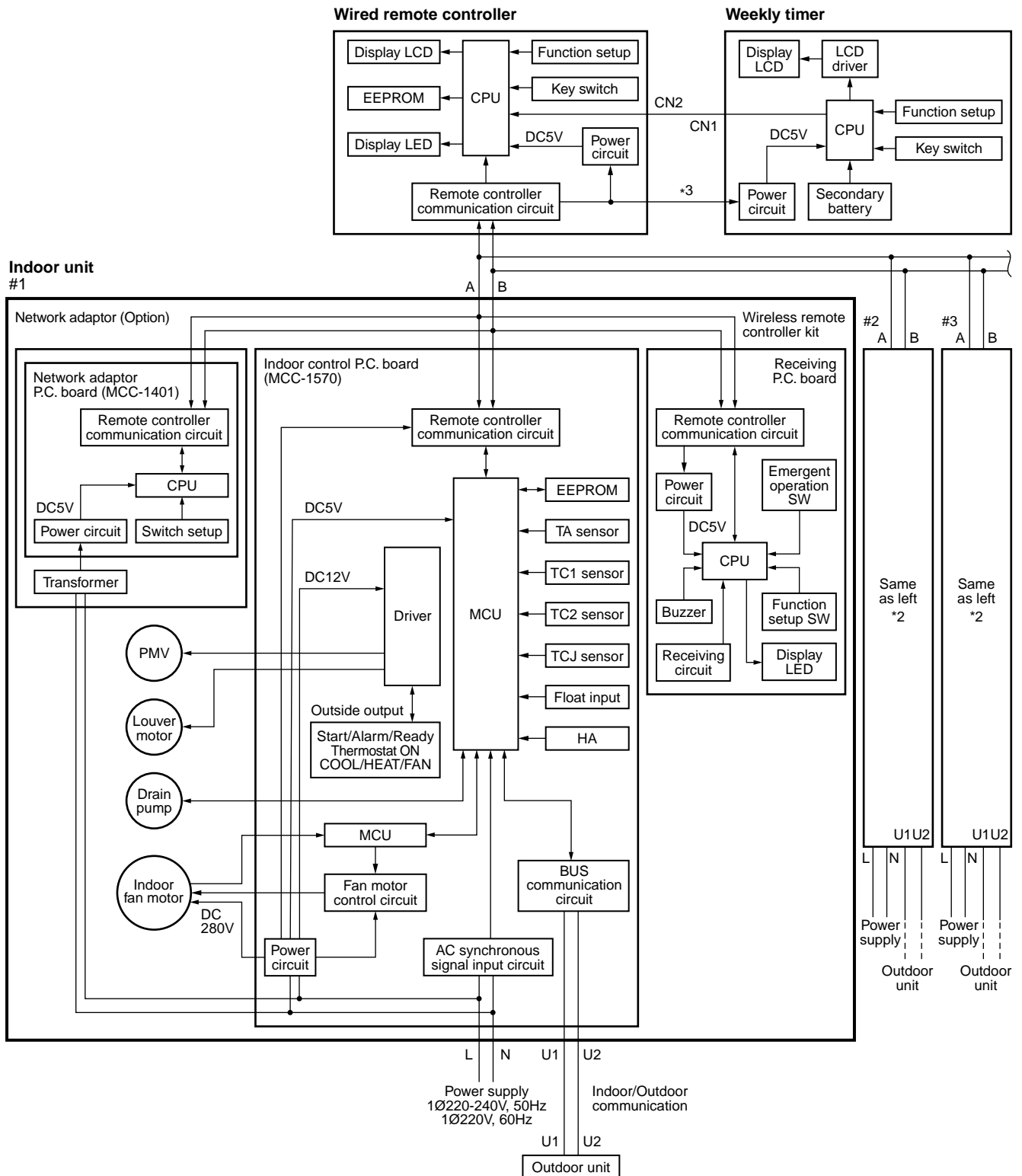

Max. 8 units are connectable. *1

*1 However in a case that the network adaptor is installed when 2 wireless remote controller kits are connected, maximum 7 units are connectable.

*2 The network adaptor is installed to only

*3 The weekly timer cannot be connected to the simple wired remote controller.

7-2. Indoor P.C. board
MCC-1570

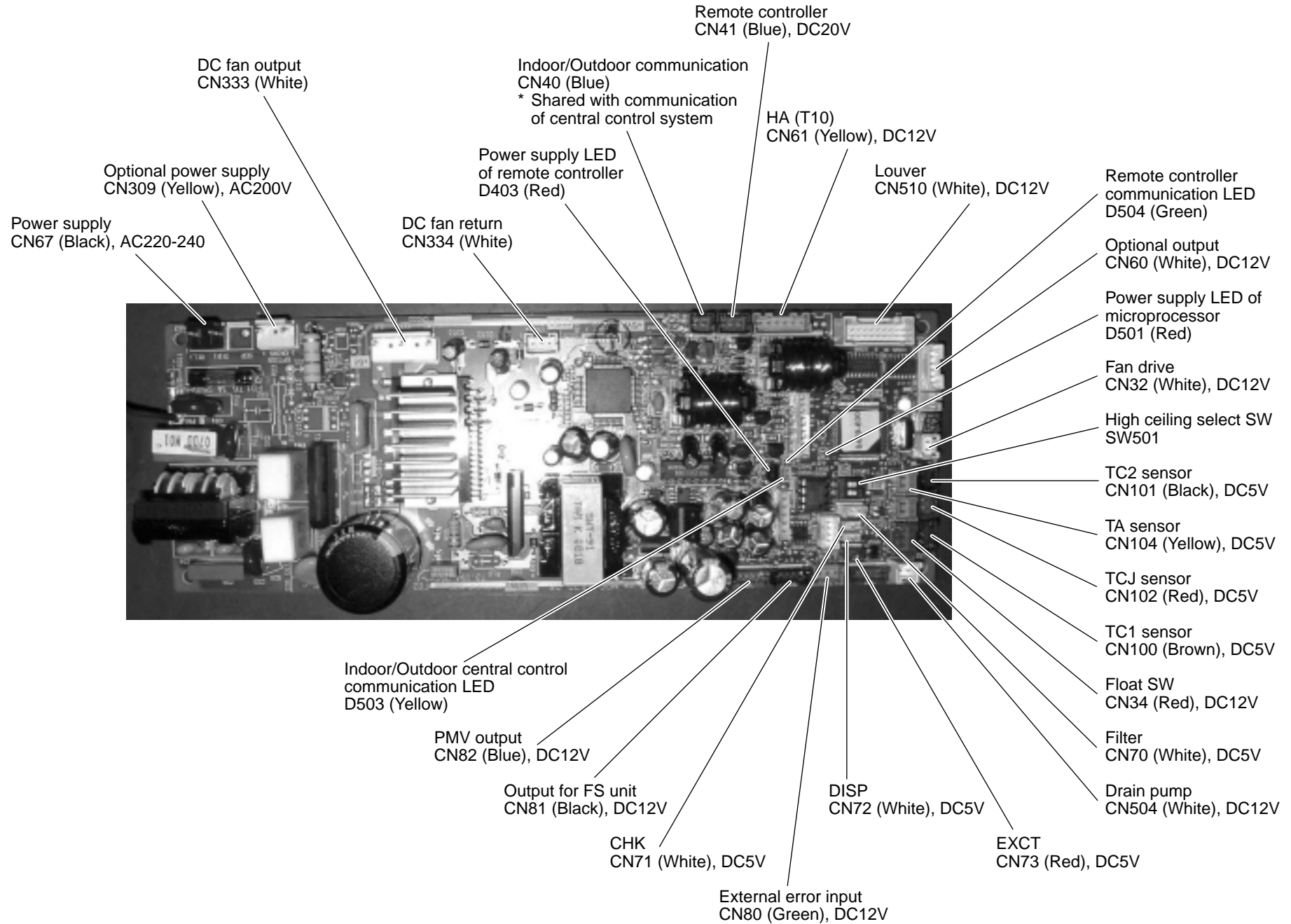

7-3. Functions at test run

■ Cooling/Heating test run check

The test run for cooling/heating can be performed from either indoor remote controller or outdoor interface P.C. board.

1. Start/Finish operation of test run

⊙ Test run from indoor remote controller

- └ Wired remote controller: Refer to the below item of "Test run" of the wired remote controller.
- └ Wireless remote controller: Refer to the next page item of "Test run" of the wireless remote controller.

◆ In case of wired remote controller

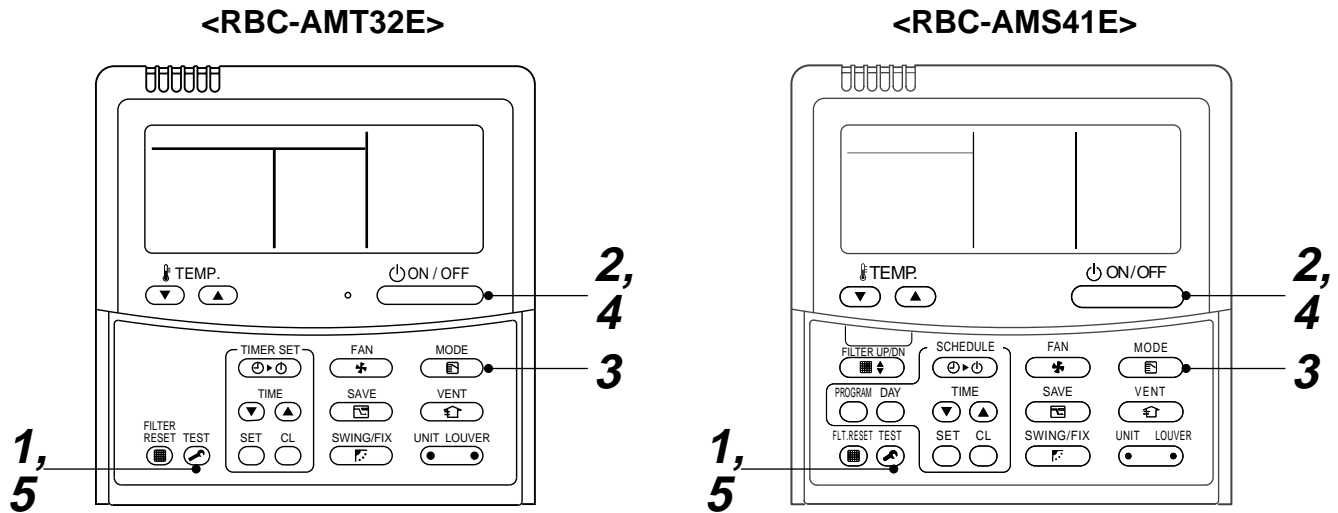

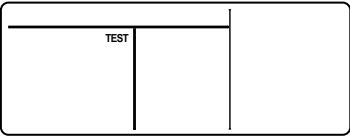
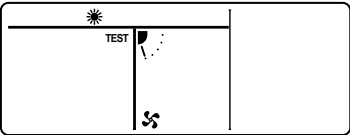
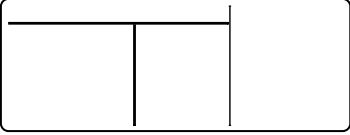
Procedure	Operation contents
1	<p>Push [TEST] button for 4 seconds or more. [TEST] is displayed at the display part and the mode enters in TEST mode.</p> 
2	<p>Push [ON/OFF] button.</p>
3	<p>Change the mode from [COOL] to [HEAT] using [MODE] button.</p> <ul style="list-style-type: none"> • Do not use [MODE] button for other mode except [COOL]/[HEAT] modes. • The temperature cannot be adjusted during test run. • The error detection is performed as usual. 
4	<p>After test run, push [ON/OFF] button to stop the operation. (Display on the display part is same to that in Procedure 1.)</p>
5	<p>Push [TEST] button to clear the TEST mode. ([TEST] display in the display part disappears and status becomes the normal stop status.)</p> 

Note) The test run returns to the normal operation after 60 minutes.

◆ In case of wireless remote controller

Procedure	Operation contents	
1	Push [ON/OFF] button on the remote controller. Change the operation mode to [COOL] or [HEAT] using [MODE] button and then select the air speed [H] using [FAN].	
2	Test run for cooling operation	Test run for heating operation
	Set [18°C] using [Temperature set] button.	Set [30°C] using [Temperature set] button.
3	Set [19°C] using [Temperature set] button immediately after confirmation of the receiving sound "Pi".	Set [29°C] using [Temperature set] button immediately after confirmation of the receiving sound "Pi".
4	Set [18°C] using [Temperature set] button immediately after confirmation of the receiving sound "Pi".	Set [30°C] using [Temperature set] button immediately after confirmation of the receiving sound "Pi".
5	Next carry out the procedures 3 → 4 → 3 → 4 . After approx. 10 seconds, all the indication lamps on the receiving part of the wireless remote controller [ON], [TIMER] and [Ready] flash and start the operation. Repeat operation of procedure 2 and after if the lamps do not flash.	
6	After the test run, push [ON/OFF] button to stop the operation.	

<Outline of test run from wireless remote controller>

Test run for cooling operation:

ON/OFF → 18°C → 19°C → 18°C → 19°C → 18°C → 19°C → 18°C → (Test run) → ON/OFF

Test run for heating operation:

ON/OFF → 30°C → 29°C → 30°C → 29°C → 30°C → 29°C → 30°C → (Test run) → ON/OFF

Note) The test run returns to the normal operation after 60 minutes.

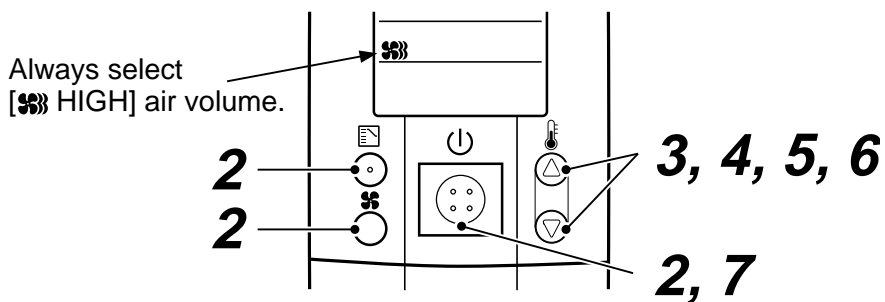

■ Check function for operation of indoor unit (Functions at indoor unit side)

This function is provided to check the operation of the indoor unit singly without communication with the remote controller or the outdoor unit. This function can be used regardless of operation or stop of the system.

However, if using this function for a long time, a trouble of the equipment may be caused. Limit using this function within several minutes.

[How to operate]

- 1) Short-circuit CHK pin (CN71 on the indoor P.C. board).

The operation mode differs according to the indoor unit status in that time.

Normal time: Both float SW and fan motor are normal.

Abnormal time: Either one of float SW or fan motor is abnormal.

- 2) Restricted to the normal time, if short-circuiting DISP pin (CN72 on the indoor P.C. board) in addition to short-circuit of CHK pin (CN71 on the indoor P.C. board), the minimum opening degree (30pls) can be set to the indoor PMV only.

When open DISP pin, the maximum opening degree (1500pls) can be obtained again.

[How to clear]

Open CHK pin. While the system is operating, it stops once but automatically returns to operation after several minutes.

	Short-circuit of CHK pin		
	Normal time		Abnormal time
	DISP pin open	DISP pin short circuit	
Fan motor	(H)	(H)	Stop
Indoor PMV (*)	Max. opening degree (1500pls)	Min. opening degree (30pls)	Min. opening degree (30pls)
Louver	Horizontal	Horizontal	Immediate stop
Drain pump	ON	ON	ON
Communication	All ignored	All ignored	All ignored
P.C. board LED	Lights	Lights	Flashes

- To exchange the indoor PMV coil, set the indoor PMV to Max. opening degree.
- For the detailed positions of CHK pin (CN71 on indoor P.C. board) and DISP pin (CN72 on indoor P.C. board), refer to the indoor P.C. board MCC-1570.

7-4. Optional Connector Specifications of Indoor P.C. Board

Function	Connector No.	Pin No.	Specifications	Remarks
—	CN66	—	—	—
Fan output	CN32	①	DC12V	Shipment setup: ON with indoor unit operation and OFF with stop are linked. * Single operation by FAN button on remote controller is set up from remote controller (DN=31)
		②	Output	
HA	CN61	①	ON/OFF input	HA ON/OFF input (J01: YES/NO=Pulse (At shipment) / Static input select)
		②	0V (COM)	
		③	Main prohibition input	Operation stop of main remote controller is permitted / prohibited by input.
		④	Operation output	ON during operation (Answerback of HA)
		⑤	DC12V (COM)	
		⑥	Alarm output	ON during alarm output
Option output	CN60	①	DC12V (COM)	
		②	Defrost output	ON when outdoor unit is defrosted
		③	Thermo ON output	ON during Real thermostat ON (Compressor ON)
		④	COOL output	ON when operation mode is cooling system (COOL, DRY, Cool/Heat Auto cooling)
		⑤	HEAT output	ON when operation mode is heating system (HEAT, Cool/Heat Auto cooling)
		⑥	Fan output	ON when indoor fan is ON (During use of air cleaner/Interlock cabling)
Outside error input	CN80	①	DC12V (COM)	Generate check code "L30" (for 1 minute continuously) to stop forcedly the operation.
		②	DC12V (COM)	
		③	Outside error input	
—	CN20	—	—	—
—	CN70	—	—	—
CHK operation check	CN71	①	Check mode input	Used for indoor operation check. (Outdoor does not communicate with remote controller, and outputs specified operation such as indoor fan "H", drain pump ON, etc.)
		②	0V	
DISP exhibition mode	CN72	①	Display mode input	Exhibition mode enables to communicate by indoor unit and remote controller only. (When power has been turned on.) Timer short (Usual)
		②	0V	
EXCT demand	CN73	①	Demand input	Indoor unit forced thermostat OFF operation
		②	0V	

8. APPLIED CONTROL

8-1. Setup of Selecting Function in Indoor Unit (Be Sure to Execute Setup by a Wired Remote Controller)

<Procedure> Execute the setup operation while the unit stops.

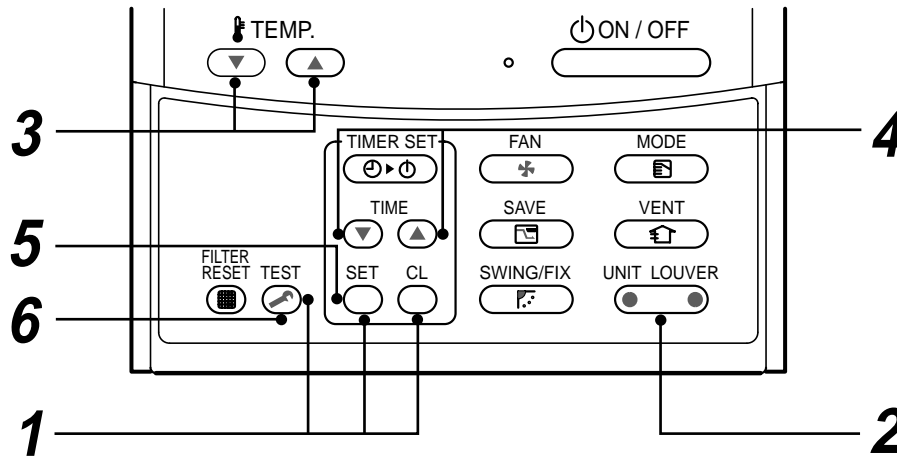

- 1** Push , , and buttons simultaneously for 4 seconds or more.
The firstly displayed unit No. indicates the header indoor unit address in the group control.
In this time, the fan of the selected indoor unit is turned on.
- 2** Every pushing button, the indoor unit numbers in the group control are successively displayed. In this time, the fan of the selected indoor unit only is turned on.
- 3** Specify the item code (DN) using the setup temperature and buttons.
- 4** Select the setup data using the timer time and buttons.
(When selecting the DN code to “33”, change the temperature indication of the unit from “°C” to “°F” on the remote controller.)
- 5** Push button. (OK if display goes on.)
 - To change the selected indoor unit, return to procedure **2**.
 - To change the item to be set up, return to procedure **3**.
- 6** Pushing button returns the status to normal stop status.

Table: Function selecting item numbers (DN)
(Items necessary to perform the applied control at the local site are described.)

DN	Item	Description	At shipment
01	Filter display delay timer	0000 : None 0002 : 2500H 0004 : 10000H 0001 : 150H 0003 : 5000H	0002 : 2500H
02	Dirty state of filter	0000 : Standard 0001 : High degree of dirt (Half of standard time)	0000 : Standard
03	Central control address	0001 : No.1 unit to 0064 : No.64 unit 0099 : Unfixed	0099 : Unfixed
04	Specific indoor unit priority	0000 : No priority 0001 : Priority	0000 : No priority
06	Heating temp shift	0000 : No shift to 0001 : +1°C 0002 : +2°C to 0010 : +10°C (Up to +6 recommended)	0002 : +2°C (Floor type 0000: 0°C)
0d	Existence of [AUTO] mode	0000 : Provided 0001 : Not provided (Automatic selection from connected outdoor unit)	0001 : Not provided
0F	Cooling only	0000 : Heat pump 0001 : Cooling only (No display of [AUTO] [HEAT])	0000 : Heat pump
10	Type	0001: 4-way Air Discharge Cassette	Depending on model type
11	Indoor unit capacity	0000 : Unfixed 0001 to 0034	According to capacity type
12	Line address	0001 : No.1 unit to 0030 : No.30 unit	0099 : Unfixed
13	Indoor unit address	0001 : No.1 unit to 0064 : No.64 unit	0099 : Unfixed
14	Group address	0000 : Individual 0002 : Follower unit of group 0001 : Header unit of group	0099 : Unfixed
19	Louver type (Air direction adjustment)	0000: No louver 0001: Swing only 0002: (1-way Air Discharge Cassette type, Under Ceiling type) 0003: (2-way Air Discharge Cassette type) 0004: (4-way Air Discharge Cassette type)	According to type
1E	Temp difference of [AUTO] mode selection COOL → HEAT, HEAT → COOL	0000 : 0 deg to 0010 : 10 deg (For setup temperature, reversal of COOL/HEAT by ± (Data value)/2)	0003 : 3 deg (Ts±1.5)
28	Automatic restart of power failure	0000 : None 0001 : Restart	0000 : None
2A	Selection of option/error input (CN70)	0000 : Filter input 0002 : None 0001 : Alarm input (Air washer, etc.)	0002 : None
2E	HA terminal (CN61) select	0000 : Usual 0002 : Fire alarm input 0001 : Leaving-ON prevention control	0000 : Usual (HA terminal)
31	Ventilating fan control	0000 : Unavailable 0001 : Available	0000 : Unavailable
32	TA sensor selection	0000 : Body TA sensor 0001 : Remote controller sensor	0000 : Body TA sensor
33	Temperature unit select	0000 : °C (at factory shipment) 0001 : °F	0000 : °C
F0	Swing mode	0001 : Standard 0003 : Cycle swing 0002 : Dual swing	0001: Standard
F1	Louver fixed position (Louver No.1)	0000 : Release 0005 : Downward discharge position 0001 : Horizontal discharge position	0000: Not fixed
F2	Louver fixed position (Louver No.2)	0000 : Release 0005 : Downward discharge position 0001 : Horizontal discharge position	0000: Not fixed
F3	Louver fixed position (Louver No.3)	0000 : Release 0005 : Downward discharge position 0001 : Horizontal discharge position	0000: Not fixed
F4	Louver fixed position (Louver No.4)	0000 : Release 0005 : Downward discharge position 0001 : Horizontal discharge position	0000: Not fixed

DN	Item	Description							At shipment	
5d	High ceiling selection (Selection of air volume)		AP009, AP012			AP015, AP018			0000: Standard	
			Type							
			Discharge	4-way	3-way	2-way	4-way	3-way		2-way
		0000	Standard (At shipment)	2.7m	2.8m	3.0m	2.8m	3.2m		3.5m
		0001	High ceiling ①	—	—	—	3.2m	3.5m		3.8m
		0003	High ceiling ③	—	—	—	3.5m	3.8m		—
			Type	AP024 to AP030			AP036 to AP056			
			Discharge	4-way	3-way	2-way	4-way	3-way		2-way
		0000	Standard (At shipment)	3.0m	3.3m	3.6m	3.0m	3.3m		3.6m
		0001	High ceiling ①	3.3m	3.5m	3.8m	3.3m	3.5m		3.8m
0003	High ceiling ③	3.6m	3.8m	—	3.6m	3.8m	—			
	Built-in filter	0000: Standard filter (At shipment)								
60	Timer setup (Wired remote controller)	0000: Available (Operable) 0001: Unavailable (Operation prohibited)							0000: Available	

TYPE

Item code [10]

Setup data	Type	Abbreviated Model name
*1 0001	4-way Air Discharge Cassette	MMU-AP XXX H

*1: Initial setting value of EEPROM installed on the service P.C. board

Indoor unit capacity

Item code [11]

Setup data	Model	Setup data	Model
0003	009	0012	027
0005	012	0013	030
0007	015	0015	036
0009	018	0017	048
0011	024	0018	056

8-2. Applied Control in Indoor Unit

■ Remote location ON/OFF control box (TCB-IFCB-4E)

[Wiring and setup]

- Use the exclusive connector for connection with the indoor control P.C. board.
- In a group control, the system can operate when connecting with any indoor unit (Control P.C. board) in the group. However when taking out the operation/error signal from the other unit, it is necessary to take out from each unit individually.

1. Control items

- 1) Start/Stop input signal : Operation start/stop in unit
- 2) Operation signal : Output during normal operation
- 3) Error signal : Output during alarm
(Serial communication error or indoor/outdoor protective device) operation

2. Wiring diagram using remote control interface (TCB-IFCB-4E2)

Input IFCB-4E2 : No voltage ON/OFF serial signal
 Output No voltage contact for operation, error display
 Contact capacity: Below Max. AC240V 0.5A

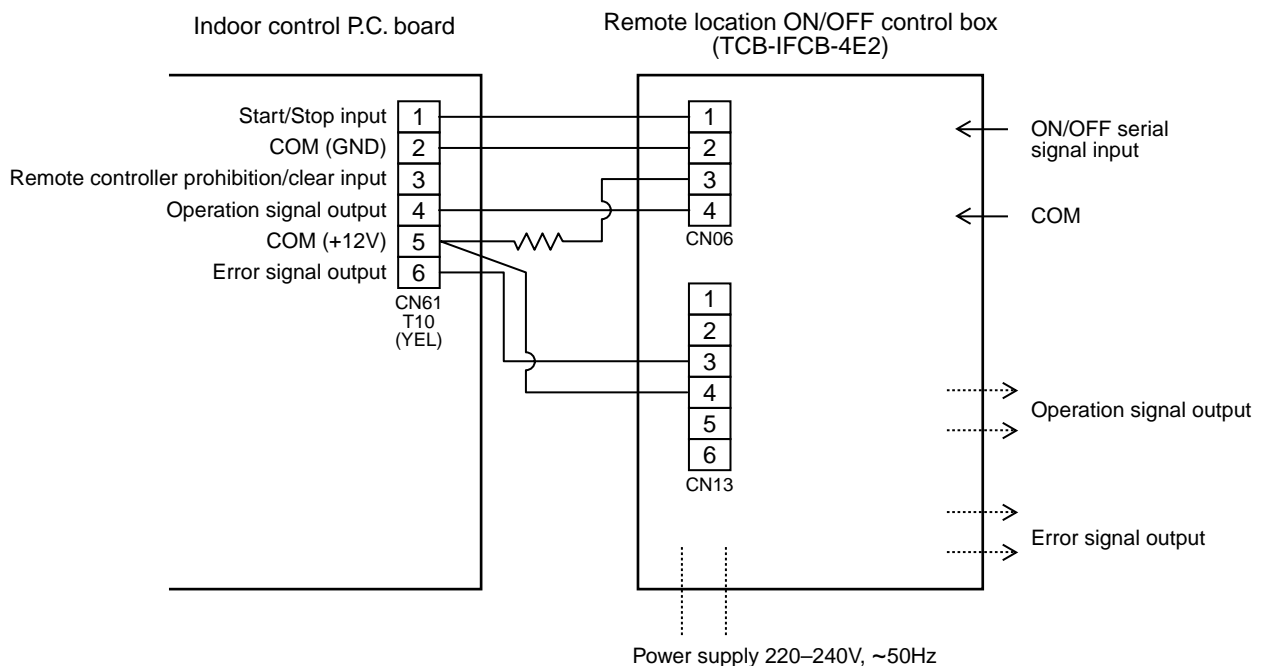

■ Ventilating fan control from remote controller

[Function]

- The start/stop operation can be operated from the wired remote controller when air to air heat exchanger or ventilating fan is installed in the system.
- The fan can be operated even if the indoor unit is not operating.
- Use a fan which can receive the no-voltage A contact as an outside input signal.
- In a group control, the units are collectively operated and they can not be individually operated.

1. Operation

Handle a wired remote controller in the following procedure.

- * Use the wired remote controller during stop of the system.
- * Be sure to set up the wired remote controller to the header unit. (Same in group control)
- * In a group control, if the wired remote controller is set up to the header unit, both header and follower units are simultaneously operable.

1 Push concurrently + + buttons for 4 seconds or more.

The unit No. displayed firstly indicates the header indoor unit address in the group control.

In this time, the fan of the selected indoor unit turns on.

2 Every pushing button, the indoor unit numbers in group control are displayed successively.

In this time, the fan of the selected indoor unit only turns on.

3 Using the setup temp or button, specify the item code 31 .

4 Using the timer time or button, select the setup data. (At shipment: 0000)

The setup data are as follows:

Setup data	Handling of operation of air to air heat exchanger or ventilating fan
0000	Unavailable (At shipment)
0001	Available

5 Push button. (OK if display goes on.)

- To change the selected indoor unit, go to the procedure 2).
- To change the item to be set up, go to the procedure 3).

6 Pushing returns the status to the usual stop status.

2. Wiring

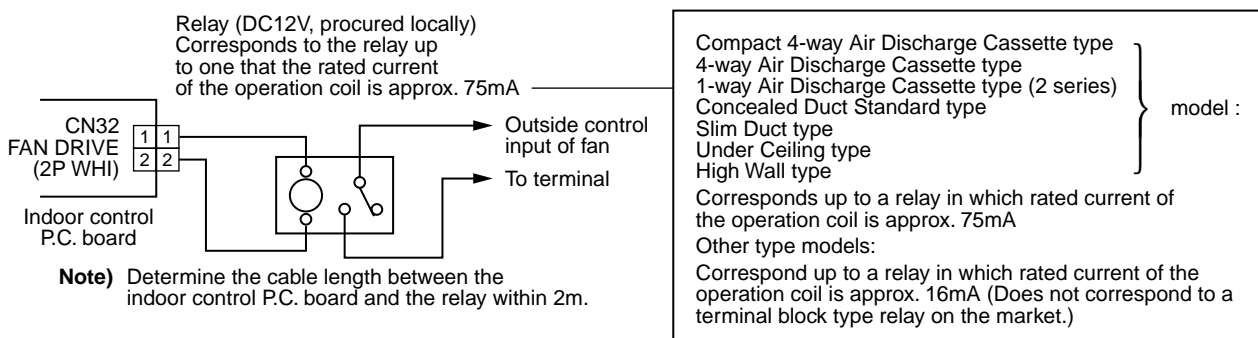

■ Leaving-ON prevention control

[Function]

- This function controls the indoor units individually. It is connected with cable to the control P.C. board of the indoor unit.
- In a group control, it is connected with cable to the indoor unit (Control P.C. board), and the item code 2E is set to the connected indoor unit.
- It is used when the start operation from outside if unnecessary but the stop operation is necessary.
- Using a card switch box, card lock, etc, the forgotten-OFF of the indoor unit can be protected.
- When inserting a card, start/stop operation from the remote controller is allowed.
- When taking out a card, the system stops if the indoor unit is operating and start/stop operation from the remote controller is forbidden.

1. Control items

- 1) Outside contact ON : The start/stop operation from the remote controller is allowed.
(Status that card is inserted in the card switch box)
- 2) Outside contact OFF : If the indoor unit is operating, it is stopped forcibly.
(Start/Stop prohibited to remote controller)
(Status that card is taken out from the card switch box)

* When the card switch box does not perform the above contact operation, convert it using a relay with b contact.

2. Operation

Handle the wired remote controller switch in the following procedure.

* Use the wired remote controller switch during stop of the system.

- 1 Push concurrently $\text{SET} + \text{CL} + \text{TEST}$ buttons for 4 seconds or more.**
- 2 Using the setup temp ▼ or ▲ button, specify the item code $2E$.**
- 3 Using the timer time ▼ or ▲ button, set 0001 to the setup data.**
- 4 Push SET button.**
- 5 Push TEST button. (The status returns to the usual stop status.)**

3. Wiring

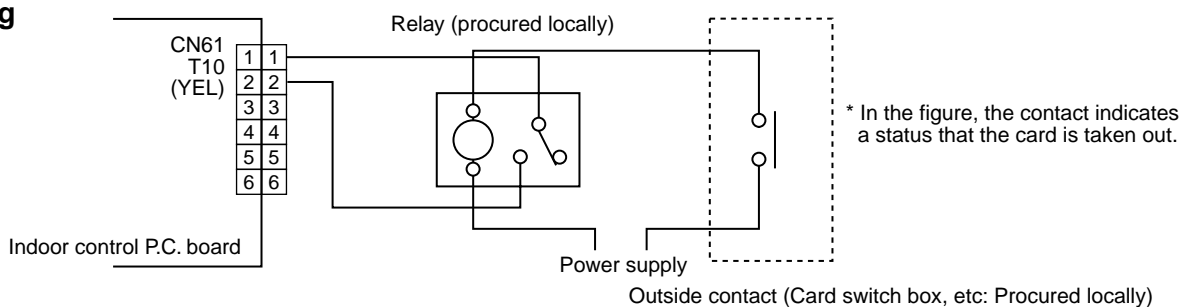

Note) Determine the cable length between the indoor control P.C. board and the relay within 2m.

■ Power peak-cut from indoor unit

When the relay is turned on, a forced thermostat-OFF operation starts.

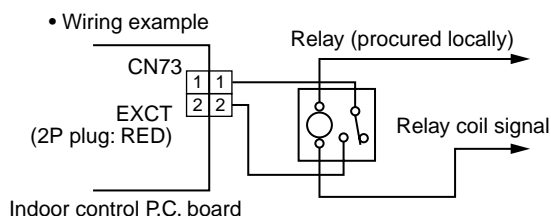

Note) Determine the cable length between the indoor or outdoor control P.C. board and the relay within 2m.

■ Address setup (Manual setting from remote controller)

In case that addresses of the indoor units will be determined prior to piping work after cabling work

- Set an indoor unit per a remote controller.
- Turn on power supply.

- 1** Push **SET** + **CL** + **TEST** buttons simultaneously for 4 seconds or more.
- 2** (Line address)
Using the temperature setup **▼** / **▲** buttons, set **1** to the item code.
- 3** Using timer time **▼** / **▲** buttons, set the line address.
- 4** Push **SET** button. (OK when display goes on.)
- 5** (Indoor unit address)
Using the temperature setup **▼** / **▲** buttons, set **1** to the item code.
- 6** Using timer time **▼** / **▲** buttons, set 1 to the line address.
- 7** Push **SET** button. (OK when display goes on.)
- 8** (Group address)
Using the temperature setup **▼** / **▲** buttons, set **1** to the item code.
- 9** Using timer time **▼** / **▲** buttons, set **0000** to Individual, **0001** to Master unit and **0002** to sub unit.
- 10** Push **SET** button. (OK when display goes on.)
- 11** Push **TEST** button.
Setup completes.
(The status returns to the usual stop status.)

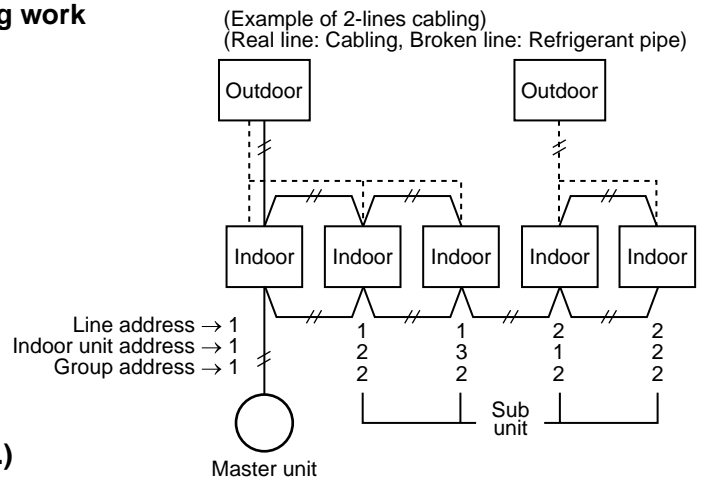

For the above example, perform setting by connecting singly the wired remote controller without remote controller inter-unit cable.

Group address
Individual : 0000
Master unit : 0001
Sub unit : 0002 } In case of group control

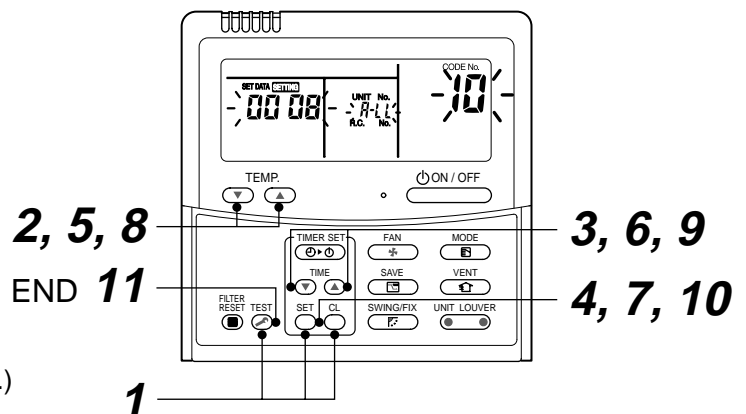

<Operation procedure>

**1 → 2 → 3 → 4 → 5 → 6 →
7 → 8 → 9 → 10 → 11 END**

Note 1)

When setting the line address from the remote controller, do not use Address 29 and 30.

As they are addresses which cannot be set to the outdoor unit, if they are set, the check code [E04] (Indoor/Outdoor communication circuit error) is issued.

Note 2)

When an address was manually set from the remote controller and the central control over the refrigerant lines is carried out, perform the following setting for the Master unit of each line.

- Set the line address for every line using SW13 and 14 on the interface P.C. board of the center unit in each line.
- Except the least line address No., turn off SW30-2 on the interface P.C. board of the Master units in the lines connected to the identical central control.
(Draw the terminal resistances of indoor/outdoor and central control line wirings together.)
- For each refrigerant line, connect the relay connector between Master unit [U1U2] and [U3U4] terminals.
- After then set the central control address.
(For setting of the central control address, refer to the Installation manual for the central control equipment.)

■ Confirmation of indoor unit No. position

1. To know the indoor unit addresses though position of the indoor unit is recognized

- In case of individual operation (Wired remote controller : indoor unit = 1 : 1)
(Follow to the procedure during operation)

<Procedure>

1 Push  button if the unit stops.

2 Push  button.

Unit No. 1-1 is displayed on LCD.

(It disappears after several seconds.)

The displayed unit No. indicate line address and indoor unit address.

(When other indoor units are connected to the identical remote controller (Group control unit), other unit numbers are also displayed every pushing  button.

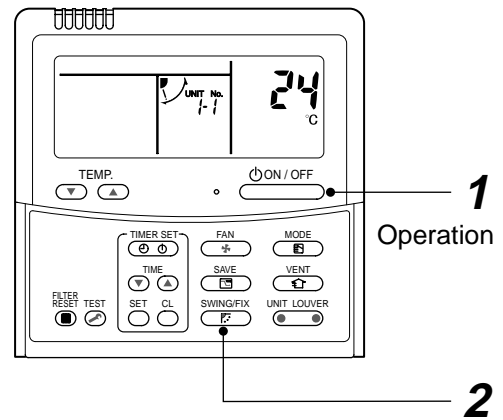

<Operation procedure>

1 → 2 END



2. To know the position of indoor unit by address

- To confirm the unit No. in the group control
(Follow to the procedure during operation) (in this procedure, the indoor units in group control stop.)

<Procedure>

The indoor unit numbers in the group control are successively displayed, and fan, louver, and drain pump of the corresponding indoor unit are turned on.

(Follow to the procedure during operation)

1 Push  and  buttons simultaneously for 4 seconds or more.

- Unit No. **ALL** is displayed.
- Fans and louvers of all the indoor units in the group control operate.

2 Every pushing  button, the unit numbers in the group control are successively displayed.

- The unit No. displayed at the first time indicates the master unit address.
- Fan and louver of the selected indoor unit only operate.

3 Push  button to finish the procedure.
All the indoor units in the group control stop.

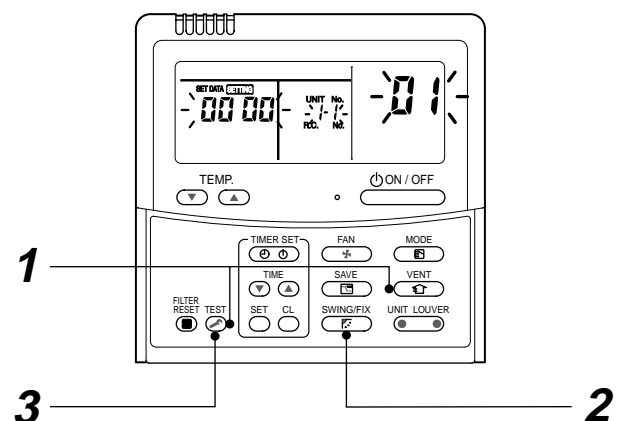

<Operation procedure>

1 → 2 → 3 END

■ Function selection setup

<Procedure> Perform setting while the air conditioner stops.

1 Push **TEST** + **SET** + **CL** buttons simultaneously for 4 seconds or more.

The first displayed unit No. is the master indoor unit address in the group control.
In this time, fan and louver of the selected indoor unit operate.



2 Every pushing **UNIT LOUVER** button (button at left side), the indoor unit No. in the group control is displayed one after the other.

In this time, fan and louver of the selected indoor unit only operate.



3 Using the set temperature **TEMP.** buttons, specify the item code (DN).



4 Using the timer time **TIME** buttons, select the set data.



5 Push **SET** button. (OK if indication lights)

- To change the selected indoor unit, proceed to Procedure **2**.
- To change item to be set up, proceed to Procedure **3**.



6 Pushing **TEST** button returns the status to the normal stop status.

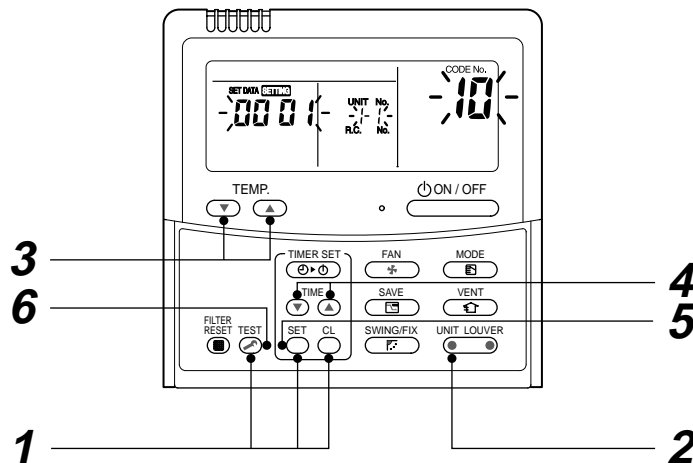

<Operation procedure>

1 → 2 → 3 → 4 → 5 → 6 END

■ How to check all the unit No. from an arbitrary wired remote controller

<Procedure> Carry out this procedure during stop of system.

The indoor unit No. and the position in the identical refrigerant piping can be checked.

An outdoor unit is selected, the identical refrigerant piping and the indoor unit No. are displayed one after the other, and then its fan and louver are on.

- 1 Push the timer time button + simultaneously for 4 seconds or more.
First line 1 and item code **AL** (Address Change) are displayed. (Select outdoor unit.)



- 2 Select line address using / button.



- 3 Determine the selected line address using button.

- The address of the indoor unit connected to the refrigerant piping of the selected outdoor unit is displayed and the fan and the louver are on.



- 4 Every pushing button, the indoor unit No. in the identical piping is displayed one after the other.

- Only fan and louver of the selected indoor unit start operation.

[To select the other line address]

- 5 Push button and the operation returns to Procedure 2.

- * The indoor address of other line can be continuously checked.



- 6 Push button and then the procedure finishes.

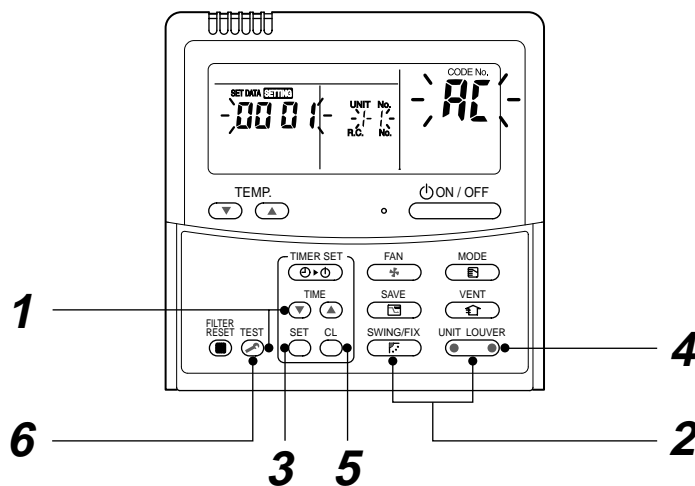

<Operation procedure>

1 → 2 → 3 → 4 → 5 → 6 END

■ How to change all indoor addresses from an arbitrary wired remote controller

(It is possible when setting has finished by automatic addresses.)

Contents: The indoor unit addresses in each identical refrigerant piping line can be changed from an arbitrary wired remote controller.

⊙ Enter in address check/change mode and then change the address.

<Procedure> Carry out this procedure during stop of system.

- 1 Push the timer time button + simultaneously for 4 seconds or more. First line 1 and item code *AC* (Address Change) are displayed.



- 2 Select line address using / button.



- 3 Push the button.
 - The address of the indoor unit connected to the refrigerant piping of the selected outdoor unit is displayed and the fan and the louver are on. First the current indoor address is displayed. (Line address is not displayed.)



- 4 button push up/down the indoor address of the SET DATA. The set data is changed to a new address.



- 5 Push button to determine the set data.



- 6 Every pushing button, the indoor unit No. in the identical piping is displayed one after the other.
 - Only fan and louver of the selected indoor unit start operation. Repeat the Procedures 4 to 6 to change all the indoor addresses so that they are not duplicated.



- 7 Push button. (All the indications of LCD go on.)



- 8 Push button and then the procedure finishes.

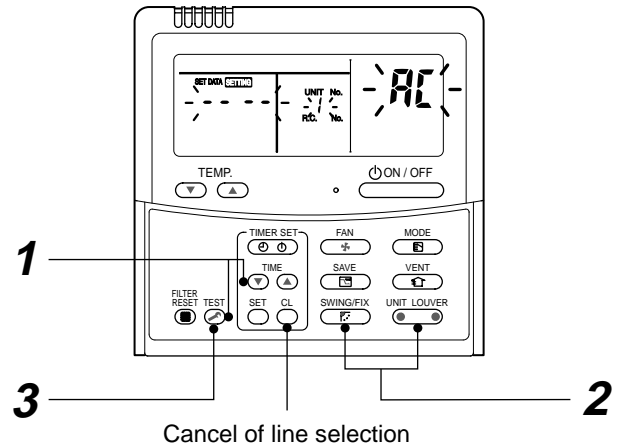

If the UNIT No. is not call up here, the outdoor unit in that line does not exist.

Push button to select a line again in the Procedure 2.

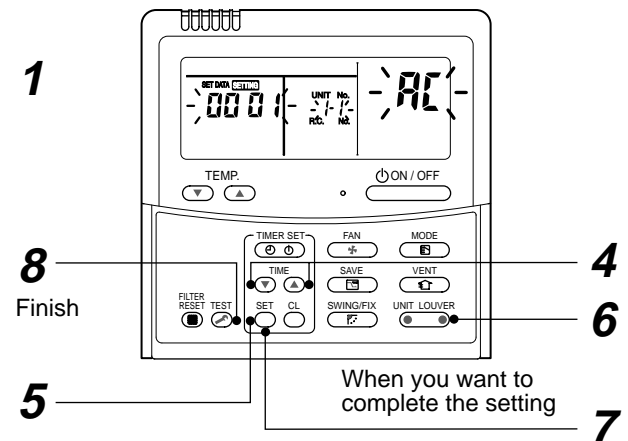

<Operation procedure>

1 → 2 → 3 → 4 → 5 →
6 → 7 → 8 END

■ Function to clear error

1. Clearing method from remote controller

⊙ How to clear error of outdoor unit

In the unit of refrigerant line connected by indoor unit of the remote controller to be operated, the error of the outdoor unit currently detected is cleared. (Error of the indoor unit is not cleared.)

The service monitor function of the remote controller is utilized.

<Method>

- 1** Push **CL** + **TEST** buttons simultaneously for 4 seconds or more to change the mode to service monitor mode.
- 2** Push **TEMP.** button to set the item code to [FF].
- 3** The display of A part in the following figure is counted as “0005” → “0004” → “0003” → “0002” → “0001” → “0000” with 5-seconds interval.
When “0000” appear, the error was cleared.
* However counting from “0005” is repeated on the display screen.
- 4** When pushing **TEST** button, the status becomes normal.

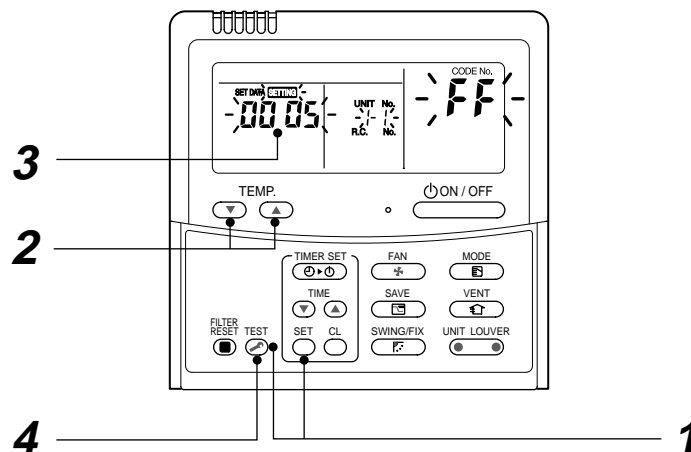

<Operation procedure>

1 → 2 → 3 → 4

Returns to normal status

⊙ How to clear error of indoor unit

The error of indoor unit is cleared by **ON/OFF** button of the remote controller.

(Only error of the indoor unit connected with remote controller to be operated is cleared.)

■ Monitoring function of remote controller switch

When using the remote controller (Model Name: RBC-AMT32E), the following monitoring function can be utilized.

Calling of display

<Contents>

The temperature of each sensor of the remote controller, indoor unit and outdoor unit and the operating status can be checked by calling the service monitor mode from the remote controller.

<Procedure>

- 1 Push **TEST** + **CL** buttons simultaneously for 4 seconds or more to call up the service monitor mode. The service monitor goes on and firstly the temperature of the CODE No. **00** is displayed.



- 2 Push **TEMP.** button to change CODE No. (CODE No.) to the CODE No. to be monitored. For display code, refer to the following table.



- 3 Push **UNIT LOUVER** button to change to item to be monitored.

The sensor temperature of indoor unit or outdoor unit in its refrigerant line and the operating status are monitored.



- 4 Push **TEST** button to return the status to the normal display.

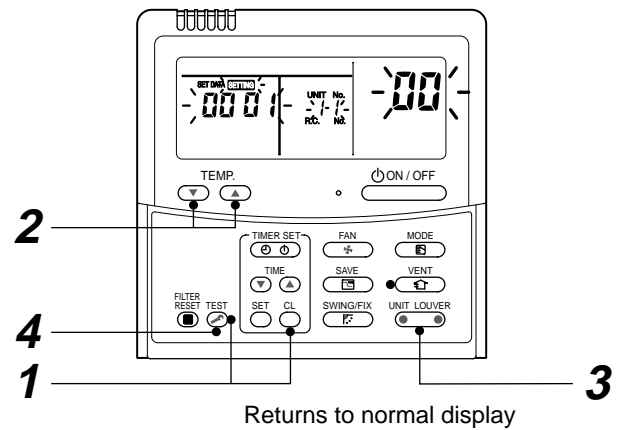

<Operation procedure>

1 → 2 → 3 → 4

	CODE No.	Data name	Unit	Display form	CODE No.	Data name	Unit	Display form	
Indoor unit data	00	Room temp. (Under control) (Note 1)	°C	x 1	Individual outdoor unit data (Note 3, 4)	10	Compressor 1 discharge temp. (Td1)	°C	x 1
	01	Room temp. (Remote controller)	°C	x 1		11	Compressor 2 discharge temp. (Td2)	°C	x 1
	02	Indoor suction temp. (TA)	°C	x 1		12	High pressure sensor detection pressure (Pd)	MPa	x 100
	03	Indoor coil temp. (TCJ)	°C	x 1		13	Low pressure sensor detection pressure (Ps)	MPa	x 100
	04	Indoor coil temp. (TC2)	°C	x 1		14	Suction temp. (TS)	°C	x 1
	05	Indoor coil temp. (TC1)	°C	x 1		15	Outdoor coil temp. (TE)	°C	x 1
	08	Indoor PMV opening degree	pls	x 1/10		16	Liquid side temp. (TL)	°C	x 1
	F2	Indoor fan accumulated operation time	h	x 100		17	Outside temp. (TO)	°C	x 1
	F3	Filter sign time	h	x 1		18	Low pressure saturation temp. (TU)	°C	x 1
System data	0A	No. of connected indoor units	unit			19	Compressor 1 current (I1)	A	x 10
	0B	Total HP of connected indoor units	HP	x 10		1A	Compressor 2 current (I2)	A	x 10
	0C	No. of connected outdoor units	unit			1B	PMV1 + 2 opening degree	pls	x 1/10
	0D	Total HP of connected outdoor units	HP	x 10		1D	Compressor 1, 2 ON/OFF	—	(Note 2)
						1E	Outdoor fan mode	—	0 to 31
				1F		Outdoor unit HP	HP	x 1	

(Note 1) In the group connection, only data of the header indoor unit is displayed.

(Note 2) 01: Only compressor 1 is ON.
10: Only compressor 2 is ON.
11: Both compressor 1 and 2 are ON.

(Note 3) For the CODE No., an example of header unit is described.

(Note 4) Upper girder of CODE No. indicates the outdoor unit No.

1: Header unit (A)
2: Follower unit (B)
3: Follower unit (C)
4: Follower unit (D)

■ LED display on P.C. board

1. D501 (Red)

- D501 goes on at the same time when the power supply is turned on.
(Goes on with operation of the main microprocessor)
- D501 flashes with 1-second interval (every 0.5 second) : When there is no EEPROM or write-in error
- D501 flashes with 10-seconds interval (every 5 second) : In DISP mode
- D501 flashes with 2-seconds interval (every 1 second) : During setting of function exchange
(EEPROM)

2. D403 (Red)

- D403 goes on when power is supplied to the remote controller. (ON in hardware)

3. D503 (Yellow): Indoor/Outdoor central control

- D503 goes on for 5 seconds at the first half during communication with the central controller.
- D503 flashes for 5 seconds with 0.2-second interval at the latter half during communication with outdoor unit. (Goes on for 0.1 second, goes off for 0.1 second)

4. D504 (Green): Remote controller communication

- D504 goes on for 5 seconds at the first half during communication with remote controller.
(Header unit of group)
- In the group indoor unit, D504 flashes for 5 seconds with 0.2-second interval at the latter half during communication between header and follower unit. (Goes on for 0.1 second, goes off for 0.1 second)

9. TROUBLESHOOTING

9-1. Troubleshooting Summary

1. Before troubleshooting

1) Applied models

① S-MMS Multi type models

Indoor unit : MMX-APXXX,

Outdoor unit : MMY-MAPXXXXT8X, MMY-MAPXXXHT7X

② Super Heat Recovery Multi type models

Indoor unit : MMX-APXXX,

Outdoor unit : MMY-MAPXXXFT8X

③ Mini-S-MMS Multi type models

Indoor unit : MMX-APXXX,

Outdoor unit : MCY-MAPXXXHT, MCY-MAPXXXHT2X

2) Required tools / measuring devices

- Screwdrivers (Philips, Minus), spanner, radio pinchers, nipper, push pin for reset switch, etc.
- Tester, thermometer, pressure gauge, etc.

3) Confirmation before check (The following items are not troubles.)

No.	Operation	Check items
1	Compressor does not operate.	<ul style="list-style-type: none"> • Is not delayed for 3 minutes? (3 minutes after compressor-OFF) • Is not thermostat OFF? • Is not the fan operating or timer? • Is not the system initially communicating? Heating operation cannot be performed under condition of outside temperature 21°C or higher. Cooling operation cannot be performed under condition of outside temperature -5°C or lower.
2	Indoor fan does not work.	<ul style="list-style-type: none"> • Is not the cold draft prevention being controlled in heating operation?
3	Outdoor fan does not rotate, or fan speed changes.	<ul style="list-style-type: none"> • Is not low cooling operation being controlled? • Is not a defrost operation being performed?
4	Indoor fan does not stop.	<ul style="list-style-type: none"> • Is not after-heat elimination operation being controlled after heating operation?
5	Start/stop operation on remote controller is unavailable.	<ul style="list-style-type: none"> • Is not auxiliary unit or remote control being operated?
6	—	<ul style="list-style-type: none"> • Is connecting wire of indoor unit or remote controller correct?

2. Troubleshooting procedure

When a trouble occurred, advance the check operation in the following procedure.

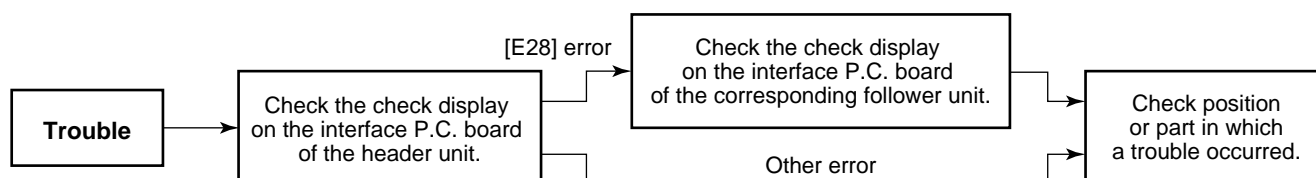

NOTE

While a check operation is performed, a malfunction of the microprocessor may be caused due to condition of the power supply or the external noise.

If there is any noise source, change wires of the remote controller and signal wires to shield wires.

9-2. How to check

On the remote controller (Remote controller, Central control remote controller) and on the interface P.C. board of the outdoor unit, LCD display part (Remote controller) or 7-segment display part (on outdoor interface P.C. board) is provided in order to display the operation status.

When a trouble occurred, the method to judge the trouble or defective position of the air conditioner by this self-diagnosis function is shown below.

The following table shows the list of each check code that each device detects. Check the check contents in the following table according to position to be checked.

- Check from the indoor remote controller or TCC-LINK central controller: Refer to “Display on remote controller & TCC-LINK central controller” in the following table.
- Check from outdoor unit: Refer to “Display of outdoor segment” in the following table.
- Check from indoor unit of wireless remote controller: Refer to Sensor lamp display” in the following table.

Check code display list (Indoor unit)

(*) O: Goes on, @: Flashes, ●: Goes off
 A (Alternate) : Flashing condition is alternate when there are two flashing LED.
 S (Simultaneously) : Two LED flash simultaneously when there are two flashing LED.

[Indoor unit detects error.]

Check code display			Sensor lamp display				Main defective position	Description	
TCC-LINK central & remote controller	AI-NET central (Network adapter use)	Outdoor 7-segment		Block display (*)					
		Auxiliary code		Operation	Timer	Ready			Flash
E03	97	—	—	@	●	●	—	Regular communication error between indoor and remote controller	No communication from remote controller and network adapter (No central control system communication also)
E04	04	—	—	●	●	@	—	Regular communication error between indoor and outdoor	No communication from outdoor unit
E08	96	E08	Duplicated indoor unit No.	@	●	●	—	Duplicated indoor address	An address same to self address was detected.
E10	CF	—	—	@	●	●	—	Communication error between indoor MCU	Communication error between MCU of main motor microprocessors
E18	97, 99	—	—	@	●	●	—	Regular communication error between header and follower in indoor unit	Regular communication between header and follower units in indoor unit was impossible.
F01	OF	—	—	@	@	●	A	Indoor heat exchanger temp. sensor (TCJ) error	Open/short of heat exchanger temp. sensor (TCJ) was detected.
F02	Od	—	—	@	@	●	A	Indoor heat exchanger temp. sensor (TC2) error	Open/short of heat exchanger temp. sensor (TC2) was detected.
F03	93	—	—	@	@	●	A	Indoor heat exchanger temp. sensor (TC1) error	Open/short of heat exchanger temp. sensor (TC1) was detected.
F10	OC	—	—	@	@	●	A	Room tem. Sensor (TA) error	Open/short of room temp. sensor (TA) was detected.
F29	12	—	—	@	@	●	S	Indoor or other P.C. board error	Indoor EEPROM error (Other error may be detected.)
L03	96	—	—	@	●	@	S	Duplicated setting of header in indoor group	There were multiple header units in a group.
L07	99	—	—	@	●	@	S	There is group cable in individual indoor unit.	There is even an indoor unit connected to group in individual indoor unit.
L08	99	L08	—	@	●	@	S	Indoor group address is unset.	Indoor group address is unset. (Detected also at outdoor unit side)
L09	46	—	—	@	●	@	S	Indoor capacity is unset.	Capacity of indoor unit is unset.
L20	98	—	—	@	○	@	S	Duplicated central control system address	Setting of central control system address is duplicated.
L30	b6	L30	Detected indoor unit No.	@	○	@	S	External error was input in indoor (Interlock).	System abnormally stopped by input of external error (CN80).
P01	11	—	—	●	@	@	A	Indoor AC fan error	Error of indoor AC fan was detected. (Fan motor thermal relay operation)
P10	Ob	P10	Detected indoor unit No.	●	@	@	A	Indoor overflow was detected.	Float switch operated.
P12	11	—	—	●	@	@	A	Indoor DC fan error	Error (Over-current, lock, etc.) of indoor DC fan was detected.
P31	47	—	—	@	●	@	A	Other indoor unit error	Group follower unit cannot be operated by [E03/L03/L07/L08] alarm of header unit.

Note) The check code display may be different according to the detected device even same error contents such as communication error.

[Remote controller detects error.]

(*) O: Goes on, ◎: Flashes, ●: Goes off
 A (Alternate) : Flashing condition is alternate when there are two flashing LED.
 S (Simultaneously) : Two LED flash simultaneously when there are two flashing LED.

Check code display			Sensor lamp display				Main defective position	Description
Remote controller	AI-NET central (Network adapter use)	Outdoor 7-segment	Block display (*)					
		Auxiliary code	Operation	Timer	Ready	Flash		
E01	97	— —	◎	●	●		No remote controller header unit, remote controller communication (receive) error	When signal cannot be received from indoor unit, when header of remote controller was not set (including 2 remote controllers)
E02	—	— —	◎	●	●		Remote controller communication (send) error	When signal cannot be sent to indoor unit
E09	99	— —	◎	●	●		Duplicated remote controller header	In 2-remote controller control, both remote controllers were set to header. (Indoor header stops with alarm and follower unit continues operation.)

[Central controller detects error.]

Check code display			Sensor lamp display				Main defective position	Description
TCC-LINK central	AI-NET central (Network adapter use)	Outdoor 7-segment	Block display (*)					
		Auxiliary code	Operation	Timer	Ready	Flash		
C05	98	— —	Is not displayed (In shared use of remote controller)				Central control system communication (send) error	When signal of central control system cannot be sent, there are same multiple central devices (AI-NET)
C06	97	— —					Central control system communication (receive) error	When signal of central control system cannot be received
—	99	— —					There are multiple network adapters.	There were multiple network adapters (AI-NET) on remote controller communication line.
C12	23	— —	—				Batched alarm of interface for general-purpose equipment control	Error of equipment connected to control interface of the general-purpose unit exclusive to TCC-LINK/AI-NET
P30	b7	— —	According to unit with alarm (Abovementioned)				Group follower unit error	Group follower unit error (For remote controller, [***] details is displayed together with unit No.)

Note) The check code display may be different according to the detected device even same error contents such as communication error.

Check code display list (Outdoor unit)

(*) O: Goes on, @: Flashes, ●: Goes off

A (Alternate) : Flashing condition is alternate when there are two flashing LED.

S (Simultaneously) : Two LED flash simultaneously when there are two flashing LED.

(S-MMS standard & accumulating outdoor interface detect: Representative example)

Check code display			Sensor lamp display				Main defective position	Description	
Outdoor 7-segment	TCC-LINK central & remote controller	AI-NET central (Network adapter use)	Block display (*)						
Auxiliary code			Operation	Timer	Ready	Flash			
E06	No. of indoor units with normal receiving	E06	04	●	●	@		Decrease of No. of indoor units	When signal did not come from indoor unit (Decrease of connected indoor units)
E07	—	(E04)	(97, 99)	●	●	@		Indoor/Outdoor communication circuit error	When signal could not send to indoor unit (→ Status that there is no communication to indoor unit from outdoor unit)
E08	Duplicated indoor unit No.	(E08)	(96)	@	●	●		Duplicated indoor address	When there were multiple indoor units with same address (Detected at indoor unit side also)
E12	01: Communication between indoor and outdoor 02: Communication between outdoor units	E12	42	@	●	●		Automatic address start error	When automatic indoor address operation was performed during setting of automatic address of other system When automatic outdoor address operation was performed during setting of automatic indoor address of other system
E15	—	E15	42	●	●	@		There is no indoor during automatic address	No receiving of signal from outdoor unit during automatic address
E16	00: Capacity over 01 ~ : No. of connected units	E16	89	●	●	@		No. of connected indoor units/Capacity over	Total capacity of indoor units was over the total outdoor capacity x 135%.
E19	00: No center 02: 2 or more header units	E19	96	●	●	@		No. of header outdoor units error	There is no header outdoor unit or there are multiple header outdoor units in 1 line.
E20	01: Connection of other system outdoor 02: Connection of other system indoor	E20	42	●	●	@		Connection of other system during automatic address	When indoor unit of other line was detected during setting of automatic address
E23	—	E23	15	●	●	@		Communication (send) error between outdoor units	When sending operation to other outdoor unit was impossible
E25	—	E25	15	●	●	@		Duplicated setting of follower outdoor address	Duplicated outdoor address that was manually set
E26	No. of outdoor units with normal receiving	E26	15	●	●	@		Decrease of connected outdoor units	There was no communication from follower outdoor unit (Decrease of No. of connected follower outdoor units)
E28	Detected outdoor unit No.	E28	d2	●	●	@		Error of follower outdoor units	When header outdoor unit detected error of the follower outdoor unit (Follower outdoor unit: Details display)
E31	01: A3-IPDU1 error 02: A3-IPDU2 error 03: A3-IPDU1/2 error 04: Fan IPDU error 05: A3-IPDU1 + Fan IPDU error 06: A3-IPDU2 + Fan IPDU error 07: All IPDU error	E31	CF	●	●	@		IPDU communication error	No communication of each IPDU (P.C. board) in inverter box
F04	—	F04	19	@	@	○	A	Outdoor discharge temp. sensor (TD1) error	Open/short of discharge temp. sensor (TD1) was detected.
F05	—	F05	A1	@	@	○	A	Outdoor discharge temp. sensor (TD2) error	Open/short of discharge temp. sensor (TD2) was detected.
F06	—	F06	18	@	@	○	A	Outdoor heat exchanger temp. (TE1) error	Open/short of heat exchanger temp. sensor (TE1) was detected.
F07	—	F07	18	@	@	○	A	Outdoor liquid temp. sensor (TL) error	Open/short of outdoor liquid temp. sensor (TL) was detected.
F08	—	F08	1b	@	@	○	A	Outdoor external temp. sensor (TO) error	Open/short of external temp. sensor (TO) was detected.
F12	—	F12	A2	@	@	○	A	Outdoor suction temp. sensor (TS1) error	Open/short of outdoor suction temp. sensor (TS1) was detected.
F15	—	F15	18	@	@	○	A	Outdoor temp. sensor (TE, TL) miswiring	Miswiring by temp. sensor (TE, TL) was detected.
F16	—	F16	43	@	@	○	A	Outdoor pressure sensor (Pd, Ps) miswiring	Miswiring by outdoor pressure sensor (Pd, Ps) was detected.
F23	—	F23	43	@	@	○	A	Low pressure (Ps) sensor error	Output voltage of low pressure (Ps) sensor detected 0.
F24	—	F24	43	@	@	○	A	High pressure (Pd) sensor error	When output voltage of high pressure (Pd) sensor was 0 or when abnormal value was detected during stop of compressor
F31	—	F31	1C	@	@	○	S	Outdoor EEPROM error	Outdoor EEPROM error (Center unit stops with alarm and follower unit continues operation.)

(*) O: Goes on, ◎: Flashes, ●: Goes off
 A (Alternate) : Flashing condition is alternate when there are two flashing LED.
 S (Simultaneously) : Two LED flash simultaneously when there are two flashing LED.

Check code display				Sensor lamp display				Main defective position	Description
Outdoor 7-segment		TCC-LINK central & remote controller	AI-NET central (Network adapter use)	Block display (*)					
Auxiliary code				Operation	Timer	Ready	Flash		
H04	—	H04	44	●	◎	●		Compressor1 case thermo operation	When case thermo of compressor 1 performed protective operation
H06	—	H06	20	●	◎	●		Low pressure protective operation	Protective detection operation by low pressure (Ps) sensor
H07	—	H07	d7	●	◎	●		Oil face drop detection protection	Protective detection operation by temp. sensor (TK1 to 4) for oil face detection
H08	01: TK1 sensor error 02: TK2 sensor error 03: TK3 sensor error 04: TK4 sensor error	H08	d4	●	◎	●		Error of temp. sensor (TK1 to 4) for oil face detection	When open/short of temp. sensor (TK1 to 4) for oil face detection was detected
H14	—	H14	44	●	◎	●		Compressor2 case thermo operation	Case thermo of compressor2 performed protective operation.
H16	01: TK1 oil circuit system error 02: TK2 oil circuit system error 03: TK3 oil circuit system error 04: TK4 oil circuit system error	H16	d7	●	◎	●		Oil face detection circuit system error	After start of compressor operation, the temp. variation of temp. sensor (TK1 to 4) for oil face detection was not detected.
L04	—	L04	96	◎	○	◎	S	Duplicated outdoor line address	Duplicated setting of line address against outdoor units in different refrigerant lines
L06	No. of priority indoor units (Individual display: [L05/L06])	L05	96	◎	●	◎	S	Duplicated priority indoor units (Displayed in the priority indoor)	When there were multiple priority indoor units (against priority indoor unit)
		L06	96	◎	●	◎	S	Duplicated priority indoor units (Displayed in except priority indoor)	When there were multiple priority indoor units (against not priority indoor unit)
L08	—	(L08)	(99)	◎	●	◎	S	Unset indoor group address	There was indoor unit that indoor group address was not set (Detected at indoor unit side also)
L10	—	L10	88	◎	○	◎	S	Unset outdoor capacity	When capacity of outdoor unit was not set (Replace service P.C. board.)
L18	—	L18	8A	◎	○	◎	S	Flow selector unit system error	COOL/HEAT cycle error due to mispiping was detected.
L28	—	L28	46	◎	○	◎	S	No. of connected outdoor units over	No. of connected outdoor units was over 4.
L29	01: A3-IPDU1 error 02: A3-IPDU2 error 03: A3-IPDU1, 2 error 04: Fan IPDU error 05: A3-IPDU1 + fan IPDU error 06: A3-IPDU2 + fan IPDU error 07: All IPDU error	L29	CF	◎	○	◎	S	No. of IPDU units' error	When No. of IPDU (P.C. board) was little in the inverter box
L30	Detected indoor unit No.	(L30)	(b6)	◎	○	◎	S	External error input in indoor unit (Interlock)	There was indoor unit which stopped abnormally due to external error input in 1 line. (β Indoor unit detected.)
P03	—	P03	1E	◎	●	◎	A	Outdoor discharge (TD1) temp. error	When high temp. error was detected by discharge temp. sensor (TD1)
P05	01: Detection of open phase 02: Negative phase error	P05	AF	◎	●	◎	A	Detection of open phase/Negative phase error	Open phase/Negative phase error was detected when power was supplied.
P07	01: Compressor 1 side 02: Compressor 2 side	P07	1C	◎	●	◎	A	Heat sink overheat error	When high temp. error was detected by outdoor IGBT incorporated temp. sensor (TH)
P10	Detected indoor unit No.	(P10)	(Ob)	●	◎	◎	A	There is outdoor unit with detection of overflow	There was indoor unit which stopped abnormally due to detection of overflow in 1 line. (β Indoor unit detected.)
P13	—	P13	47	●	◎	◎	A	Outdoor liquid back detection error	When error was judged as liquid back operation from the refrigerant cycle status
P15	01: TS condition 02: TD condition	P15	AE	◎	●	◎	A	Gas leak detection	The outdoor suction temp. sensor (TS1) detected high temperature continuously and repeatedly over the standard value.
P17	—	P17	bb	◎	●	◎	A	Outdoor discharge (TD2) temp. error	Discharge temp. sensor (TD2) detected high temp. error.
P19	Detected outdoor unit No.	P19	O8	◎	●	◎	A	4-way valve inverse error	Error of refrigerant cycle error was detected during heating operation.
P20	—	P20	22	◎	●	◎	A	High pressure protective operation	High pressure (Pd) sensor detected value over the standard value.

[IPDU in S-MMS standard outdoor unit detects: Representative example]

(*) O: Goes on, ◎: Flashes, ●: Goes off
 A (Alternate) : Flashing condition is alternate when there are two flashing LED.
 S (Simultaneously) : Two LED flash simultaneously when there are two flashing LED.

Check code display			Sensor lamp display				Main defective position	Description
Outdoor 7-segment	TCC-LINK central & remote controller	AI-NET central (Network adapter use)	Block display (*)					
Auxiliary code			Operation	Timer	Ready	Flash		
F13 01: Compressor 1 side 02: Compressor 2 side	F13	43	◎	◎	○	A	Outdoor IGBT incorporated temp. sensor (TH) error	When open/short of outdoor IGBT incorporated temp. sensor (TH) was detected
H01 01: Compressor 1 side 02: Compressor 2 side	H01	1F	●	◎	●		Compressor break-down	When inverter current (Idc) detection circuit detected over-current
H02 01: Compressor 1 side 02: Compressor 2 side	H02	1d	●	◎	●		Compressor error (Lock)	When lock of compressor was detected
H03 01: Compressor 1 side 02: Compressor 2 side	H03	17	●	◎	●		Current detection circuit error	Defective current was detected during stop of compressor.
P04 01: Compressor 1 side 02: Compressor 2 side	P04	21	◎	●	◎	A	High pressure SW system operation	High pressure SW operated.
P07 01: Compressor 1 side 02: Compressor 2 side	P07	1C	◎	●	◎	A	Heat sink overheat error	Outdoor IGBT incorporated temp. sensor (TH) detected high temp. error.
P22 04: rpm difference error 06: Max. rpm over 08: Out of step 0A: Idc lock 0C: Fan lock 0d: Lock 0E: Synchronous error 0F: Braking error	P22	1A	◎	●	◎	A	IPDU error for outdoor fan	IPDU for outdoor fan detected each error.
P26 01: Compressor 1 side 02: Compressor 2 side	P26	14	◎	●	◎	A	G-Tr (IGBT) short-circuit protective error	Short-circuit protective operation (Instantaneous over-current) of compressor motor drive circuit element worked.
P29 01: Compressor 1 side 02: Compressor 2 sid	P29	16	◎	●	◎	A	Compressor position detection circuit system error	Position detect error of compressor motor was detected.

Note) The above check codes are the representative examples and they differ according to the combined outdoor units (SHRM, etc.).
 For details, refer to the service guide for the corresponding outdoor unit.

9-3. Troubleshooting by Check Display on Remote Controller

■ In case of wired remote controller (RBC-AMT32E)

1. Confirmation and check

When a trouble occurred on the air conditioner, the check code and the indoor unit No. are displayed on the display section of the remote controller.

The check code is displayed while the air conditioner operates.

If the display disappeared, operate the air conditioner and check the error based upon the following "Confirmation of error history".

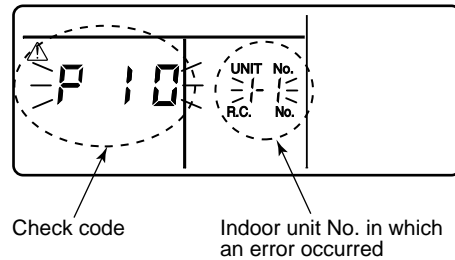

2. Confirmation of error history

When a trouble occurred on the air conditioner, the error history can be confirmed with the following procedure.

(Up to 4 error histories are stored in memory.)

This history can be confirmed from either operating status or stop status.

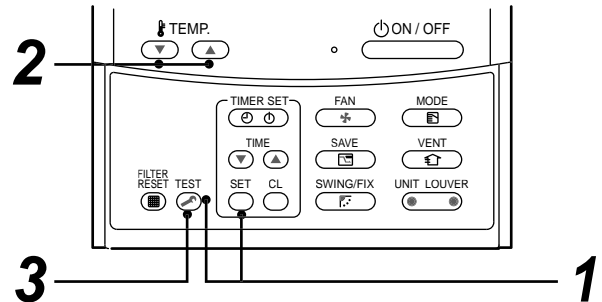

Procedure	Description
1	<p>When pushing and buttons simultaneously for 4 seconds or more, the below display appears. If [Service Check] is displayed, the mode enters in the error history mode.</p> <ul style="list-style-type: none"> • [01: Error history order] is displayed in CODE No. window. • [Check Code] is displayed in check code window. • [Indoor unit address with error] is displayed in UNIT No.
2	<p>Every pushing temp. set / buttons, the error histories stored in the memory are displayed in order. The numbers in CODE No. indicates CODE No. [01] (Latest) to [04] (Oldest).</p> <p>CAUTION Do not push button because all the error histories of the indoor unit will be deleted.</p>
3	<p>After confirmation, push button to return to the usual display.</p>

How to read the check monitor display

<7-segment display>



<How to read>

0 1 2 3 4 5 6 7 8 9 A b C d E F H J L P

■ In case of central remote controller (TCB-SC642TLE2)

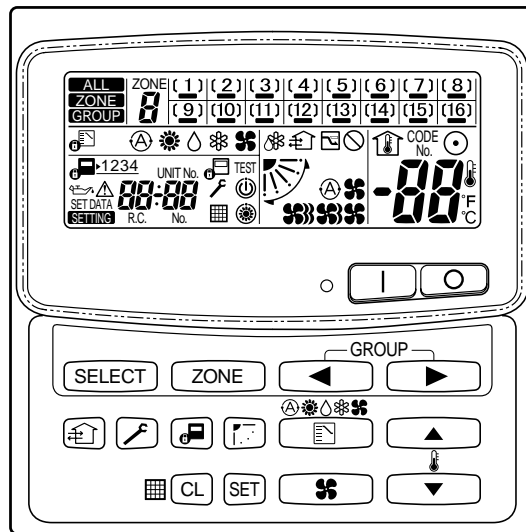

1. Confirmation and check

When a trouble occurred on the air conditioner, the check code and the indoor unit No. are displayed on the display section of the remote controller.

The check code is displayed while the air conditioner operates.

If the display disappeared, operate the air conditioner and check the error based upon the following "Confirmation of error history".

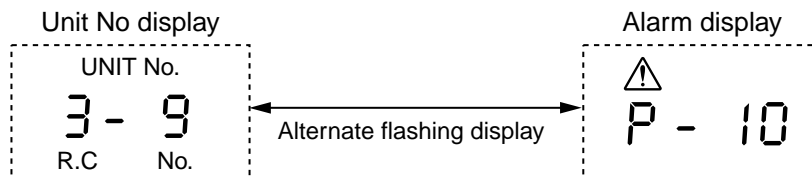

2. Confirmation of error history

When a trouble occurred on the air conditioner, the error history can be confirmed with the following procedure. (Up to 4 error histories are stored in memory.)

This history can be confirmed from either operating or stop.

- 1) Push and buttons in succession for 4 seconds or more.
- 2) SERVICE CHECK goes on and Item code 01 goes on.
- 3) When selecting (flash) the group number if there is the alarm history, the UNIT number and the latest alarm history are displayed alternately.
* In this time, the temperature cannot be set up.
- 4) To confirm the alarm history other than the latest one, push temp. set / to select Item code (01 to 04).
- 5) To confirm the alarm in the other group, push and to select the group number
Do not push button because all the alarm histories of the currently selected group are deleted.
- 6) To finish the service check, push button.

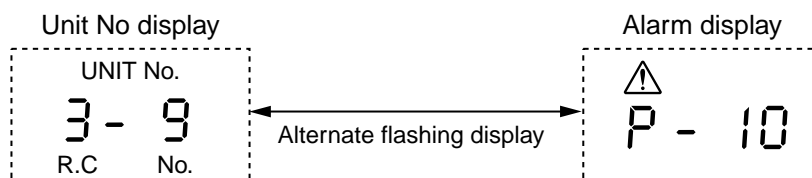





■ Indoor unit display part (Receiving unit) (Wireless type)

When specifying the check code, check 7-segment display on the center unit.

For the check code which is not displayed on the outdoor 7-segment, confirm it in Section "9-2 How to Check / Check code display list (Indoor unit)".

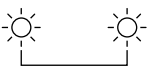
● : Goes off, ○ : Goes on, ☼ : Flash (0.5 second)

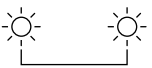
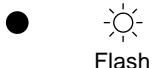
Lamp indication	Check code	Cause of trouble occurrence
Operation Timer Ready ● ● ● No indication at all	—	Power supply OFF or miswiring between receiving unit and indoor unit
Operation Timer Ready ☼ ● ● Flash	E01	Receiving error
	E02	Sending error
	E03	Communication interruption
	E08	Duplicated indoor unit No. (Address)
	E09	Duplicated header units of remote controller
	E10	Communication error between MCU on indoor unit P.C. board
	E12	Automatic address start error
	E18	Wire connection error between indoor units, indoor power supply OFF
Operation Timer Ready ● ● ☼ Flash	E04	Miswiring or wire connection error between indoor unit and outdoor unit (Communication interruption between indoor and outdoor units)
	E06	Communication (receiving) error between indoor and outdoor units, decrease of No. of connected indoor units
	E07	Communication (sending) error between indoor and outdoor units
	E15	No indoor unit during setting of automatic address
	E16	No. of connected indoor units, capacity over
	E19	Error of No. of center unit
	E20	Disagreement of refrigerant pipe communication during setting of automatic address
	E23	Communication (sending) error between outdoor units
	E25	Duplicated setting of follower unit address
	E26	Communication (receiving) error between outdoor units, decrease of No. of connected outdoor units
	E28	Follower unit error
	E31	IPDU communication error
Operation Timer Ready ● ☼ ☼ Alternate flash	P01	Indoor fan error
	P10	Indoor overflow error
	P12	Indoor fan error
	P13	Outdoor unit liquid back detection error
Operation Timer Ready ☼ ● ☼ Alternate flash	P03	Outdoor unit discharge temp. (TD1) error
	P04	Outdoor unit high pressure switch operation
	P05	Outdoor unit open phase error was detected, negative phase error was detected
	P07	Outdoor unit heat sink overheat error: Heat radiation error of electric part (IGBT) in outdoor unit
	P15	Gas leak was detected: Short of refrigerant charge amount
	P17	Outdoor unit discharge temp. (TD2) error
	P19	Outdoor unit 4-way valve inverse error
	P20	High pressure protection error
	P22	Outdoor unit DC fan error
	P26	Outdoor unit G-Tr short-circuit error
	P29	Compressor position detection circuit error
	P31	Other indoor unit stopped due to error in the group.

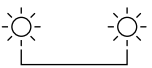
Lamp indication	Check code	Cause of trouble occurrence	
Operation Timer Ready  Alternate flash	F01	Heat exchanger sensor (TCJ) error Heat exchanger sensor (TC2) error Heat exchanger sensor (TC1) error Room temp. sensor (TA) error } Temp. sensor error in indoor unit	
	F02		
	F03		
	F10		
Operation Timer Ready  Alternate flash	F04	Discharge temp. sensor (TD1) error Discharge temp. sensor (TD2) error Heat exchanger sensor (TE1) error Liquid temp. sensor (TL) error Outside temp. sensor (TO) error Suction temp. sensor (TS1) error Heat sink sensor (TH) error } Outdoor unit temp. sensor error	
	F05		
	F06		
	F07		
	F08		
	F12		
	F13		
	F15	Misconnection of heat exchanger sensor (TE) with liquid temp. sensor (TL) → Miswiring of temp. sensor in outdoor unit or miss-mounting	
	F16	Miswiring between high pressure sensor (Pd) and low pressure sensor (Ps) → Misconnection of pressure sensor in outdoor unit	
	Operation Timer Ready Simultaneous flash	F23	Low pressure sensor (Ps) error High pressure sensor (Pd) error } Pressure sensor error in outdoor unit
F24			
Operation Timer Ready  Simultaneous flash	F29	Indoor unit EEPROM error	
Operation Timer Ready  Flash	H01	Compressor break-down Compressor lock Current detection circuit error } Outdoor unit compressor system error	
	H02		
	H03		
	H04	Compressor 1 case thermo operation	
	H06	Low pressure (Ps) drop error	Protections stop of outdoor unit
	H07	Oil face drop detection error	
	H08	Oil face detection circuit system temp. sensor (TK1, TK2, TK3, TK4) error	
	H14	Compressor 2 chase thermo operation: Protective device of outdoor unit operated.	
	H16	Oil face detection circuit system error: Outdoor unit TK1, TK2, TK3, TK4 circuit system error	
Operation Timer Ready  Simultaneous flash	L03	Duplicated header units in indoor unit	
	L05	Duplicated priority indoor unit (Displayed in the room with priority)	
	L06	Duplicated priority indoor unit (Displayed in a room except one with priority)	
	L07	Group cable was connected to individual indoor unit.	
	L08	Indoor group address was unset.	
	L09	Indoor capacity was unset.	
Operation Timer Ready  Simultaneous flash	L04	Duplicated setting of outdoor line address	
	L10	Outdoor capacity was unset.	
	L17	Disagreement error of outdoor unit type	
	L18	COOL/HEAT select unit system error	
	L20	Duplicated address of central control system	
	L28	No. of connected outdoor units over	
	L29	Defective No. of IPDU	
L30	Indoor unit outside interlock error		
Operation Timer Ready  Simultaneous flash	F31	Outdoor unit EEPROM error	

■ Others (Except check code)

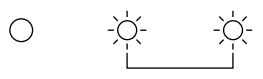
Lamp indication	Check code	Cause of trouble occurrence
Operation Timer Ready  Simultaneous flash	—	During test run
Operation Timer Ready  Alternate flash	—	COOL/HEAT disagreement (Automatic cooling/heating setup to automatic cooling/heating unavailable model, heating setup to cooling only model)

9-4. Check Code and Check Position Displayed on the Remote Controller and Outdoor Unit (7-Segment Display of Interface)

<In case of SUPER MODULAR MULTI SYSTEM>

Main remote controller	Check code		Detected position	Check code name	Status	Error detection condition	Check item (position)
	Outdoor 7-segment display						
	Check code	Auxiliary code					
E01	—	—	Remote controller	Communication error between indoor and remote controller (Detected at remote controller side)	Corresponding unit only stops.	Communication interrupted between indoor P.C. board and remote controller.	<ul style="list-style-type: none"> • Check remote controller inter-unit cable (A/B). • Check disconnection, connector contact error. • Check indoor power supply. • Check indoor P.C. board error. • Check remote controller address setup. (When two remote controllers operate) • Check remote controller P.C. board.
E02	—	—	Remote controller	Remote controller sending error	Corresponding unit only stops.	Signal could not be sent from remote controller to indoor unit.	<ul style="list-style-type: none"> • Check the communication wire of remote controller: Exchange remote controller.
E03	—	—	Indoor unit	Communication error between indoor and remote controller (Detected at indoor side)	Corresponding unit only stops.	No communication from remote controller (including wireless) and communication adapter.	<ul style="list-style-type: none"> • Check remote controller and communication adapter wiring.
E04	—	—	Indoor unit	Indoor/outdoor communication circuit error (Detected at indoor side)	Corresponding unit only stops.	Indoor unit does not receive communication from outdoor unit.	<ul style="list-style-type: none"> • Check power-ON order of indoor/outdoor. • Check indoor address setup. • Check inter-unit cabling between indoor and outdoor. • Check outdoor end terminal resistance setup (SW30-2).
E06	E06	No. of indoor units which received signal normally	I/F	Decreased number of indoor units	All stop	When signal is not sent for a certain period from the indoor unit which has been used to send signals.	<ul style="list-style-type: none"> • Check the power supply of indoor unit. (Power-ON) • Check connection of communication line between indoor and outdoor. • Check connector connection for communication in indoor P.C. board. • Check connector connection for communication in outdoor P.C. board. • Check indoor P.C. board failure. • Check outdoor P.C. board (I/F) failure.
—	E07	—	I/F	Indoor/outdoor communication circuit error (Detected at outdoor side)	All stop	Transmission from outdoor to indoor cannot continue for 30 seconds.	<ul style="list-style-type: none"> • Check outdoor terminator resistor setup (SW30-2). • Check the communication connection between indoor and outdoor.
E08	E08	Duplicated indoor addresses	Indoor I/F	Duplicated indoor addresses	All stop	Multiple indoor unit address setup are duplicated.	<ul style="list-style-type: none"> • Check indoor address. • Check the change of remote controller connection (Group / individual) after setup of indoor address.
E09	—	—	Remote controller	Duplicated master remote controllers	Corresponding unit only stops.	In 2-remote controller control (including wireless), both are setup as master (Header indoor unit stops and other indoor unit is operating.)	<ul style="list-style-type: none"> • Check remote controller setup. • Check remote controller P.C. board.
E10	—	—	Indoor unit	Communication error between indoor P.C. board assembly	Corresponding unit only stops.	Communication was not succeeded after power was supplied or during communication.	<ul style="list-style-type: none"> • Indoor P.C. board failure
E12	E12	01: Indoor/outdoor communication 02: Between outdoors communication	I/F	Automatic address start error	All stop	<ul style="list-style-type: none"> • When indoor automatic address started, other refrigerant circuit system was setting automatic address. • When outdoor automatic address started, indoor automatic address was executed. 	<ul style="list-style-type: none"> • Setup the address again after disconnecting communication connection with other refrigerant circuit system.

Main remote controller	Check code		Detected position	Check code name	Status	Error detection condition	Check item (position)
	Outdoor 7-segment display						
	Check code	Auxiliary code					
E15	E15	—	I/F	No corresponding indoor unit during automatic address	All stop	Indoor unit is not found when indoor automatic address start was set up.	<ul style="list-style-type: none"> • Check the communication line connection between indoor and outdoor. • Check the electric power line error in indoor. • Check the noise of surrounding devices. • Power failure • Check indoor P.C. board error.
E16	E16	00: Capacity over 01 to: No. of connected units	I/F	No. of connected indoor units / Capacity over	All stop	<ul style="list-style-type: none"> • Total capacity of indoor units exceeded 135% of total outdoor capacity. • No. of connected indoor units are more than 48 units. <p>[Note] If this code appears after backup setup of outdoor unit trouble, set up "No. capacity-over detection".</p> <p><Setup method of "No. capacity-over detection"> Turn on SW09/Bit 2 on I/F P.C. board of outdoor header unit.</p>	<ul style="list-style-type: none"> • Check the connection capacity of indoor unit. • Check the HP capacity of indoor unit. • Check the indoor/outdoor capacity setup • Check the No. of connected indoor units. • Check the outdoor I/F P.C. board error
E18	—	—	Indoor unit	Communication error between indoor header and follower units	Corresponding unit only stops.	Regular communication between indoor header and follower units	<ul style="list-style-type: none"> • Check cable of the remote controller. • Check power cabling of indoor. • Check P.C. board of indoor.
E19	E19	00: No header unit 02: Two or more header units	I/F	Header outdoor unit quantity error	All stop	<ul style="list-style-type: none"> • There are multiple header outdoor units in 1 line. • There is none of header outdoor unit in 1 line. 	<ul style="list-style-type: none"> • The outdoor unit connected with communication cable between indoor and outdoor (U1.U2) is the outdoor unit. • Check connection of communication line between indoor and outdoor. • Check outdoor P.C. board(I/F) error.
E20	E20	01: Connection of outdoor of other line 02: Connection of indoor of other line	I/F	Other line unit connected during automatic address	All stop	Unit of other line was connected when indoor automatic address started.	Separate the cable between lines according to automatic address setup method in "Address setup".
E23	E23	—	I/F	Communication sending error between outdoor units	All stop	Transmission of other outdoor unit was unavailable for 30 seconds or more.	<ul style="list-style-type: none"> • Check power supply in outdoor unit. (Is power supplied?) • Check connection or disconnection of connecting wire between outdoor units. • Check connection of connector for outdoor P.C. board communication. • Check outdoor P.C. board (I/F) error. • Check terminal resistance setting of communication between outdoor units
E25	E25	—	I/F	Duplicated outdoor follower address setup	All stop	Outdoor addresses manually set up are duplicated.	[Note] Do not set up the outdoor address manually.
E26	E26	No. of normally received outdoor units	I/F	Decreased number of connected outdoor units	All stop	The signal was not returned for constant from the outdoor unit which was receiving signal.	<ul style="list-style-type: none"> • Outdoor backup is being set. • Check power supply of outdoor unit. (Is power supplied?) • Check connection or disconnection of connecting wire between outdoor units. • Check connection of connector for outdoor P.C. board communication. • Check outdoor P.C. board (I/F) error.
<Convenient functions>							
<p>When pushing SW04 for 1 second or more under condition that [E28] is displayed on 7-segment display of outdoor header unit, the fan of outdoor unit which stopped abnormally starts rotating. If pushing SW04 and SW05 simultaneously, the fan of normal outdoor unit operates. When pushing SW05 singly, the operation of fan is cleared.</p>							
E28	E28	No. of detected outdoor units	I/F	Outdoor follower unit error	All stop	Outdoor header unit received error code from outdoor follower unit.	<ul style="list-style-type: none"> • Check the check code of outdoor follower unit.

Main remote controller	Check code		Detected position	Check code name	Status	Error detection condition	Check item (position)
	Outdoor 7-segment display						
	Check code	Auxiliary code					
E31	E31	01: IPDU1 error 02: IPDU2 error 03: IPDU1, 2 errors 04: Fan IPDU error 05: IPDU1 + Fan IPDU error 06: IPDU2 + Fan IPDU error 07: All IPDU error or communication error between IPDU and I/F P.C. board or outdoor I/F P.C. board error	I/F	IPDU communication error	All stop	Communication of each IPDU (P.C. board) in inverter box interrupted.	<ul style="list-style-type: none"> • Check connection of communication connector and disconnection between IPDU and I/F P.C. board. • Check outdoor P.C. board (I/F, IPDU, Fan IPDU) error. • Check external noise.
F01	—	—	Indoor unit	Indoor TCJ sensor error	Corresponding unit only stops.	<ul style="list-style-type: none"> • Resistance value of sensor is infinite or zero. (Open/Short) 	<ul style="list-style-type: none"> • Check connection/cabling of TCJ sensor connector. • Check characteristics of TCJ sensor resistance value. • Check indoor P.C. board error.
F02	—	—	Indoor unit	Indoor TC2 sensor error	Corresponding unit only stops.	<ul style="list-style-type: none"> • Resistance value of sensor is infinite or zero. (Open/Short). 	<ul style="list-style-type: none"> • Check connection/cabling of TC2 sensor connector. • Check characteristics of TC2 sensor resistance value. • Check indoor P.C. board error.
F03	—	—	Indoor unit	Indoor TC1 sensor error	Corresponding unit only stops.	<ul style="list-style-type: none"> • Resistance value of sensor is infinite or zero. (Open/Short). 	<ul style="list-style-type: none"> • Check connection/cabling of TC1 sensor connector. • Check characteristics of TC1 sensor resistance value. • Check indoor P.C. board error.
F04	F04	—	I/F	TD1 sensor error	All stop	<ul style="list-style-type: none"> • Resistance value of sensor is infinite or zero. (Open/Short) 	<ul style="list-style-type: none"> • Check connection of TD1 sensor connector. • Check characteristics of TD1 sensor resistance value. • Check outdoor P.C. board (I/F) error.
F05	F05	—	I/F	TD2 sensor error	All stop	<ul style="list-style-type: none"> • Resistance value of sensor is infinite or zero. (Open/Short) 	<ul style="list-style-type: none"> • Check connection of TD2 sensor connector. • Check characteristics of TD2 sensor resistance value. • Check outdoor P.C. board (I/F) error.
F06	F06	—	I/F	TE1 sensor error	All stop	<ul style="list-style-type: none"> • Resistance value of sensor is infinite or zero. (Open/Short). 	<ul style="list-style-type: none"> • Check connection of TE1 sensor connector. • Check characteristics of TE1 sensor resistance value. • Check outdoor P.C. board (I/F) error.
F07	F07	—	I/F	TL sensor error	All stop	<ul style="list-style-type: none"> • Resistance value of sensor is infinite or zero. (Open/Short). 	<ul style="list-style-type: none"> • Check connection of TL sensor connector. • Check characteristics of TL sensor resistance value. • Check outdoor P.C. board (I/F) error.
F08	F08	—	I/F	TO sensor error	All stop	<ul style="list-style-type: none"> • Resistance value of sensor is infinite or zero. (Open/Short). 	<ul style="list-style-type: none"> • Check connection of TO sensor connector. • Check characteristics of TO sensor resistance value. • Check outdoor P.C. board (I/F) error.
F10	—	—	Indoor	Indoor TA sensor error	Corresponding unit only stops.	<ul style="list-style-type: none"> • Resistance value of sensor is infinite or zero. (Open/Short). 	<ul style="list-style-type: none"> • Check connection/cabling of TA sensor connector. • Check characteristics of TA sensor resistance value. • Check indoor P.C. board error.
F12	F12	—	I/F	TS1 sensor error	All stop	<ul style="list-style-type: none"> • Resistance value of sensor is infinite or zero. (Open/Short). 	<ul style="list-style-type: none"> • Check connection of TS1 sensor connector. • Check characteristics of TS1 sensor resistance value. • Check outdoor P.C. board (I/F) error.
F13	F13	01: Compressor 1 side 02: Compressor 2 side	IPDU	TH sensor error	All stop	<ul style="list-style-type: none"> • Resistance value of sensor is infinite or zero. (Open/Short). 	<ul style="list-style-type: none"> • IGBT built-in temp sensor error → Exchange IPDU P.C. board.

Main remote controller	Check code		Detected position	Check code name	Status	Error detection condition	Check item (position)
	Outdoor 7-segment display						
	Check code	Auxiliary code					
F15	F15	—	I/F	Outdoor temp sensor miscabling (TE1, TL)	All stop	During operation of compressor in HEAT mode, the TE1 detection temp was higher than that of TL by the specified value continued for 3 minutes or more.	<ul style="list-style-type: none"> • Check installation of TE1 sensor and TL sensor. • Check characteristics of TE1 and TL sensor resistance value. • Check outdoor P.C. board (I/F) error.
F16	F16	—	I/F	Outdoor pressure sensor miscabling (Pd, Ps)	All stop	High-pressure Pd sensor and low-pressure Ps sensor were exchanged, or output voltages of both sensors are zero.	<ul style="list-style-type: none"> • Check connection of high-pressure Pd sensor connector. • Check connection of low-pressure Ps sensor connector. • Check pressure sensors Pd and Ps error. • Check outdoor P.C. board (I/F) error. • Check compression error of compressor.
F23	F23	—	I/F	Ps sensor error	All stop	Output voltage of Ps sensor was zero.	<ul style="list-style-type: none"> • Misconnection of Ps sensor and Pd sensor connectors • Check connection of Ps sensor connector. • Check Ps sensor error. • Check compression error of compressor. • Check 4-way valve error. • Check outdoor P.C. board (I/F) error. • Check SV4 circuit error.
F24	F24	—	I/F	Pd sensor error	All stop	Output voltage of Pd sensor was zero. (Sensor Open) Pd > 4.15MPa during stop of compressor	<ul style="list-style-type: none"> • Check connection of Pd sensor connector. • Check Pd sensor error. • Check outdoor P.C. board (I/F) error.
F29	—	—	Indoor	Indoor other error	Corresponding unit only stops.	Indoor P.C. board did not operate normally.	<ul style="list-style-type: none"> • Check indoor P.C. board error (EEPROM error).
F31	F31	—	I/F	Outdoor EEPROM error	All stop (*1)	Outdoor P.C. board (I/F) did not operate normally.	<ul style="list-style-type: none"> • Check power voltage. • Check power noise. • Check outdoor P.C. board (I/F) error.
H01	H01	01: Compressor 1 side 02: Compressor 2 side	IPDU	Compressor breakdown	All stop	Inverter current detection circuit detected over-current and stopped.	<ul style="list-style-type: none"> • Check power voltage. (AC220–240V ± 10%). • Check compressor error. • Check cause of abnormal overload operation. • Check outdoor P.C. board (IPDU) error.
H02	H02	01: Compressor 1 side 02: Compressor 2 side	IPDU	Compressor error (lock) MG-SW error OCR operation	All stop	Over-current was detected several seconds after header compressor had started.	<ul style="list-style-type: none"> • Check compressor error. • Check power voltage. (AC380–10%, 415V +10%). • Check cable of compressor and phase-missing. • Check connector/terminal connection on IPDU P.C. board. • Check conduction of case heater. (Check activation error due to liquid stagnation in compressor.) • Check outdoor P.C. board (IPDU) error. • Check outdoor MG-SW or OCR.
H03	H03	01: Compressor 1 side 02: Compressor 2 side	IPDU	Current detection circuit system error	All stop	While header compressor stopped, current flowed more than the specified current and was detected.	<ul style="list-style-type: none"> • Check cabling of current detection circuit system. • Check outdoor P.C. board (IPDU) error.

(*1) All stop only in case of the header unit. The follower unit continues operation.

MG-SW : Magnet Switch, OCR : Over-current Relay

Main remote controller	Check code		Detected position	Check code name	Status	Error detection condition	Check item (position)
	Outdoor 7-segment display						
	Check code	Auxiliary code					
H04	H04	—	I/F	Compressor 1 case thermo operation	All stop	Compressor 1 case thermostat performed protective operation.	<ul style="list-style-type: none"> • Check compressor 1 case thermo circuit. (Connector, cable, P.C. board) • Check full opening of service valve. (Gas and liquid side) • Check outdoor PMV clogging. (PMV1, 2) • Check SV41 circuit leakage. • Check miscabling/misinstallation of SV41 and SV42. • Check valve open status of indoor PMV. • Check 4-way valve error. • Check refrigerant shortage.
H06	H06	—	I/F	Low-pressure protective operation	All stop	Low-pressure Ps detected operation lower than 0.02MPa.	<ul style="list-style-type: none"> • Check full opening of service valve. (Discharge gas, suction gas and liquid side) • Check outdoor PMV clogging. (PMV1, 2) • Check SV2 circuit and SV4 circuit error. • Check low-pressure Ps sensor error. • Check indoor air filter clogging. • Check valve open of indoor PMV. • Check refrigerant pipe clogging. • Check outdoor fan operation. (All heating, mainly heating, part cooling operation) • Check refrigerant shortage.
H07	H07	—	I/F	Protection for oil level drop detection	All stop	The operating compressor detected oil shortage continuously for 2 hours.	<p><Check all the outdoor units in the corresponding line.></p> <ul style="list-style-type: none"> • Check full opening of service valve of balance pipe. • Check connection and installation of TK1, TK2, TK3, and TK4 sensors. • Check characteristics of TK1, TK2, TK3, and TK4 resistance values. • Check gas leak and oil leak in the same line. • Check refrigerant stagnation in compressor. • Check error of SV3A, SV3B, SV3C, SV3D, and SV3E valves. • Check clogging of oil separator oil return circuit. • Check clogging of oil-equation circuit.
H08	H08	01: TK1 sensor error 02: TK2 sensor error 03: TK3 sensor error 04: TK4 sensor error	I/F	Oil level detective temp sensor error	All stop	• Resistance value of sensor is infinite or zero. (Open/Short)	<ul style="list-style-type: none"> • Check connection of TK1 sensor connector. • Check characteristics of TK1 sensor resistance value. • Check outdoor P.C. board (I/F) error.
					All stop	• Resistance value of sensor is infinite or zero. (Open/Short)	<ul style="list-style-type: none"> • Check connection of TK2 sensor connector. • Check characteristics of TK2 sensor resistance value. • Check outdoor P.C. board (I/F) error.
					All stop	• Resistance value of sensor is infinite or zero. (Open/Short)	<ul style="list-style-type: none"> • Check connection of TK3 sensor connector. • Check characteristics of TK3 sensor resistance value. • Check outdoor P.C. board (I/F) error.
					All stop	• Resistance value of sensor is infinite or zero. (Open/Short)	<ul style="list-style-type: none"> • Check connection of TK4 sensor connector. • Check characteristics of TK4 sensor resistance value. • Check outdoor P.C. board (I/F) error.

Main remote controller	Check code		Detected position	Check code name	Status	Error detection condition	Check item (position)
	Outdoor 7-segment display						
	Check code	Auxiliary code					
H14	H14	—	I/F	Compressor 2 case thermo operation	All stop	Compressor 2 case thermostat operated.	<ul style="list-style-type: none"> • Check compressor 2 case thermo circuit. (Connector, cable, P.C. board) • Check full opening of service valve. (Gas and liquid side) • Check outdoor PMV clogging. (PMV1, 2) • Check SV42 valve leak. • Check miscabling/misinstallation of SV41 and SV42. • Check valve opening of indoor PMV. • Check 4-way valve error. • Check refrigerant shortage.
H16	H16	01: TK1 oil circuit system error 02: TK2 oil circuit system error 03: TK3 oil circuit system error 04: TK4 oil circuit system error	I/F	Oil level detective circuit system error MG-SW error OCR operation	All stop	Temperature change of TK1 could not be detected though compressor 1 started the operation.	<ul style="list-style-type: none"> • Check TK1 sensor coming-off. • Check characteristics of TK1 sensor resistance value. • Check TK1, TK2, TK3, and TK4 misconnection. • Check operation error of SV3E valve. • Check capillary clogging of oil-equalization circuit and operation error of stop valve. • Check refrigerant stagnation in compressor. • Check MG-SW or OCR.
						Temperature change of TK2 could not be detected though compressor 2 started the operation.	<ul style="list-style-type: none"> • Check TK2 sensor coming-off. • Check characteristics of TK2 sensor resistance value. • Check TK1, TK2, TK3, and TK4 misconnection. • Check SV3E valve operation. • Check capillary clogging of oil equalization circuit and check stop valve operation. • Check refrigerant stagnation in compressor shell. • Check MG-SW or OCR.
						Temperature change of TK3 could not be detected though compressor started the operation.	<ul style="list-style-type: none"> • Check TK3 sensor coming-off. • Check characteristics of TK3 sensor resistance value. • Check TK1, TK2, TK3, and TK4 misconnection. • Check SV3E valve operation. • Check capillary clogging of oil-equalization circuit and check valve operation. • Check refrigerant stagnation in compressor shell. • Check MG-SW or OCR.
						Temperature change of TK4 could not be detected though compressor started the operation, or the difference from other TK sensor changed for a constant time only within the specified range.	<ul style="list-style-type: none"> • Check TK4 sensor coming-off. • Check characteristics of TK4 sensor resistance value. • Check TK1, TK2, TK3, and TK4 misconnection. • Check SV3E valve operation. • Check capillary clogging of oil-equalization circuit and check valve operation. • Check refrigerant stagnation in compressor shell. • Check MG-SW or OCR.
L03	—	—	Indoor	Duplicated indoor center units	Corresponding unit only stops.	There are multiple center units in a group.	<ul style="list-style-type: none"> • Check indoor address. • Check the change of remote controller connection (Group/individual) after indoor address setup.
L04	L04	—	I/F	Duplicated outdoor line address	All stop	Line address setup is duplicated against the outdoor unit in different refrigerant pipe system.	<ul style="list-style-type: none"> • Check line address.

Main remote controller	Check code		Detected position	Check code name	Status	Error detection condition	Check item (position)
	Outdoor 7-segment display						
	Check code	Auxiliary code					
L05	—	—	I/F	Duplicated indoor units with priority (Displayed on indoor unit with priority)	All stop	Indoor units with priority were duplicated.	<ul style="list-style-type: none"> Check display of indoor unit with priority.
L06	L06	No. of indoor units with priority	I/F	Duplicated indoor units with priority (Displayed on the unit other than indoor unit with priority)	All stop	Indoor units with priority were duplicated.	<ul style="list-style-type: none"> Check display of indoor unit with priority and outdoor unit.
L07	—	—	Indoor	Group line in individual indoor unit.	Corresponding unit only stops.	At least one indoor unit connected to a group existed in the individual indoor units.	<ul style="list-style-type: none"> Check indoor address.
L08	L08	—	Indoor	Indoor group / address unset	Corresponding unit only stops.	Address was not yet set up.	<ul style="list-style-type: none"> Check indoor address. <p>Note) After installation, this code is displayed when the power is firstly turned on.</p>
L09	—	—	Indoor	Indoor capacity unset	Corresponding unit only stops.	Indoor unit capacity was unset.	Set up indoor capacity. (DN=11)
L10	L10	—	I/F	Outdoor capacity unset	All stop	On the I/F P.C. board for service, jumper line was not cut according to the model.	Check model setup on outdoor I/F P.C. board A'ssy for service.
L17	L17	—	I/F	Inconsistent models of outdoor units		When outdoor unit models are intermingled. When 1/2 series of SHRM was intermingled.	<ul style="list-style-type: none"> Check outdoor units.
L18	L18	Corresponding indoor address	I/F	FS unit system error	Corresponding unit only stops.	An indoor unit which is not connected with FS unit is driving without setup for cooling only mode.	<ul style="list-style-type: none"> Check setup of remote controller (DN=[OFF]). Check FS unit. Check pipe connection to FS unit. (Mis piping between discharge gas and suction gas) Check miswiring/misinstallation of SVS/SVD valves.
L20	—	—	TCC-Link Indoor	Duplicated central control addresses	All stop	Duplicated central control addresses	<ul style="list-style-type: none"> Check central control address. Check network adaptor P.C. board. (In case of TCC-Link)
L28	L28	—	I/F	Quantity over of connected outdoor units	All stop	There were more than four outdoor units.	<ul style="list-style-type: none"> Check No. of connected outdoor units. (Max. 4 units per 1 system) Check communication line between outdoor units. Check outdoor P.C. board (I/F) error.
L29	L29	01: IPDU1 error 02: IPDU2 error 03: IPDU1, 2 errors 04: Fan IPDU error 05: IPDU1 + Fan IPDU error 06: IPDU2 + Fan IPDU error 07: All IPDU error or communication error between IPDU and I/F P.C. board, or outdoor I/F P.C. board error	I/F	IPDU quantity error	All stop	No. of IPDU units detected when power was turned on were less.	<ul style="list-style-type: none"> Check model setup for outdoor I/F service P.C. board. Check connection of UART communication connector. Check IPDU, fan IPDU, and I/F P.C. board error. <p>Note) UART: Universal Asynchronous Receiver Transmitter</p>
L30	L30	Detected indoor address	Indoor	Interlock in indoor unit from outside	Corresponding unit only stops.	<ul style="list-style-type: none"> Outside error input terminal Detected signal to (CN80) for more 1 minute 	<ul style="list-style-type: none"> Outside device is connected to connector (CN80): 1) Check outside device error. 2) Check indoor P.C. board error. Outside device is not connected to connector (CN80): 1) Check indoor P.C. board error.
—	L31	—	I/F	Extended IC (Integrated Circuit) error	Operation continues.	P.C. board (I/F) parts error	Check indoor (I/F) P.C. board.

Main remote controller	Check code		Detected position	Check code name	Status	Error detection condition	Check item (position)
	Outdoor 7-segment display						
	Check code	Auxiliary code					
P01	—	—	Indoor	Indoor fan motor error	Corresponding unit only stops.		<ul style="list-style-type: none"> • Check the lock of fan motor (AC fan). • Check cabling.
P03	P03	—	I/F	Discharge temp TD1 error	All stop	Discharge temp (TD1) exceeded 115°C.	<ul style="list-style-type: none"> • Check full opening of outdoor service valves (Gas side, Liquid side). • Check clogging of outdoor PMV. (PMV1,2) • Check characteristics of TD1 sensor resistance value. • Check refrigerant shortage. • Check 4-way valve error. • Check leakage of SV4 circuit. • Check SV4 circuit. (Miswiring and misinstallation of SV41 and SV42)
P04	P04	01: Compressor 1 side 02: Compressor 2 side	I/F	Actuation of high-pressure SW	All stop	High-pressure SW actuated.	<ul style="list-style-type: none"> • Check connection of high-pressure SW connector. • Check Pd pressure sensor error. • Check full opening of outdoor service valves (Gas side, Liquid side). • Check outdoor fan error. • Check outdoor fan motor error. • Check clogging of outdoor PMV. (PMV1,2) • Check clogging of indoor/outdoor heat exchangers. • Check short-circuiting of outdoor suction/discharge air. • Check clogging of SV2 circuit. • Check outdoor P.C. board (I/F) error. • Check indoor fan system error. (Cause of air volume decrease) • Check opening of indoor PMV. • Check miscabling of communication line between indoor and outdoor. • Check operation error of check valve of discharge pipe. • Check SV4 valve circuit. • Check SV5 valve circuit. • Check refrigerant overcharge.
P05	P05	01: Power supply open phase 02: Power supply negative phase	I/F	Open phase negative phase	All stop	<ul style="list-style-type: none"> • Open phase was detected when the power turned on. • Negative phase was detected when the power turned on. 	<ul style="list-style-type: none"> • Check outdoor power line. • Check outdoor P.C. board (I/F) error.
P07	P07	01: Compressor 1 side 02: Compressor 2 side	IPDU I/F	Heat sink overheat error	All stop	IGBT built-in temp sensor (TH) was overheated.	<ul style="list-style-type: none"> • Check power voltage. • Check outdoor fan system error. • Check clogging of heat sink cooling duct. • Check fixation between IGBT and heat sink. (Check screwing and contact.) • Check IPDU error.(IGBT built-in temp sensor (TH) error).
P10	P10	Indoor address with trouble	Indoor	Indoor overflow error	All stop	<ul style="list-style-type: none"> • Float switch operated. • Float switch circuit disconnected or the connector came off. 	<ul style="list-style-type: none"> • Check the float switch connector. • Check operation of drain pump unit. • Check the drain pump circuit. • Check clogging of drain pipe. • Check indoor P.C. board error.
P12	—	—	Indoor	Indoor fan motor error	Corresponding unit only stops.	<ul style="list-style-type: none"> • The value of motor speed deviated from target value was detected for certain time. • Over-current protection operated. 	<ul style="list-style-type: none"> • Check connection of fan connector and wiring. • Check fan motor error. • Check indoor P.C. board error. • Check influence of outside air control.

Check code			Detected position	Check code name	Status	Error detection condition	Check item (position)
Main remote controller	Outdoor 7-segment display						
	Check code	Auxiliary code					
P13	P13	—	I/F	Outdoor liquid back detection error	All stop	<p><In cooling> While the system operated in cooling mode, high status of high pressure value was detected in the stopped follower unit.</p> <p><In heating> While the system is operating in HEAT mode, outdoor PMV of which opening degree was 100 pulse or less for a certain time.</p>	<ul style="list-style-type: none"> • Check full close operation of outdoor PMV (1, 2). • Check Pd and Ps sensor error. • Check clogging of SV2 circuit. • Check clogging of balance pipe. • Check clogging of SV3B circuit. • Check outdoor P.C. board (I/F) error. • Check capillary clogging of oil return circuit from oil separator. • Check leakage of stop valve in discharge assembly part.
P15	P15	01: TS condition	I/F	Gas leak detection (TS1 condition)	All stop	<p>Protective stop which generates when the status that suction temperature is over the judgment standard temperature continued for 10 minutes was repeated for 4 times or more.</p> <p><TS error judgment standard temperature> In cooling operation: 60°C or higher In heating operation: 40°C or higher</p>	<ul style="list-style-type: none"> • Check refrigerant shortage. • Check full open of outdoor service valves (gas side, liquid side). • Check outdoor PMV clogging (PMV1, 2). • Check characteristics of TS1 sensor resistance value. • Check 4-way valve error. • Check leakage of SV4 circuit.
		02: TD condition	I/F	Gas leak detection (TD condition)	All stop	<p>Protective stop which generates when the status that while compressor is under low frequency operation, the discharge temperature TD1 or TD2 detected 108°C or more continuously for 10 minutes was repeated for 4 times or more.</p>	<ul style="list-style-type: none"> • Check refrigerant shortage. • Check outdoor PMV clogging (PMV1, 2). • Check characteristics of TD1, TD2 sensor resistance value. • Check indoor air filter clogging. • Check pipe clogging. • Check SV4 circuit (Valve leakage, misinstallation)
P17	P17	—	I/F	Discharge temp TD2 error	All stop	<p>Protective stop which generates when the discharge temperature (TD2) was over 115°C was repeated for 4 times or more.</p>	<ul style="list-style-type: none"> • Check full opening of outdoor service valves (gas side, liquid side). • Check clogging of outdoor PMV (PMV1, 2). • Check characteristics of TD2 sensor resistance value. • Check 4-way valve error. • Check leakage of SV4 circuit. • Check SV4 circuit. (Miscabling and misinstallation of SV41 and SV42)
P19	P19	Detected outdoor unit No.	I/F	4-way valve operation error	All stop	<p>When abnormal refrigerating cycle data was detected in heating</p>	<ul style="list-style-type: none"> • Error of 4-way valve error. • Check coil error and connector connection of 4-way valve. • Check characteristics of TS1/TE1 sensor resistance value. • Check characteristics of Pd, Ps pressure sensor output voltage. • Check misconnection of TE1 and TL sensors.
P20	P20	—	I/F	High-pressure protective operation	All stop	<p>Pd sensor detected 3.6MPa or more.</p>	<ul style="list-style-type: none"> • Check Pd pressure sensor error. • Check full opening of service valves (Gas side, Liquid side). • Check outdoor fan error. • Check outdoor fan motor error. • Check clogging of outdoor PMV. (PMV1,2) • Check clogging of indoor/outdoor heat exchangers. • Check air short-circuiting in outdoor unit. • Check clogging of SV2 circuit. • Check outdoor P.C. board (I/F) error. • Check indoor fan system error. (Cause of air volume decrease) • Check valve opening of indoor PMV. • Check miscabling of communication line between indoor and outdoor. • Check operation error of stop valve in discharge assembly part. • Check circuit of gas balance SV4 valve. • Check circuit of SV5 valve. • Check refrigerant overcharge.

Main remote controller	Check code		Detected position	Check code name	Status	Error detection condition	Check item (position)
	Outdoor 7-segment display						
	Check code	Auxiliary code					
P22	P22	08: Out of step 0A: IDC operation 0E: Synchronous error 0F: Braking error 06: Max. rpm over 04: rpm difference error 0D: Lock 0C: Fan lock	IPDU	Outdoor fan IPDU error	All stop	(Auxiliary code: 08) Fan IPDU position detection circuit Position detection was not normally performed.	<ul style="list-style-type: none"> Fan motor check Connection check of connector for fan motor Error check of IPDU P.C. board for fan
					All stop	(Auxiliary code: 0A) Fan IPDU over-current protective circuit When the fan started and while it is operating, the status that current flows over constant flow was detected	<ul style="list-style-type: none"> Fan motor check Error check of IPDU P.C. board for fan
					All stop	(Auxiliary code: 0E) Fan IPDU position detection circuit Position detection was not normally performed.	<ul style="list-style-type: none"> Fan motor check Connection check of connector for fan motor Error check of IPDU P.C. board for fan
					All stop	(Auxiliary code: 0F) Fan IPDU position detection circuit Position detection was not normally performed.	<ul style="list-style-type: none"> Fan motor check Connection check of connector for fan motor Error check of IPDU P.C. board for fan
					All stop	(Auxiliary code: 06) External cause such as blast Position detection was not normally performed. (Restart after 6 seconds)	<ul style="list-style-type: none"> Fan motor check Connection check of connector for fan motor
					All stop	(Auxiliary code: 04) External cause such as blast When difference between target rpm and real rpm is 25% or more (Restart after 6 seconds)	<ul style="list-style-type: none"> Fan motor check Connection check of connector for fan motor
					All stop	(Auxiliary code: 0D) Fan IPDU position detection circuit Position detection was not normally performed. (Windless status)	<ul style="list-style-type: none"> Fan motor check Connection check of connector for fan motor Error check of IPDU P.C. board for fan
					All stop	(Auxiliary code: 0C) External cause such as blast Position detection was not normally performed. (Windy status) (Restart after 6 seconds)	<ul style="list-style-type: none"> Fan motor check Connection check of connector for fan motor
P26	P26	01: Compressor 1 side 02: Compressor 2 side	IPDU	G-Tr short-circuit protection error	All stop	Instantaneous over-current was detected when compressor started.	<ul style="list-style-type: none"> Check connector connection and wiring on IPDU P.C. board. Check compressor error and defect of compressor coil. Check outdoor P.C. board (IPDU) error.
P29	P29	01: Compressor 1 side 02: Compressor 2 side	IPDU	Compressor position detection circuit error	All stop	Position was not normally detected.	<ul style="list-style-type: none"> Check connector connection and wiring. Check compressor error and defect of compressor coil. Check P.C. board (IPDU) error.
P31	—	—	Indoor	Other indoor error (Group follower unit error)	Corresponding unit only stops.	E07/L07/L03/L08 was detected when other indoor unit in the group was defective.	<ul style="list-style-type: none"> Check indoor P.C. board.

Error detected by TCC-LINK central control device

Display on central control device	Check code		Detected position	Check code name	Status	Error detection condition	Check item (position)
	Outdoor 7-segment display						
	Check code	Auxiliary code					
C05	—		TCC-LINK	TCC-LINK central control device transmission error	Operation continued.	Signal is not transmit from central control device.	<ul style="list-style-type: none"> • Check central control device error. • Check communication line error of central control device. • Check setup of terminator resistor.
C06	—			TCC-LINK central control device transmission error	Operation continued.	Signal is not received from central control device.	<ul style="list-style-type: none"> • Check central control device error. • Check communication line error of central control device. • Check setup of terminator resistor. • Check the power of connecting destination connected device. • Check P.C. board error of the connected device.
C12	—		General-purpose equipment I/F	General-purpose controller control Interface batched alarm	Operation continued.	Error was input in general-purpose equipment control interface.	<ul style="list-style-type: none"> • Check error input.
P30	Differs according to error contents of the with alarm		TCC-LINK	Follower unit error of group control	Operation continued.	An error occurred in follower unit of the group control. ([P30] is displayed only on the central remote controller.)	<ul style="list-style-type: none"> • Check the check code of the unit with alarm.
	(L20 is displayed.)			Duplicated central control address	Operation continued.	Central control addresses were duplicated.	<ul style="list-style-type: none"> • Check the address setup.

9-5. Sensor Characteristics

Indoor Unit

■ Temperature sensor characteristics

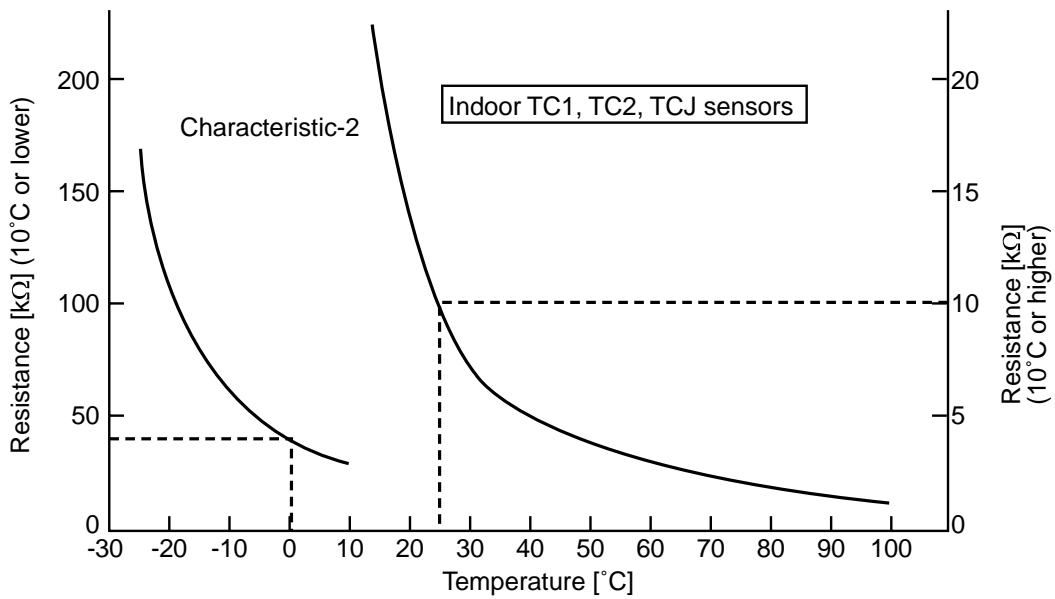
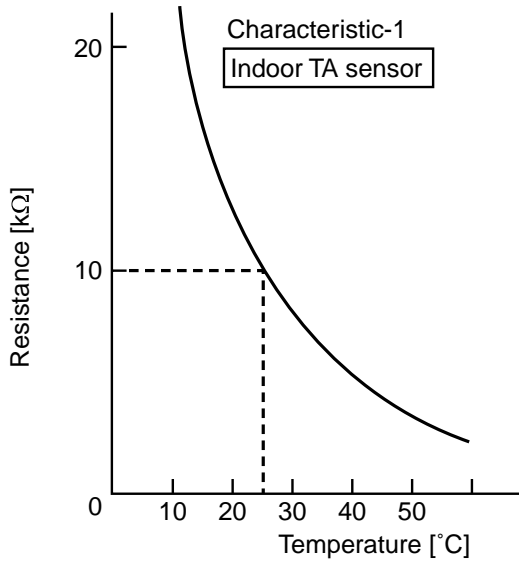

10. DETACHMENTS

No.	Part name	Procedure	Remarks
①	Suction grille	<p style="text-align: center;">CAUTION</p> <p>Be sure to put on the gloves and long-sleeved shirt at disassembling work; otherwise an injury will be caused by a part, etc.</p> <p>1. Detachment</p> <ol style="list-style-type: none"> 1) Stop operation of the air conditioner and then turn off switch of the breaker. 2) Slide the 2 knobs of the suction grille inward and then hang down the suction grille. 3) Remove a strap connecting the panel and the suction grille and then remove the suction grille. <p>2. Attachment</p> <ol style="list-style-type: none"> 1) Hook the suction grille to the panel. 2) Attach strap of the suction grille to the panel as before. 3) Close the suction grille, slide the knobs outward and then fix the panel. 	
②	Electric parts cover	<p>1. Detachment</p> <ol style="list-style-type: none"> 1) Carry out work of item 1. of ①. 2) Remove the fixing screw A which fixes the electric parts cover and loosen the fixing screw B. 3) Pull down the electric parts cover, remove pin of the bell mouth and then slide it to the arrow direction in order to open the claws and the electric parts box cover. <p>2. Attachment</p> <ol style="list-style-type: none"> 1) Close the electric parts cover and slide it, hook claw of the electric parts box, claw of the electric parts box cover and the Dharma doll hole, and then insert pin of the bell mouth into hole of the electric parts box cover. 2) Tighten the fixing screws A and B and then fix the electric parts box cover. 3) Following to work of item 2 of ①, mount the suction grille as before. 	

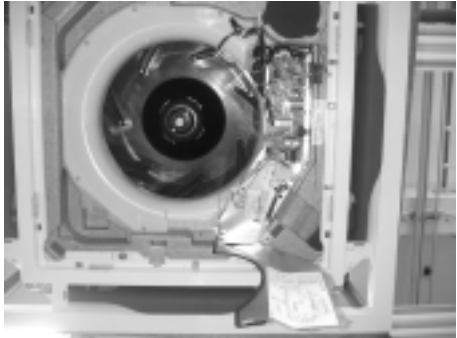
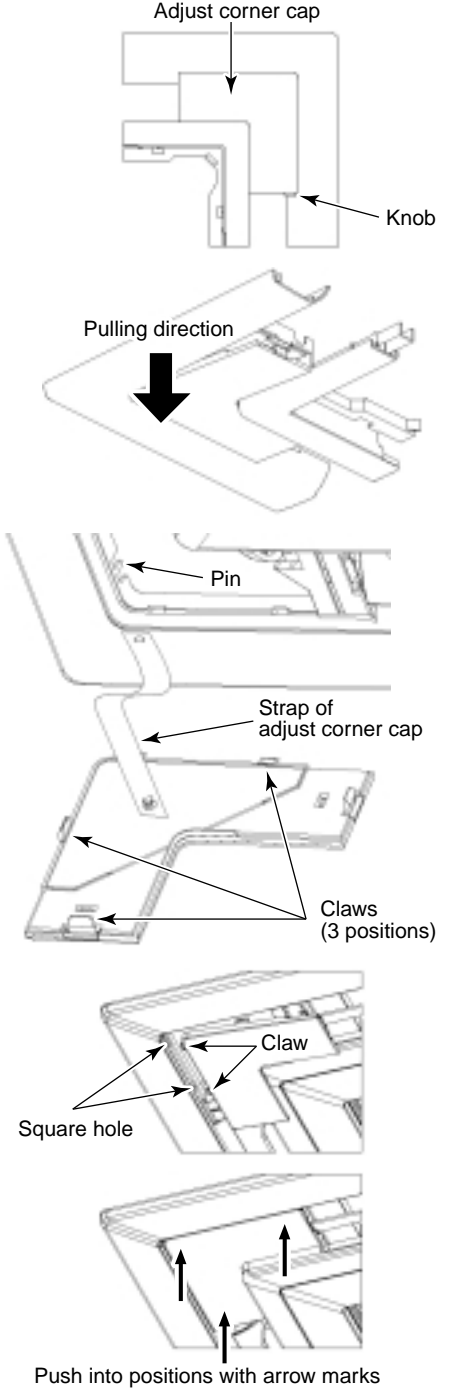
No.	Part name	Procedure	Remarks
②	Electric parts cover (Continued)		
③	Adjust corner cap	<p>1. Detachment</p> <p>1) Pull knob of the adjust corner cap to the arrow direction, remove strap of the adjust corner cap from pin of the panel and then remove all the 4 corners of the cap.</p> <div style="border: 1px solid black; padding: 5px; margin: 10px 0;"> <p>NOTE : The knob is provided to only one side. Be sure to remove the cap of the knob side at first.</p> </div> <p>2. Attachment</p> <p>1) Hook strap of the adjust corner cap securely to pin of the ceiling panel.</p> <p>2) Insert claw of the adjust corner cap into the square hole of the panel. (2 positions)</p> <p>3) Push claws of the adjust corner cap into the positions indicated with arrow marks so that they fit in 3 positions.</p>	

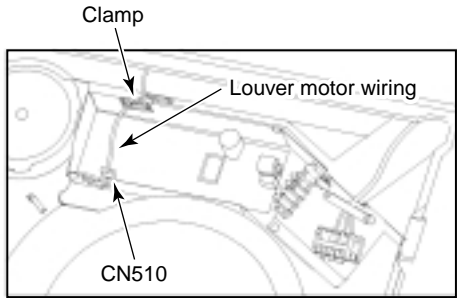
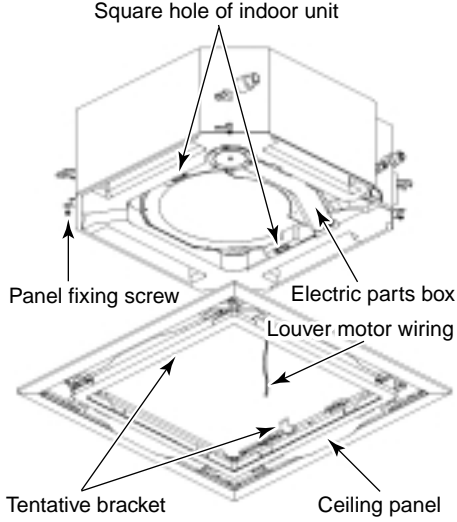
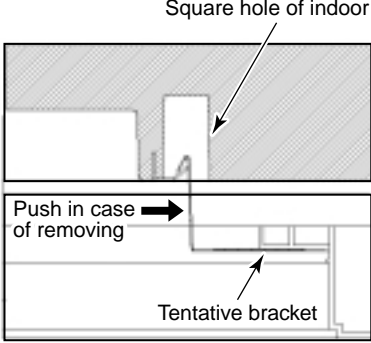
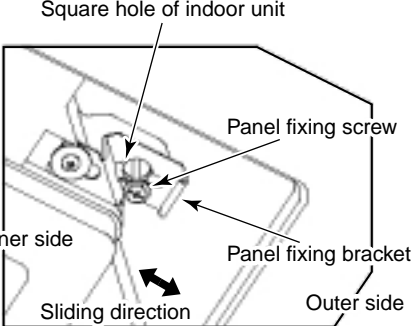
No.	Part name	Procedure	Remarks
④	Ceiling panel	<p>1. Detachment</p> <ol style="list-style-type: none"> 1) Carry out works of item 1 of ② and item 1 of ③. 2) Remove the flap connector (CN510, White, 20P) connected to the control P.C. board and then remove the lead wire from the clamp. <div style="border: 1px solid black; padding: 5px; margin: 10px 0;"> <p>NOTE : Unlock the lock of the housing part and then remove the connector.</p> </div> <ol style="list-style-type: none"> 3) Loosen the panel fixing 4 screws. 4) Slide the panel fixing brackets (4 positions) outward. 5) Push the tentative bracket outward and then remove the ceiling panel. <p>2. Attachment</p> <ol style="list-style-type: none"> 1) Insert the tentative brackets (2 positions) of the ceiling panel into square holes of the indoor unit and then hook the panel tentatively. <div style="border: 1px solid black; padding: 5px; margin: 10px 0;"> <p>NOTE : The ceiling panel has the directional properties against the indoor unit. Direct the louver motor wire to the electric parts box side of the indoor unit.</p> </div> <ol style="list-style-type: none"> 2) Pass the head of the panel fixing screw through hole of the panel fixing bracket and then slide the panel fixing bracket inward. 3) Tighten in the panel fixing screw to fix the ceiling panel. 4) Following to work of item 2 of ③, attach the adjust corner cap as before. 5) Connect the louver connector (CN510, White, 20P) as before and then fix the lead wire with clamp. 6) Following to work of item 2 of ②, mount the electric parts box cover and the suction grille as before. 	 <p>Clamp Louver motor wiring CN510</p>  <p>Square hole of indoor unit Panel fixing screw Electric parts box Louver motor wiring Tentative bracket Ceiling panel</p>  <p>Square hole of indoor unit Push in case of removing Tentative bracket</p>  <p>Square hole of indoor unit Panel fixing screw Panel fixing bracket Inner side Outer side Sliding direction</p>

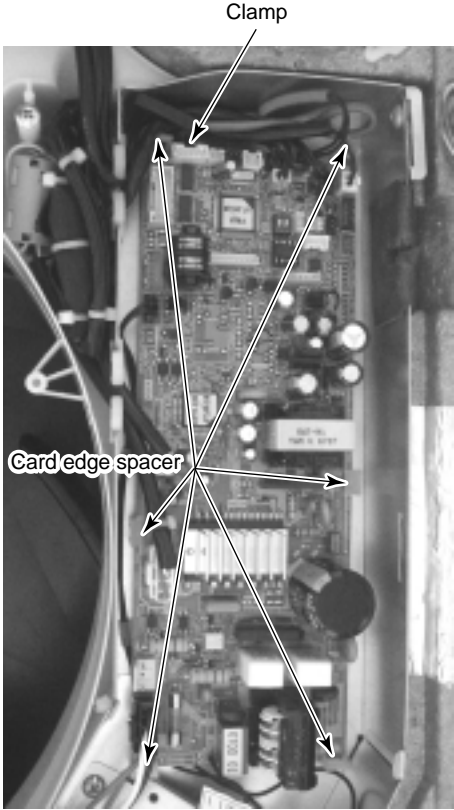

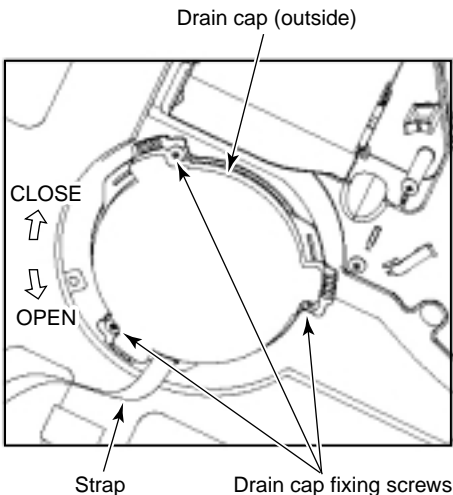
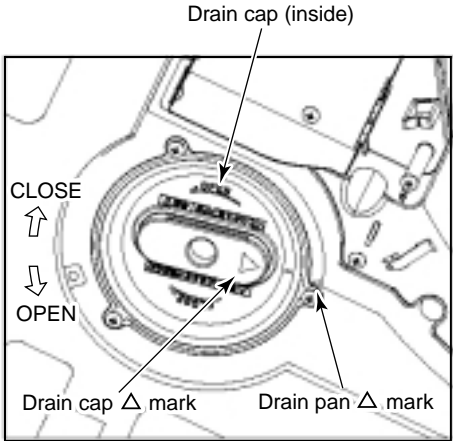
No.	Part name	Procedure	Remarks
⑤	Control P.C. board	<p>1. Detachment</p> <ol style="list-style-type: none"> 1) Carry out work of item 1 of ②. 2) Remove connectors which are connected from the control P.C. board to the other parts and then remove wiring from the clamp. <p>CN510 : Louver motor (20P, White) CN34 : Float switch (3P, Red) CN504 : Drain pump (2P, White) CN100 : TC1 sensor (3P, Brown) CN101 : TC2 sensor (2P, Black) CN102 : TCJ sensor (2P, Red) CN104 : Room temp. Sensor (2P, Yellow) CN333 : Fan motor power supply (5P, White) CN334 : Fan motor position detection (3P, White) CN82 : PMV (6P, Blue)</p> <div style="border: 1px solid black; padding: 5px; margin: 10px 0;"> <p>NOTE : Unlock the lock of the housing part and then remove the connector.</p> </div> <ol style="list-style-type: none"> 3) Unlock the locks of the card edge spacer (6 positions) and then remove the control P.C. board. <p>2. Attachment</p> <ol style="list-style-type: none"> 1) Fix the control P.C. board to the card edge spacer (6 positions) 2) Connect the connector removed in item 1 as before and then fix the wiring with the clamp. 3) Following to work of item 2 of ②, mount the electric parts box cover and the suction grille as before. <hr style="border: 1px solid black; margin: 10px 0;"/> <p style="text-align: center;">CAUTION</p> <hr style="border: 1px solid black; margin: 10px 0;"/> <p>When exchanging P.C. board, mount the ferrite core attached to the existing earth lead to the earth lead of the new P.C. board.</p> <hr style="border: 1px solid black; margin: 10px 0;"/>	

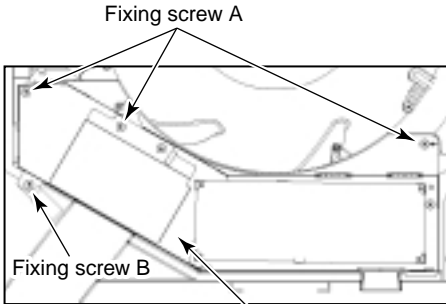
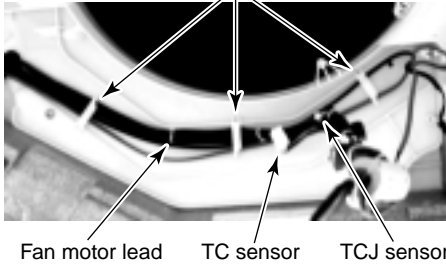
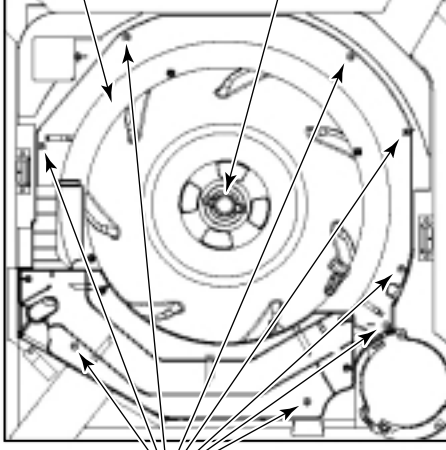
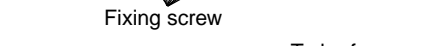
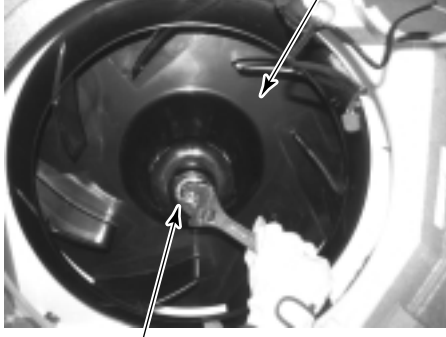
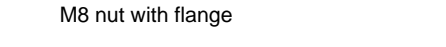
No.	Part name	Procedure	Remarks
⑥	Drain cap	<p>1. Detachment</p> <ol style="list-style-type: none"> 1) Carry out work of item 1 of ①. 2) Loosen screws (3 positions) fixing the drain cap (outside) and then turn the drain cap to the arrow mark direction to remove it. <div style="border: 1px solid black; padding: 5px; margin: 10px 0;"> <p>NOTE : The drain cap is hung down because a strap is attached to it (outside).</p> </div> <ol style="list-style-type: none"> 3) Loosen the cap by turn the drain cap (inside) for approx. 1 turn to OPEN → direction and then drain the drain water accumulated in the drain pan. <div style="border: 1px solid black; padding: 5px; margin: 10px 0;"> <p>NOTE : Be sure to catch drain water using a bucket, etc. when loosening the drain cap. The insulating materials are adhered to the drain cap (outside) and opening part of the drain pan; be careful that they are not come off. If they are come off, stick them as before using double-faces tape, etc.</p> </div> <ol style="list-style-type: none"> 4) Turn the drain cap once again to OPEN → direction to remove it. <p>2. Attachment</p> <ol style="list-style-type: none"> 1) Insert the drain cap (inside), turn it to CLOSE → direction until the position where “Clashed sound” is heard and it cannot be turned more over (Position where △ mark of the drain pan matches with △ mark of the drain cap (inside)) and then fix it. <div style="border: 1px solid black; padding: 5px; margin: 10px 0;"> <p>NOTE : When attaching the drain cap (inside), remove dirt attached to the packing. And tighten in it noting so that the cap is not slantingly set. If attaching the drain cap as dust or dirt is attached or the cap is set slantingly, water leakage is caused.</p> </div> <ol style="list-style-type: none"> 2) Turn the drain cap (outside) to → direction and then attach it using the fixing screw as original. 3) Following to work of item 2 of ① , mount the suction grille as before. 	 

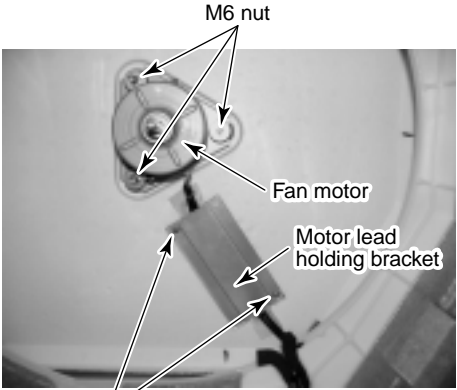
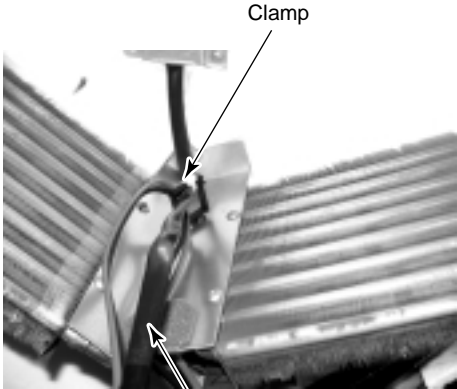
No.	Part name	Procedure	Remarks
⑦	Fan motor	<p>1. Detachment</p> <ol style="list-style-type: none"> 1) Carry out work of item 1 of ②. 2) Remove connectors which are connected from the control P.C. board to the other parts and then remove each wiring from the clamp. CN510 : Louver motor (20P, White) CN34 : Float switch (3P, Red) CN504 : Drain pump (2P, White) CN100 : TC1 sensor (3P, Brown) CN101 : TC2 sensor (2P, Black) CN102 : TCJ sensor (2P, Red) CN104 : Room temp. Sensor (2P, Yellow) CN333 : Fan motor power supply (5P, White) CN334 : Fan motor position detection (3P, White) CN82 : PMV (6P, Blue) <div style="border: 1px solid black; padding: 5px; margin: 10px 0;"> <p>NOTE : Unlock the lock of the housing part and then remove the connector.</p> </div> <ol style="list-style-type: none"> 3) Remove the fixing screws A and B, and then remove the electric parts box. (Fixing screw A: $\varnothing 4 \times 10$, 3 pcs, Fixing screw B: $\varnothing 4 \times 8$, 1 pc.) 4) Remove the fan motor lead, TC sensor and TCJ sensor from clamp of the bell mouth. 5) Remove the fixing screws and then remove the bell mouth. ($\varnothing 4 \times 10$, 8 pcs.) 6) Remove the fixing screws and then remove the nut cap. ($\varnothing 4 \times 10$, 2 pcs.) 7) Remove the fixing nut and then remove the turbo fan. (M8 nut with flange, 1 pc.) 8) Remove the fixing screws and then remove the motor lead holding bracket. ($\varnothing 4 \times 8$, 2 pcs.) 9) Cut the bundling band and then remove it from the clamp. 10) Remove the fixing nut and then remove the fan motor. ($\varnothing 6$ nut, 3 pcs.) <p>2. Attachment</p> <ol style="list-style-type: none"> 1) Fix the parts as before in order of fan motor → motor lead holding bracket → turbo fan → nut cap → bell mouth. <div style="border: 1px solid black; padding: 5px; margin: 10px 0;"> <p>NOTE : Fix the motor lead to the clamp without slack as before using bundling band. When fixing the turbo fan, be sure to match the D-cut of the fan boss with D-cut of the motor shaft. Using a torque wrench, fix the turbo fan and tighten it to $5.4^{+0.5}_{-0.2}$ Nm. Using torque wrench, fix the fan motor (at 3 positions) and tighten it to $4.9^{+0.5}_{-0.2}$ Nm.</p> </div>	<p style="text-align: center;">Remarks</p>  <p style="text-align: center;">Electric parts box</p>  <p style="text-align: center;">Clamp</p> <p style="text-align: center;">Fan motor lead TC sensor TCJ sensor</p>  <p style="text-align: center;">Bell mouth Nut cap</p>  <p style="text-align: center;">Fixing screw</p>  <p style="text-align: center;">Turbo fan</p>  <p style="text-align: center;">M8 nut with flange</p>

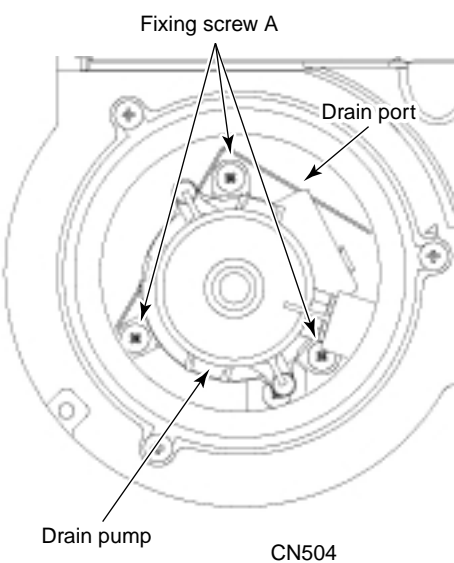
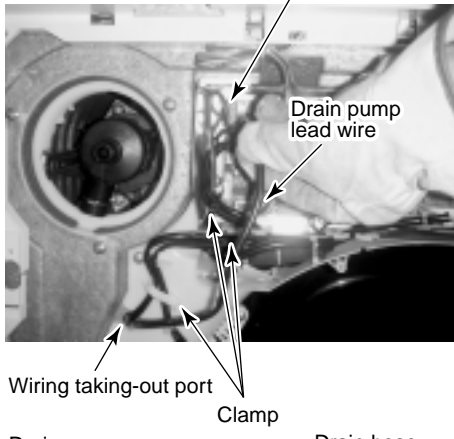
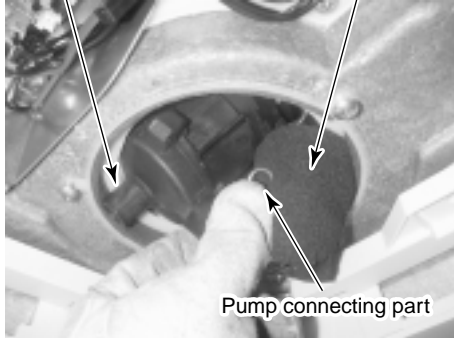
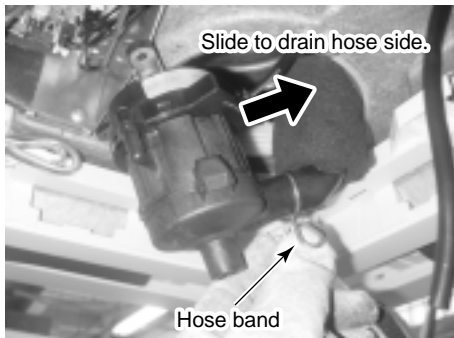
No.	Part name	Procedure	Remarks
⑦	Fan motor (Continued)	<p>2. Attachment</p> <p>2) Fix the fan motor lead, TC sensor and TCJ sensor with the clamp of the bell mouth.</p> <p>3) Mount the electric parts box with the fixing screws A and B. ($\varnothing 4 \times 10$, 3 pcs. $\varnothing 4 \times 8$, 1 pc.)</p> <p>4) Connect the connector removed in item 1 as before and then fix wiring with the clamp.</p> <p>5) Following to work of item 2 of ②, mount the electric parts box cover and the suction grille as before.</p> <hr/> <p style="text-align: center;">CAUTION</p> <hr/> <p>When exchanging the fan motors of the models MMU-AP0092H to AP0320H, take off lead wire from the clamp filter, which is connected to CN334 of the fan motor to be exchanged and then connect the removed lead wire to a new fan motor.</p> <hr/>	 <p>M6 nut</p> <p>Fan motor</p> <p>Motor lead holding bracket</p> <p>Fixing screws ($\varnothing 4 \times 8$)</p>  <p>Clamp</p> <p>Fan motor lead</p>

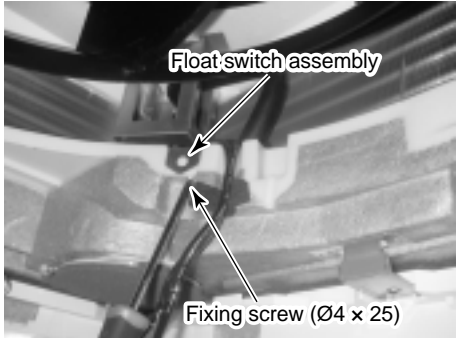
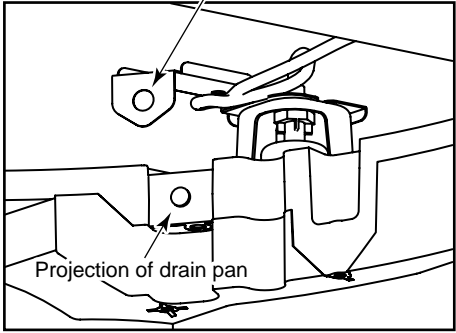
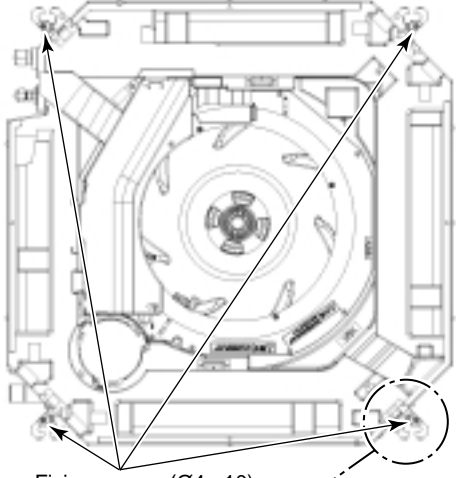
No.	Part name	Procedure	Remarks
⑧	Drain pump	<p>1. Detachment</p> <ol style="list-style-type: none"> 1) Carry out works of item 1 of ② and item 1 of ⑥. 2) Remove the drain pump connector (CN504, White, 2P) connected to the control P.C. board and then remove the lead wire from the clamp. 3) Remove the fixing screws and then remove the drain pump. (Ø4 × 10, 3 pcs.) 4) As shown in the right figure, first pull out the connecting part of the drain pump and the drain hose from the drain port and then take out the drain pump. 5) Set direction of the knob of the hose band downward, slide it from the pump connecting part to the hose side and then remove the drain hose from the drain pump. 6) Pass the connector of the drain pump lead wire through the wiring taking-out port and then take out the drain pump. <p>2. Attachment</p> <ol style="list-style-type: none"> 1) Enter your hand into the drain port and pass the connector of the drain pump lead wire through the wiring taking-out port. 2) Connect the drain hose to the drain pump as before. <div style="border: 1px solid black; padding: 5px; margin: 10px 0;"> <p>NOTE : Insert the drain hose up to the end of the drain pump connecting part, apply band to the white mark position of the hose and then set the band knob upward.</p> </div> <ol style="list-style-type: none"> 3) Return the drain pump to the indoor unit and then mount it as before using the fixing screws. (Ø4 × 10, 3 pcs.) 4) Connect the drain pump connector (CN504, White, 2P) to the control P.C. board and then fix it as before with the clamp. 5) Following to words of item 2 of ⑥ and item 2 of ②, mount the drain cap, the electric parts box cover and the suction grille as before. 	   

No.	Part name	Procedure	Remarks
⑨	Float switch assembly	<p>1. Detachment</p> <ol style="list-style-type: none"> 1) Carry out works of item 1 of ⑦ and works from 1) to 5). 2) Remove the fixing screw and then remove the float switch assembly. (Ø4 × 25, 1 pc.) <p>2. Attachment</p> <ol style="list-style-type: none"> 1) Mount the float switch assembly as before with the fixing screw. <div data-bbox="386 555 922 685" style="border: 1px solid black; padding: 5px; margin: 10px 0;"> <p>NOTE : When mounting, match hole of the float switch assembly with projection of the drain pan.</p> </div> <ol style="list-style-type: none"> 2) Mount the bell mouth as before. (Ø4 × 10, 8 pcs.) 3) Following to works of item 2 of ⑦ and works from 2) to 5), attach the parts as before. 	 <p style="text-align: center;">Hole of float switch assembly</p> 
⑩	Drain pan	<p>1. Detachment</p> <ol style="list-style-type: none"> 1) Carry out works of item 1 of ④, item 1 of ⑥, item 1 of ⑦ and works from 2) to 5). 2) Remove the fixing screws to remove the drain pan. (Ø4 × 10, 4 pcs.) <p>2. Attachment</p> <ol style="list-style-type: none"> 1) Fix parts as before in order of drain cap → drain pan → bell mouth. 2) Following to works of item 2 of ⑦ and works from 2) to 5), attach parts as before. 	 <div data-bbox="986 1639 1423 1989" style="border: 1px dashed black; padding: 5px; margin: 10px 0;">  </div>

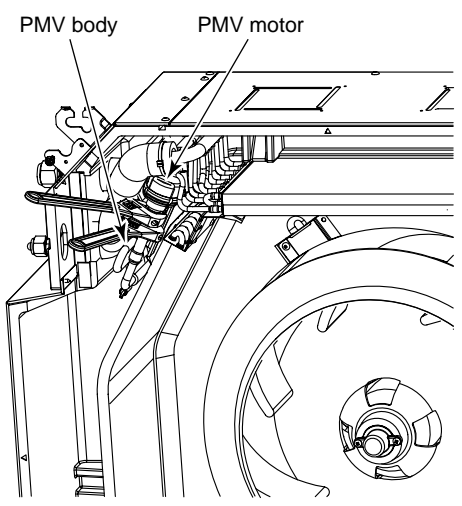
No.	Part name	Procedure	Remarks
⑪	PMV motor	<p>1. Detachment</p> <ol style="list-style-type: none"> 1) Carry out work of item 1 of ⑩ . 2) Remove the relay connector of PMV motor. 3) Peel the butyl rubber adhered to the main unit of the pulse motor valve (PMV) until PMV can be seen and then loosen the nuts fixing PMV motor with double spanner to remove PMV motor. <p>2. Attachment</p> <ol style="list-style-type: none"> 1) Mount PMV motor and relay connector as before. <div style="border: 1px solid black; padding: 5px; margin-top: 10px;"> <p>NOTE : Control the tightening torque for the PMV body and PMV motor to $7.84 \pm 0.98\text{Nm}$.</p> </div>	

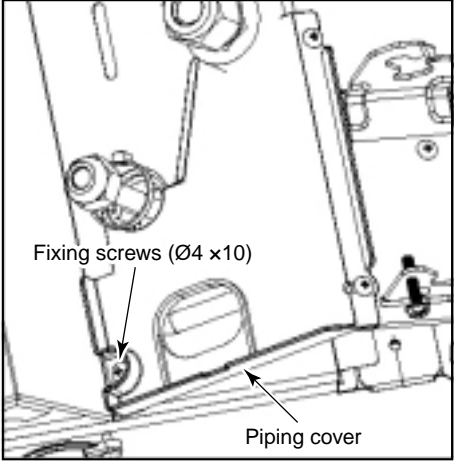
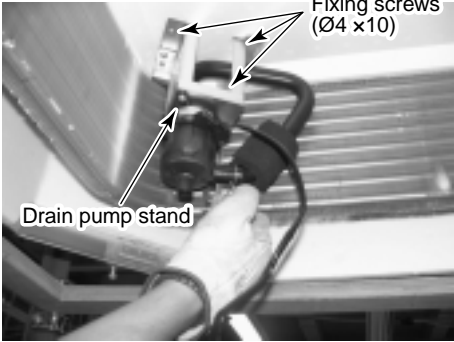
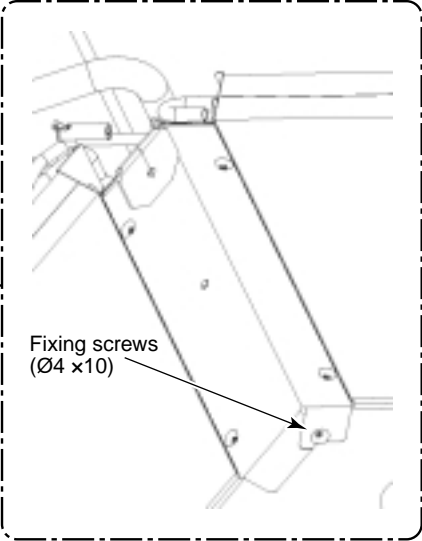
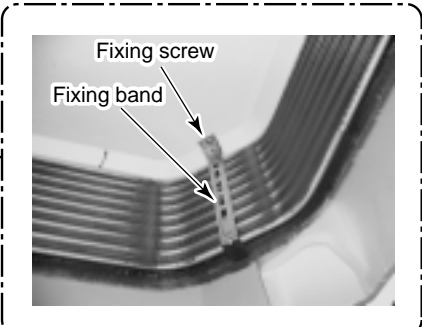
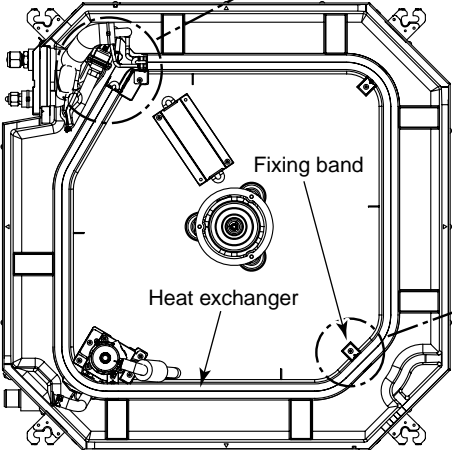
No.	Part name	Procedure	Remarks
⑫	Heat exchanger	<p>1. Detachment</p> <ol style="list-style-type: none"> 1) Recover the refrigerant gas. 2) Carry out work of item 1 of ⑩. 3) Remove refrigerant pipe at indoor unit side. 4) Remove the fixing screws and then remove the piping cover. (Ø4 x10, 3 pcs.) 5) Remove the drain hose from the drain pump and remove the fixing screws to remove the drain pump stand. (Ø4 x8, 3 pcs.) 6) While pushing the heat exchanger, remove the fixing band, fixing screws and the heat exchanger. (Ø4 x8, 3 pcs.) <p>2. Attachment</p> <ol style="list-style-type: none"> 1) Mount the heat exchanger with the fixing band and the fixing screws. (Ø4 x8, 3 pcs.) 2) Fix the parts as before in order of drain pump stand → piping cover. 3) Connect the refrigerant pipe as before and then apply vacuuming. 4) Following to work of item 2 of ⑩, attach the parts as before. 	 <p>Fixing screws (Ø4 x10)</p> <p>Piping cover</p>  <p>Fixing screws (Ø4 x10)</p> <p>Drain pump stand</p>  <p>Fixing screws (Ø4 x10)</p>  <p>Fixing screw</p> <p>Fixing band</p>  <p>Fixing band</p> <p>Heat exchanger</p>

11. P.C. BOARD EXCHANGE PROCEDURES

11-1. Exchange of P.C. Board for Indoor Service

Part code	Models	P.C. board
431-6V-379	MMU-AP *** 2H series	MCC-1570

CAUTION

<Model Name: MMU-AP *** 2H>

For the above models, set the CODE No. to “LE” and the setting data 0000 (initial) to “0001”

<Note: when replacing the P.C. board for indoor unit servicing>

The nonvolatile memory (hereafter called EEPROM, IC503) on the indoor unit P.C. board before replacement includes the model specific type information and capacity codes as the factory-set value and the important setting data which have been automatically or manually set when the indoor unit is installed, such as system/indoor/group addresses, high ceiling select setting, etc. When replacing the P.C. board for indoor unit servicing, follow the procedures below.

After replacement completes, confirm whether the settings are correct by checking the indoor unit No., Group header unit/follower unit settings and perform the cooling cycle confirmation through the trial operation.

<Replacement procedures>

Case 1

Before replacement, the indoor unit can be turned on and the setting data can be read out by wired remote controller operation.

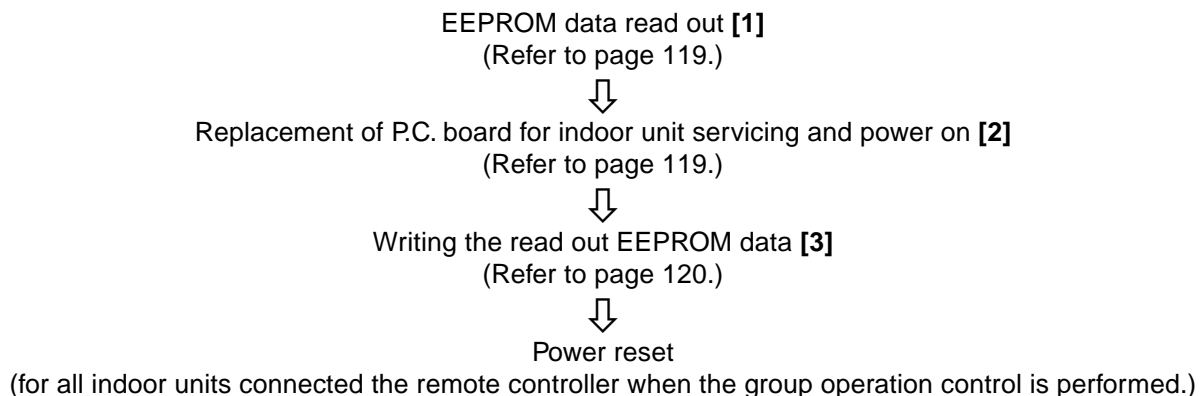

Case 2

The EEPROM before replacement is defective and the setting data cannot be read out.

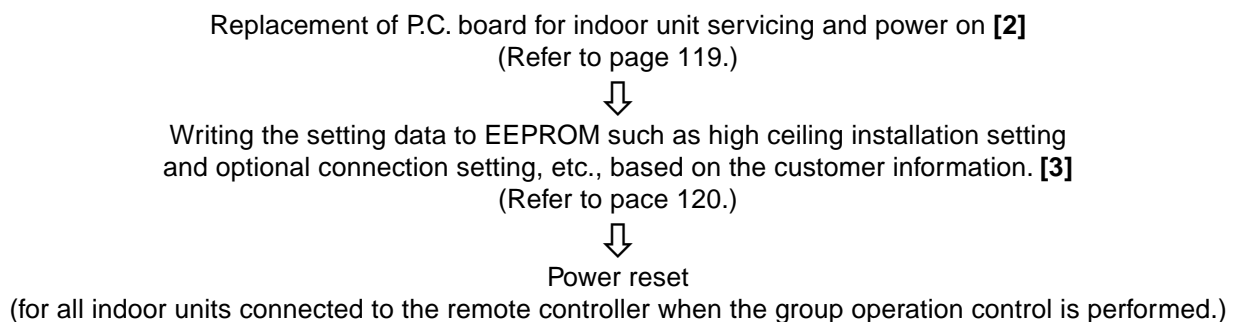

[1] Setting data read out from EEPROM

The setting data modified on the site, other than factory-set value, stored in the EEPROM shall be read out.

Step 1 Push SET , CL and TEST buttons on the remote controller simultaneously for more than 4 seconds.

* When the group operation control is performed, the unit No. displayed for the first time is the header unit No. At this time, the CODE No. (DN) shows “/0”. Also, the fan of the indoor unit selected starts its operation and the swing operation also starts if it has the louvers.

Step 2 Every time when the UNIT LOUVER button is pushed, the indoor unit No. under the group control is displayed in order. Specify the indoor unit No. to be replaced.

1. Change the CODE No. (DN) from /0 to 0/ by pushing ▼ / ▲ buttons for the temperature setting. (This is the setting for the filter sign lighting time.)
At this time, be sure to write down the setting data displayed.

2. Change the CODE No. (DN) by pushing ▼ / ▲ buttons for the temperature setting. Similarly, be sure to write down the setting data displayed.

3. Repeat the step 2-2 to set the other settings in the same way and write down the setting data as shown in the table 1 (example) on page 122.

• The CODE No. (DN) are ranged from “0/” to “FF”. The CODE No. (DN) may skip.

Step 3 After writing down all setting data, push TEST button to return to the normal stop status. (It takes approx. 1 min until the remote controller operation is available again.)

CODE No. required at least

DN	Contents
10	Type
11	Indoor unit capacity
12	System address
13	Indoor unit address
14	Group address

1. The CODE No. for the Indoor unit type and Indoor unit capacity are required to set the rotation number setting of the fan.
2. If the system/indoor/group addresses are different from those before replacement, the auto-address setting mode starts and the manual resetting may be required again.
(When the multiple units group operation including twin system)

[2] P.C. Board for indoor unit servicing replacement procedures

Step 1 Replace the P.C. board for indoor unit servicing.

At this time, perform the same setting of the jumper wire (J01) setting (cut), switch SW501 (short-circuit) connector CN34 as the setting of the P.C. board before replacement.

Step 2 It is necessary to set indoor unit to be exchanged: Remote controller = 1 : 1

Based upon the system configuration, turn on power of the indoor unit with one of the following items.

1) Single (Individual) operation. Turn on power of the indoor units and proceed to [3].

2) Group operation

A) In case that power of the exchanged indoor unit only can be turned on
Turn on power of the exchanger indoor unit only and proceed to [3].

B) In case that power of the indoor units cannot be turned on individually (**Case 1**)

a) Remove temporarily the group wire connected to the terminal blocks A and B of the exchanged indoor unit.

b) After connecting the remote controller wire only to the removed terminal block, turn on power of the indoor units and proceed to [3].

* When the above methods cannot be used, follow to the two cases below.

C) In case that power of the indoor units cannot be turned in individually (**Case 2**)

a) Remove all CN41 connectors of the indoor units in the same group except those of the exchanged indoor unit.

b) Turn on power of the indoor units and proceed to [3].

* After [3] operation has finished, be sure to return the temporarily removed group wire or CN41 connector to the original connection.

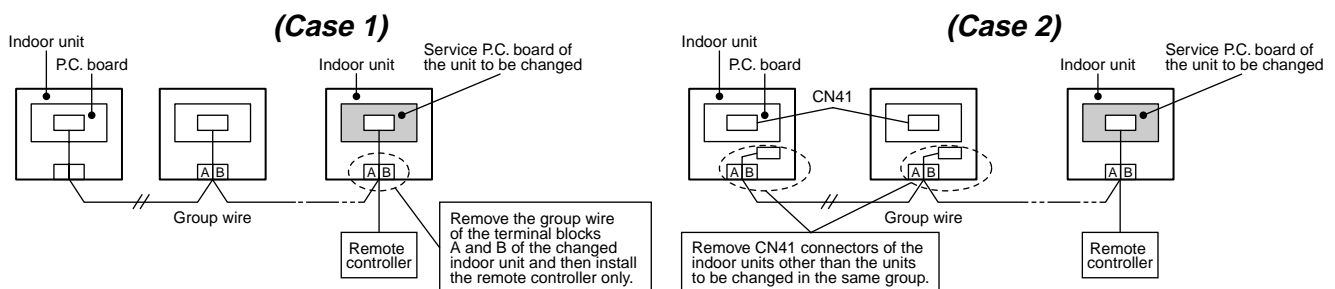

[3] Wiring the setting data to EEPROM

The settings stored in the EEPROM of the P.C. board for indoor unit servicing are the factory-set values.

- Step 1** Push **SET**, **CL** and **TEST** buttons on the remote controller simultaneously for more than 4 seconds. **1**
- * In the group control operation, the unit No. displayed for the first time is the header unit No.
(**ALL** is displayed in the Unit No. box.)
- At this time, the CODE No. (DN) shows " / 0 ". Also, the fan of the indoor unit selected starts its operation and the swing operation starts if it has the louvers.
- Step 2** Every time when the **UNIT LOUVER** button is pushed, the indoor unit Nos. in the group control operation are displayed in order. **2** (The settings stored in the EEPROM of the P.C. board for indoor unit servicing are the factory-set values.) Specify the indoor unit No. with its P.C. board replaced to the P.C. board for indoor unit servicing.
- Step 3** Select the CODE No. (DN) can be selected by pushing the **▼** / **▲** button for the temperature setting. **3**
- Set the indoor unit type and capacity.
- The factory-set values shall be written to the EEPROM by changing the type and capacity.
1. Set the CODE No. (DN) to " / 0 ". (without change)
 2. Select the type by pushing **▼** / **▲** buttons for the timer setting. **4** (For example, 4-way Air Discharge Cassette Type is set to "0001". Refer to Item code [10] on page 122.)
 3. Push **SET** button. (The operation completes if the setting data is displayed.) **5**
 4. Change the CODE No. (DN) to " / / " by pushing **▼** / **▲** buttons for the temperature setting. **3**
 5. Select the capacity by pushing **▼** / **▲** buttons for the timer setting. **4**
(For example, 027 Type is set to "0012". Refer to Item code [11] on page 6.)
 6. Push **SET** button. (The setting completes if the setting data are displayed.) **5**

<Fig. 1 RBC-AMT32E>

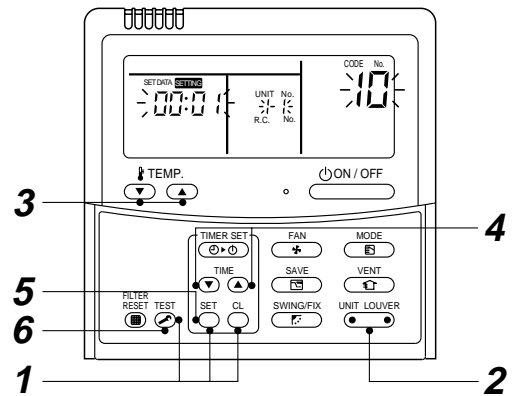

<Fig. 2 RBC-AMS41E>

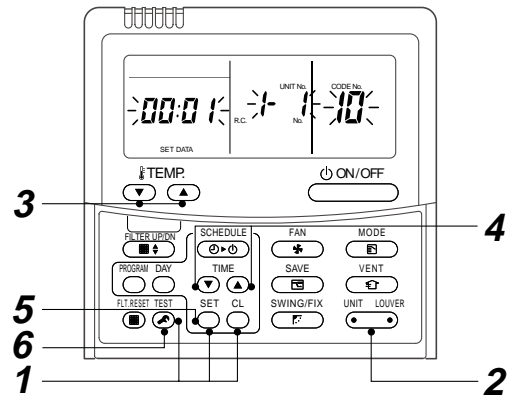

Setting 4-way Air Discharge Cassette indoor unit model only

7. Using the set temperature **▼** / **▲** buttons, set " / E " to the CODE No. (DN).
8. Using the timer time **▼** / **▲** buttons, set the dat. (0001)
9. Push **SET** button (The setting completes if the setting data are displayed.)

⚠ CAUTION

Be sure to set the jumper wire since the motor protection level setting selection is preformed on it.

If the plug short-circuit is attached on the P.C. board before replacement, attach it on the P.C. board replaced.

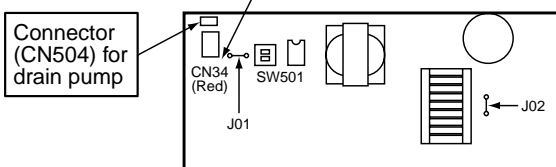

* Set J02 as follows depending on the capacity class.

	Jumper wire (J02)
AP009 to AP030 type	None
AP036 to AP056 type	Required (Factory setting)

10. Push the **TEST** button to return to the normal stop status
(It takes approx. 1 min until the remote control operation is available again.)

- Step 4** Write the on-site setting data to the EEPROM such as address setting, etc. Perform the steps 1 and 2 above again.
- Step 5** Change the CODE No. (DN) to " / / " by pushing **▼** / **▲** buttons for the temperature setting. (This is the setting for the filter sign lighting time.)

- Step 6** Check the setting data displayed at this time with the setting data down in **[1]** (on page 122).
1. If the setting data is different, modify the setting data by pushing \blacktriangledown / \blacktriangle buttons for the timer setting to the data put down in **[1]**. The operation completes if the setting data is displayed.
 2. If the data is the same, proceed to next step.
- Step 7** Change the CODE No. (DN) by pushing \blacktriangledown / \blacktriangle buttons for the temperature setting. As described above, check the setting data and modify to the data put down in **[1]**.
- Step 8** Repeat the steps 6 and 7.
- Step 9** After the setting completes, push TEST button to return to the normal stop status. **6**
- In a group operation, turn off the power supply once, return the group wires between indoor units and CN41 connectors as before, and then turn on power of all the indoor unit. (It takes approx. 1 min until the remote controller operation is available again.)
- The CODE No. (DN) are ranged from “01” to “FF”. The CODE No. (DN) is not limited to be serial No. Even after modifying the data wrongly and pushing SET button, it is possible to return to the data before modification by pushing CL button if the CODE No. (DN) is not changed.

<Fig.3 EEPROM layout diagram>

The EEPROM (IC503) is attached to the IC socket.

When detaching the EEPROM, use a tweezers, etc.

Be sure to attach the EEPROM by fitting its direction as shown in the figure.

* Do not bend the IC lead when replacing.

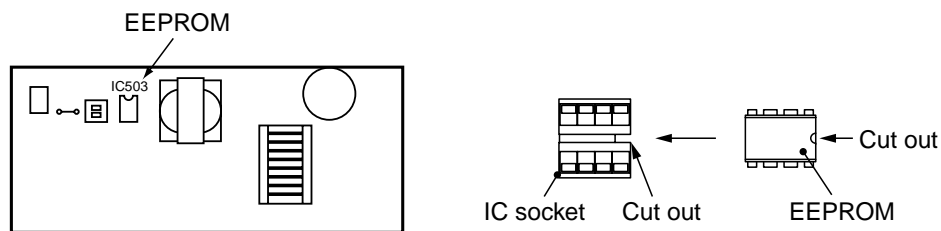

<Fig. 3>

<Make a note of the setup contents. (Item code list (Example))>

DN	Item	Setting data	Factory-set value
01	Filter sign lighting time		Depending on Type
02	Filter pollution leve		0000: standard
03	Central control address		0099: Not determined
06	Heating suction temperature shift		0002: +2°C (flooring installation type: 0)
0d	Existence of automatic COOL/HEAT mode		0001: No auto mode cooling/heating
0F	Cooling only		0000: Heat pump
10	Type		Depending on model type
11	Indoor unit capacity		Depending on capacity type
12	System address		0099: Not determined
13	Indoor unit address		0099: Not determined
14	Group address		0099: Not determined
19	Louver type (wind direction adjustment)		Depending on Type.
1E	Temperature range of cooling/heating automatic SW control point		0003: 3 deg (Ts ± 1.5)
28	Power failure automatic recovery		0000: None
2A	Option/Abnormal input (CN70) SW		0002: Humidifier
31	Ventilation fan (standalone)		0000: Not available
32	Sensor SW (Selection of static pressure)		0000: Body sensor
5d	High ceiling SW		0000: Standard
60	Timer setting (wired remote controller)		0000: Available
F0	Swing mode		0001: Standard
F1	Louver fixing position (Flap No. 1)		0000: Not fixed
F2	Louver fixing position (Flap No. 2)		0000: Not fixed
F3	Louver fixing position (Flap No. 3)		0000: Not fixed
F4	Louver fixing position (Flap No. 4)		0000: Not fixed

Type
Item code [10]

Setup data	Type	Model abb. name
0000	1-way Air Discharge Cassette	MMU-AP***SH
0001 *1, *2	4-way Air Discharge Cassette	MMU-AP***2H
0002	2-way Air Discharge Cassette	MMU-AP***WH
0003	1-way Air Discharge Cassette (Compact type)	MMU-AP***YH
0004	Concealed Duct Standard	MMD-AP***BH
0005	Slim Duct	MMD-AP***SPH MMD-AP***SH
0006	Concealed Duct High Static Pressure	MMD-AP***H
0007	Under Ceiling	MMC-AP***H
0008	High Wall	MMK-AP***H
0009	—	—
0010	Floor Standing Cabinet	MML-AP***H
0011	Floor Standing Concealed	MML-AP***BH
0012	—	—
0013	Floor Standing (Below 6HP)	MMF-AP***H
0014	Compact 4-way Air Discharge Cassette	MMU-AP***MH

Indoor unit capacity
Item code [11]

Setup data	Model	Setup data	Model
0000*	Invalid	0016	—
0001	007 type	0017	048 type
0002	—	0018	056 type
0003	009 type	0019	—
0004	—	0020	—
0005	012 type	0021	072 type
0006	—	0022	—
0007	015 type	0023	096 type
0008	—	0024	—
0009	018 type	0025	—
0010	—	0026	—
0011	024 type	0027	—
0012	027 type	0028	—
0013	030 type	~	—
0014	—	0034	—
0015	036 type		

*1 The initial setup value of EEPROM installed on the service P.C. board

*2 <Model Name: **MMU-AP *** 2H**>

For the above models, set CODE No. to “**LE**” and the setting data 0000 (initial) to “0001”.

12. EXPLODED VIEWS AND PARTS LIST

MMU-AP0092H, AP0122H, AP0152H, AP0182H, AP0242H

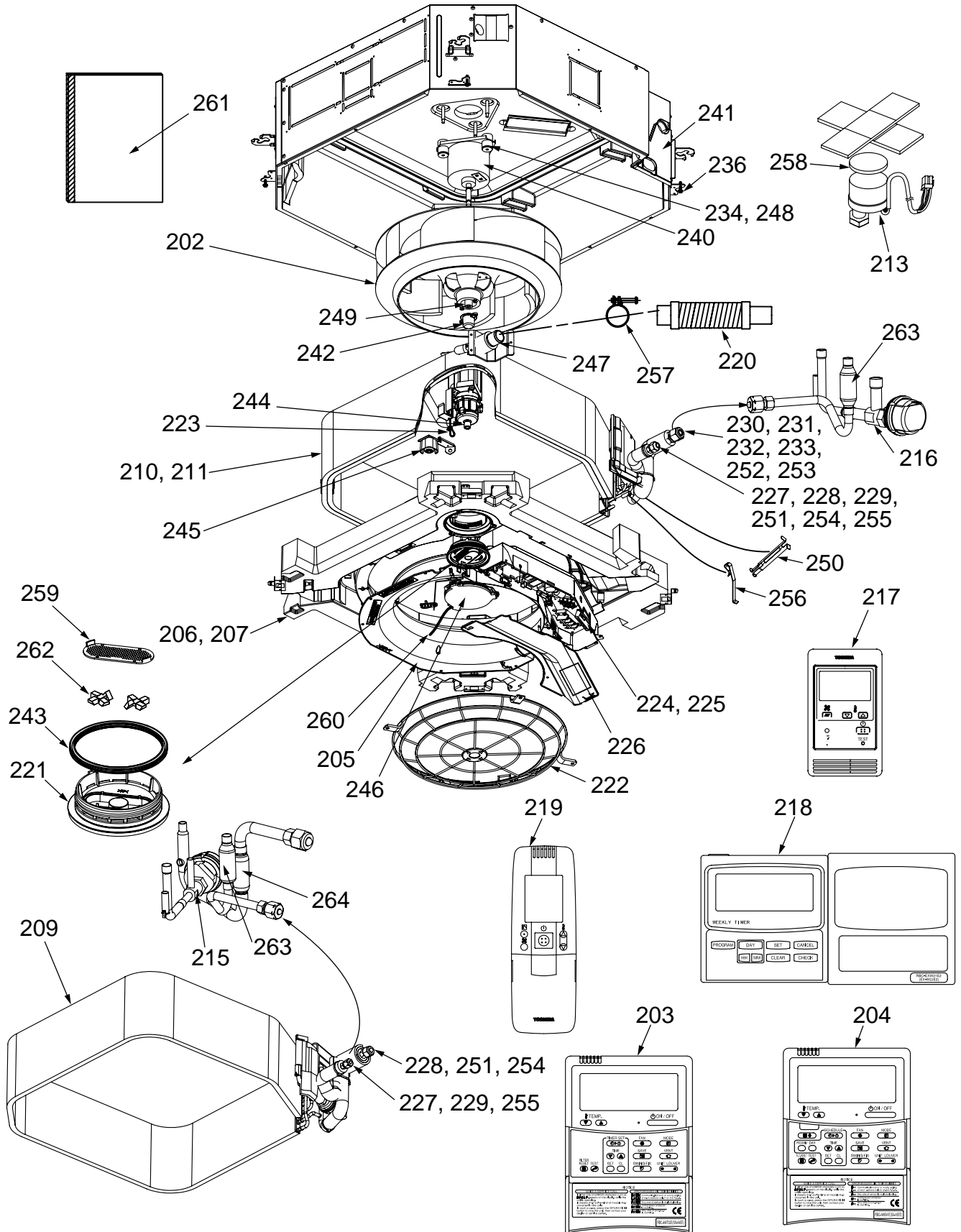

Location No.	Parts No.	Description	Model Name MMU-AP				
			0092H	0122H	0152H	0182H	0242H
202	43120248	Fan Ass'y, Turbo	1	1	1	1	1
203	43166011	Remote Controller	1	1	1	1	1
204	43166012	Remote Controller	1	1	1	1	1
205	43122110	Bell Mouth	1	1	1	1	1
206	43172206	Pan Ass'y, Drain			1	1	1
207	43172207	Pan Ass'y, Drain	1	1			
209	4314J405	Refrigeration Cycle Ass'y	1	1			
210	4314J406	Refrigeration Cycle Ass'y			1	1	
211	4314J407	Refrigeration Cycle Ass'y					1
213	43146707	Motor, PMV, EDM-MD12TF-3	1	1	1	1	1
215	43146713	Valve, PMV, EDM-B25YGTF-3	1	1			
216	43146714	Valve, PMV, EDM-B40YGTF-3			1	1	1
217	43166004	Remote Controller, SX-A11JE2	1	1	1	1	1
218	43166005	Remote Controller, EX-W2JE2	1	1	1	1	1
219	43166006	Remote Controller, WH-H1JE2	1	1	1	1	1
220	43170244	Hose, Drain	1	1	1	1	1
221	43179144	Lid, Inside	1	1	1	1	1
222	43119499	Guard, Fan	1	1	1	1	1
223	43079249	Band, Hose	1	1	1	1	1
224	43163057	Clamp, Down	1	1	1	1	1
225	43163058	Clamp, Up	1	1	1	1	1
226	43089147	Clamp, Wire	4	4	4	4	4
227	43047685	Nut, Flare, 1/4, IN	1	1	1	1	
228	43049776	Socket, 3/8, IN	1	1			1
229	43149351	Socket, 1/4, IN	1	1			
230	43047688	Nut, Flare, 1/2, IN			1	1	
231	43149352	Nut, Flare, 5/8, IN					1
232	43149353	Socket, 1/2, IN					1
233	43149354	Socket, 5/8, IN	3	3	3	3	3
234	43139137	Rubber, Cushion	4	4	4	4	4
236	43197197	Screw, Fix Panel	1	1	1	1	1
240	4312C039	Motor, Fan	1	1	1	1	1
241	43119497	Cover Ass'y	1	1	1	1	1
242	43139166	Cap, Nut	1	1	1	1	1
243	43179147	Gasket	1	1	1	1	1
244	43177010	Pump Ass'y, MDP-1401	1	1	1	1	1
245	43151299	Switch Ass'y, Float, FS-0218-102	1	1	1	1	1
246	43179145	Lid Ass'y, Outside	1	1	1	1	1
247	43170254	Socket Ass'y, Drain	1	1	1	1	1
248	43197155	Washer	3	3	3	3	3
249	43097212	Nut	1	1	1	1	1
250	43107215	Holder, Sensor	1	1	1	1	1
251	43047609	Bonnet	1	1			1
252	43147195	Bonnet, 1/2, IN			1	1	
253	43194029	Bonnet					1
254	43149355	Nut, Flare, 3/8, IN	1	1			1
255	43049697	Bonnet	1	1	1	1	
256	43019904	Holder, Sensor	2	2	2	2	2
257	43179135	Band, Hose	1	1	1	1	1
258	43149314	Sheet, PMV	1	1	1	1	1
259	43179146	Cover, Glass	1	1	1	1	1
260	43182010	String	1	1	1	1	1
261	4311M422	Owner's Manual	1	1	1	1	1
262	43179152	Glass	1	1	1	1	1
263	43147664	Strainer	1	1	1	1	1
264	4314Q051	Strainer	1	1			

MMU-AP0092H, AP0122H, AP0152H, AP0182H, AP0242H

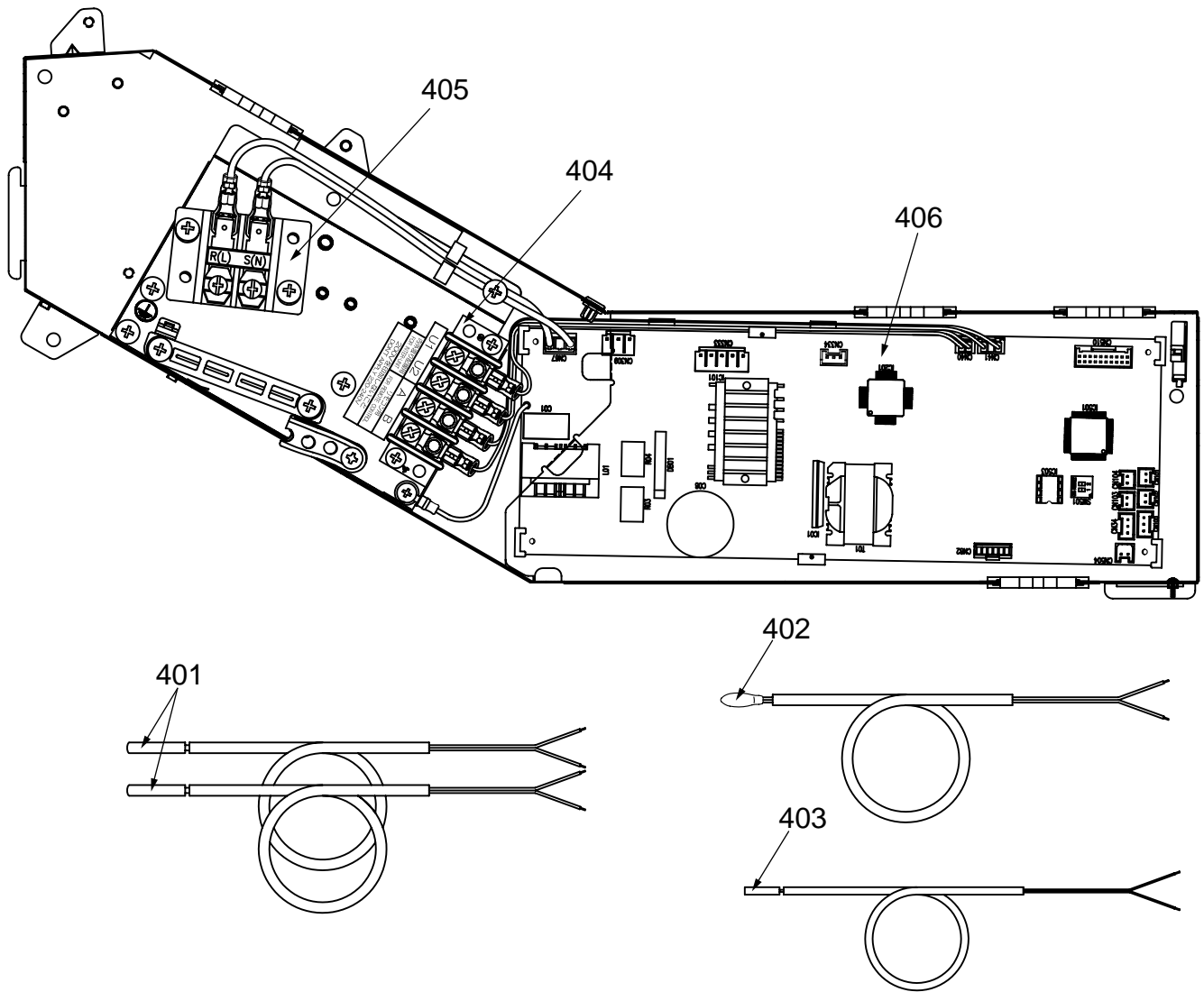

Location No.	Parts No.	Description	Model Name MMU-AP				
			0092H	0122H	0152H	0182H	0242H
401	43050425	Sensor Ass'y, Service, TC (F6)	2	2	2	2	2
402	43050426	Sensor, Service, TA	1	1	1	1	1
403	43150320	Sensor Ass'y, Service, TG (F4)	1	1	1	1	1
404	43160574	Terminal, 4P	1	1	1	1	1
405	43160575	Terminal Block, 2P, 20A	1	1	1	1	1
406	4316V379	P.C. Board Ass'y, MCC-1570	1	1	1	1	1

MMU-AP0272H, AP0302H, AP0362H, AP0482H, AP0562H

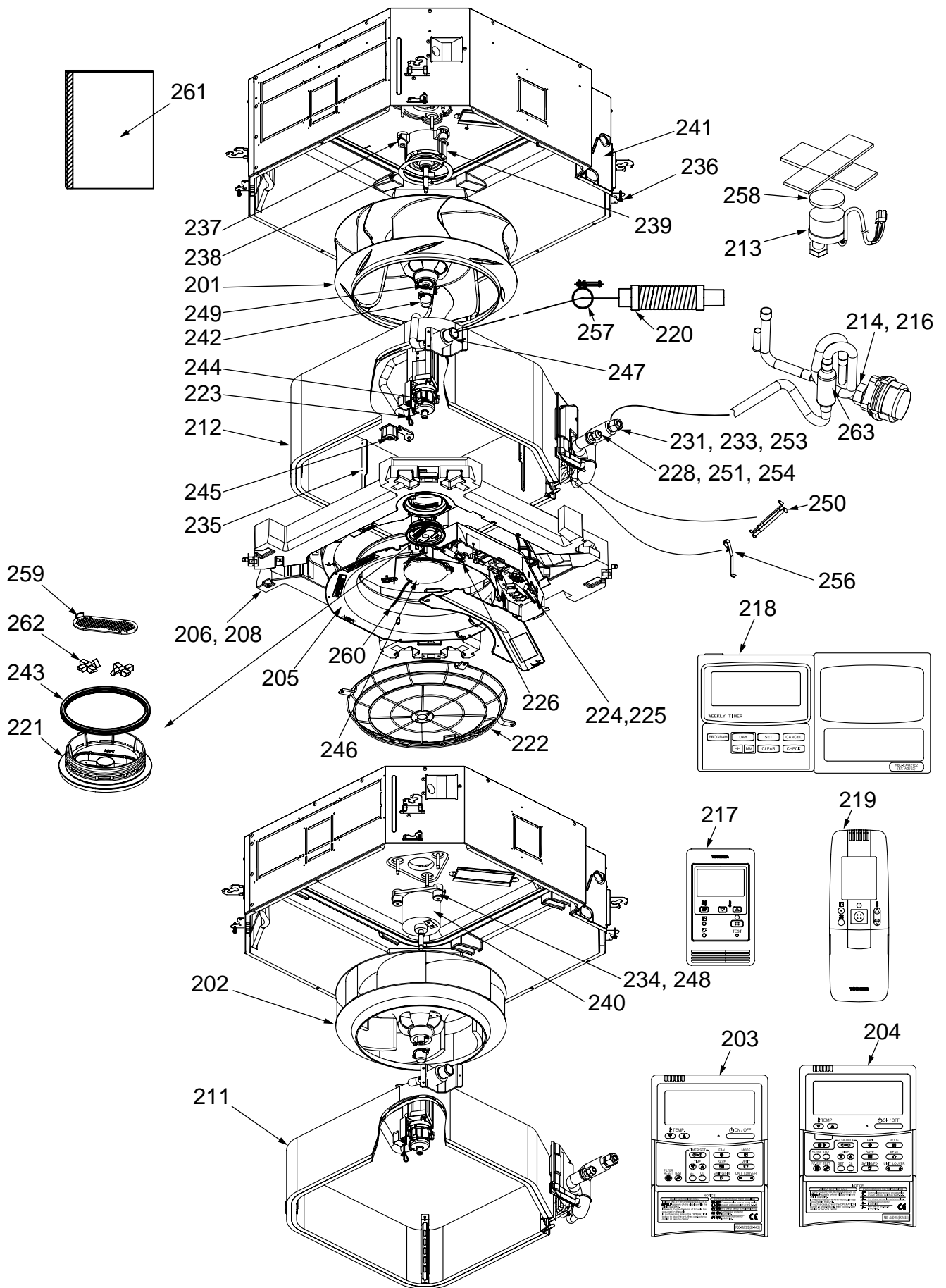

Location No.	Parts No.	Description	Model Name MMU-AP				
			0272H	0302H	0362H	0482H	0562H
201	43120247	Fan Ass'y, Turbo			1	1	1
202	43120248	Fan Ass'y, Turbo	1	1			
203	43166011	Remote Controller, SX-A4EE	1	1	1	1	1
204	43166012	Remote Controller, SX-A5EE	1	1	1	1	1
205	43122110	Bell Mouth	1	1	1	1	1
206	43172206	Pan Ass'y, Drain	1	1			
208	43172208	Pan Ass'y, Drain			1	1	1
211	4314J407	Refrigeration Cycle Ass'y	1	1			
212	4314J408	Refrigeration Cycle Ass'y			1	1	1
213	43146707	Motor, PMV, EDM-MD12TF-3	1	1	1	1	1
214	43146723	Body, PMV			1	1	1
216	43146714	Valve, PMV, EDM-B40YGTF-3	1	1			
217	43166004	Remote Controller, SX-A11JE2	1	1	1	1	1
218	43166005	Remote Controller, EX-W2JE2	1	1	1	1	1
219	43166006	Remote Controller, WH-H1JE2	1	1	1	1	1
220	43170244	Hose, Drain	1	1	1	1	1
221	43179144	Lid, Inside	1	1	1	1	1
222	43119499	Guard, Fan	1	1	1	1	1
223	43079249	Band, Hose	1	1	1	1	1
224	43163057	Clamp, Down	1	1	1	1	1
225	43163058	Clamp, Up	1	1	1	1	1
226	43089147	Clamp, Wire	4	4	4	4	4
228	43049776	Socket, 3/8, IN	1	1	1	1	1
231	43149352	Nut, Flare, 5/8, IN	1	1	1	1	1
233	43149354	Socket, 5/8, IN	1	1	1	1	1
234	43139137	Rubber, Cushion	3	3			
235	43122117	Plate, Wind			4	4	4
236	43197197	Screw, Fix Panel	4	4	4	4	4
237	43139165	Rubber, Cushion			3	3	3
238	43197199	Washer			1	1	1
239	4312C038	Motor, Fan			1	1	1
240	4312C039	Motor, Fan	1	1			
241	43119497	Cover Ass'y	1	1	1	1	1
242	43139166	Cap, Nut	1	1	1	1	1
243	43179147	Gasket	1	1	1	1	1
244	43177010	Pump Ass'y, MDP-1401	1	1	1	1	1
245	43151299	Switch Ass'y, Float, FS-0218-102	1	1	1	1	1
246	43179145	Lid Ass'y, Outside	1	1	1	1	1
247	43170254	Socket Ass'y, Drain	1	1	1	1	1
248	43197155	Washer	3	3			
249	43097212	Nut	1	1	1	1	1
250	43107215	Holder, Sensor	1	1	1	1	1
251	42047609	Bonnet	1	1	1	1	1
253	43194029	Bonnet	1	1	1	1	1
254	43149355	Nut, Flare, 3/8, IN	1	1	1	1	1
256	43019904	Holder, Sensor	2	2	2	2	2
257	43179135	Band, Hose	1	1	1	1	1
258	43149314	Sheet, PMV	1	1	1	1	1
259	43179146	Cover, Glass	1	1	1	1	1
260	43182010	String	1	1	1	1	1
261	4311M422	Owner's Manual	1	1	1	1	1
262	43179152	Glass	1	1	1	1	1
263	43147664	Strainer	1	1	1	1	1

MMU-AP0272H, AP0302H, AP0362H, AP0482H, AP0562H

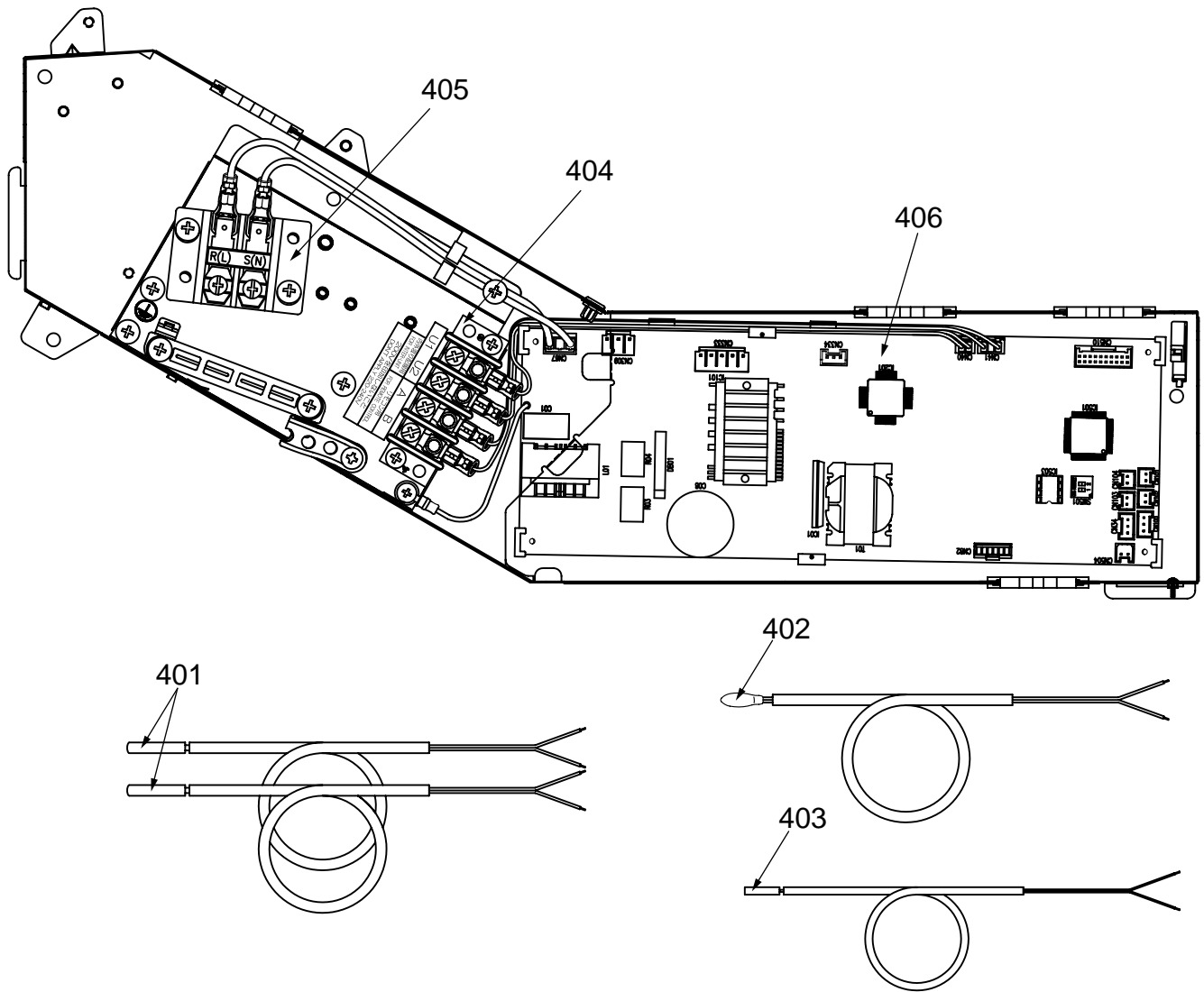

Location No.	Parts No.	Description	Model Name MMU-AP				
			0272H	0302H	0362H	0482H	0562H
401	43050425	Sensor Ass'y, Service, TC (F6)	2	2	2	2	2
402	43050426	Sensor, Service, TA	1	1	1	1	1
403	43150320	Sensor Ass'y, Service, TG (F4)	1	1	1	1	1
404	43160574	Terminal, 4P	1	1	1	1	1
405	43160575	Terminal Block, 2P, 20A	1	1	1	1	1
406	4316V379	P.C. Board Ass'y, MCC-1570	1	1	1	1	1

RBC-U31PG (W, WS)-E, RBC-U31PGS (W, WS)-E

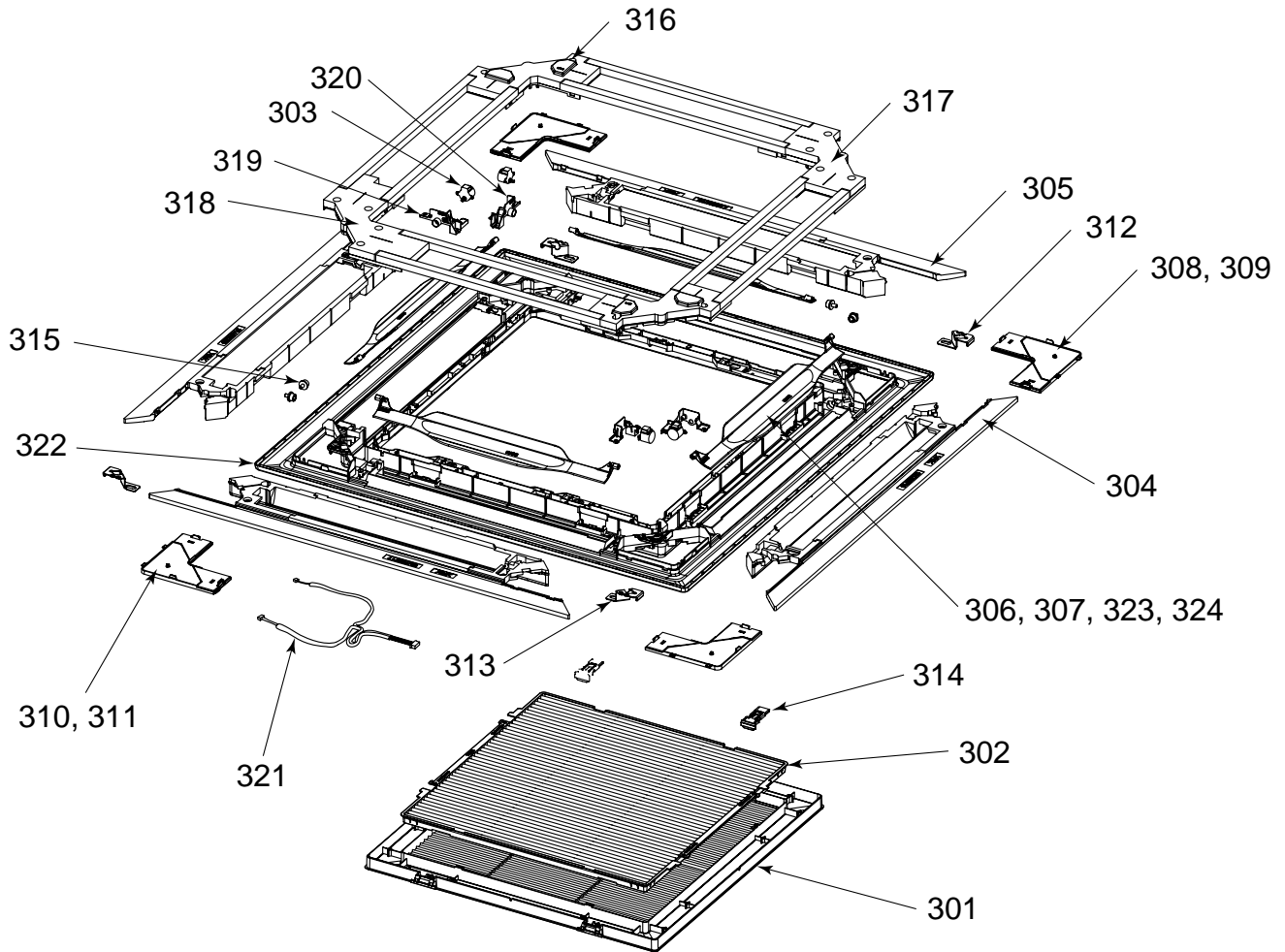

Location No.	Parts No.	Description	Model Name RBC-U31			
			U31PG(W)-E	U31PG(WS)-E	U31PGS(W)-E	U31PGS(WS)-E
301	43409207	Grille, Air Inlet	1	1	1	1
302	43480017	Air Filter, ABS + PPNET	1	1	1	1
303	4302D003	Motor, Louver, MP24Z3N	4	4	4	4
304	43407145	Outlet, Air Form, PS-F	2	2	2	2
305	43407146	Outlet, Air Form, PS-F	2	2	2	2
306	43409212	Louver, ABS	4			
307	43409216	Louver, ABS		4		
308	43401037	Cover, Panel Ass'y	3		3	
309	43401041	Cover, Panel Ass'y		3		3
310	43401043	Cover, Panel Ass'y	1		1	
311	43401047	Cover, Panel Ass'y		1		1
312	43407148	Plate, Fix, Panel	2	2	2	2
313	43407149	Plate, Fix, Panel	2	2	2	2
314	43407150	Hook, ABS	2	2	2	2
315	43407154	Cap, AXIS, POM	4	4	4	4
316	43403010	Cover Ass'y, Motor	2	2	2	2
317	43403011	Cover Ass'y	1	1	1	1
318	43403012	Cover Ass'y	1	1	1	1
319	43407155	Fix, Motor, ABS	2	2	2	2
320	43407156	Fix, Motor, ABS	2	2	2	2
321	43460125	Lead, Motor	1	1	1	1
322	43400077	Panel, Front, PS (W)	1	1	1	1
323	43109423	Louver, ABS			4	
324	43109424	Louver, ABS				4

RBC-AX31U (W)-E, RBC-AX31U (WS)-E

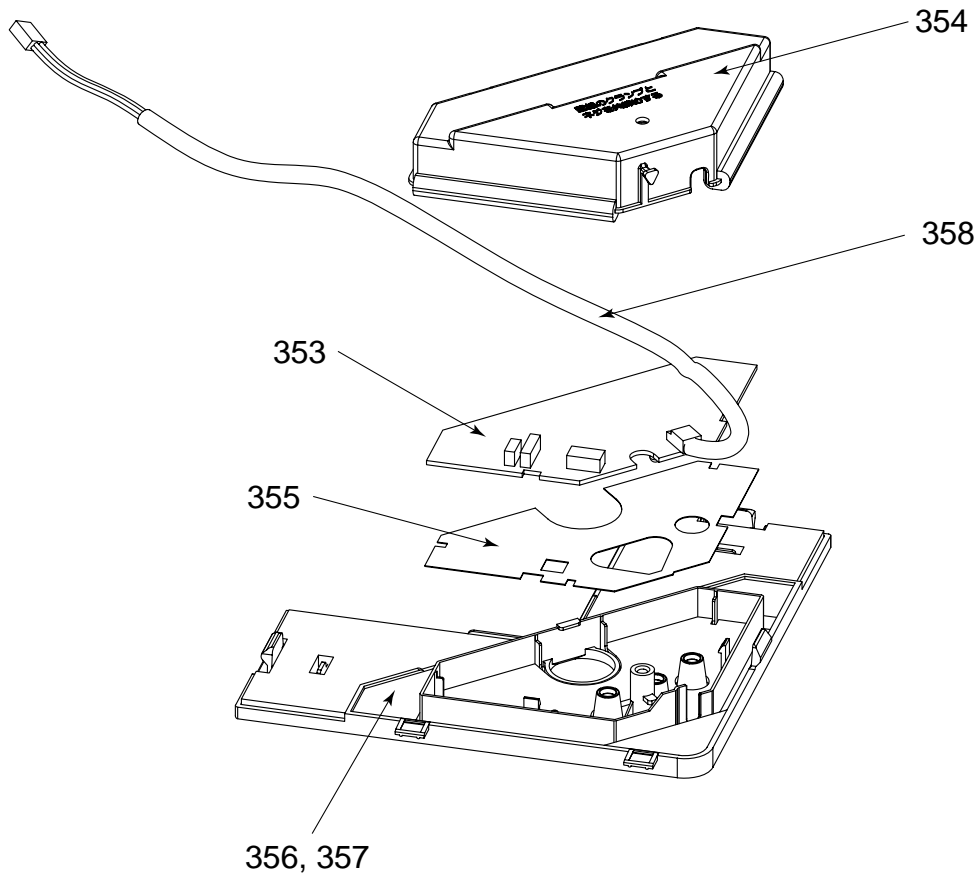

Location No.	Parts No.	Description	Model Name	
			RBC-AX31U (W)-E	RBC-AX31U (WS)-E
353	43459011	P.C. Board Ass'y, Remote Receiver	1	1
354	43462010	Cover, WRS, ABS	1	1
355	43461006	Sheet, PC	1	1
356	43108018	Cover, Panel, WRS	1	
357	43108019	Cover, Panel, WRS		1
358	43460126	Lead	1	1

TOSHIBA CARRIER CORPORATION

23-17, TAKANAWA 3 CHOME, MINATOKU, TOKYO, 108-8580, JAPAN

Copyright © 1999 to 2008 TOSHIBA CARRIER CORPORATION, ALL Rights Reserved.