

GB AUTOMATIC COFFEE MAKER
Instructions

IT MACCHINA PER CAFFÈ AUTOMATICA
Istruzioni per l'uso

NL AUTOMATISCH KOFFIEZETAPPARAAT
Gebruiksaanwijzingen

M45CAFX



A

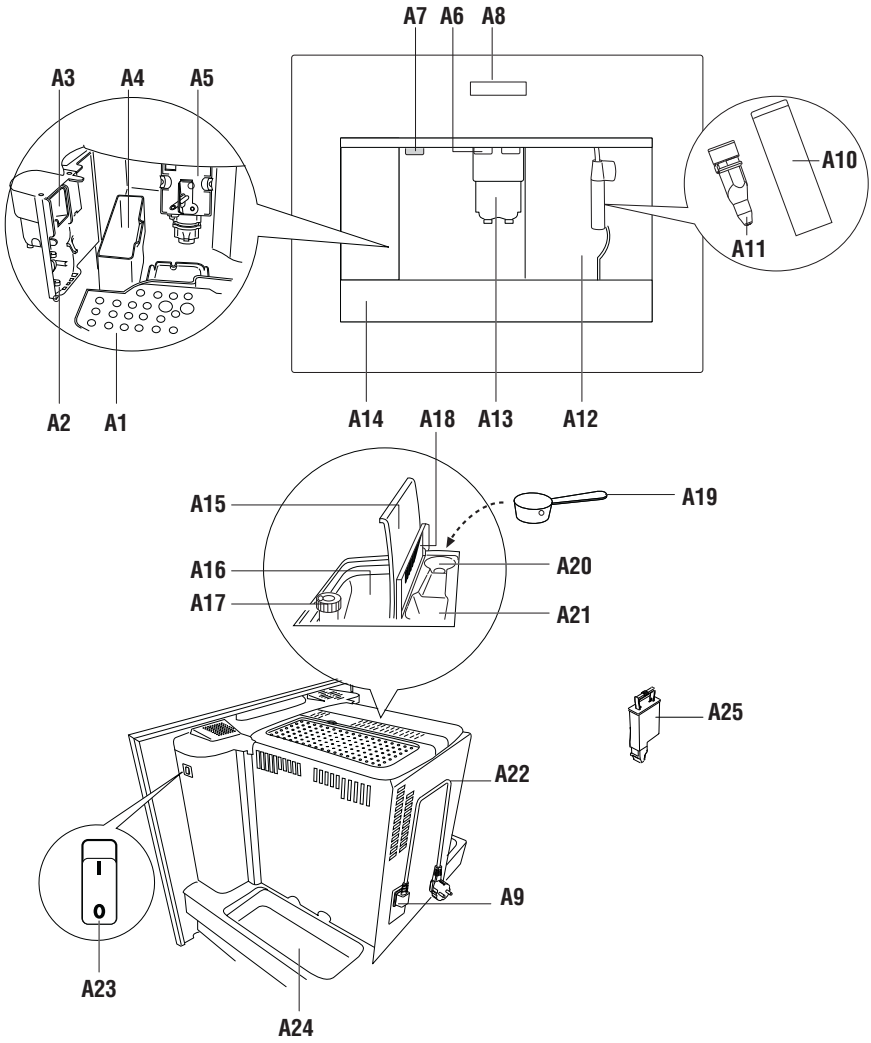

B

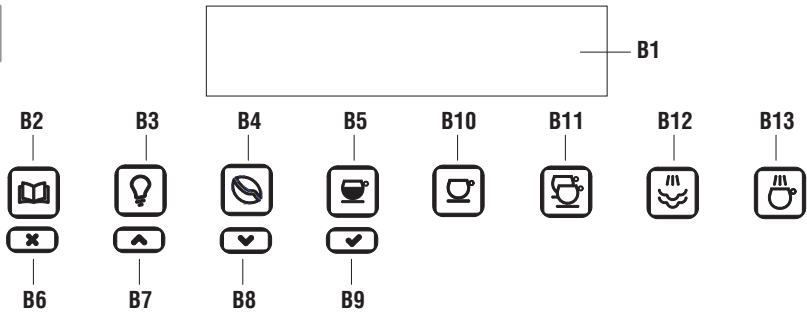

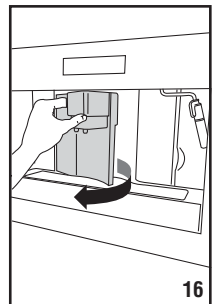
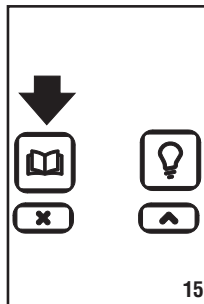
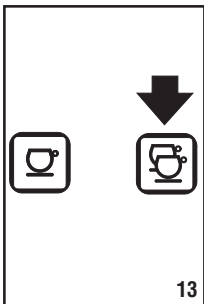
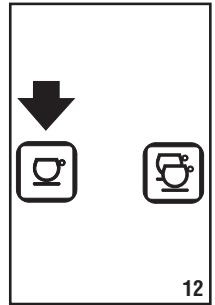
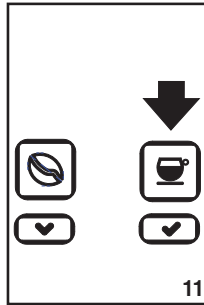
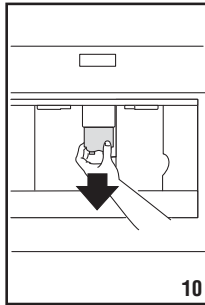
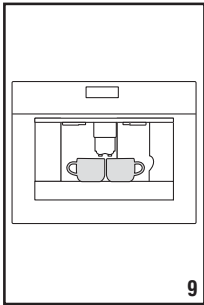
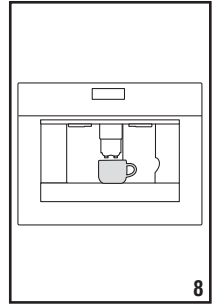
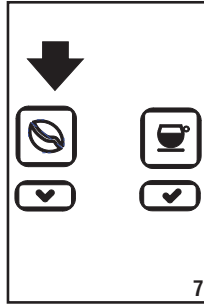
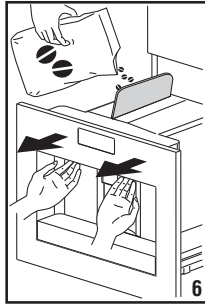
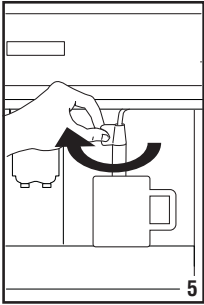
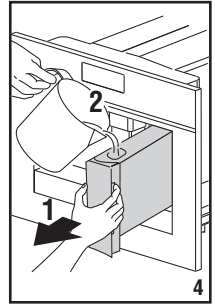
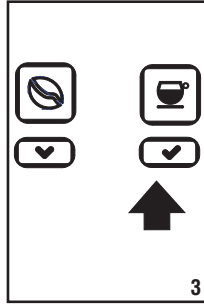
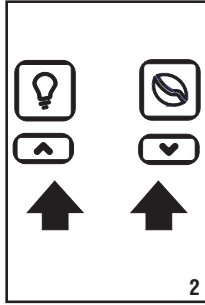
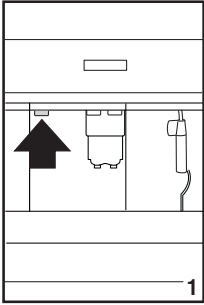

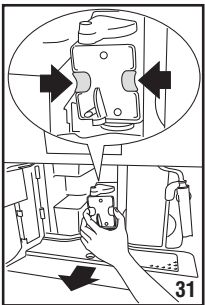
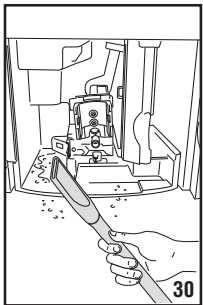
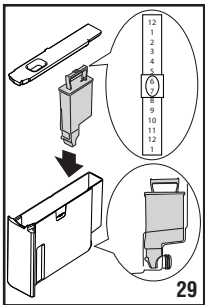
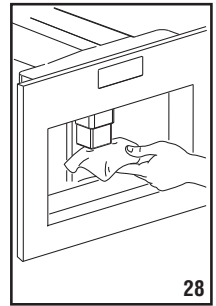
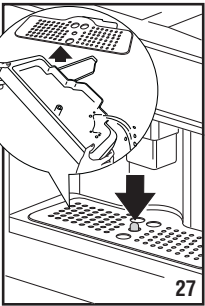
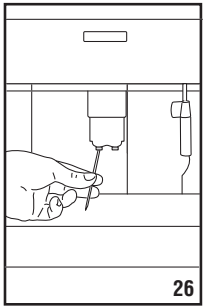
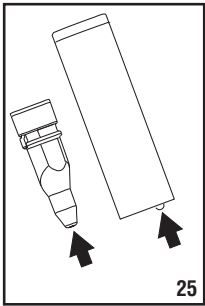
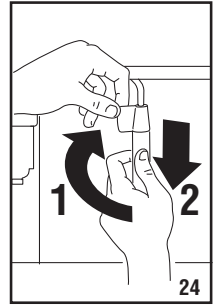
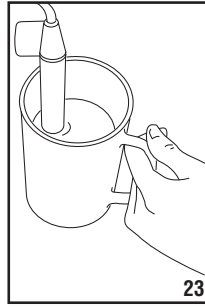
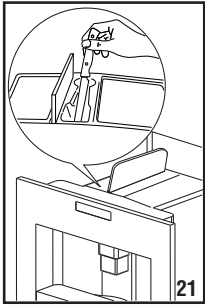
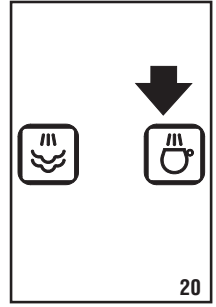
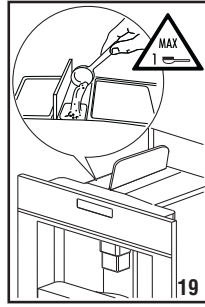
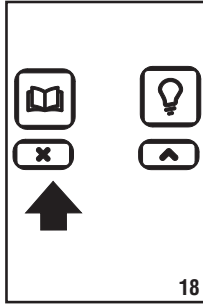
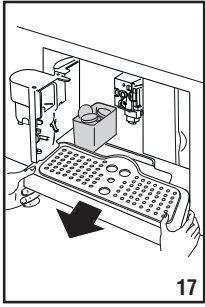

CONTENTS

INTRODUCTION	7
Symbols used in these instructions	7
Letters in brackets	7
Troubleshooting and repairs	7
SAFETY	7
Fundamental safety warnings	7
Designated use	8
Instructions	8
DESCRIPTION	8
Description of the appliance	8
Description of the control panel	8
PRELIMINARY CHECKS	9
Controls after transport	9
Installing the appliance	9
Connecting the appliance	9
DISPOSAL	9
BUILT-IN INSTALLATION	10
USING THE APPLIANCE FOR THE FIRST TIME	12
Installing the filter	12
Replacing the filter	13
Removing the filter	13
TURNING ON AND HEATING UP ...	13
MAKING COFFEE USING COFFEE BEANS	14
CHANGING THE QUANTITY OF COFFEE IN THE CUP	15
ADJUSTING THE COFFEE MILL	15
MAKING ESPRESSO COFFEE WITH PRE-GROUND COFFEE (INSTEAD OF BEANS)	15
DELIVERING HOT WATER	16
CHANGING THE QUANTITY OF HOT WATER	16
MAKING CAPPUCCINO (USING THE STEAM FUNCTION)	16
CLEANING	17
Cleaning the coffee maker	17
Cleaning the waste coffee container	17
Cleaning the drip tray	17
Cleaning the water tank	17
Cleaning the spouts	17
Cleaning the pre-ground coffee funnel	17
Cleaning the inside of the coffee maker	18
Cleaning the brewing unit	18
CHANGING AND SETTING MENU PARAMETERS	18
Setting the language	19
Rinsing	19
Changing the length of time the appliance remains on	19
Setting the clock	19
Setting auto-start time	19
Changing coffee temperature	20
Setting water hardness	20
Programming coffee	20
Programming water	20
Descaling	20
Resetting default values (reset)	21
Statistics	21
Buzzer	21
Adjusting contrast	21
Water filter	22
TURNING THE APPLIANCE OFF ...	22
TECHNICAL SPECIFICATION	22
DISPLAYED MESSAGES	23
TROUBLESHOOTING	25

INTRODUCTION

Symbols used in these instructions

Important warnings are identified by these symbols. Failure to observe the instructions could result in electric shock, serious injury, burns, fire or damage to the appliance.



Danger!

Failure to observe the warning could result in possibly life threatening injury from electric shock.



Important!

Failure to observe the warning could result in injury or damage to the appliance.



Danger of burns!

Failure to observe the warning could result in scalds or burns.



N.B.!

Important information for the user

Letters in brackets

The letters in brackets refer to the legend in the Description of the Appliance on page 3.

Troubleshooting and repairs

In the event of problems, follow the information given in the sections "Displayed messages" and "Troubleshooting".

If this does not resolve the problem, you should consult Customer Services.

For repairs, contact Customer Services only.

SAFETY

Fundamental safety warnings



Important! This is an household appliance only.

It is not intended to be used in:

- staff kitchen areas in shops, offices and other working environments;

- farm houses;
- by clients in hotels, motels and other residential type environments;
- bed and breakfast type environments.



Danger! This is an electrical appliance, it is therefore important to respect the following safety warnings:

- Never touch the appliance with damp hands.
- Never touch the plug with damp hands.
- Make sure the socket used is freely accessible at all times, enabling the appliance to be unplugged when necessary.
- **Unplug directly from the plug only. Never pull the power cable as you could damage it.**
- **To disconnect the appliance completely, place the main switch (A23) on the side of the appliance in the 0 position.**
- If the appliance is faulty, do not attempt to repair.
Turn it off using the main switch (A23), unplug from the mains socket and contact Customer Services.



Important! Keep all packaging (plastic bags, polystyrene foam) away from children.



Important! The appliance is not intended for use by persons (including children) with reduced physical, sensory or mental capabilities, or lack of experience and knowledge, unless they have been given supervision or instruction concerning use of the appliance by a person responsible for their safety.

Children must be supervised to ensure they do not play with the appliance.



Danger of burns! This appliance produces hot water and steam may form while it is in operation.

Avoid contact with splashes of water or hot steam. Use knobs and handles.



Important! Do not grasp the coffee maker when it is out of the cabinet. Do not rest recipients containing liquids or inflammable or corrosive materials on top of the appliance. Place the

accessories required to make the coffee (the measure for example) in the special holder. Do not rest large objects which could obstruct movement or unstable objects on the appliance.



Important! Do not use the appliance when extracted. Make sure the appliance is inactive before extracting it. The only exception is adjusting the coffee mill which must be done with the machine out (see the section "Adjusting the coffee mill").



N.B.! Use original or manufacturer recommended accessories and spare parts only.

Designated use

This appliance is designed and made to prepare coffee and heat drinks.

All other use is considered improper.

This appliance is not suitable for commercial use. The manufacturer is not liable for damage deriving from improper use of the appliance.

This appliance can be installed over a built-in oven if the latter is fitted with a cooling fan at the rear (maximum microwave power: 3 kW).

Instructions

Read these instructions carefully before using the appliance.

- Keep these instructions
- Failure to respect these instructions may result in burns or damage to the appliance.

The manufacturer is not liable for damage deriving from failure to respect these instructions.



N.B.! The appliance has a cooling fan. This comes on whenever coffee, steam or hot water is delivered. After several minutes, the fan goes off automatically.

DESCRIPTION

Description of the appliance

(page 3 - A)

A1. Cup tray

- A2. Service door
- A3. Coffee guide
- A4. Waste coffee container
- A5. Brewing unit
- A6. Cup tray lights
- A7. On/OFF/stand-by button
- A8. Control panel
- A9. IEC connector
- A10. Cappuccino maker (removable)
- A11. Cappuccino maker nozzle
- A12. Water tank
- A13. Coffee spout (adjustable height)
- A14. Drip tray
- A15. Bean container lid
- A16. Bean container
- A17. Grinding adjustment knob
- A18. Pre-ground coffee funnel door
- A19. Measure
- A20. Compartment for measure
- A21. Pre-ground coffee funnel
- A22. Power cable
- A23. Main switch
- A24. Tray
- A25. Water softener filter (optional)

Description of the control panel





(page 3 - B)











N.B.! Only the icons relating to the controls enabled for the particular function currently being used will be lit on the touch screen.



N.B.! A light touch is enough to activate the icon.

- B1. Display: guides the user in using the appliance.
- B2.  icon to activate or deactivate menu parameter setting mode
- B3.  icon to turn light A6 on and off
- B4.  icon to select the coffee taste
- B5.  icon to select the type of coffee (espresso, small cup, medium cup, large cup, mug)

- B6.  icon to exit the selected mode
- B7-B8.   icons to scroll forwards or backwards through the menu and display the various modes
- B9.  icon to confirm the selected function
- B10.  icon to deliver a cup of coffee
- B11.  icon to deliver two cups of coffee
- B12.  icon to deliver steam
- B13.  icon to deliver hot water

PRELIMINARY CHECKS

Controls after transport

After removing the packaging, make sure the product is complete and undamaged and that all accessories are present.

Do not use the appliance if it is visibly damaged. Contact Customer Services.

Installing the appliance



Important!

- The packing elements (plastic bags, polystyrene foam, etc.) should be kept out of reach of children.
- Do not install the appliance in rooms where the temperature may drop to 0°C or lower.
- Customise the water hardness as soon as possible following the instructions in the "Setting water hardness" section.

Connecting the appliance



Danger!

Check that the mains power supply voltage corresponds to the value indicated on the rating plate on the bottom of the appliance. Connect the appliance to an efficiently earthed and correctly installed socket with a minimum current rating of 10A only. If the power socket does not match the plug on the appliance, have the socket replaced with a suitable type by a qualified professional. To comply with safety di-

rectives, an omnipolar switch with a minimum contact distance of 3 mm must be installed. Do not use multiple sockets or extensions.



Important! Safety cutout devices must be included in the mains power supply in compliance with the installation regulations in the country concerned.



Important! Once the appliance is installed, the electrical cable, plug and power socket must be accessible.



Danger! If the supply cord is damaged, it must be replaced by the manufacturer or its service agent or a similarly qualified person in order to avoid a hazard.

DISPOSAL



Electrical appliances must not be disposed of as household waste. Appliances with this symbol are covered by European Directive 2002/96/EC. All unused electric and electronic appliances must be disposed of separately from household waste by taking them to state authorised special centres. Disposing of the unused appliance correctly avoids damage to the environment and a risk to health. For more information on disposing of the unused appliance, contact the local administration, the waste disposal department or the shop where the appliance was bought. **By ensuring this product is disposed of correctly, you will help prevent potential negative consequences for the environment and human health, which could otherwise be caused by inappropriate waste handling of this product. The symbol on the product indicates that this product may not be treated as household waste. Instead it shall be handed over to the applicable collection point for the recycling of electrical and electronic equipment. Disposal must be carried out in accordance with local environmental regulations for waste disposal. For more detailed information about treatment, recovery and recycling of this product, please contact your local city council office.**

BUILT-IN INSTALLATION

Verify the minimum measurements required for correct installation of the appliance.

The coffee maker must be installed in a column and the column must be firmly fixed to the wall with commercially available brackets.

Important:

- Important: all installation or maintenance operations must be performed with the appliance disconnected from the mains electricity supply.
- Kitchen furniture in direct contact with the appliance must be heat resistant (65°C min).
- To guarantee correct ventilation, leave a gap at the bottom of the cabinet (see measurements in figure).

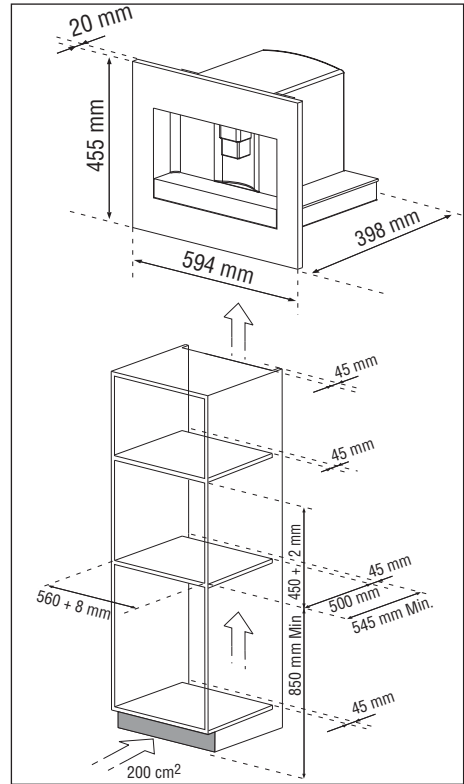
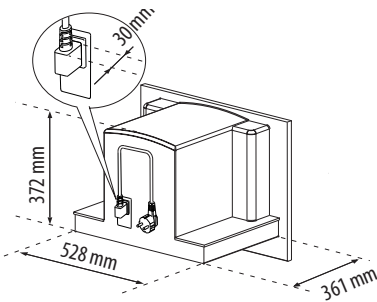

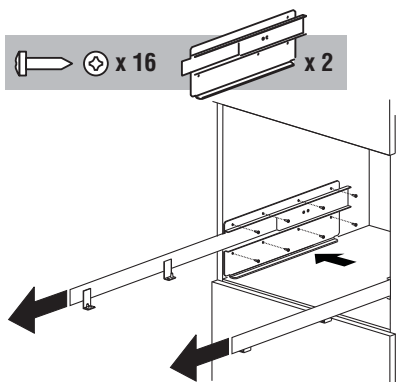

Position the rails on the sides of the cabinet as shown in the figure. Fix with the screws, then extract them completely. If the coffee maker is installed over a warmer drawer, use the top surface of this as a reference to position the rails. In this case, there will be no surface to rest the rails on.

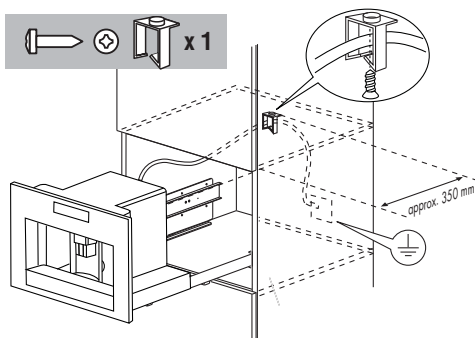

Fix the power cable with the clip. The power cable must be long enough to allow the appliance to be extracted from the cabinet to fill the coffee bean container.

The appliance must be earthed in compliance with legislation.

Electrical connections must be performed by a qualified electrician following the instructions.

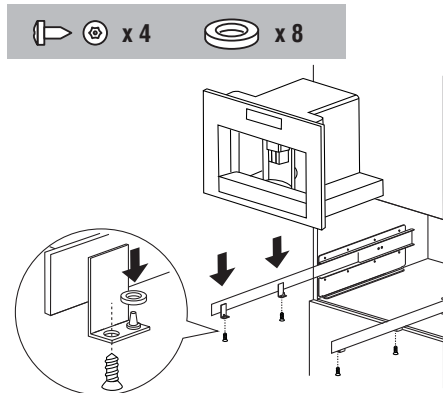



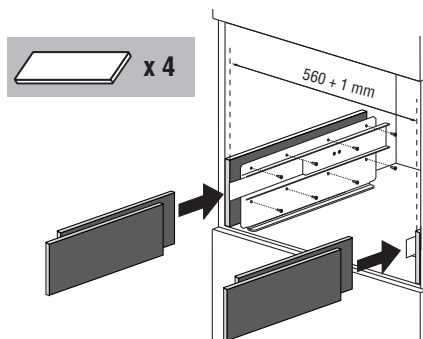

Position the appliance on the rails, making sure the pins are correctly inserted in the housings, then fix it with the screws supplied. If the height of the appliance requires adjusting, use the spacer disks provided.





If necessary, correct alignment of the appliance by positioning the spacers supplied under or at the sides of the support.

USING THE APPLIANCE FOR THE FIRST TIME

- Coffee has been used to factory test the appliance and it is therefore completely normal for there to be traces of coffee in the mill.
 - Customise water hardness as soon as possible following the instructions in the "Setting water hardness" section.
1. Connect the appliance to the mains supply. Set the required language.
 2. To set the language, use the   icons (B7 and B8) to choose the required language (fig. 2). When the message "PRESS OK TO CHOOSE ENGLISH" is displayed, press the  icon (B9) (fig. 3) for 3 seconds until "ENGLISH INSTALLED" is displayed. If you set the wrong language, follow the instructions in the "Setting the language" section. If your language is not available, select one from those displayed. The instructions refer to the English version. Then follow the instructions displayed:
 3. After 5 seconds, the appliance displays "FILL TANK". Extract the water tank (fig. 4), rinse and fill with fresh water without exceeding the MAX line. Replace and push as far as it will go. A water softener filter can be installed in the tank (fig. 29).
 4. Place a cup under the cappuccino maker (fig. 5). The appliance displays: "HOT WATER PRESS OK". Press the  icon (B9) (fig. 3) and after a few seconds a little water comes out of the cappuccino maker.
 5. The machine now displays "TURNING OFF... PLEASE WAIT" and goes off.
 6. Extract the appliance by pulling it out using the handles (fig. 6). Open the lid and fill the container with coffee beans, then close the lid and push the appliance in.

The coffee maker is now ready for normal use.

 **Important!** Never introduce pre-ground coffee, freeze dried coffee, caramelised beans or anything else which could damage the appliance.

 **N.B.!** When using the appliance for the

first time, you need to make 4-5 cups of coffee and 4-5 cappuccinos before the appliance gives satisfactory results.

 **N.B.!** Each time you turn the coffee maker on by the ON/OFF switch (A23), it performs a SELF-DIAGNOSIS cycle and then goes off. To turn it on again, press the ON/OFF button (A7) (fig. 1)

Installing the filter

Some models are fitted with a water softener filter to improve the quality of the water used and extend the working life of the appliance.







To install, proceed as follows:

1. Remove the filter from the packaging;
2. Slide the date indicator pointer (see fig. 29) until the months of use are displayed.

 **N.B.!** The filter lasts about two months if the appliance is used normally. If the coffee maker is left unused with the filter installed, it will last a maximum of three weeks.

3. Fill the tank with a little water up to the level shown in the figure:



4. Insert the filter in the water tank and press it until it touches the bottom of the tank (see fig. 29);
5. Fill the water tank and insert in the coffee maker;
6. Place a container underneath the cappuccino maker (min. capacity: 100 ml).
7. Press the  icon (B2) to enter the menu;
8. Press the   icons (B7) and (B8) until "INSTALL FILTER" is displayed;
9. Press the  icon (B9);
10. The message "INSTALL FILTER PLEASE CONFIRM" is displayed.
11. Press the  icon (B9) to confirm the selection (or  (B6) to cancel). "HOT WATER PRESS OK" is displayed.
12. Press the  icon (B9) again. The ap-







pliance begins delivering hot water and the message "PLEASE WAIT..." is displayed.

When delivery stops, the appliance automatically displays the basic modes set again.

 **N.B.!** The appliance may request the operation to be repeated a number of times until the air is completely eliminated from the hydraulic circuit.

Replacing the filter ("FILTER RESET")







When "REPLACE FILTER" is displayed or after 2 months of use (see date indicator), the filter must be replaced:

1. Remove the exhausted filter;
2. Remove the new filter from the packaging.
3. Slide the pointer of the date indicator (see fig. 29) until the months of use are displayed (the filter lasts about 2 months);
4. Insert the filter in the water tank and press it until it touches the bottom of the tank (see fig. 29);
5. Fill the water tank and insert in the coffee maker;
6. Turn the cappuccino maker outwards and place a container underneath (min. capacity 100 ml).
7. Press the  icon (B2) to enter the menu;
8. Press the   icons (B7) and (B8) until "FILTER RESET" is displayed;
9. Press the  icon (B9);
10. The message "FILTER RESET CONFIRM" is displayed.
11. Press the  icon (B9) to confirm the selection (or  (B6) to cancel). "HOT WATER PRESS OK" is displayed.
12. Press the  icon (B9) again. The appliance begins delivering hot water and the message "PLEASE WAIT..." is displayed. When delivery stops, the appliance automatically displays the basic modes set again.

Removing the filter

To use the appliance without a filter, you must remove it and notify the appliance of its removal as

follows:

1. Press the  icon (B2) to enter the menu;
2. Press the   icons (B7) and (B8) until "INSTALL FILTER" is displayed;
3. Press the  icon (B9);
4. The message "INSTALL FILTER* CONFIRM" is displayed.
5. Press the  icon (B6).
6. When the asterisk has disappeared from the top right of the display, press  (B6) to exit the menu.

 **N.B.!** Use the filters recommended by the manufacturer only. Use of unsuitable filters could damage the appliance.

TURNING ON AND HEATING UP

Each time the appliance is turned on, it performs an automatic preheat and rinse cycle which cannot be interrupted. The appliance is ready for use only after completion of this cycle.



 **Danger of burns!** During rinsing, a little hot water flows from the coffee spouts.

To turn the appliance on, press the ON/OFF/stand-by button (A7) (fig. 1). The message "HEATING UP... PLEASE WAIT" is displayed. When heating is complete, the message changes to "RINSING"; The appliance is at temperature when the message "MEDIUM CUP NORMAL TASTE" is displayed. If no icon is pressed within about 2 minutes, the time (if set, see the "Setting the clock" section) is displayed. If the time has not been set, the appliance displays the last functions set. When any icon is pressed, "MEDIUM CUP NORMAL TASTE" is displayed again. The appliance is ready to make coffee again.

MAKING COFFEE USING COFFEE BEANS

1. The appliance is preset to make coffee with a

normal taste. You can also choose coffee with an extra-mild, mild, strong or extra-strong taste. There is also a pre-ground coffee option. To choose the required taste, press the  icon (B4) (fig. 7). The required coffee taste is displayed.

- Place 1 cup under the spouts to make 1 coffee (fig. 8) or 2 cups for 2 coffees (fig. 9). Lower the spouts as near as possible to the cup for a creamier coffee (fig. 10).
- Press the  icon (B5) (fig. 11) to select the type of coffee: espresso, small cup, medium cup, large cup, mug. Now press the  icon (B10) (fig. 12) if you want to make a coffee and the  icon (B11) (fig. 13) if you want to make 2 coffees. The appliance now grinds the beans and starts delivering the coffee into the cup. Once the set amount of coffee has been delivered, the machine stops delivery automatically and expels the exhausted waste coffee into the waste coffee container.
- After a few seconds, the appliance is ready for use again.
- To turn the appliance off, press the ON/OFF/stand-by button (A7) (fig. 1). (Before going off, the appliance performs an automatic rinse cycle. Take care to avoid scalds).

NOTE 1: If the coffee is delivered a drop at a time or not at all, see the "Adjusting the coffee mill" section.

NOTE 2: If the coffee is delivered too fast and the cream is not satisfactory, see the "Adjusting the coffee mill" section.

NOTE 3: Tips for a hotter coffee:

- Proceed as described in the section "Changing and setting menu parameters", "Rinse" function.
- Unless preheated, do not use excessively thick cups as they will absorb too much heat.
- Preheat the cups by rinsing them with hot water.

NOTE 4: Coffee delivery can be interrupted at any moment by re-pressing the previously selected icon which remains lit during the operation.

NOTE 5: As soon as delivery is finished, to increase the quantity of coffee in the cup, just keep

pressing the previously selected icon within 3 seconds after delivery has finished.

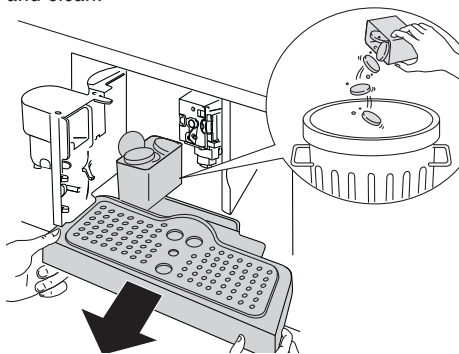

NOTE 6: When the appliance displays "FILL TANK", fill the tank with water or the appliance will not deliver coffee. (It is normal for there to be a little water left in the tank).

NOTE 7: After about 14 single (or 7 double) coffees, the appliance displays "EMPTY WASTE COFFEE CONTAINER". **Even if not full, the empty waste coffee container message is displayed 72 hours after the first coffee has been delivered. For the 72 hours to be calculated correctly, the machine must never be turned off with the main switch in the 0 position.** To clean, open the service door on the front of the appliance by pulling the spout (fig. 16), extract the drip tray (fig. 17) and clean.



When cleaning, **always extract the drip tray completely.**

 **Important!** When extracting the drip tray, the waste coffee container **MUST** always be emptied. If this is not done, the machine may be clogged.

NOTE 8: Never extract the water tank while the machine is delivering coffee. If it is removed, it will not be possible to make the coffee and the appliance will display "GROUND TOO FINE ADJUST MILL AND PRESS OK" and then "FILL TANK". Check the level of water in the tank and replace in the appliance. To turn the machine on again, press the  icon (B9). "HOT WATER PRESS OK" is displayed. Press the  icon (B9) within a few seconds and deliver water from

the cappuccino maker for about 30 seconds. When delivery stops, the basic modes are displayed again.

i N.B.: The coffee maker may request the operation to be repeated a number of times until the air is completely eliminated from the hydraulic circuit.













i N.B.: if this operation is not performed correctly or if the machine is turned off, the basic modes may be displayed, although the problem is in fact still present.

CHANGING THE QUANTITY OF COFFEE IN THE CUP

The appliance is set by default to automatically make the following types of coffee:

- espresso
- small cup
- medium cup
- large cup
- mug

To change the quantity, proceed as follows:

- Press the  icon (B2) to enter the menu (fig. 15). Press the   icons (B7) and (B8) (fig. 2) until "PROGRAM COFFEE" is displayed.
- Press the  icon (B9).
- Select the type of coffee you want to change by pressing the   icons (B7) and (B8).
- Press the  icon (B9) to confirm the type of coffee you want to make.
- Use the   icons (B7) and (B8) to change the quantity of coffee. The progress bar shows the quantity of coffee selected.
- Press the  icon (B9) again to confirm (or the  icon (B6) to cancel the operation).
- Press the  icon (B6) (fig. 18) twice to exit the menu.

The appliance is now reprogrammed with the new settings and is ready.

ADJUSTING THE COFFEE MILL

The coffee mill is preset in the factory and should not require adjusting. However, if after making the first few coffees you find that delivery is either too fast or too slow (a drop at a time), this can be corrected by adjusting the grinding adjustment knob (fig. 14).

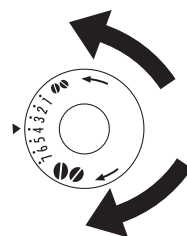

! Important! The grinding adjustment knob must only be turned when the coffee mill is in operation.



For slower delivery and creamier coffee, turn one click anticlockwise (finer pre-ground coffee).

For faster delivery (not a drop at a time), turn one click clockwise (coarser pre-ground coffee).

MAKING COFFEE USING PRE-GROUND COFFEE

- Press the  icon (B4) (fig. 7) and select the pre-ground coffee function.
- Extract the machine by pulling it outwards using the handles.
- Lift the central lid, place one measure of pre-ground coffee in the funnel (fig. 19), push the appliance in then proceed as described in the section "Making coffee using coffee beans".
N.B.: You can make just one coffee at a time by pressing the  icon (B10) (fig. 12).
- After using the machine with pre-ground coffee, to go back to making coffee using beans, deactivate the pre-ground coffee function by pressing the  icon (B4) (fig. 7).

NOTE 1: Never introduce pre-ground coffee when the machine is off or it could spread through the inside of the appliance.

NOTE 2: Never add more than 1 measure, otherwise the appliance will not make the coffee.





NOTE 3: Use the measure provided only.

NOTE 4: Introduce only pre-ground coffee for

espresso coffee machines into the funnel.

NOTE 5: If more than one measure of pre-ground coffee is used and the funnel clogs, push the coffee down with a knife (fig. 21) then remove and clean the brewing unit and machine as described in the "Cleaning the brewing unit" section.









DELIVERING HOT WATER

- Always make sure the appliance is ready.
- Turn the cappuccino maker outwards and place a container underneath (fig. 5).
- Press the  icon (B13) (fig. 20). The appliance displays: "HOT WATER PRESS OK". Press the  icon (B9) again and hot water is delivered from the cappuccino maker into the container underneath. You should not deliver hot water for more than 2 minutes at a time. To interrupt, press the  icon (B13) or the  icon (B6). The appliance stops delivery once the set quantity is reached.











CHANGING THE QUANTITY OF HOT WATER

The machine is set by default to automatically deliver 200 ml of hot water.

To change these quantities, proceed as follows:

- Place a container underneath the cappuccino maker (fig. 5).
- Press the  icon (B2) to enter the menu (fig. 15) or press the   icons (B7) and (B8) (fig. 2) until "PROGRAM HOT WATER" is displayed.
- Press the  icon (B9) to confirm.
- Select the required quantity of water by pressing the   icons (B7) and (B8). The progress bar shows the quantity of water selected.
- Press the  icon (B9) to confirm (or the  icon (B6) to cancel the operation.
- Press the  icon (B6) (fig. 18) twice to exit the menu.
- The appliance is now reprogrammed with the new settings and is ready.

MAKING CAPPUCCINO (USING THE STEAM FUNCTION)

- Turn the cappuccino maker towards the centre (fig. 5).
- Take a container, fill it with about 100 g of milk for each cappuccino to be made and place it under the cappuccino maker. In choosing the size of the recipient, bear in mind that the milk doubles or triples in volume. You are recommended to use partially skimmed milk at refrigerator temperature.
- Press the  icon (B12) (fig. 22). "STEAM PRESS OK" is displayed.
- Press the  icon (B9).
- To interrupt steam delivery, press the  icon (B12) again or the  icon (B6).
- Immerse the cappuccino maker in the milk container (fig. 23), taking care not to immerse it for more than half its length. Press the  icon (B12) (take care to avoid scalds) and press the  icon (B9). Steam comes out of the cappuccino maker. For a creamier froth, immerse the cappuccino maker in the milk and move the container with slow upward movements. You should not deliver steam for more than 2 minutes at a time.
- When the required temperature is reached, interrupt steam delivery by pressing the  icon (B12) again or the  icon (B6).
- Make the coffee as described above using sufficiently large cups, then fill them with the frothed milk prepared previously. **IMPORTANT:** always clean the cappuccino system immediately after use. Proceed as follows:
 - Press the  icon (B12) and then press the  button (B9) to discharge a small amount of steam for a few seconds. This empties the steam spout of all traces of milk. **IMPORTANT:** to ensure the hygiene of the appliance, you are recommended to carry out this procedure each time you make cappuccino to avoid stale milk remaining in the circuit.
- Wait for the cappuccino maker to cool down,

then holding the cappuccino maker lever firmly in one hand, unscrew the cappuccino maker itself with the other, turning it anticlockwise and removing it downwards (fig. 24).

- Remove the cappuccino maker nozzle by pulling it downwards.
- Wash the cappuccino maker and nozzle thoroughly in hot water.
- Make sure the two holes shown in figure 25 are not blocked. If necessary, clean with a pin.
- Replace the nozzle by inserting it upwards into the cappuccino maker.
- Replace the cappuccino maker by pushing it upwards and rotating it clockwise.

CLEANING

Cleaning the coffee maker

Do not use solvents or abrasive detergents to clean the coffee maker. A soft damp cloth will suffice. Never wash any of the components of the coffee maker in the dishwasher.

The following parts of the machine must be cleaned regularly:

- Waste coffee container (A4).
- Drip tray (A14).
- Water tank (A12).
- Coffee (A13), hot water (A11) and cappuccino maker spouts (A10).
- Pre-ground coffee funnel (A21).
- Inside of the machine, accessible after opening the service door (A2).
- Brewing unit (A5).
- Coffee jug.

Cleaning the waste coffee container

When "EMPTY WASTE COFFEE CONTAINER" is displayed, the waste coffee container must be emptied and cleaned. To clean:

- open the service door on the front of the appliance (fig. 16), extract the drip tray (fig. 17) and clean.
- Clean the waste coffee container thoroughly.



Important! When extracting the drip tray,

the waste coffee container must always be emptied.

Cleaning the drip tray



Important! If the drip tray is not emptied the water might overflow. This could damage the machine. The drip tray is fitted with a level indicator (red) showing the level of water it contains (fig. 27). Before the indicator protrudes from the cup tray, the drip tray must be emptied and cleaned. To remove the tray:

1. Open the service door (fig. 16).
2. Remove the drip tray and the waste coffee container (fig. 17).
3. Clean the drip tray and waste coffee container (A4).
4. Replace the drip tray and waste coffee container (A4).
5. Close the service door.

Cleaning the water tank

1. Clean the water tank (A12) regularly (about once a month) with a damp cloth and a little mild washing up liquid.
2. Remove all traces of washing up liquid.

Cleaning the spouts

1. Clean the nozzles periodically using a sponge (fig. 28).
2. Check regularly that the holes in the coffee spout are not blocked. If necessary, remove coffee deposits with a toothpick (fig. 26).

Cleaning the pre-ground coffee funnel

- Check regularly (about once a month) that the pre-ground coffee funnel is not blocked (fig. 21).



Danger! Before performing any cleaning operations, the machine must be turned off by pressing the main switch (A23) and unplugged from the mains power supply. Never immerse the coffee maker in water.

Cleaning the inside of the coffee maker

1. Check regularly (about once a week) that the inside of the appliance is not dirty. If necessary, remove coffee deposits with a sponge.
2. Remove the residues with a vacuum cleaner (fig. 30).

Cleaning the brewing unit

The brewing unit must be cleaned at least once a month.

! **Important!** The brewing unit (A5) must not be removed when the appliance is on. Do not use force to remove the brewing unit.

1. Make sure the machine is correctly turned off (see "Turning the appliance off").
2. Open the service door (fig. 16).
3. Remove the drip tray and waste coffee container (fig. 17);
4. Press the two red release buttons inwards and at the same time pull the brewing unit outwards (fig. 31).

! **Important!** Do not use washing up liquid to clean the brewing unit. It would remove the lubricant applied to the inside of the piston.

5. Soak the brewing unit in water for about 5 minutes, then rinse.
6. After cleaning, replace the brewing unit (A5) by sliding it onto the internal support and pin at the bottom, then push the PUSH symbol fully in until it clicks into place.

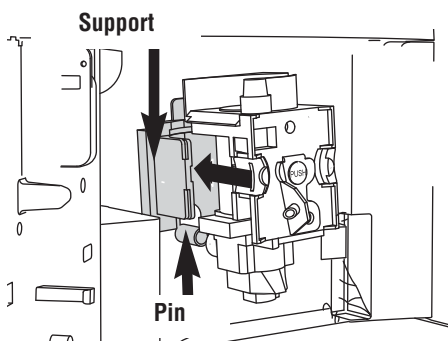

i **N.B.!** If the brewing unit is difficult to insert, you must first adapt it to the right dimensions by pressing it forcefully from the bottom and top as shown in the figure.

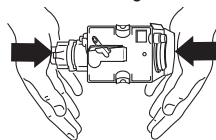

7. Once inserted, make sure the two red buttons have snapped out.

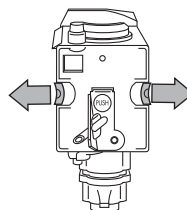

8. Replace the drip tray and waste coffee container.
9. Close the service door.

CHANGING AND SETTING MENU PARAMETERS







When the appliance is ready, you can use the internal menu to modify the following parameters and functions:

- Choose language
- Rinsing
- Shut-off time
- Set clock
- Start time
- Auto-start
- Temperature
- Water hardness
- Program coffee
- Program jug
- Program water
- Descale
- Reset to default
- Statistics
- Install filter
- Reset filter

- Buzzer
- Contrast

Setting the language

To change the language on the display, proceed as follows:





- Press the  icon (B2) to enter the menu. "CHOOSE LANGUAGE" is displayed.
- Press the  icon (B9).
- Press the   icons (B7) and (B8) until the required language is displayed.
- Press the  icon (B9) to confirm.
- Press the  icon (B6) to exit the menu.

 **N.B.!** If you choose the wrong language, you can access the menu directly to modify the parameter.

- Press the  icon button (B2) for at least 7 seconds until the appliance displays the various languages.
- Choose the required language as described in the section "Using the appliance for the first time".

Rinsing









This function enables you to obtain hotter coffee. Proceed as follows:

- When you turn the appliance on, if you want to make a small cup of coffee (less than 60 cc), preheat the cup by rinsing it with hot water.
- If on the other hand more than 2/3 minutes have passed since the last coffee was made, before requesting another coffee, you must preheat the brewing unit by first pressing the  icon (B2) to enter the menu then the   icons (B7) and (B8) to select the "RINSING" function.
Press the  icon (B9). "RINSING... PLEASE CONFIRM" is displayed.
Press the  icon (B9) again.
Deliver the water into the underlying drip tray or alternatively use this water to fill (and then empty) the cup to be used for the coffee to preheat it.











Changing the length of time the appliance remains on

The appliance is set by default to go off automatically 30 minutes after the last coffee has been made.

To change this interval (max. 120 min), proceed as follows:













- Press the  icon (B2) to enter the menu and then the   icons (B7) and (B8) until "SHUT-OFF TIME" is displayed.
- Press the  icon (B9) to confirm.
- Press the   icons (B7) and (B8) to set the time after which the appliance will go off (after 1/2 hour, 1 hour, 2 hours).
- Press the  icon (B9) to confirm.
- Press the  icon (B6) to exit.

Setting the clock









- Press the  icon (B2) to enter the menu and then the   icons (B7) and (B8) until "SET CLOCK" is displayed.
- Press the  icon (B9).
- Use the   icons (B7) and (B8) to set the hour, then press the  icon (B9) to confirm.
- Use the   icons (B7) and (B8) to set the minutes, then press the  icon (B9) to confirm.
- Press the  icon (B6) to exit the menu.

Setting auto-start time

This function programmes the time the machine will come on automatically.









- Make sure the clock on the appliance has been set.
- Press the  icon (B2) to enter the menu and then the   icons (B7) and (B8) until "START TIME" is displayed.
- Press the  icon (B9).
- Use the   icons (B7) and (B8) to set the auto-start time, then press the  icon (B9) to confirm.
- Use the   icons (B7) and (B8) to set the minutes, then press the  icon (B9) to confirm.
- Press the   icons (B7) and (B8) to

activate the auto-start function until "AUTO START" is displayed.

- Press the  icon (B9) to confirm. The  symbol appears on the display.
- Press the  icon (B6) to exit the menu.
- To deactivate the automatic start-up function, press the  (B2) icon, then press the   (B7) and (B8) icons until the appliance displays the message "AUTO ACCENSIONE" (AUTO START-UP). Press the  (B9) icon. "CONFERMARE" (CONFIRM) will appear on the display. Press  to deactivate and the  symbol will disappear.

Changing coffee temperature







To change coffee temperature, proceed as follows:

- Press the  icon (B2) to enter the menu and then the   icons (B7) and (B8) until "TEMPERATURE" is displayed.
- Press the  icon (B9).
- Press the   icons (B7) and (B8) to select the required coffee temperature from low, medium and high.
- Press the  button (B9) to confirm the temperature selected.
- Press the  icon (B6) to exit the menu.

Setting water hardness

The operating period can be extended if required, making descaling less frequent by programming the machine on the basis of the real lime content in the water used.

Proceed as follows:

- remove the "Total Hardness Test" strip (attached to page 2) from its packaging then dip it fully in the water for a few seconds, then remove and wait about 30 seconds (until it changes colour and forms red squares).
- turn the appliance on by pressing the ON/OFF/stand-by button (A7).
- Press the  icon (B2) to enter the menu and then the   icons (B7) and (B8) until "WATER HARDNESS" is displayed.
- Press the  icon (B9).
- Press the   icons (B7) and (B8) until the number coincides with the number

of red squares on the test strip (for example, if there are 3 red squares on the test strip, select the message "WATER HARDNESS 3" .

- Press the  icon (B9) to confirm. The coffee maker is now programmed to provide the descale warning when actually necessary.

Programming coffee

For instructions on programming coffee, see the "CHANGING THE QUANTITY OF COFFEE IN THE CUP" section.

Programming water

For instructions, see the "CHANGING THE QUANTITY OF HOT WATER" section.

Descaling





 **Important!** Descaler contains acids. Respect the safety warnings provided by the manufacturer and given on the descaler pack.

 **N.B.!** Use the descaler recommended by the manufacturer only. Use of other descalers invalidates the guarantee. Failure to descale the appliance as described also invalidates the guarantee.





 **Important!** Before descaling, make sure the water softener filter has been removed.

When "PLEASE DESCALE !" is displayed, the machine requires descaling.

Proceed as follows:

- Make sure the machine is ready;
- Press the  icon (B2) to enter the menu and then the   icons (B7) and (B8) until "DESCALE" is displayed.
- Press the  icon (B9) and the appliance displays "DESCALE PLEASE CONFIRM".
- Press the  icon (B9). The message "ADD DESCALER PLEASE CONFIRM" is displayed.
- Empty the tank of water, pour the contents of the descaler bottle into the tank respecting the instructions given on the descaler pack,

then add water up to the MAX level marked on the water tank. Position a container with a capacity of about 2 litres under the hot water spout.

- Press the  icon (B9). Descaler flows out of the hot water spout into the container below. The appliance displays: "DESCALING".
- The descale programme automatically performs a series of deliveries and pauses.
- After about 30 minutes "DESCALE COMPLETE PLEASE CONFIRM" is displayed.
- Press the  icon (B9). "RINSING PLEASE CONFIRM" is displayed.
- Empty the water tank, rinse to eliminate descaler residues, then fill with clean water.
- Replace the tank full of clean water. "RINSING PLEASE CONFIRM" is displayed again.
- Press the  icon (B9) again. Hot water flows out of the spout into the container below and "RINSING" is displayed.
- Wait until "RINSING COMPLETE PLEASE CONFIRM" is displayed.
- Press the  icon (B9). "DESCALE COMPLETE" is displayed, then "FILL TANK". Fill the tank again with clean water.
- The descale programme is now terminated and the appliance is ready to make coffee again.





NOTE: If descaling is interrupted before completion, the process must be begun again from the beginning.



Important! FAILURE TO DESCALE THE APPLIANCE REGULARLY INVALIDATES THE GUARANTEE.

Resetting default values (reset)

E' possibile ritornare alle impostazioni originali della macchina (anche dopo che l'utente le ha modificate) procedendo nel seguente modo:







- Press the  icon (B2) to enter the menu and then the   icons (B7) and (B8) until "RESET TO DEFAULT" is displayed.
- Press the  icon (B9) and the appliance displays "RESET TO DEFAULT PLEASE CONFIRM".
- press the  button (B9) to reset the de-

fault values;

Statistics

This displays statistics relating to the machine.

To display, proceed as follows:







- Press the  icon (B2) to enter the menu and then the   icons (B7) and (B8) until "STATISTICS" is displayed.
- Press the  icon (B9).
- Press the   icons (B7) and (B8) to verify:
 - How many coffees have been made.
 - How many times the machine has been descaled.
 - The total number of litres of water delivered.
- Press the  icon (B6) once to exit the function or twice to exit the menu.

Buzzer

This activates or deactivates the buzzer emitted by the machine each time an icon is pressed or an accessory is inserted/removed.











N.B.! The buzzer is active by default.

- Press the  icon (B2) to enter the menu and then the   icons (B7) and (B8) until "BUZZER" is displayed.
- Press the  icon (B9). "BUZZER PLEASE CONFIRM" is displayed.
- Press the  icon (B6) to disable or the  icon (B9) to enable the buzzer.
- Press the  icon (B6) to exit the menu.

Adjusting contrast

To increase or reduce the contrast of the display, proceed as follows:

- Press the  icon (B2) to enter the menu and then the   icons (B7) and (B8) until "CONTRAST" is displayed.
- Press the  icon (B9).
- Press the   icons (B7) and (B8) until the required display contrast is reached. The progressive bar indicates the level of contrast selected.
- Press the  icon (B9) to confirm.

- Press the  icon (B6) once to exit the function or twice to exit the menu.

Water filter

For instructions on the water softener filter, see the section "INSTALLING THE FILTER".

TURNING THE APPLIANCE OFF

Each time the appliance is turned off, it performs an automatic rinse cycle which cannot be interrupted.

 **Danger of burns!** During rinsing, a little hot water flows from the coffee spouts. Avoid contact with splashes of water. To turn the appliance off, press the ON/OFF button (A7). The appliance performs the rinse cycle then goes off.

 **N.B.!** If the appliance is not used for an extended period, place the main switch on the back of the appliance in the 0 position (A23).

TECHNICAL SPECIFICATION

Voltage: 220-240 V~ 50/60 Hz max. 10A

Absorbed power: 1350 W

Pressure: 15 bars

Water tank capacity: 1.8 litres

Size LxHxD: 594 x 455 x 398 mm

Weight: 23/24 kg

 The appliance complies with the following EC directives:

- Low Voltage Directive 2006/95/EC and subsequent amendments;
- EMC Directive 2004/108/EC and subsequent amendments
- [EC Regulation 1275/2008 for standby](#)

Materials and accessories coming into contact with food conform to European regulation (EC) no. 1935/2004.

FOR ASUTRALIAN MARKET: PLUG COMPLYING LOCAL REQUIREMENTS INCLUDED IN THE PACKAGE.

ELECTRICAL CONNECTION (UK ONLY)

A) If your appliance comes fitted with a plug, it will incorporate a 13 Amp fuse. If it does not fit your socket, the plug should be cut off from the mains lead, and an appropriate plug fitted, as below.

WARNING: Very carefully dispose of the cut off plug after removing the fuse: do not insert in a 13 Amp socket elsewhere in the house as this could cause a shock hazard.

With alternative plugs not incorporating a fuse, the circuit must be protected by a 15 Amp fuse. If the plug is a moulded-on type, the fuse cover must be re-fitted when changing the fuse using a 13 Amp Asta approved fuse to BS 1362. In the event of losing the fuse cover, the plug must NOT be used until a replacement fuse cover can be obtained from your nearest electrical dealer. The colour of the correct replacement fuse cover is that as marked on the base of the plug.

B) If your appliance is not fitted with a plug, please follow the instructions provided below:

WARNING - THIS APPLIANCE MUST BE EARTHED

IMPORTANT

The wires in the mains lead are coloured in accordance with the following code:

Green and yellow: Earth

Blue: Neutral

Brown: Live





As the colours of the wires in the mains lead may not correspond with the coloured markings identifying the terminals in your plug, proceed as follows:

The green and yellow wire must be connected to the terminal in the plug marked with the letter E or the earth symbol  or coloured green or green and yellow.

The blue wire must be connected to the terminal marked with the letter N or coloured black.

The brown wire must be connected to the terminal marked with the letter L or coloured red.

DISPLAYED MESSAGES

DISPLAYED MESSAGE	POSSIBLE CAUSE	REMEDY
FILL TANK	<ul style="list-style-type: none"> The water tank is empty or positioned incorrectly. 	<ul style="list-style-type: none"> Fill the tank with water and/or insert it correctly, pushing it as far as it will go.
GROUND TOO FINE ADJUST MILL AND <i>(alternating with)</i> PRESS OK	<ul style="list-style-type: none"> The grinding is too fine and the coffee is delivered too slowly. The machine cannot make coffee as there is air in the hydraulic circuit Possible cause: the filter has not been installed correctly. 	<ul style="list-style-type: none"> Turn the grinding adjustment knob one click clockwise towards "7". Make sure the filter (A25) is properly installed and that the installation has been carried out correctly.
GROUND TOO FINE ADJUST MILL AND <i>(alternating with)</i> PRESS OK <i>(then)</i> FILL TANK	<ul style="list-style-type: none"> The tank has been removed during delivery. 	<ul style="list-style-type: none"> Insert the tank and press the  icon (B9). "HOT WATER PRESS OK" is displayed. Press the  icon (B9) again. The appliance is once again ready for use.
EMPTY WASTE COFFEE CONTAINER	<ul style="list-style-type: none"> The waste coffee container (A4) is too full or more than 3 days have passed since you last made coffee (this guarantees correct hygiene of the machine). 	<ul style="list-style-type: none"> Empty the waste coffee container and clean, then replace. Important: when removing the drip tray, the waste coffee container MUST be emptied, even if it is not completely full. If this is not done, when you make the next coffees, the waste coffee container may fill up more than expected and clog the machine.
INSERT WASTE COFFEE CONTAINER	<ul style="list-style-type: none"> After cleaning, the waste coffee container has not been replaced. 	<ul style="list-style-type: none"> Open the service door and insert the waste coffee container.

DISPLAYED MESSAGE	POSSIBLE CAUSE	REMEDY
ADD PRE-GROUND COFFEE	<ul style="list-style-type: none"> The "pre-ground coffee" function has been selected without placing any pre-ground coffee in the funnel. The funnel (A21) is blocked. 	<ul style="list-style-type: none"> Extract the appliance and place pre-ground coffee in the funnel. Empty the funnel with the help of a knife as described in the section "Cleaning the pre-ground coffee funnel".
PLEASE DESCALE!	<ul style="list-style-type: none"> The machine must be descaled. 	<ul style="list-style-type: none"> The descaling procedure described in the "Descaling" section needs to be performed as soon as possible.
LESS COFFEE	<ul style="list-style-type: none"> Too much coffee has been used. 	<ul style="list-style-type: none"> Select a milder taste or reduce the quantity of pre-ground coffee, then make the coffee again.
FILL BEAN CONTAINER	<ul style="list-style-type: none"> The coffee beans have run out. 	<ul style="list-style-type: none"> Fill bean container
INSERT BREWING UNIT	<ul style="list-style-type: none"> The brewing unit has not been replaced after cleaning. 	<ul style="list-style-type: none"> Insert the brewing unit as described in the section "Cleaning the brewing unit".
CLOSE DOOR	<ul style="list-style-type: none"> The service door is open 	<ul style="list-style-type: none"> Close the service door.
GENERAL ALARM!	<ul style="list-style-type: none"> The inside of the appliance is very dirty. 	<ul style="list-style-type: none"> Clean the inside of the appliance thoroughly, as described in the section "Cleaning and maintenance". If the message is still displayed after cleaning, contact a customer services.
REPLACE FILTER!	<ul style="list-style-type: none"> The water softener filter (A25) must be replaced. 	<ul style="list-style-type: none"> You must immediately replace the filter following the instructions in the section "Replacing the filter".

TROUBLESHOOTING

Below is a list of some of the possible malfunctions.

If the problem cannot be resolved as described, contact Customer Services.

PROBLEM	POSSIBLE CAUSE	REMEDY
The coffee is not hot	<ul style="list-style-type: none"> • The cups were not pre-heated. • The brewing unit has cooled down because 2/3 minutes have elapsed since the last coffee was made. • The temperature set is too low. 	<ul style="list-style-type: none"> • Warm the cups by rinsing them with hot water. • Before making coffee, preheat the brewing unit by selecting the RINSING function in the menu. • Change the set temperature (see paragraph "Changing coffee temperature").
The coffee is not creamy enough	<ul style="list-style-type: none"> • The coffee is ground too coarsely. • Wrong type of coffee 	<ul style="list-style-type: none"> • Turn the grinding adjustment knob one click anticlockwise towards "1" while the coffee mill is in operation (fig. 11). • Use a type of coffee for espresso coffee makers.
The coffee is delivered too slowly or a drop at a time.	<ul style="list-style-type: none"> • The coffee is ground too finely. 	<ul style="list-style-type: none"> • Turn the grinding adjustment knob one click clockwise towards "7" while the coffee mill is in operation (fig. 11). Continue one click at a time until coffee delivery is satisfactory. The effect is only visible after delivering two coffees.

PROBLEM	POSSIBLE CAUSE	REMEDY
The coffee is delivered too quickly.	<ul style="list-style-type: none"> The coffee is ground too coarsely. 	<ul style="list-style-type: none"> Turn the grinding adjustment knob one click anticlockwise towards "1" while the coffee mill is in operation (fig. 11). Avoid turning the grinding adjustment knob excessively otherwise when you select 2 cups, the coffee may be delivered a drop at a time. The effect is only visible after delivering two coffees.
Coffee does not come out of one of the spouts.	<ul style="list-style-type: none"> The spouts are blocked 	<ul style="list-style-type: none"> Clean the spouts with a toothpick (fig. 23).
The coffee does not come out of the spouts, but from around the service door (A2).	<ul style="list-style-type: none"> The holes in the spouts are clogged with dry coffee dust. The coffee guide (A3) inside the service door is blocked and cannot swing. 	<ul style="list-style-type: none"> If necessary, remove coffee deposits with a toothpick, sponge or stiff bristled kitchen brush (fig. 23). Thoroughly clean the coffee guide (A3), particularly near the hinges.
Water comes out of the spouts instead of coffee	<ul style="list-style-type: none"> The pre-ground coffee may be blocked in the funnel (A21). 	<ul style="list-style-type: none"> Clean the funnel (A21) with a wooden or plastic fork, clean the inside of the machine.

FOR AUSTRALIAN MARKET ONLY

Technika Service Department must be contacted...

- If in doubt about the operation of the appliance.
- If in doubt about the soundness of the appliance after removing it from its packaging.
- If the power supply cable has been damaged or needs to be replaced.
- If the appliance requires a service.
- If you need spare parts.

INDICE

INTRODUZIONE	7
Simbologia utilizzata nelle presenti istruzioni	7
Lettere tra parentesi	7
Problemi e riparazioni	7
SICUREZZA	7
Avvertenze fondamentali per la sicurezza	7
Uso conforme alla destinazione.....	8
Istruzioni per l'uso	8
DESCRIZIONE DELL'APPARECCHIO ..	8
Descrizione dell'apparecchio	8
Descrizione del pannello di controllo.....	8
OPERAZIONI PRELIMINARI	9
Controllo del trasporto	9
Installazione dell'apparecchio.....	9
Collegamento dell'apparecchio.....	9
SMALTIMENTO	9
INSTALLAZIONE AD INCASSO	10
PRIMA MESSA IN FUNZIONE DELL'APPARECCHIO	12
Installazione del filtro	12
Sostituzione del filtro	13
Rimozione del filtro	13
ACCENSIONE E PRERISCALDAMENTO	13
PREPARAZIONE DEL CAFFÈ (UTILIZZANDO IL CAFFÈ IN CHICCHI) ..	14
MODIFICA DELLA QUANTITÀ DI CAFFÈ IN TAZZA	15
REGOLAZIONE DEL MACINACAFFÈ ..	15
PREPARAZIONE DEL CAFFÈ ESPRESSO CON IL CAFFÈ PRE-MACINATO (AL POSTO DEI CHICCHI)	16
EROGAZIONE DI ACQUA CALDA	16
MODIFICA DELLA QUANTITÀ' DI ACQUA CALDA	16
PREPARAZIONE DEL CAPPUCCINO (UTILIZZANDO LA FUNZIONE VAPORE)	17
PULIZIA	17
Pulizia della macchina	17
Pulizia del contenitore di fondi di caffè.....	18
Pulizia della vaschetta raccogliogocce.....	18
Pulizia del serbatoio acqua.....	18
Pulizia dei beccucci erogatore	18
Pulizia dell'imbuto per l'introduzione del caffè premacinato.....	18
Pulizia dell'interno della macchina.....	18
Pulizia dell'infusore	18
MODIFICA E IMPOSTAZIONE DEI PARAMETRI DEL MENU'	19
Impostazione della lingua.....	19
Risciacquo	20
Modifica della durata dell'accensione	20
Impostazione dell'orologio	20
Impostazione dell'ora di accensione automatica	20
Modifica della temperatura del caffè.....	21
Programmazione della durezza dell'acqua	21
Programmazione caffè	21
Programmazione acqua.....	21
Decalcificazione.....	21
Ritorno alle impostazioni di fabbrica (reset)	22
Statistica	22
Avviso acustico	23
Regolazione contrasto.....	23
Filtro acqua	23
SPEGNIMENTO DELL'APPARECCHIO ..	23
DATI TECNICI	23
MESSAGGI VISUALIZZATI SUL DISPLAY	24
RISOLUZIONE DEI PROBLEMI	26

INTRODUZIONE

Simbologia utilizzata nelle presenti istruzioni

Le avvertenze importanti recano questi simboli. Errori nell'osservanza delle indicazioni riportate, possono provocare scosse elettriche, gravi lesioni, scottature, incendi, o danni all'apparecchio.



Pericolo!

La mancata osservanza può essere o è causa di lesioni da scossa elettrica con pericolo per la vita.



Attenzione!

La mancata osservanza può essere o è causa di lesioni o di danni all'apparecchio.



Pericolo Scottature!

La mancata osservanza può essere o è causa di scottature o di ustioni.



Nota Bene:

Informazioni importanti per l'utente.

Lettere tra parentesi

Le lettere tra parentesi corrispondono alla legenda riportata nella Descrizione dell'apparecchio (pag. 3).

Problemi e riparazioni

In caso di problemi, seguire le avvertenze riportate nei paragrafi "Messaggi visualizzati sul display" e "Risoluzione dei problemi".

Se queste risultassero inefficaci, si consiglia di consultare l'assistenza clienti. Per riparazioni, rivolgersi esclusivamente all'Assistenza Tecnica.

SICUREZZA

Avvertenze fondamentali per la sicurezza



Attenzione! Questo apparecchio è destinato esclusivamente all'uso domestico.

Non è previsto l'uso in:

- ambienti adibiti a cucina per il personale di negozi, uffici e altre aree di lavoro
- agriturismi
- hotel, motel e altre strutture ricettive
- affitta camere



Pericolo! Poiché l'apparecchio funziona a corrente elettrica, attenersi alle seguenti avvertenze di sicurezza:

- Non toccare l'apparecchio con le mani bagnate.
- Non toccare la spina con le mani bagnate.
- Assicurarsi che la presa di corrente utilizzata sia sempre liberamente accessibile, perché solo così si potrà staccare la spina all'occorrenza.
- **Se si vuole staccare la spina dalla presa, agire direttamente sulla spina. Non tirare mai il cavo perché potrebbe danneggiarsi.**
- **Per scollegare completamente l'apparecchio, premere l'interruttore generale (A23), posto sul fianco dell'apparecchio, in pos. 0.**
- In caso di guasti all'apparecchio, non tentare di ripararli. Spegnerne l'apparecchio utilizzando l'interruttore generale (A23), staccare la spina dalla presa e rivolgersi all'Assistenza Tecnica.
- **In caso di danni alla spina o al cavo di alimentazione, farli sostituire esclusivamente dall'Assistenza Tecnica, in modo da prevenire ogni rischio.**



Attenzione! Conservare il materiale dell'imballaggio (sacchetti di plastica, polistirolo espanso) fuori dalla portata dei bambini.



Attenzione! Non consentire l'uso dell'apparecchio a persone (anche bambini) con ridotte capacità psico-fisico-sensoriali, o con esperienza e conoscenze insufficienti, a meno che non siano attentamente sorvegliate e istruite da un responsabile della loro incolumità. Sorvegliare i bambini, assicurandosi che non giochino con l'apparecchio.



Pericolo Scottature! Questo apparecchio produce acqua calda e quando è in funzione può formarsi del vapore acqueo. Prestare atten-

zione di non venire in contatto con spruzzi d'acqua o vapore caldo. Utilizzare le manopole o le maniglie.



Attenzione! Non aggrapparsi alla macchina da caffè quando è stata estratta dal mobile. Non posare sull'elettrodomestico oggetti contenenti liquidi, materiali infiammabili o corrosivi, utilizzare il porta accessori per contenere gli accessori necessari alla preparazione del caffè (per esempio il misurino). Non posare sull'elettrodomestico oggetti grandi che possano bloccare il movimento oppure oggetti instabili.



Attenzione! Non utilizzare l'elettrodomestico quando è estratto dalla nicchia: attendere sempre che l'apparecchio sia inattivo prima di estrarlo. Fa eccezione la regolazione del macina caffè che deve essere effettuata con la macchina estratta (vedi capitolo "Regolazione del macina caffè").



Nota Bene: Utilizzare esclusivamente accessori e parti di ricambio originali o raccomandati dal costruttore.

Uso conforme alla destinazione

Questo apparecchio è costruito per la preparazione del caffè e per riscaldare bevande. Ogni altro uso è da considerarsi improprio. Questo apparecchio non è adatto per uso commerciale. Il costruttore non risponde per danni derivanti da un uso improprio dell'apparecchio. Questo apparecchio può essere installato su un forno ad incasso se quest'ultimo è dotato di ventilatore di raffreddamento sulla parte posteriore (potenza massima microonde 3kW).

Istruzioni per l'uso

Leggere attentamente queste istruzioni prima di utilizzare l'apparecchio.

- Conservare accuratamente queste istruzioni.
- Il mancato rispetto di queste istruzioni può essere fonte di lesioni e di danni all'apparecchio. Il costruttore non risponde per danni derivanti dal mancato rispetto di queste istruzioni per l'uso.



Nota Bene: L'apparecchio è dotato di una ventola di raffreddamento. Questa entra in funzione ogni qualvolta viene erogato un caffè, vapore o acqua calda. Dopo alcuni minuti la ventola si spegne automaticamente.

DESCRIZIONE DELL'APPARECCHIO

Descrizione dell'apparecchio

(pag. 3 - A)

- A1. Vassoio poggia tazze
- A2. Sportello di servizio
- A3. Convogliatore caffè
- A4. Contenitore per i fondi di caffè
- A5. Infusore
- A6. Luci vassoio poggiatezze
- A7. Tasto accensione/stand-by
- A8. Pannello di controllo
- A9. IEC connettore
- A10. Cappuccinatore estraibile
- A11. Ugello cappuccinatore
- A12. Serbatoio dell'acqua
- A13. Erogatore di caffè (regolabile in altezza)
- A14. Vaschetta raccogli gocce
- A15. Coperchio del contenitore per i chicchi
- A16. Contenitore per chicchi
- A17. Manopola regolazione del grado di macinatura
- A18. Sportello per imbuto caffè macinato
- A19. Misurino
- A20. Alloggio misurino
- A21. Imbuto per l'introduzione del caffè macinato
- A22. Cavo alimentazione
- A23. Interruttore generale ON/OFF
- A24. Vaschetta portaoggetti
- A25. Filtro addolcitore (optional)

Descrizione del pannello di controllo

(pag. 3 - B)





Nota Bene: Quando si stà utilizzando una

funzione, sul pannello di controllo si illuminano solo le icone relative ai comandi abilitati.

i Nota Bene: Per attivare le icone, è sufficiente un leggero tocco.

B1. Display: guida l'utente nell'utilizzo dell'apparecchio.

B2. Icona  per attivare oppure disattivare la modalità di impostazione dei parametri del menù

B3. Icona  per accendere/spengere la luce A6

B4. Icona  per selezionare il gusto del caffè

B5. Icona  per selezionare il tipo di caffè desiderato (espresso, tazza piccola, tazza media, tazza grande, mug)

B6. Icona  per uscire dalla modalità selezionata

B7-B8. Icone   per scorrere in avanti o indietro all'interno del menù e visualizzare le diverse modalità

B9. Icona  per confermare la funzione selezionata

B10. Icona  per erogare una tazza di caffè

B11. Icona  per erogare due tazze di caffè

B12. Icona  per erogare vapore

B13. Icona  per erogare acqua calda.

- Gli elementi dell'imballaggio (sacchetti in plastica, poliestere, ecc.) non devono essere lasciati alla portata dei bambini.
- Non installare mai l'elettrodomestico in ambienti in cui la temperatura possa arrivare a 0 °C.
- Personalizzare al più presto i valori di durezza dell'acqua seguendo le istruzioni "Programmazione della durezza dell'acqua".

Collegamento dell'apparecchio



Pericolo! Assicurarsi che la tensione della rete elettrica corrisponda a quella indicata nella targa dati sul fondo dell'apparecchio.

Collegare l'apparecchio solo ad una presa di corrente installata a regola d'arte avente una portata minima di 10A e dotata di efficiente messa a terra. In caso di incompatibilità tra la presa e la spina dell'apparecchio, fare sostituire la presa con un'altra di tipo adatto, da personale qualificato. Per il rispetto delle direttive in materia di sicurezza, durante l'installazione occorre utilizzare un interruttore onnipolare con una distanza minima tra i contatti di 3 mm. Non usare prese multiple o prolunghe.



Attenzione! I dispositivi di disconnessione devono essere previsti nella rete di alimentazione conformante alle regole di installazioni nazionali.

OPERAZIONI PRELIMINARI

Controllo del trasporto

Dopo aver tolto l'imballaggio, assicurarsi dell'integrità dell'apparecchio e della presenza di tutti gli accessori. Non utilizzare l'apparecchio in presenza di danni evidenti. Rivolgersi all'Assistenza Tecnica.

Installazione dell'apparecchio



Attenzione!

- L'installazione deve essere effettuata da un tecnico qualificato secondo le norme locali in vigore (vedi par. "Installazione ad incasso").

SMALTIMENTO



Gli apparecchi elettrici non devono essere smaltiti assieme ai rifiuti domestici. Gli apparecchi che recano questo simbolo  sono soggetti alla Direttiva europea 2002/96/CE. Tutti gli apparecchi elettrici ed elettronici dismessi devono essere smaltiti separatamente dai rifiuti domestici, conferendoli agli appositi centri previsti dallo Stato. Smaltendo correttamente l'apparecchio dismesso, si eviteranno danni all'ambiente e rischi per la salute delle persone. Per ulteriori informazioni sullo smaltimento dell'apparecchio dismesso rivolgersi all'Amministrazione comunale, all'Ufficio smaltimento o al negozio dove è stato acquistato l'apparecchio.

INSTALLAZIONE AD INCASSO

Verificare le misure minime necessarie per la corretta installazione dell'elettrodomestico.

La macchina da caffè deve essere installata in una colonna e tale colonna deve essere saldamente fissata alla parete con staffe commerciali.

Attenzione:

- Importante: qualsiasi intervento di installazione o manutenzione deve essere eseguito con l'apparecchio scollegato dalla rete elettrica.
- I mobili della cucina a diretto contatto con l'apparecchio devono essere resistenti al calore (min. 65°C).
- Per assicurare una corretta ventilazione, lasciare un'apertura sul fondo del mobile (vedi misure in figura).

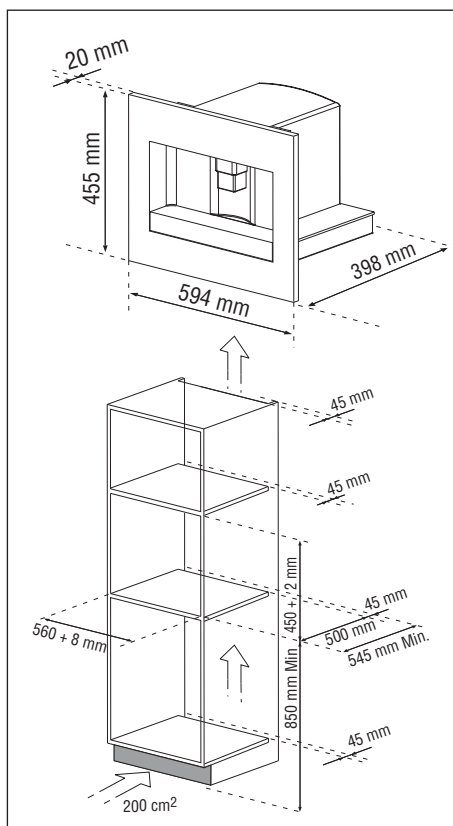
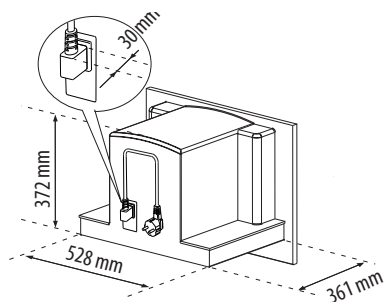

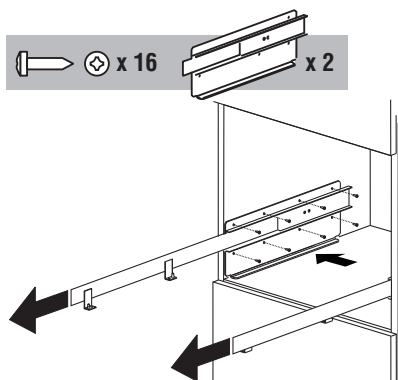

Posizionare le guide sulle superfici laterali del mobile, come mostrato in figura. Fissare le guide con le apposite viti, poi estrarle completamente. Nel caso in cui la macchina da caffè sia installata sopra un "Cassetto scaldavivande" utilizzare la superficie superiore di quest'ultimo come riferimento per il posizionamento delle guide. In tal caso non sarà presente il ripiano di appoggio.

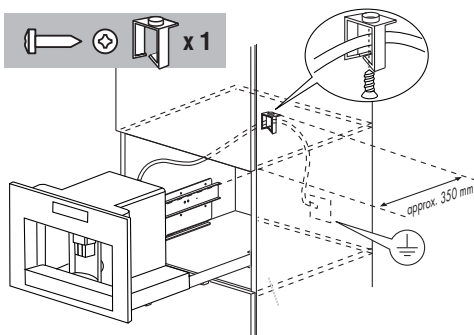

Fissare il cavo di alimentazione con l'apposita clip. Il cavo di alimentazione deve essere lungo quanto basta da permettere l'estrazione dell'apparecchio dal mobile durante la fase di riempimento del serbatoio chicchi caffè. **La messa a terra è obbligatoria a termini di legge. Il collegamento elettrico deve essere effettuato da un tecnico qualificato secondo le istruzioni.**

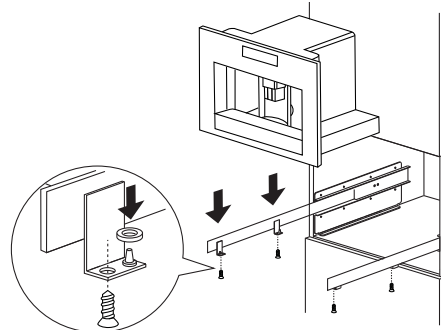



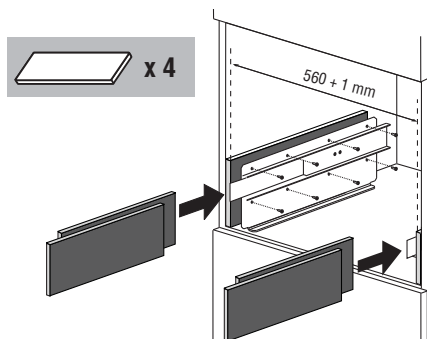

Collocare l'elettrodomestico sulle guide assicurandosi che i perni siano ben inseriti nelle apposite sedi nel fissarlo con le viti in dotazione. In caso di aggiustamenti in altezza dell'apparecchio, utilizzare gli spaziatori circolari in dotazione.



In caso di correzioni dell'allineamento dell'apparecchio, posizionare gli spaziatori in dotazione sotto o ai lati del supporto.

PRIMA MESSA IN FUNZIONE DELL'APPARECCHIO

- La macchina è stata controllata in fabbrica utilizzando del caffè per cui è del tutto normale trovare qualche traccia di caffè nel macinino.
 - Personalizzare al più presto la durezza dell'acqua seguendo la procedura "Programmazione della durezza acqua".
1. Collegare l'apparecchio alla rete elettrica. Impostare la lingua desiderata.
 2. Per impostare la lingua, utilizzare le icone   (B7 e B8) fino a selezionare quella desiderata (fig. 2). Quando il display visualizza il messaggio: "PREMERE OK PER INSTALLARE ITALIANO", tenere premuta per almeno 3 secondi l'icona  (B9) (fig. 3) fino a quando appare il messaggio "ITALIANO INSTALLATO". Se si seleziona una lingua non desiderata, seguire le indicazioni descritte nel cap. "Impostazione della lingua". Se invece la vostra lingua non è disponibile, selezionatene una tra quelle presenti nel display. Nelle istruzioni viene presa come riferimento la lingua inglese. Procedere quindi con le istruzioni indicate dal display:
 3. Dopo 5 secondi, la macchina visualizza "RIEMPIRE SERBATOIO": estrarre il serbatoio (fig. 4), sciacquarlo e riempirlo con acqua fresca senza superare la linea MAX. Reinserrarlo spingendolo a fondo. All'interno del serbatoio è possibile installare un filtro addolcitore (fig. 29).
 4. Posizionare poi una tazza sotto il cappuccinatore (fig. 5). La macchina visualizza "ACQUA CALDA PREMERE OK". Premere l'icona  (B9) (fig. 3) e dopo pochi secondi, un po' di acqua fuoriesce dal cappuccinatore.
 5. La macchina visualizza "SPEGNIMENTO IN CORSO... ATTENDERE PREGO" e si spegne.
 6. Estrarre l'elettrodomestico tirandolo verso l'esterno, utilizzando le apposite maniglie (fig. 6); aprire il coperchio, riempire il contenitore di caffè in grani, poi chiudere il coper-

chio e spingere l'elettrodomestico verso l'interno.

Ora la macchina da caffè è pronta per il normale utilizzo.



Attenzione! Non introdurre mai caffè pre-macinato, caffè liofilizzato, chicchi caramellati nonché oggetti che possono danneggiare la macchina.



Nota Bene: Al primo utilizzo è necessario fare 4-5 caffè e 4-5 cappuccini prima di ottenere un buon risultato.



Nota Bene: Ad ogni accensione utilizzando l'interruttore ON/OFF principale (A23) l'elettrodomestico avvierà una funzione di AUTO-DIAGNOSI per poi spegnersi, per accenderlo nuovamente premere il tasto (A7) accensione/stand-by (fig. 1).

Installazione del filtro

Alcuni modelli hanno in dotazione il filtro addolcitore: esso migliora la qualità dell'acqua e assicura una vita più lunga all'apparecchio. Per installarlo, procedere nel seguente modo:

1. Togliere il filtro dalla confezione;
2. Scorrere il cursore del datario (vedi fig. 29) affinché siano visualizzati i mesi di utilizzo



Nota Bene: il filtro ha durata pari a due mesi se l'apparecchio è stato utilizzato normalmente, se invece la macchina rimane inutilizzata con il filtro installato, ha durata pari a 3 settimane al massimo.

3. Riempire il serbatoio con un pò d'acqua fino a raggiungere il livello indicato nella figura:





4. Inserire il filtro nel serbatoio acqua e premerlo finchè tocchi il fondo del serbatoio stesso (vedi figura 29);
5. Riempire il serbatoio e inserirlo nella macchina;

6. Posizionare sotto il cappuccinatore un contenitore (capacità: min. 100ml).
7. Premere l'icona  (B2) per entrare nel menù;
8. Premere le icone   (B7) e (B8) finché appare sul display la scritta "INSTALLA FILTRO";
9. Premere l'icona  (B9);
10. Il display visualizza la scritta "INSTALLA FILTRO CONFERMARE".
11. Premere l'icona  (B9) per confermare la selezione (oppure  (B6) per annullare): il display visualizza "ACQUA CALDA PREMERE OK".
12. Premere l'icona  (B9): l'apparecchio inizia l'erogazione di acqua calda ed il display visualizza la scritta "ATTENDERE PREGO". Completata l'erogazione, l'apparecchio torna automaticamente a visualizzare le modalità di base impostate.

 **Nota Bene:** La macchina può richiedere di ripetere più volte l'operazione; questo fino a completa eliminazione dell'aria nel circuito idraulico.

Sostituzione del filtro ("Resetta filtro")

Quando il display visualizza "SOSTITUIRE FILTRO", o quando sono trascorsi i due mesi di durata (vedi datario), è necessario procedere alla sostituzione del filtro:



1. Estrarre il filtro esaurito;
2. Togliere il nuovo filtro dalla confezione.
3. Scorrere il cursore del datario (vedi fig. 29) affinché siano visualizzati i mesi di utilizzo (il filtro ha durata pari a due mesi);
4. Inserire il filtro nel serbatoio acqua e premerlo finché tocchi il fondo del serbatoio stesso (vedi figura 29);
5. Riempire il serbatoio e inserirlo nella macchina;
6. Ruotare verso l'esterno il cappuccinatore e posizionarvi sotto un contenitore (capacità: min. 100ml).
7. Premere l'icona  (B2) per entrare nel menù;
8. Premere le icone   (B7) e (B8) finché appare sul display la scritta "RESETTA

FILTRO";

9. Premere l'icona  (B9);
10. Il display visualizza la scritta "RESETTA FILTRO CONFERMARE"
11. Premere l'icona  (B9) per confermare la selezione (oppure  (B6) per annullare l'operazione); il display visualizza "ACQUA CALDA PREMERE OK".
12. Premere l'icona  (B9): l'apparecchio inizia l'erogazione di acqua calda ed il display visualizza la scritta "ATTENDERE PREGO...". Completata l'erogazione, l'apparecchio torna automaticamente a visualizzare le modalità di base impostate.

Rimozione del filtro

Per utilizzare l'apparecchio senza il filtro, è necessario rimuoverlo e segnalarne la rimozione; procedere come segue:

1. Premere l'icona  (B2) per entrare nel menù;
2. Premere le icone   (B7) e (B8) finché appare sul display la scritta "INSTALLA FILTRO *";
3. Premere l'icona  (B9);
4. Il display visualizza la scritta "INSTALLA FILTRO * CONFERMARE".
5. Premere l'icona  (B6).
6. Dopo che è scomparso l'asterisco in alto a destra del display, premere  (B6) per uscire dal menù.

 **Nota Bene!** Utilizzare esclusivamente filtri raccomandati dal costruttore. L'utilizzo di filtri non idonei, può causare danni all'apparecchio.

ACCENSIONE E PRERISCALDAMENTO

Ogni volta che si accende l'apparecchio, viene eseguito automaticamente un ciclo di preriscaldamento e di risciacquo che non può essere interrotto. L'apparecchio è pronto all'uso solo dopo l'esecuzione di questo ciclo.







Pericolo scottature! Durante il risciac-

quo, dai beccucci dell'erogatore del caffè fuoriesce un po' di acqua calda.

Per accendere l'apparecchio, premere il tasto (A7) accensione/stand-by (fig. 1): sul display compare il messaggio "RISCALDAMENTO ATTENDERE PREGO". Una volta completato il riscaldamento, l'apparecchio mostra un altro messaggio: "RISCIACQUO". L'apparecchio è in temperatura quando sul display compare il messaggio "TAZZA MEDIA GUSTO NORMALE". Dopo circa 2 minuti, se non viene premuta nessuna icona, sul display compare l'ora (se impostata) (vedi paragrafo "Impostazione dell'orologio"). Se invece l'ora non è stata impostata, la macchina visualizza le ultime funzioni impostate. Premendo una qualsiasi icona ricompare il messaggio "TAZZA MEDIA GUSTO NORMALE"; la macchina è di nuovo pronta per erogare caffè.

PREPARAZIONE DEL CAFFÈ (UTILIZZANDO IL CAFFÈ IN CHICCHI)

1. La macchina è impostata in fabbrica per erogare caffè con gusto normale. È possibile richiedere caffè con gusto extra-leggero, leggero, forte, oppure extra-forte, con opzione del caffè premacinato. Per scegliere il gusto desiderato, premere l'icona  (B4) (fig. 7): il gusto desiderato del caffè è visualizzato sul display.
2. Mettere sotto i beccucci dell'erogatore una tazza se si vuole 1 caffè (fig. 8) oppure 2 tazze per 2 caffè (fig. 9). Per ottenere una migliore crema, avvicinare il più possibile l'erogatore caffè alle tazze abbassandolo (fig. 10).
3. Premere l'icona  (B5) (fig. 11) per selezionare il tipo di caffè desiderato: espresso, tazza piccola, tazza media, tazza grande, mug. A questo punto premere l'icona  (B10) (fig. 12) se si desidera fare un caffè, se, invece, si desidera fare 2 caffè premere l'icona  (B11) (fig. 13). A questo punto la macchina macina i chicchi ed esegue l'erogazione nella tazza. Una volta ottenuta la

quantità di caffè pre-impostata, la macchina ferma l'erogazione automaticamente e provvede all'espulsione della pasticca esausta di caffè nel contenitore dei fondi.

4. Dopo qualche secondo, la macchina è nuovamente pronta all'uso.
5. Per spegnere la macchina, premere il tasto (A7) accensione/stand-by (fig. 1). (Prima di spegnersi, la macchina esegue automaticamente un risciacquo: fate attenzione a non scottarvi).

NOTA 1: Se il caffè fuoriesce a gocce oppure non esce del tutto, vedi cap. "Regolazione del macinacaffè".

NOTA 2: Se il caffè fuoriesce troppo velocemente e la crema non è soddisfacente, vedi cap. "Regolazione del macinacaffè".

NOTA 3: Consigli per ottenere il caffè più caldo:

- Operare come descritto nel capitolo "Modifica e impostazioni dei parametri del menù", funzione "Risciacquo".
- Non utilizzare tazzine troppo spesse altrimenti assorbono troppo calore, a meno che non siano pre-riscaldate.
- Utilizzare tazzine preventivamente riscaldate risciacquandole con dell'acqua calda.

NOTA 4: In qualsiasi momento è possibile interrompere l'erogazione di caffè ripremendo l'icona selezionata precedentemente che rimane illuminata durante l'operazione.

NOTA 5: Appena terminata l'erogazione, se si vuole aumentare la quantità di caffè nella tazza, tenere premuta l'icona precedentemente selezionata entro 3 secondi dal termine dell'erogazione).

NOTA 6: quando il display visualizza il messaggio: "RIEMPIRE SERBATOIO!" è necessario riempire il serbatoio dell'acqua altrimenti la macchina non eroga il caffè. (E' normale che ci sia ancora un po' di acqua nel serbatoio).

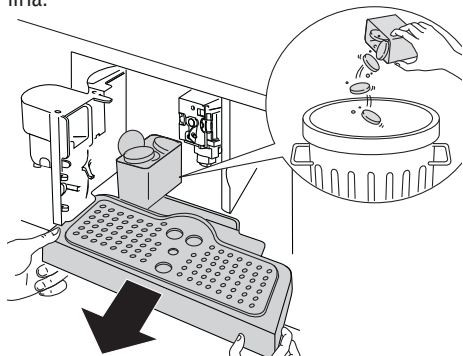

NOTA 7: la macchina dopo ogni 14 caffè singoli (o 7 doppi), visualizza il messaggio: "SVUOTARE CONTENITORE FONDI CAFFÈ". **L'apparecchio segnala la necessità di svuotare il contenitore anche se non è pieno qualora siano trascorse 72 ore dalla prima erogazione eseguita (perchè il conteggio delle 72 ore sia eseguito correttamente, la**

macchina non deve essere mai spenta con l'interruttore generale in posizione 0). Per eseguire la pulizia aprire lo sportello di servizio sulla parte anteriore tirando l'erogatore (fig. 16), estrarre quindi la vaschetta raccogliogocce (fig. 17) e pulirla.



Nel momento in cui si effettua la pulizia, **estrarre sempre completamente il vassoio raccogliogocce**.

⚠ Attenzione! quando si estrae la vaschetta raccogliogocce è **OBBLIGATORIO** svuotare sempre il contenitore fondi caffè. Se questa operazione non è effettuata può succedere che la macchina si intasi.

NOTA 8: mentre la macchina sta erogando caffè, non si deve mai estrarre il serbatoio dell'acqua. Infatti se questo venisse estratto, la macchina poi non riesce più a fare il caffè e visualizza il messaggio: "MACINATO TROPPO FINE REGOLARE MACININO PREMERE OK" e poi "RIEMPIRE SERBATOIO". Quindi verificare il livello dell'acqua nel serbatoio e reinsertirlo. Per riavviare la macchina premere l'icona  (B9) e il display visualizza "ACQUA CALDA PREMERE OK". Premere l'icona  (B9) entro alcuni secondi, far defluire l'acqua dal cappuccinatore per circa 30 secondi. Completata l'erogazione, l'apparecchio torna automaticamente a visualizzare le modalità di base impostate.

i Nota Bene: La macchina può richiedere di ripetere più volte l'operazione; questo fino a completa eliminazione dell'aria nel circuito idraulico.













i Nota Bene: Se l'operazione sopra descritta non viene eseguita correttamente o se la macchina viene spenta, il display potrebbe tornare a visualizzare le modalità di base impostate, anche se in realtà il problema persiste.

MODIFICA DELLA QUANTITÀ DI CAFFÈ IN TAZZA

La macchina è stata pre-impostata in fabbrica per erogare automaticamente le seguenti tipologie di caffè:

- espresso
- tazza piccola
- tazza media
- tazza grande
- mug

Per modificare la quantità, procedere nel seguente modo:

- Premere l'icona  (B2) per entrare nel menù (fig. 15), premere le icone   (B7) e (B8) (fig. 2) fino a selezionare il messaggio "PROGRAMM. CAFFÈ".
- Premere l'icona  (B9).
- Selezionare il tipo di caffè che si desidera modificare premendo le icone   (B7) e (B8).
- Premere l'icona  (B9) per confermare il tipo di caffè che si desidera modificare.
- Utilizzare le icone   (B7) e (B8), per modificare la quantità di caffè desiderata. La barra progressiva indica la quantità di caffè selezionata.
- Ripremere l'icona  (B9) per confermare (oppure l'icona  (B6) per annullare l'operazione).
- Premere due volte l'icona  (B6) (fig. 18) per uscire dal menù.

A questo punto la macchina è riprogrammata secondo le nuove impostazioni e pronta all'uso.

REGOLAZIONE DEL MACINACAFFÈ

Il macinacaffè non deve essere regolato, perché

è già stato preimpostato in fabbrica; tuttavia se l'erogazione dovesse risultare troppo veloce o troppo lenta (a gocce), è necessario effettuare una correzione con la manopola di regolazione del grado di macinatura (fig. 14).

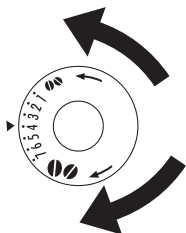

⚠️ Attenzione! La manopola di regolazione deve essere ruotata solo mentre il macinacaffè è in funzione.



Per ottenere un'erogazione del caffè più lenta e migliorare l'aspetto della crema, girare di uno scatto in senso antiorario (=caffè macinato più fine). Per ottenere un'erogazione del caffè più veloce

(non a gocce), girare di uno scatto in senso orario (=caffè macinato più grosso).

PREPARAZIONE UTILIZZANDO CAFFÈ PRE-MACINATO

- Premere l'icona  (B4) (fig. 7) e selezionare la funzione caffè pre-macinato.
- Estrarre l'apparecchio tirandolo verso l'esterno; avendo cura di utilizzare le apposite maniglie.
- Sollevare il coperchietto al centro, inserire nell'imbuto un misurino di caffè pre-macinato (fig. 19); spingere l'elettrodomestico verso l'interno e procedere poi come descritto nel cap. "Preparazione del caffè (utilizzando il caffè in chicchi)". NB: E' possibile eseguire un solo caffè alla volta, premendo l'icona  (B10) (fig. 12).
- Se, dopo aver fatto funzionare la macchina utilizzando caffè pre-macinato, si vuole ritornare a fare caffè utilizzando i chicchi, è necessario disattivare la funzione caffè pre-macinato ripremendo l'icona  (B4) (fig. 7).

NOTA 1: Non introdurre mai il caffè pre-macinato a macchina spenta, per evitare che si disperda al-

l'interno della macchina.





NOTA 2: Non inserire mai più di 1 misurino altrimenti la macchina poi non farà il caffè.

NOTA 3: Utilizzare solo il misurino dato in dotazione.

NOTA 4: Inserire nell'imbuto solo caffè pre-macinato per macchine da caffè espresso.



NOTA 5: Se versando più di un misurino di caffè pre-macinato l'imbuto si intasa, utilizzare un coltello per far scendere il caffè (fig. 21), quindi togliere e pulire l'infusore e la macchina come descritto nel cap. "Pulizia dell'infusore".

EROGAZIONE DI ACQUA CALDA







- Controllare sempre che la macchina sia pronta all'uso.
- Posizionare il cappuccinatore verso il centro e posizionarvi sotto un contenitore (fig. 5).
- Premere l'icona  (B13) (fig. 20). La macchina visualizza il messaggio "ACQUA CALDA PREMERE OK". Premere l'icona  (B9) e l'acqua calda esce dal cappuccinatore riempiendo il contenitore sottostante (Non erogare acqua calda per più di 2 minuti di seguito). Per interrompere, premere l'icona  (B13) o l'icona  (B6). La macchina interrompe l'erogazione una volta raggiunta la quantità pre-impostata.

MODIFICA DELLA QUANTITÀ' DI ACQUA CALDA







La macchina è stata impostata in fabbrica per erogare automaticamente 200ml di acqua calda. Se si desidera modificare queste quantità, procedere nel seguente modo:



- Posizionare sotto il cappuccinatore un contenitore (fig. 5).
- Premere l'icona  (B2) per entrare nel menù (fig. 15) o poi premere le icone  (B7) e (B8) (fig. 2) fino a selezionare il

messaggio “PROGRAMM. ACQUA”.



- Premere l'icona  (B9) per confermare.
- Selezionare la quantità d'acqua desiderata premendo le icone   (B7) e (B8). La barra progressiva indica la quantità di acqua selezionata.
- Premere l'icona  (B9) per confermare (oppure l'icona  (B6) per annullare l'operazione).
- Premere due volte l'icona  (B6) (fig. 18) per uscire dal menù.
- A questo punto la macchina è riprogrammata secondo le nuove impostazioni e pronta all'uso.

PREPARAZIONE DEL CAPPUCCINO (UTILIZZANDO LA FUNZIONE VAPORE)

- Ruotare il cappuccinatore verso il centro (fig. 5).
- Prendere un contenitore e riempirlo di circa 100 grammi di latte per ogni cappuccino da preparare e posizionarlo sotto il cappuccinatore. Scegliendo la dimensione del contenitore, considerare che il volume del latte raddoppia o triplica. Si raccomanda l'utilizzo di latte parzialmente scremato a temperatura frigorifero.
- Premere l'icona  (B12) (fig. 22). Il display visualizza “VAPORE PREMERE OK”.
- Premere l'icona  (B9).
- Per interrompere l'uscita di vapore premere di nuovo l'icona  (B12) oppure l'icona  (B6).
- Immergere il cappuccinatore nel recipiente contenente il latte (fig. 23), avendo cura di non immergerlo oltre la metà della sua lunghezza. Premere l'icona  (B12) (attenzione a non scottarsi) e premere l'icona  (B9). Il vapore esce dal cappuccinatore. Per ottenere una schiuma più cremosa, immergere il cappuccinatore nel latte e muovere il contenitore con movimenti lenti dal basso verso l'alto. (Non erogare vapore per più di 2 minuti di seguito).

- Raggiunta la temperatura desiderata, interrompere l'emissione di vapore premendo di nuovo l'icona  (B12) oppure l'icona  (B6).
- Preparare il caffè come sopra descritto, utilizzando tazze sufficientemente grandi, riempiendole poi con il latte schiumato preparato precedentemente.

IMPORTANTE: pulire sempre il sistema cappuccino immediatamente dopo averlo utilizzato. Procedere come descritto di seguito:

- Premere l'icona  (B12) e poi premere l'icona  (B9) per rilasciare per alcuni secondi una piccola quantità di vapore. Ciò svuoterà l'erogatore vapore di ogni traccia residua di latte.
- **IMPORTANTE: a garanzia dell'igiene, si raccomanda di seguire questa procedura ad ogni preparazione di cappuccino per evitare ristagni nel circuito del latte.**
- Attendere che il cappuccinatore si raffreddi poi, tenere ferma con una mano la leva del cappuccinatore, svitare con l'altra il cappuccinatore stesso ruotandolo in senso antiorario ed estraendolo verso il basso (fig. 24).
- Estrarre l'ugello del cappuccinatore tirandolo verso il basso.
- Lavare il cappuccinatore e l'ugello con cura, in acqua calda.
- Accertarsi che i due fori illustrati nella figura 25 non siano otturati. Se necessario, pulirli con uno spillo.
- Riposizionare l'ugello inserendolo verso l'alto nel cappuccinatore.
- Riposizionare il cappuccinatore spingendolo verso l'alto e ruotandolo in senso orario.

PULIZIA

Pulizia della macchina

Per la pulizia della macchina non usare solventi o detersivi abrasivi. E' sufficiente un panno umido e morbido. Tutti i componenti della macchina non devono essere MAI lavati in lavastoviglie.

Le seguenti parti della macchina devono essere pulite periodicamente:

- Contenitore dei fondi di caffè (A4).
- Vaschetta raccogli gocce (A14).
- Serbatoio dell'acqua (A12).
- Beccucci dell'erogatore caffè (A13), dell'ugello acqua calda (A11), del cappuccinatore (A10).
- Imbuto per introduzione del caffè pre-macinato (A21).
- L'interno della macchina, accessibile dopo aver aperto lo sportello di servizio (A2).
- L'infusore (A5).

Pulizia del contenitore dei fondi di caffè

Quando sul display compare la scritta "SVUOTARE CONTENITORE FONDI!", è necessario svuotarlo e pulirlo. Per eseguire la pulizia:

- aprire lo sportello di servizio sulla parte anteriore (fig. 16), estrarre quindi la vaschetta raccogli-gocce (fig. 17), e pulirla.
- Pulire accuratamente il contenitore dei fondi.



Attenzione! quando si estrae la vaschetta raccogli-gocce è **obbligatorio** svuotare sempre il contenitore fondi caffè.

Pulizia della vaschetta raccogli gocce



Attenzione! Se la vaschetta raccogli gocce non viene svuotata, l'acqua può traboccare. Questo può danneggiare la macchina.

La vaschetta raccogli-gocce è provvista di un indicatore galleggiante (di colore rosso) del livello dell'acqua contenuta (fig. 27). Prima che questo indicatore cominci a sporgere dal vassoio poggiatezze, è necessario svuotare la vaschetta e pulirlo.

Per rimuovere la vaschetta:

1. Aprire lo sportello di servizio (fig. 16).
2. Estrarre la vaschetta raccogli gocce ed il contenitore dei fondi di caffè (fig. 17).
3. Pulire la vaschetta raccogli gocce ed il contenitore fondi (A4).
4. Reinserrire la vaschetta con il contenitore dei fondi di caffè (A4).

5. Chiudere lo sportello di servizio.

Pulizia del serbatoio acqua

1. Pulire periodicamente (circa una volta al mese) il serbatoio acqua (A12) con un panno umido e un po' di detersivo delicato.
2. Rimuovere accuratamente i residui di detersivo.

Pulizia dei beccucci erogatore

1. Pulire i beccucci periodicamente, servendosi di una spugna (fig. 28).
2. Controllare periodicamente che i fori dell'erogatore caffè non siano otturati. Se necessario, rimuovere i depositi di caffè con uno stuzzicadenti (fig. 26).

Pulizia dell'imbuto per l'introduzione del caffè pre-macinato

- Controllare periodicamente (circa una volta al mese) che l'imbuto per l'introduzione del caffè pre-macinato non sia otturato (fig. 21).



Pericolo! Prima di eseguire qualsiasi operazione di pulizia, la macchina deve essere spenta premendo l'interruttore generale (A23) e scollegata dalla rete elettrica.

Non immergere mai la macchina nell'acqua.

Pulizia dell'interno della macchina

1. Controllare periodicamente (circa una volta alla settimana) che l'interno della macchina non sia sporco. Se necessario, rimuovere i depositi di caffè con una spugna.
2. Aspirare i residui con un aspirapolvere (fig. 30).

Pulizia dell'infusore

L'infusore dev'essere pulito almeno una volta al mese.



Attenzione! L'infusore (A5) non può essere estratto quando la macchina è accesa. Non

tentare di togliere l'infusore con forza.

1. Assicurarsi che la macchina abbia eseguito correttamente lo spegnimento (vedi "Spegnimento").
2. Aprire lo sportello di servizio (fig. 16).
3. Estrarre la vaschetta raccogli gocce ed il contenitore dei fondi (fig. 17).
4. Premere verso l'interno i due tasti di sgancio di colore rosso e contemporaneamente estrarre l'infusore verso l'esterno (fig. 31).

⚠ Attenzione! Pulire l'infusore senza usare detersivi perché l'interno del pistone è trattato con un lubrificante che verrebbe asportato dal detersivo.

5. Immergere per circa 5 minuti l'infusore in acqua e poi risciacquarlo.
6. Dopo la pulizia, reinserire l'infusore (A5) infilandolo nel supporto e sul perno in basso;

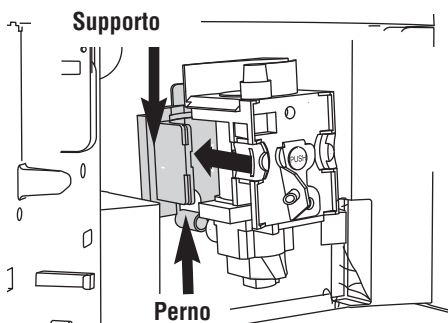

quindi premere sulla scritta PUSH fino a sentire il clic di aggancio.

i Nota Bene! Se l'infusore è difficile da inserire, è necessario (prima dell'inserimento) portarlo alla giusta dimensione premendolo con forza contemporaneamente dalla parte inferiore e superiore come indicato in figura.

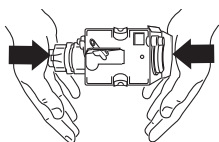

7. Una volta inserito, assicurarsi che i due tasti

rossi siano scattati verso l'esterno.

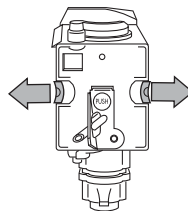

8. Reinscrivere la vaschetta raccogli gocce con il contenitore fondi.
9. Chiudere lo sportello di servizio.

MODIFICA E IMPOSTAZIONE DEI PARAMETRI DEL MENU'

Quando la macchina è pronta all'uso, è possibile operare all'interno del menù per modificare i seguenti parametri o funzioni:

- Scegli lingua
- Risciacquo
- Spegni dopo
- Imposta orologio
- Ora accensione
- Auto accensione
- Temperatura
- Durezza acqua
- Programm. caffè
- Programm. acqua
- Decalcificazione
- Valori fabbrica
- Statistica
- Installa filtro
- Reseta filtro
- Avviso acustico
- Contrasto

Impostazione della lingua

Se si desidera modificare la lingua sul display, procedere come segue:

- Premere l'icona  (B2) per entrare nel menù; sul display compare "SCEGLI LINGUA".
- Premere l'icona  (B9).
- Premere le icone  (B7) e (B8) finché la macchina visualizza la lingua deside-

rata.





- Premere l'icona  (B9) per confermare.
- Premere l'icona  (B6) per uscire dal menù.

i **Nota Bene!** Se per errore si seleziona una lingua non desiderata è possibile accedere direttamente al menù per modificare questo parametro:

- Tenere premuta l'icona  (B2) per almeno 7 secondi fino a quando la macchina visualizza le varie lingue.
- Scegliere la lingua desiderata operando come descritto nel paragrafo "Prima messa in funzione dell'apparecchio".

Risciacquo

Questa funzione serve per ottenere un caffè più caldo. Operare come segue:

- Se, appena accesa la macchina, si richiede una tazza piccola di caffè (inferiore a 60cc), usare l'acqua calda del risciacquo per pre-riscaldare la tazza.
- Se invece dall'ultimo caffè fatto, sono trascorsi più di 2/3 minuti, prima di richiedere un altro caffè è necessario pre-riscaldare l'infusore premendo prima l'icona  (B2) per entrare nel menù e poi le icone   (B7) e (B8) fino a selezionare la funzione "RISCIACQUO". Premere l'icona  (B9). Il display visualizza "RISCIACQUO CONFERMARE".

Premere ancora l'icona  (B9).





Lasciare poi defluire l'acqua nella vaschetta raccogliogocce sottostante, oppure utilizzare questa acqua per riempire (e poi svuotare) la tazzina che si utilizzerà poi per il caffè in modo da pre-riscaldarla.

Modifica della durata dell'accensione











La macchina è stata pre-impostata in fabbrica per spegnersi automaticamente dopo 30 minuti dall'ultimo utilizzo. Per modificare questo intervallo (max 120 min.), operare come segue:

- Premere l'icona  (B2) per entrare nel menù e poi premere le icone  

(B7) e (B8) finché la macchina visualizza il messaggio "SPEGNI DOPO".









- Premere l'icona  (B9) per confermare.
- Premere le icone   (B7) e (B8) per stabilire dopo quanto tempo l'apparecchio si deve spegnere (1/2 ora, 1 ora, 2 ore).
- Premere l'icona  (B9) per confermare.
- Premere l'icona  (B6) per uscire.

Impostazione dell'orologio

- Premere l'icona  (B2) per entrare nel menù e poi premere le icone   (B7) e (B8) finché la macchina visualizza il messaggio "IMPOSTA OROLOGIO".
- Premere l'icona  (B9).
- Per impostare l'ora, utilizzare le icone   (B7) e (B8) e premere l'icona  (B9) per confermare.
- Per impostare i minuti, utilizzare le icone   (B7) e (B8) e premere l'icona  (B9) per confermare.
- Premere l'icona  (B6) per uscire dal menù.

Impostazione dell'ora di accensione automatica



Questa funzione permette di programmare l'ora alla quale la macchina si accenderà automaticamente.

- Assicurarsi che l'orologio della macchina sia stato impostato.
- Premere l'icona  (B2) per entrare nel menù e poi premere le icone   (B7) e (B8) finché la macchina visualizza il messaggio "ORA ACCENSIONE".
- Premere l'icona  (B9).
- Per impostare l'ora di accensione automatica utilizzare le icone   (B7) e (B8) e premere l'icona  (B9) per confermare.
- Per impostare i minuti utilizzare le icone   (B7) e (B8) e premere l'icona  (B9) per confermare.
- Per attivare la funzione accensione automatica, premere le icone   (B7) e (B8) finché la macchina visualizza il messaggio "AUTO ACCENSIONE".

- Premere l'icona  (B9) per confermare. Sul display compare il simbolo .
- Premere l'icona  (B6) per uscire dal menù.
- Per disattivare la funzione accensione automatica, premere l'icona  (B2) e poi premere le icone   (B7) e (B8) finché la macchina visualizza il messaggio "AUTO ACCENSIONE".
Premere l'icona  (B9). Sul display compare "CONFERMARE". Premere  per disattivare ed il simbolo  scompare.

Modifica della temperatura del caffè



Per modificare la temperatura del caffè erogato, procedere come segue:





- Premere l'icona  (B2) per entrare nel menù e poi premere le icone   (B7) e (B8) finché la macchina visualizza il messaggio "TEMPERATURA";
- Premere l'icona  (B9).
- Premere le icone   (B7) e (B8) per selezionare la temperatura del caffè desiderata: bassa, media, alta.
- Premere l'icona  (B9) per confermare la temperatura scelta.
- Premere l'icona  (B6) per uscire dal menù.

Programmazione della durezza dell'acqua

Volendo è possibile allungare questo periodo di funzionamento e quindi rendere meno frequente l'operazione di decalcificazione programmando la macchina in base al reale contenuto di calcare presente nell'acqua utilizzata. Procedere nel seguente modo:

- dopo aver tolto dalla propria confezione, la striscia reattiva "Total hardness test" (allegata a pag. 2), immergerla completamente nell'acqua per qualche secondo. Poi estrarla e attendere 30 secondi circa (fino a quando cambia colore e si formano dei quadratini rossi).
- accendere la macchina premendo il tasto accensione/stand-by (A7).
- Premere l'icona  (B2) per entrare nel

menù e poi premere le icone   (B7) e (B8) finché la macchina visualizza il messaggio "DUREZZA ACQUA".

- Premere l'icona  (B9).
- Premere le icone   (B7) e (B8) fino a selezionare il numero corrispondente a quanti sono i quadratini rossi che si sono formati sulla striscia reattiva (esempio, se sulla striscia reattiva si sono formati 3 quadratini rossi è necessario selezionare il messaggio "DUREZZA ACQUA 3");
- Premere l'icona  (B9) per confermare il dato. Ora la macchina è programmata per dare l'avviso di eseguire la decalcificazione quando è effettivamente necessaria.

Programmazione caffè

Per le istruzioni relative alla programmazione del caffè, fare riferimento al capitolo "MODIFICA DELLA QUANTITÀ DI CAFFÈ IN TAZZA".

Programmazione acqua

Per le istruzioni fare riferimento al capitolo "MODIFICA DELLA QUANTITÀ DI ACQUA CALDA".

Decalcificazione









 **Attenzione!** Il decalcificante contiene acidi. Osservare le avvertenze di sicurezza del produttore, riportate sul contenitore del decalcificante.

 **Nota Bene!** Utilizzare esclusivamente decalcificante raccomandato dal costruttore. In caso contrario la garanzia non è valida. Inoltre la garanzia non è valida se la decalcificazione non è regolarmente eseguita.

 **Attenzione!** Prima di eseguire la decalcificazione, assicurarsi che sia stato rimosso il filtro addolcitore.

Quando la macchina visualizza il messaggio "DE-CALCIFICARE" è arrivato il momento di eseguire la decalcificazione. Procedere come segue:

- Assicurarsi che la macchina sia pronta per l'uso.

- Premere l'icona  (B2) per entrare nel menù e poi premere le icone   (B7) e (B8) finché la macchina visualizza il messaggio "DECALCIFICAZIONE".
- Premere l'icona  (B9) e la macchina visualizza il messaggio "DECALCIFICAZIONE CONFERMARE".
- Premere l'icona  (B9). Sul display compare la scritta "INSERIRE DECALCIFIC. CONFERMARE".
- Svuotare il serbatoio dell'acqua, versare il contenuto del flacone di decalcificante rispettando le indicazioni riportate sulla confezione del decalcificante, quindi aggiungere acqua fino ad arrivare al livello MAX impresso sul serbatoio acqua. Posizionare un recipiente di circa 2 litri di capacità sotto l'erogatore acqua calda.
- Premere l'icona  (B9); la soluzione decalcificante esce dall'erogatore acqua calda e comincia a riempire il contenitore sottostante. La macchina visualizza il messaggio "DECALCIFICANDO".
- Il programma di decalcificazione esegue automaticamente una serie di erogazioni e di pause.
- Dopo circa 30 minuti, la macchina visualizza il messaggio "DECALCIFIC. COMPLETA CONFERMARE".
- Premere l'icona  (B9) e la macchina visualizza il messaggio "RISCIACQUO CONFERMARE".
- Svuotare il serbatoio dell'acqua, risciacquarlo per eliminare i residui di decalcificante e riempirlo con acqua pulita.
- Reinserrire il serbatoio pieno di acqua pulita. Sul display ricompare la scritta "RISCIACQUO CONFERMARE".
- Premere nuovamente l'icona  (B9). L'acqua calda esce dall'erogatore, riempie il contenitore e la macchina visualizza il messaggio "RISCIACQUO".
- Attendere il messaggio "RISCIACQUO COMPLETO CONFERMARE".
- Premere l'icona  (B9). Sul display compare la scritta "DECALCIFICAZIONE COMPLETA" e poi "RIEMPIRE SERBATOIO".

Riempire nuovamente il serbatoio con acqua pulita.

- Il programma di decalcificazione è ora terminato e la macchina è pronta per fare nuovamente il caffè.





NOTA: Se si interrompe la procedura di decalcificazione prima che sia completata, è necessario ricominciare tutto da capo.



Attenzione! LA GARANZIA NON È VALIDA, SE LA DECALCIFICAZIONE NON È REGOLARMENTE ESEGUITA.







Ritorno alle impostazioni di fabbrica (reset)

È possibile ritornare alle impostazioni originali della macchina (anche dopo che l'utente le ha modificate) procedendo nel seguente modo:

- Premere l'icona  (B2) per entrare nel menù e poi premere le icone   (B7) e (B8) finché la macchina visualizza il messaggio "VALORI FABBRICA".
- Premere l'icona  (B9) e la macchina visualizza il messaggio "VALORI FABBRICA CONFERMARE".
- premere l'icona  (B9) per ritornare alle impostazioni di fabbrica;

Statistica

Con questa funzione si visualizzano i dati statistici della macchina. Per visualizzarli, procedere come segue:

- Premere l'icona  (B2) per entrare nel menù e poi premere le icone   (B7) e (B8) finché la macchina visualizza il messaggio "STATISTICA".
- Premere l'icona  (B9).
- Premendo le icone   (B7) e (B8) è possibile verificare:
 - Quanti caffè sono stati erogati.
 - Quante decalcificazioni sono state effettuate.
 - Quanti litri d'acqua sono stati complessivamente erogati.
- Premere una volta l'icona  (B6) per uscire da questa funzione, oppure premere due volte l'icona  (B6) per uscire dal

menù.

Avviso acustico

Con questa funzione si attiva o disattiva l'avviso acustico che la macchina emette ad ogni pressione delle icone e ad ogni inserimento/rimozione degli accessori.



Nota Bene! La macchina è preimpostata con l'avviso acustico attivato.

- Premere l'icona (B2) per entrare nel menù e poi premere le icone (B7) e (B8) finché la macchina visualizza il messaggio "AVVISO ACUSTICO".
- Premere l'icona (B9). Sul display compare la scritta "AVVISO ACUSTICO CONFERMARE".
- Premere l'icona (B6) per disattivare l'avviso acustico, oppure premere l'icona (B9) per attivarlo.
- Premere l'icona (B6) per uscire dal menù.

Regolazione contrasto

Se si desidera aumentare o diminuire il contrasto del display, procedere come segue:

- Premere l'icona (B2) per entrare nel menù e poi premere le icone (B7) e (B8) finché la macchina visualizza il messaggio "CONTRASTO".
- Premere l'icona (B9).
- Premere le icone (B7) e (B8) finché il contrasto desiderato è visualizzato sul display: la barra progressiva indica il livello di contrasto selezionato.
- Premere l'icona (B9) per confermare.
- Premere una volta l'icona (B6) per uscire da questa funzione, oppure premere due volte l'icona (B6) per uscire dal menù.

Filtro acqua

Per le istruzioni relative al filtro addolcitore, fare riferimento al capitolo "INSTALLAZIONE DEL FILTRO".

SPEGNIMENTO DELL'APPARECCHIO

Ogni volta che si spegne l'apparecchio, viene eseguito un risciacquo automatico, che non può essere interrotto.



Pericolo scottature! Durante il risciacquo, dai beccucci dell'erogatore del caffè fuoriesce un po' di acqua calda. Prestare attenzione di non venire in contatto con spruzzi d'acqua.

Per spegnere l'apparecchio, premere il tasto accensione/stand-by (A7). L'apparecchio esegue il risciacquo e poi si spegne.



Nota Bene! Se l'apparecchio non viene utilizzato per periodi prolungati, premere anche l'interruttore generale ON/OFF (A23), posto sul retro dell'apparecchio, in posizione 0.

DATI TECNICI

Tensione: 220-240 V~ 50/60 Hz max. 10A

Potenza assorbita: 1350W

Pressione: 15 bar

Capacità serbatoio acqua: 1,8 litri

Dimensioni LxHxP: 594 x 455 x 398 mm

Peso: 23/24 kg





L'apparecchio è conforme alle seguenti direttive CE:

- Direttiva Bassa Tensione 2006/95/CE e successivi emendamenti.
- Direttiva EMC 2004/108/CE e successivi emendamenti.
- **Regolamento Europeo Stand-by 1275/2008**

I materiali e gli oggetti destinati al contatto con prodotti alimentari sono conformi alle prescrizioni del regolamento Europeo (CE) N°1935/2004.

MESSAGGI VISUALIZZATI SUL DISPLAY

MESSAGGIO VISUALIZZATO	POSSIBILE CAUSA	RIMEDIO
RIEMPIRE IL SERBATOIO	<ul style="list-style-type: none"> Il serbatoio dell'acqua è vuoto oppure è male inserito. 	<ul style="list-style-type: none"> Riempire il serbatoio dell'acqua e/o inserirlo correttamente, premendolo a fondo.
MACINATO TROPPO FINE REGOLARE MACININO <i>(alternato)</i> PREMERE OK	<ul style="list-style-type: none"> La macinatura è troppo fine e quindi il caffè fuoriesce troppo lentamente. La macchina non riesce a fare il caffè perchè c'è dell'aria nel circuito idraulico. Possibile causa: la procedura di installazione del filtro non è stata eseguita correttamente. 	<ul style="list-style-type: none"> Ruotare la manopola di regolazione macinatura di uno scatto verso il numero 7. Controllare che il filtro (A25) sia installato bene e che la procedura di installazione sia stata eseguita correttamente.
MACINATO TROPPO FINE REGOLARE MACININO <i>(alternato)</i> PREMERE OK <i>(e successivamente)</i> RIEMPIRE SERBATOIO	<ul style="list-style-type: none"> Il serbatoio è stato disinserito durante l'erogazione. 	<ul style="list-style-type: none"> Inserire il serbatoio e premere l'icona  (B9). Il display visualizza "ACQUA CALDA PREMERE OK". Premere ancora l'icona  (B9). La macchina ritorna in modalità di pronta all'uso.
SVUOTARE CONTENITORE FONDI CAFFÉ	<ul style="list-style-type: none"> Il contenitore dei fondi (A4) di caffè è pieno o sono trascorsi più di tre giorni dall'ultima erogazione (tale operazione garantisce una corretta igiene della macchina). 	<ul style="list-style-type: none"> Svuotare il contenitore dei fondi ed eseguire la pulizia, poi reinserirlo. Importante: quando si estrae la vaschetta raccogligocce è OBBLIGATORIO svuotare sempre il contenitore fondi caffè anche se è riempito poco. Se questa operazione non è effettuata può succedere che, quando si fanno i caffè successivi, il contenitore fondi si riempia più del previsto e che la macchina si intasi.
INSERIRE CONTENITORE FONDI	<ul style="list-style-type: none"> Dopo la pulizia non è stato inserito il contenitore dei fondi. 	<ul style="list-style-type: none"> Aprire lo sportello di servizio e inserire il contenitore dei fondi.

MESSAGGIO VISUALIZZATO	POSSIBILE CAUSA	RIMEDIO
INSERIRE CAFFÈ PRE-MACINATO	<ul style="list-style-type: none"> • È stata selezionata la funzione “caffè pre-macinato”, ma non è stato versato il caffè pre-macinato nell’imbuto. • L’imbuto (A21) è ostruito. 	<ul style="list-style-type: none"> • Estrarre la macchina ed introdurre il caffè pre-macinato nell’imbuto”. • Svuotare l’imbuto con l’aiuto di un coltello come descritto nel paragrafo “pulizia dell’imbuto per l’introduzione del caffè pre-macinato”.
DECALCIFICARE!	<ul style="list-style-type: none"> • Indica che è necessario decalcificare la macchina. 	<ul style="list-style-type: none"> • E' necessario eseguire al più presto il programma di decalcificazione descritto nel cap. “Decalcificazione”.
RIDURRE DOSE CAFFÈ	<ul style="list-style-type: none"> • È stato utilizzato troppo caffè. 	<ul style="list-style-type: none"> • Selezionare un gusto più leggero oppure ridurre la quantità di caffè pre-macinato e poi richiedere nuovamente l'erogazione di caffè.
RIEMPIRE CONTENITORE CHICCHI CAFFÈ	<ul style="list-style-type: none"> • I chicchi di caffè sono finiti. 	<ul style="list-style-type: none"> • Riempire il contenitore chicchi.
INSERIRE GRUPPO INFUSORE	<ul style="list-style-type: none"> • Dopo la pulizia non è stato reinserito l’infusore. 	<ul style="list-style-type: none"> • Inserire l’infusore come descritto nel cap. “Pulizia dell’infusore”.
CHIUDERE SPORTELLLO	<ul style="list-style-type: none"> • Lo sportello di servizio è aperto. 	<ul style="list-style-type: none"> • Chiudere lo sportello di servizio.
ALLARME GENERICO!	<ul style="list-style-type: none"> • L’interno della macchina è molto sporco. 	<ul style="list-style-type: none"> • Pulire accuratamente la macchina come descritto nel par. “pulizia e manutenzione”. Se dopo la pulizia, la macchina visualizza ancora il messaggio, rivolgersi ad un centro di assistenza.
SOSTITUIRE FILTRO!	<ul style="list-style-type: none"> • Indica che è necessario sostituire il filtro addolcitore (A25). 	<ul style="list-style-type: none"> • È necessario sostituire subito il filtro seguendo le istruzioni nel paragrafo “Sostituzione del filtro”.

RISOLUZIONE DEI PROBLEMI

In basso sono elencati alcuni possibili malfunzionamenti.

Se il problema non può essere risolto nel modo descritto, si deve contattare l'Assistenza Tecnica.

PROBLEMA	POSSIBILE CAUSA	RIMEDIO
Il caffè non è caldo.	<ul style="list-style-type: none"> Le tazze non sono state pre-riscaldate. L'infusore si è raffreddato perché sono trascorsi 2/3 minuti dall'ultimo caffè. La temperatura impostata non è sufficiente. 	<ul style="list-style-type: none"> Riscaldare le tazze risciacquandole con dell'acqua calda. Prima di fare il caffè riscaldare l'infusore selezionando la funzione RISCIAQUO all'interno del menù. Modificare la temperatura impostata (vedi paragrafo "Modifica della temperatura del caffè").
Il caffè ha poca crema.	<ul style="list-style-type: none"> Il caffè è macinato troppo grosso. La miscela del caffè non è adatta. 	<ul style="list-style-type: none"> Ruotare la manopola di regolazione macinatura di uno scatto verso il numero 1 in senso antiorario mentre il macinacaffè è in funzione (fig. 11). Utilizzare una miscela di caffè per macchine da caffè espresso.
Il caffè fuoriesce troppo lentamente oppure a gocce.	<ul style="list-style-type: none"> Il caffè è macinato troppo fine. 	<ul style="list-style-type: none"> Ruotare la manopola di regolazione macinatura di uno scatto verso il numero 7 in senso orario, mentre il macinacaffè è in funzione (fig. 11). Procedere uno scatto alla volta fino ad ottenere un'erogazione soddisfacente. L'effetto è visibile solo dopo l'erogazione di 2 caffè.

PROBLEMA	POSSIBILE CAUSA	RIMEDIO
Il caffè fuoriesce troppo velocemente.	<ul style="list-style-type: none"> • Il caffè è macinato troppo grosso. 	<ul style="list-style-type: none"> • Ruotare la manopola di regolazione macinatura di uno scatto verso il numero 1 in senso antiorario mentre il macinacaffè è in funzione (fig. 11). Attenzione a non ruotare troppo la manopola di regolazione macinatura altrimenti, quando si richiedono due caffè, l'erogazione può avvenire a gocce. L'effetto è visibile solo dopo l'erogazione di 2 caffè.
Il caffè non esce da uno oppure entrambi i beccucci dell'erogatore.	<ul style="list-style-type: none"> • I beccucci sono otturati. 	<ul style="list-style-type: none"> • Pulire i beccucci con uno stuzzicadenti (fig. 23).
Il caffè non esce dai beccucci dell'erogatore, ma lungo lo sportello di servizio (A2).	<ul style="list-style-type: none"> • I fori dei beccucci sono otturati da polvere di caffè secca. • Il convogliatore caffè (A3) all'interno dello sportello di servizio si è bloccato. 	<ul style="list-style-type: none"> • Pulire i beccucci con uno stuzzicadenti, una spugna o uno spazzolino da cucina con setole dure (fig. 23). • Pulire accuratamente il convogliatore caffè (A3) , soprattutto in prossimità delle cerniere.
Dall'erogatore non fuoriesce caffè ma acqua.	<ul style="list-style-type: none"> • Il caffè macinato è rimasto bloccato nell'imbuto (A21) 	<ul style="list-style-type: none"> • Pulire l'imbuto (A21) con una forchetta di legno o plastica, pulire l'interno della macchina.

INHOUDSOPGAVE

INLEIDING7

- In deze aanwijzingen gebruikte symbolen7
- Letters tussen haakjes.....7
- Problemen en reparaties7

VEILIGHEID7

- Belangrijke waarschuwingen voor de veiligheid7
- Gebruik conform de bestemming8
- Gebruiksaanwijzingen.....8

BESCHRIJVING VAN HET APPARAAT.8

- Beschrijving van het apparaat8
- Beschrijving van het bedieningspaneel.....8

VOORBEREIDENDE

WERKZAAMHEDEN9

- Controle van het transport.....9
- Installatie van het apparaat.....9
- Aansluiting van het apparaat9

VERWERKING.....9

INSTALLATIE (INBOUW)10

EERSTE GEBRUIK VAN HET

APPARAAT12

- Installatie van het filter12
- Vervanging van het filter13
- Verwijdering van het filter13

INSCHAKELING EN OPWARMING ...13

KOFFIE ZETTEN (MET KOFFIEBONEN) 14

DE HOEVEELHEID KOFFIE IN HET

KOPJE WIJZIGEN15

DE MAALGRAAD REGELEN15

ESPRESSOKOFFIE ZETTEN MET VOORGEMALEN KOFFIE (IN PLAATS VAN KOFFIEBONEN)16

AFGIFTE VAN HEET WATER16

DE HOEVEELHEID HEET WATER WIJZIGEN16

CAPPUCCINO BEREIDEN (MET DE STOOMFUNCTIE)17

REINIGING17

- Reiniging van het apparaat.....17
- Reiniging van het koffiedikreservoir18
- Reiniging van het drupbakje18
- Reiniging van de watertank18
- Reiniging van de spuitmonden18
- Reiniging van de trechter voor het inbrengen van de voorgemalen koffie.....18
- Reiniging van de binnenkant van het apparaat.....18
- Reiniging van de koffiezeteenheid18

DE MENUPARAMETERS WIJZIGEN EN INSTELLEN19

- Instelling van de taal19
- Spoelen20
- Wijziging van de uitschakeltijd20
- Instelling van de klok.....20
- Instelling van het tijdstip van automatische inschakeling20
- Wijziging van de koffietemperatuur21
- Programmering van de hardheid van het water21
- Programmering koffie21
- Programmering water21
- Ontkalking21
- Herstellen van de fabrieksinstellingen (reset)22
- Statistiek-modus22
- Zoemer23
- Contrastregeling.....23
- Waterfilter23

UITSCHAKELING VAN HET APPARAAT 23

TECHNISCHE GEGEVENS23

MELDINGEN OP HET DISPLAY24

OPLOSSING VAN PROBLEMEN26

INLEIDING

In deze aanwijzingen gebruikte symbolen

De belangrijke waarschuwingen gaan van deze symbolen vergezeld. Veronachtzaming van de vermelde aanwijzingen kan elektrische schokken, ernstig letsel, brandwonden, brand of schade aan het apparaat veroorzaken.



Gevaar!

Veronachtzaming kan de oorzaak zijn of is de oorzaak van letsels door elektrische schokken met gevaar voor het leven.



Attentie!

Veronachtzaming kan de oorzaak zijn of is de oorzaak van letsel of schade aan het apparaat.



Gevaar brandwonden!

Veronachtzaming kan de oorzaak zijn of is de oorzaak van brandwonden of verbrandingen.



Nota Bene:

Belangrijke informatie voor de gebruiker.

Letters tussen haakjes

De letters tussen haakjes komen overeen met de legenda in de Beschrijving van het apparaat (pag. 3).

Problemen en reparaties

Volg, in geval van problemen, de aanwijzingen op in de paragrafen "Meldingen op het display" en "Oplossing van problemen". Als deze ondoeltreffend mochten blijken, wordt geadviseerd om de klantenservice te raadplegen. Wendt u zich voor reparaties uitsluitend tot de Technische Service.

VEILIGHEID

Belangrijke waarschuwingen betreffende de veiligheid



Attentie! Dit apparaat is uitsluitend bestemd voor huishoudelijke doeleinden. Gebruik in de volgende ruimten/situaties is niet voorzien:

- ruimten ingericht als keuken voor het personeel van winkels, kantoren en andere werzones
- vakantieboerderijen
- hotels, motels en andere logiesgelegenheden
- kamerverhuurders



Gevaar! Aangezien het apparaat met elektrische stroom werkt, dient men zich aan de volgende veiligheidsvoorschriften te houden:

- Raak het apparaat nooit met vochtige of natte handen aan.
- Raak de stekker nooit met vochtige of natte handen aan.
- Controleer of het gebruikte stopcontact altijd vrij toegankelijk is, want alleen op die manier kan de stekker indien nodig meteen verwijderd worden.
- Trek nooit aan het snoer om schade te voorkomen. Pak de stekker vast en trek hem uit het stopcontact.
- Zet de hoofdschakelaar (A23) aan de zijkant in de stand 0 om het apparaat volledig uit te schakelen.
- Probeer de defecten van het apparaat niet eigenhandig te repareren. Schakel het apparaat uit met de hoofdschakelaar (A23), verwijder de stekker uit het stopcontact en wendt u zich tot de Technische Service.
- Laat een beschadigde stekker of snoer uitsluitend vervangen door de Technische Service om gevaar te voorkomen.



Attentie! Bewaar het verpakkingsmateriaal (plastic zakjes, piepschuim, e.d.) buiten het bereik van kinderen.



Attentie! Sta het gebruik van dit apparaat niet toe aan personen (ook kinderen) met beperkte mentale, fysieke of sensorische capaciteiten, of met onvoldoende ervaring of kennis, tenzij ze aandachtig worden gevolgd of geïnstrueerd door iemand die verantwoordelijk is voor hun veiligheid. Houd toezicht op kinderen en zorg ervoor dat ze niet met het apparaat spelen.



Gevaar brandwonden! Dit apparaat produceert heet water en wanneer het werkt kan er

waterdamp gevormd worden. Let op dat u niet in contact komt met waterspatten of hete stoom. Gebruik de knoppen of handgrepen.



Attentie! Steunt u niet op het apparaat wanneer het uit het meubel is getrokken. Plaats geen voorwerpen op het apparaat die vloeistoffen, ontvlambare of corrosieve materialen bevatten, gebruik het accessoirevak voor het opbergen van de accessoires die nodig zijn voor het zetten van koffie (bijvoorbeeld het maatschepje). Plaats geen grote voorwerpen die bewegingen kunnen verhinderen of instabiele voorwerpen op het apparaat.



Attentie! Gebruik het huishoudelijke apparaat niet wanneer het uit zijn nis is getrokken: wacht altijd tot het apparaat inactief is alvorens het uit te trekken. Het regelen van de maalgraad vormt hierop een uitzondering, wat namelijk bij uitgetrokken apparaat moet gebeuren (zie hoofdstuk "De maalgraad regelen").



Nota Bene: Gebruik uitsluitend originele of door de fabrikant aanbevolen accessoires en reserveonderdelen.

Gebruik conform de bestemming

Dit apparaat is gemaakt voor het zetten van koffie en het verwarmen van drankjes. Elk ander gebruik moet als oneigenlijk beschouwd worden. Dit apparaat is niet geschikt voor commercieel gebruik. De fabrikant aanvaardt geen aansprakelijkheid voor schade veroorzaakt door oneigenlijk gebruik van het apparaat. Dit apparaat kan geïnstalleerd worden boven een inbouw magnetron, als deze aan de bovenkant voorzien is van een koelventilator (maximumvermogen van de magnetron 3 kW).

Gebruiksaanwijzingen

Lees deze aanwijzingen aandachtig door alvorens het apparaat te gebruiken.

- Bewaar deze aanwijzingen zorgvuldig.
- Veronachtzaming van deze aanwijzingen kan leiden tot letsel aan personen en schade aan het apparaat. De fabrikant aanvaardt geen aansprakelijkheid voor schade veroorzaakt door veronachtzaming van deze gebruiksaanwijzingen.



Nota Bene: Het apparaat is voorzien van een koelventilator. Deze treedt in werking wanneer koffie, stoom of heet water wordt afgegeven. Na enkele minuten gaat de ventilator automatisch uit.

BESCHRIJVING VAN HET APPARAAT

Beschrijving van het apparaat

(pag. 3 - A)

- A1. Opzetvlak kopjes
- A2. Servicedeurtje
- A3. Koffietoevoerlaatje
- A4. Koffiedikreservoir
- A5. Koffiezeteenheid
- A6. Verlichting opzetvlak kopjes
- A7. Inschakel-/standbyknop
- A8. Bedieningspaneel
- A9. IEC connector
- A10. Uitneembaar cappuccinomondstuk
- A11. Spuitmond cappuccinomondstuk
- A12. Watertank
- A13. Afgiftegroep koffie (verstelbaar in de hoogte)
- A14. Drupbakje
- A15. Deksel van koffiebonenreservoir
- A16. Koffiebonenreservoir
- A17. Regelknop maalgraad
- A18. Klepje van trechter voor gemalen koffie
- A19. Maatschepje
- A20. Opbergruimte maatschepje
- A21. Trechter voor inbrengen voorgemalen koffie
- A22. Netsnoer
- A23. ON/OFF hoofdschakelaar
- A24. Accessoirevak
- A25. Waterfilter (op sommige modellen)

Beschrijving van het bedieningspaneel

(pag. 3 - B)



Nota Bene: Wanneer een functie wordt gebruikt, worden op het bedieningspaneel alleen die pictogrammen verlicht waarvan de commando's beschikbaar zijn.



Nota Bene: Om de pictogrammen te activeren, is een lichte aanraking voldoende.

- B1. Display: helpt de gebruiker bij het gebruik van het apparaat.
- B2. Pictogram  voor het activeren of inactiveren van de instelmodus van de menuparameters
- B3. Pictogram  voor het in-/uitschakelen van de verlichting A6
- B4. Pictogram  voor de selectie van de smaak van de koffie
- B5. Pictogram  voor de selectie van de gewenste soort koffie (espressokopje, klein kopje, kopje medium, grote kop, beker)
- B6. Pictogram  om de geselecteerde modus af te sluiten
- B7-B8. Pictogrammen   om het menu in beide richtingen te doorlopen en de verschillende werkwijzen weer te geven.
- B9. Pictogram  om de geselecteerde functie te bevestigen
- B10. Pictogram  voor de afgifte van een kop koffie
- B11. Pictogram  voor de afgifte van twee koppen koffie
- B12. Pictogram  voor de afgifte van stoom
- B13. Pictogram  voor de afgifte van heet water.

VOORBEREIDENDE WERKZAAMHEDEN

Controle van het transport

Controleer, na de verpakking te hebben verwijderd, of het apparaat intact is en alle accessoires aanwezig zijn. Gebruik het apparaat niet indien schade wordt geconstateerd. Wendt u zich tot de Technische Service.

Installatie van het apparaat



Attentie!

- De installatie moet verricht worden door een vakkundig technicus overeenkomstig de geldende plaatselijke voorschriften (zie par. "Installatie (inbouw)").

- De verpakkingselementen (plastic zakken, polyester, e.d.) moeten buiten het bereik van kinderen gehouden worden.
- Installeer het huishoudelijke apparaat nooit in vertrekken waar de temperatuur tot 0° C kan zakken.
- Pas zo snel mogelijk de waarden van de hardheid van het water aan volgens de aanwijzingen in "Programmering van de hardheid van het water".

Aansluiting van het apparaat



Gevaar! Controleer of de netspanning overeenkomt met de spanning aangeduid op het gegevensplaatje aan de onderkant van het apparaat. Sluit het apparaat alleen aan op een volgens de regels geïnstalleerd stopcontact met een minimaal vermogen van 10A en voorzien van een doeltreffende aarding. Indien de stekker niet in het stopcontact past, het stopcontact door een vakman laten vervangen door een stopcontact van het geschikte type. Voor het in acht nemen van de veiligheidsrichtlijnen, moet tijdens de installatie een meerpoleige schakelaar met een minimumafstand tussen de contacten van 3 mm worden gebruikt. Gebruik geen meervoudige contactdozen of verlengsnoeren.



Attentie! Er moeten uitschakelvoorzieningen in het stroomnet aanwezig zijn die voldoen aan de nationale installatievoorschriften.

VERWERKING



Krachtens de Europese richtlijn 2002/96/EG mag het apparaat niet samen met het huishoudelijke afval worden verwerkt, maar moet het naar een officieel inzamelcentrum gebracht worden.

INSTALLATIE (INBOUW)

Controleer de benodigde minimumafmetingen voor de correcte installatie van het apparaat. Het koffiezetapparaat moet geïnstalleerd worden in een kolom en deze kolom moet stevig aan de muur bevestigd zijn m.b.v. beugels die in de handel verkrijgbaar zijn.

Attentie:

- Belangrijk: Alle installatie- en onderhoudswerkzaamheden moeten verricht worden terwijl het apparaat van het elektriciteitsnet is afgekoppeld.
- De keukenmeubels die rechtstreeks contact maken met het apparaat moeten hittebestendig zijn (min. 65°C).
- Laat, om een correcte ventilatie te garanderen, een opening aan de onderkant van het meubel vrij (zie afmetingen op afbeelding).

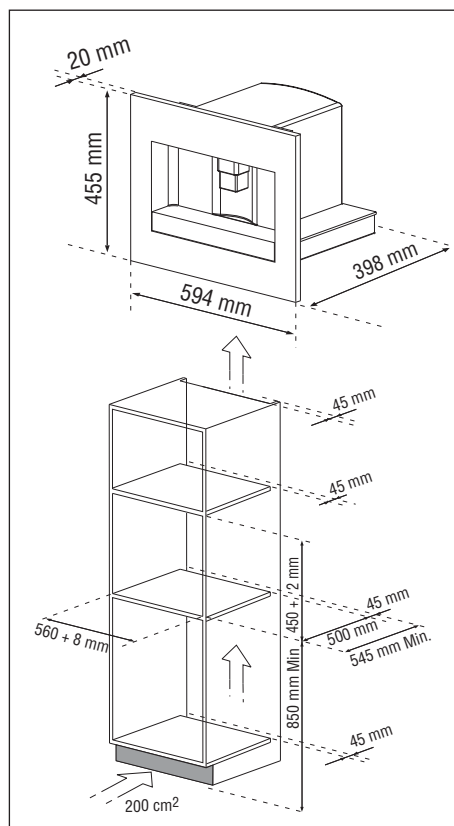
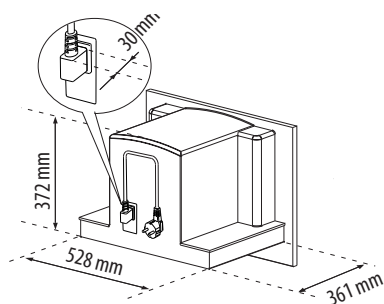

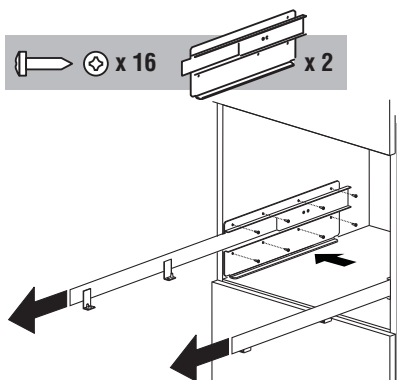

Plaats de rails op de zijoppervlakken van het meubel, zoals getoond in de figuur. Bevestig de rails met hun schroeven en trek ze vervolgens volledig uit. Indien het koffiezetapparaat boven een “warmhoudlade” geïnstalleerd wordt, gebruik dan het bovenste oppervlak van deze warmhoudlade als referentie voor het plaatsen van de rails. In dat geval zal er geen opzetvlak zijn.

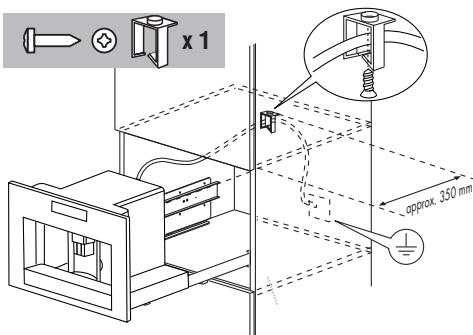

Bevestig het netsnoer met de hiervoor bestemde clip.

Het netsnoer moet lang genoeg zijn om toe te staan dat het apparaat uit het meubel kan worden geschoven wanneer het koffiebonenreservoir gevuld moet worden.

De aarding van het apparaat is wettelijk verplicht.

De elektrische aansluiting moet door een gekwalificeerd technicus overeenkomstig de aanwijzingen uitgevoerd worden.

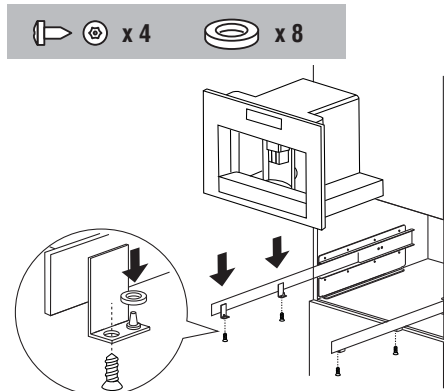



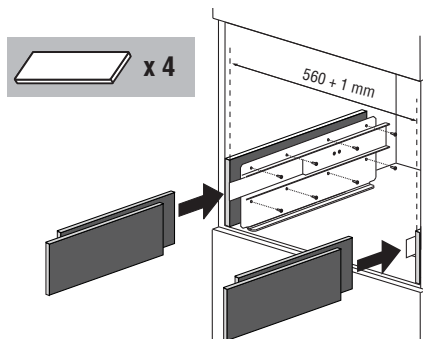

Plaats het apparaat op de rails en controleer of de pennen goed in hun zittingen zijn ingebracht, en bevestig daarna het apparaat met de bijgevoegde schroeven. Gebruik voor de aanpassing van de hoogte van het apparaat de bijgevoegde cirkelvormige afstandsstukken.



Als het apparaat niet perfect waterpas mocht staan, kunnen de bijgevoegde afstandsstukken onder of opzij van de steun worden geplaatst.

EERSTE GEBRUIK VAN HET APPARAAT

- Op de fabriek is er koffie gebruikt tijdens de controle van de machine; het is dus normaal als u sporen van koffie in de koffiemolen aantreft.
 - Pas zo snel mogelijk de waarden van de hardheid van het water aan volgens de procedure “Programmering van de hardheid van het water”.
1. Sluit het apparaat op het elektriciteitsnet aan. Stel de gewenste taal in.
 2. Gebruik voor het instellen van de taal de pictogrammen   (B7 en B8) tot de gewenste taal wordt verkregen (fig. 2). Wanneer op het display de volgende melding verschijnt: “DRUK OK VOOR NEDERLANDS”, houd dan minstens 3 seconden het pictogram  (B9) (fig. 3) ingedrukt tot de melding “NEDERLANDS INGESTELD” verschijnt. Als een niet gewenste taal wordt geselecteerd, volg dan de aanwijzingen in hoofdstuk “Wijziging van de taal”. Als uw taal niet beschikbaar is, kiest u dan een andere taal die vermeld is op het display. In de aanwijzingen wordt de Engelse taal als uitgangspunt genomen. Volg hierna de aanwijzingen die op het display worden aangegeven:
 3. Na 5 seconden geeft het apparaat weer “VUL TANK”: verwijder de tank (fig. 4), spoel hem en vul hem met schoon water zonder de streep MAX te overschrijden. Plaats de tank terug en duw hem goed aan. In de tank kan een waterfilter geïnstalleerd worden (fig. 29).
 4. Plaats vervolgens een kopje onder het cappuccinomondstuk (fig. 5). Het apparaat toont “HEET WATER DRUK OK”. Druk op het pictogram  (B9) (fig. 3) en na enkele seconden loopt een beetje water uit het cappuccinomondstuk.
 5. Het apparaat toont “UITZETTEN WACHT AUB” en het apparaat gaat uit.
 6. Trek het apparaat naar buiten bij de hiervoor bestemde handgrepen (fig. 6): open het deksel en vul het koffiebonenreservoir, sluit het deksel en duw het apparaat weer naar

binnen.

Nu is het apparaat klaar voor het normale gebruik.



Attentie! Gebruik nooit voorgemalen koffie, oploskoffie, gekarameliseerde koffiebonen of andere voorwerpen die het apparaat kunnen beschadigen.



Nota Bene: Bij het eerste gebruik, is het noodzakelijk 4-5 kopjes koffie en 4-5 cappuccino's te zetten voordat een bevredigend resultaat wordt verkregen.



Nota Bene: Bij elke inschakeling m.b.v. de ON/OFF hoofdschakelaar (A23), zal het apparaat de functie “AUTO-DIAGNOSE” starten om vervolgens uit te schakelen; om het apparaat opnieuw in te schakelen, moet op de inschakel-/standbyknop (A7) gedrukt worden (fig. 1).

Installatie van het filter

Sommige modellen zijn van een waterfilter voorzien: dit verbetert de kwaliteit van het water en garandeert een langere levensduur van het apparaat. Ga als volgt te werk om het filter te installeren:

1. Verwijder het filter uit de verpakking;
2. Verplaats het schuifje van de datum aanduiding (zie fig. 29) tot de gebruiksmaanden worden weergegeven.



Nota Bene: het filter duurt twee maanden als het apparaat op normale wijze wordt gebruikt, als het apparaat echter niet gebruikt wordt terwijl het filter geïnstalleerd is, heeft het filter een duur van maximaal 3 weken.

3. Vul de tank met een beetje water tot het in de figuur aangegeven niveau wordt bereikt.



4. Doe het filter in de watertank en druk aan tot het de bodem van de tank raakt (zie figuur

- 29);
5. Vul de tank en breng hem in het apparaat aan;
 6. Plaats een kan onder het cappuccinomondstuk (inhoud: minimaal 100 ml).
 7. Druk op het pictogram  (B2) om het menu te openen;
 8. Druk op de pictogrammen   (B7) en (B8) totdat op het display het opschrift "INSTALLEER FILTER" verschijnt;
 9. Druk op het pictogram  (B9);
 10. Op het display verschijnt nu de melding: "INSTALLEER FILTER BEVESTIG AUB".
 11. Druk op het pictogram  (B9) om de selectie te bevestigen (of op  (B6) om te annuleren); het display toont "HEET WATER DRUK OK".
 12. Druk op het pictogram  (B9): op het display verschijnt het opschrift "WACHT AUB", terwijl het apparaat met de afgifte van heet water begint. Na afgifte geeft het apparaat automatisch weer de ingestelde basiswerkwijzen weer.

 **Nota Bene:** Het apparaat kan vragen om de handeling meerdere malen te herhalen, namelijk totdat alle lucht uit het hydraulische circuit is verwijderd.

Vervanging van het filter ("RESET FILTER")

Wanneer het display "VERVANG FILTER" toont, of wanneer twee maanden zijn verstreken (zie datumaanduiding), moet het filter vervangen worden:

1. Verwijder het uitgewerkte filter;
2. Verwijder het nieuwe filter uit de verpakking;
3. Verplaats het schuifje van de datumaanduiding (zie fig. 29) tot de gebruiksmaanden worden weergegeven (het filter heeft een duur van twee maanden);
4. Doe het filter in de watertank en druk aan tot het de bodem van de tank raakt (zie figuur 29);
5. Vul de tank en breng hem in het apparaat aan;
6. Draai het cappuccinomondstuk naar buiten en plaats er een kan onder (inhoud: minimaal

100 ml).

7. Druk op het pictogram  (B2) om het menu te openen;
8. Druk op de pictogrammen   (B7) en (B8) totdat op het display het opschrift "RESET FILTER" verschijnt;
9. Druk op het pictogram  (B9);
10. Op het display verschijnt nu de melding: "RESET FILTER BEVESTIG AUB".
11. Druk op het pictogram  (B9) om de selectie te bevestigen (of op  (B6) om te annuleren); het display toont "HEET WATER DRUK OK".
12. Druk op het pictogram  (B9): op het display verschijnt het opschrift "WACHT AUB", terwijl het apparaat met de afgifte van heet water begint. Na afgifte geeft het apparaat automatisch weer de ingestelde basiswerkwijzen weer.

Verwijdering van het filter

Om het apparaat zonder filter te gebruiken, moet het verwijderd worden en de verwijdering gemeld worden; ga hiervoor als volgt te werk:

1. Druk op het pictogram  (B2) om het menu te openen;
2. Druk op de pictogrammen   (B7) en (B8) totdat op het display het opschrift "INSTALLEER FILTER*" verschijnt;
3. Druk op het pictogram  (B9);
4. Op het display verschijnt nu de melding: "INSTALLEER FILTER BEVESTIG AUB";
5. Druk op het pictogram  (B6);
6. Druk, nadat de asterisk rechts boven op het display is verdwenen, op  (B6) om het menu af te sluiten.

 **Nota Bene!** Gebruik uitsluitend filters die door de fabrikant worden aanbevolen. Het gebruik van ongeschikte filters kan schade aan het apparaat veroorzaken.

INSCHAKELING EN OPWARMING

Elke keer dat het apparaat wordt ingeschakeld,

wordt automatisch een opwarmings- en spoelcyclus uitgevoerd die niet onderbroken kan worden. Het apparaat is alleen na uitvoering van deze cyclus klaar voor gebruik.



Gevaar brandwonden! Tijdens het spoelen loopt een beetje warm water uit de spuitmonden van de afgiftegroep van de koffie.

Druk, om het apparaat in te schakelen op de inschakel-/standbyknop (fig. 1): op het display verschijnt de melding “VERWARMEN WACHT AUB”. Na het opwarmen toont het apparaat een andere melding: “SPOELEN”; Het apparaat is op temperatuur wanneer op het display “KOPJE MEDIUM NORMAAL” verschijnt. Als na circa 2 minuten op geen enkel pictogram is gedrukt, verschijnt op het display de tijd (indien ingesteld) (zie paragraaf “Instelling van de klok”). Als de tijd niet is ingesteld, toont het apparaat de laatst ingestelde functies. Als op een willekeurig pictogram wordt gedrukt, verschijnt opnieuw “KOPJE MEDIUM NORMAAL”; het apparaat is opnieuw gereed om koffie te zetten.

KOFFIE ZETTEN (MET KOFFIEBONEN)

1. Het apparaat is in de fabriek ingesteld om koffie met een normaal aroma af te geven. Het is mogelijk koffie met extra mild, mild, sterk of extra sterk aroma te zetten, met de optie van voorgemalen koffie. Druk, om het gewenste aroma te selecteren, op het pictogram (B4) (fig. 7): het gewenste aroma verschijnt op het display.
2. Zet één kopje onder de afgiftegroep om 1 koffie te zetten (fig. 8) of 2 kopjes om 2 koffie te zetten (fig. 9). Om een smeuïger crème te verkrijgen, de afgiftegroep zo dicht mogelijk bij de kopjes brengen, door hem omlaag te zetten (fig. 10).
3. Druk op het pictogram (B5) (fig. 11) om het gewenste soort koffie te selecteren: espressokopje, klein kopje, kopje medium, grote kop, beker). Druk nu op het pictogram

(B10) (fig. 12) als u één koffie wilt zetten en op het pictogram (B11) (fig. 13) als u 2 koffie wilt zetten. Het apparaat maalt nu de koffiebonen en geeft de koffie af in het kopje. Zodra de vooraf ingestelde hoeveelheid koffie is verkregen, onderbreekt het apparaat de automatische afgifte en voert het koffiedik af naar het koffiedikreservoir.

4. Na enkele seconden is het apparaat opnieuw klaar voor gebruik.
5. Druk, om het apparaat uit te schakelen, op de inschakel-/standbyknop (A7) (fig. 1): (Vóór het uitschakelen, voert het apparaat automatisch een spoeling uit: let op dat u zich niet verbrandt).

OPMERKING 1: Als de koffie druppelsgewijs of helemaal niet afgegeven wordt, raadpleeg dan het hoofdstuk “Regeling van de maalgraad”.

OPMERKING 2: Als de koffie te snel afgegeven wordt en de crème niet bevredigend is, raadpleeg dan het hoofdstuk “Regeling van de maalgraad”.

OPMERKING 3: Tips om warmere koffie te verkrijgen:

- Ga te werk zoals beschreven in het hoofdstuk “De menuparameters wijzigen en instellen”, functie “Spoeling”.
- Gebruik geen te dikke kopjes, omdat deze te veel warmte aan de koffie onttrekken, tenzij ze voorverwarmd worden.
- Gebruik kopjes die zijn voorverwarmd door ze met warm water af te spoelen.

OPMERKING 4: Op elk moment kan de afgifte van koffie onderbroken worden door opnieuw op het eerder geselecteerde pictogram te drukken, dat verlicht blijft tijdens de werking.

OPMERKING 5: Als u, zodra de afgifte is beëindigd, de hoeveelheid koffie in de kop wilt verhogen, moet u het eerder geselecteerde pictogram binnen 3 seconden na afloop van de afgifte ingedrukt houden).

OPMERKING 6: wanneer op het display de volgende melding verschijnt: “VUL TANK” moet de watertank worden gevuld, want anders geeft het apparaat geen koffie af. (Het is normaal dat er nog wat water in het reservoir staat).

OPMERKING 7: na elke 14 enkele kopjes koffie (of 7 dubbele), toont het apparaat de melding:

“LEEG KOFFIEDIKRESERVOIR”. Het apparaat meldt 72 uur na de eerste afgifte dat het reservoir geleidigd moet worden, ook wanneer het niet vol is (met het oog op de correcte 72-uur aftelling mag de hoofdschakelaar nooit in de uitschakelstand 0 worden gezet). Open, voor de reiniging, het deurtje vooraan door aan de afgiftegroep te trekken (fig. 16), neem vervolgens het drupbakje uit (fig. 17) en maak het schoon.

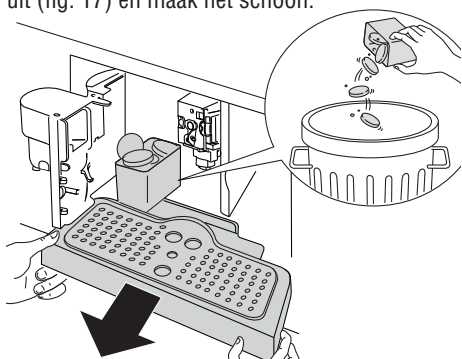

Wanneer gereinigd wordt, **moet het drupbakje altijd volledig verwijderd worden.**

⚠ Attentie! wanneer het drupbakje wordt verwijderd, moet het koffiedikreservoir **VERPLICHT** geleidigd worden. Als deze handeling niet wordt verricht, kan het apparaat verstopt raken.

OPMERKING 8: wanneer het apparaat koffie afgeeft, mag de watertank nooit verwijderd worden. *_Mocht dit toch gebeuren, dan slaagt het apparaat er niet meer in koffie te zetten en verschijnt de melding: “MAALT TE FIJN MAALGRAAD INSTELLEN EN DRUK OK” en vervolgens “VUL TANK”.* Controleer vervolgens het niveau van het water in de tank en breng de tank in. Druk, om het apparaat weer op te starten, op het pictogram  (B9) en het display toont “HEET WATER DRUK OK”. Druk binnen enkele seconden op het pictogram  (B9) en laat het water gedurende circa 30 seconden uit het cappuccinmondstuk weglopen. Na afgifte geeft het apparaat automatisch weer de ingestelde basiswerkwijzen weer.

i Nota Bene: Het apparaat kan vragen om

de handeling meerdere malen te herhalen, namelijk totdat alle lucht uit het hydraulische circuit is verwijderd.

i Nota Bene: Als de hierboven beschreven handeling niet correct wordt uitgevoerd of als het apparaat wordt uitgezet, kan het display weer de ingestelde basisfuncties weergeven, ook al is het probleem feitelijk nog aanwezig.

DE HOEVEELHEID KOFFIE IN HET KOPJE WIJZIGEN

Het apparaat is vooraf ingesteld in de fabriek om automatisch de volgende soorten koffie af te geven:

- espressokopje
- klein kopje
- kopje medium
- grote kop
- beker

Ga als volgt te werk om de hoeveelheid te wijzigen:

- Druk op het pictogram  (B2) om het menu te openen (fig. 15), druk op de pictogrammen   (B7) en (B8) (fig. 2) totdat de volgende melding verschijnt: “KOFFIEPROGRAMMA”.
- Druk op het pictogram  (B9).
- Selecteer het soort koffie dat gewijzigd moet worden m.b.v. de pictogrammen   (B7) en (B8).
- Druk op het pictogram  (B9) om het soort koffie dat gewijzigd moet worden te bevestigen.
- Gebruik de pictogrammen   (B7) en (B8) om de gewenste hoeveelheid koffie te wijzigen. De voortgangsbalk geeft de geselecteerde hoeveelheid koffie aan.
- Druk opnieuw op het pictogram  (B9) om te bevestigen (of op het pictogram  (B6) om te annuleren).
- Druk twee maal op het pictogram  (B6) (fig. 18) om het menu af te sluiten.

Nu is het apparaat volgens de nieuwe instellingen geprogrammeerd en klaar voor gebruik.

DE MAALGRAAD REGELEN

De koffiemolen hoeft niet te worden geregeld, omdat dit reeds in de fabriek is gebeurd; indien u evenwel na de eerste kopjes vaststelt dat de koffie te snel of te langzaam (druppelsgewijs) wordt afgegeven, moet de maalgraad worden geregeld met behulp van de regelknop van de maalgraad (fig. 14).

⚠️ Attentie! De regelknop van de maalgraad mag alleen verdraaid worden wanneer de koffiemolen in werking is.

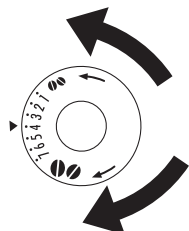

Om een langzamere koffieafgifte en een betere crème te verkrijgen, één klik linksom draaien (=koffiebonen fijner gemalen).

Om een snellere koffieafgifte te verkrijgen (niet druppelsgewijs), één klik rechtsom draaien (=koffiebonen grover gemalen).

KOFFIE ZETTEN MET VOORGEMALEN KOFFIE

- Druk op het pictogram  (B4) (fig. 7) en selecteer de functie voorgemalen koffie.
- Trek het apparaat naar buiten bij de hiervoor bestemde handgrepen.
- Til het dekseltje in het midden op, breng in de trechter een maatschepje voorgemalen koffie in (fig. 19); duw het apparaat naar binnen en ga te werk zoals beschreven in "Koffie zetten (met koffiebonen)."

NB: Er kan telkens 1 koffie gezet worden door te drukken op het pictogram  (B10) (fig. 12).

- Als men na het zetten van koffie met voorgemalen koffie, weer koffie wil zetten met koffiebonen, moet de functie voorgemalen koffie uitgeschakeld worden door nogmaals te drukken op het pictogram  (B4) (fig. 7).

OPMERKING 1: Doe nooit voorgemalen koffie in het apparaat wanneer dit uitgeschakeld is, om te

voorkomen dat de koffie verloren gaat in het apparaat.



OPMERKING 2: Breng nooit meer dan 1 maatschepje in, want anders zet het apparaat geen koffie.

OPMERKING 3: Gebruik uitsluitend het bijgevoegde maatschepje.

OPMERKING 4: Doe in de trechter uitsluitend voorgemalen koffie voor espressoapparaten.

OPMERKING 5: Indien meer dan één maatschepje voorgemalen koffie ingebracht wordt en de trechter verstopt raakt, gebruik dan een mes om de koffie te doen zakken (fig. 21), en verwijder en reinig vervolgens de zetgroep en het apparaat zoals beschreven in de paragraaf "Reiniging van de koffiezeteenheid".

AFGIFTE VAN HEET WATER

- Controleer altijd of het apparaat klaar is voor gebruik.
- Plaats het cappuccinomondstuk in het midden en plaats er een kan onder (fig. 5).
- Druk op het pictogram  (B13) (fig. 20). Het apparaat toont de melding "HEET WATER DRUK OK". Druk op het pictogram  (B9) en het hete water zal uit het cappuccinomondstuk in de kan lopen. (Laat niet langer dan 2 minuten achter elkaar heet water afgeven). Druk op het pictogram  (B13) of het pictogram  (B6) om te onderbreken. Het apparaat onderbreekt de afgifte zodra de vooraf ingestelde hoeveelheid is bereikt.

DE HOEVEELHEID HEET WATER WIJZIGEN

Het apparaat is in de fabriek ingesteld om automatisch 200 ml heet water af te geven. Indien u deze hoeveelheden wenst te wijzigen, als volgt te werk gaan:

- Plaats een kan onder het cappuccinomondstuk (fig. 5).
- Druk op het pictogram  (B2) om het menu te openen (fig. 15), druk op de pictogrammen  (B7) en  (B8) (fig. 2)





totdat de volgende melding verschijnt: “HETWATER PROGRAMMA”.

- Druk op het pictogram  (B9) om te bevestigen.
- Selecteer de gewenste hoeveelheid water m.b.v. de pictogrammen   (B7) en (B8). De voortgangsbalk geeft de geselecteerde hoeveelheid water aan.
- Druk op het pictogram  (B9) om te bevestigen (of op het pictogram  (B6) om te annuleren).
- Druk twee maal op het pictogram  (B6) (fig. 18) om het menu af te sluiten.
- Nu is het apparaat volgens de nieuwe instellingen geprogrammeerd en klaar voor gebruik.

CAPPUCCINO BEREIDEN (MET DE STOOMFUNCTIE)

- Draai het cappuccinmondstuk naar het midden (fig. 5).
- Neem een kan en vul hem met circa 100 gram melk voor elke cappuccino die u wilt bereiden en plaats hem onder het cappuccinmondstuk. Houd bij de keuze van de grootte van de kan er rekening mee dat het melkvolume kan verdubbelen of verdriedubbelen. Men raadt het gebruik van magere of halfvolle melk op koelkasttemperatuur aan.
- Druk op het pictogram  (B12) (fig. 22). Het display toont “STOOM DRUK OK”.
- Druk op het pictogram  (B9).
- Druk opnieuw op het pictogram  (B12) of het pictogram  (B6) om de stoomafgifte te onderbreken.
- Dompel het cappuccinmondstuk onder in het kannetje met melk (fig. 23) en let hierbij op dat het niet voor meer dan de helft van zijn lengte ondergedompeld wordt. Druk op het pictogram  (B12) (let op u niet te verbranden) en druk op het pictogram  (B9). De stoom komt uit het cappuccinmondstuk. Om een romiger schuim te verkrijgen, dompelt u het cappuccinmondstuk onder in de melk en beweegt u het kannetje met langzame op- en neergaande bewegingen. (Laat niet langer dan 2 minuten

achter elkaar stoom afgeven).

- Druk, zodra het gewenste schuim is verkregen, opnieuw op het pictogram  (B12) of het pictogram  (B6) om de stoomafgifte te onderbreken.
- Zet de koffie zoals hierboven beschreven, door voldoende grote koppen te gebruiken die vervolgens met de eerder bereide opgeschuimde melk worden gevuld. **BELANGRIJK:** reinig het cappuccinosysteem altijd onmiddellijk na het gebruik. Ga hiervoor als volgt te werk:
- Druk op het pictogram  (B12) en vervolgens op het pictogram  (B9) om gedurende enkele seconden een kleine hoeveelheid stoom af te geven. Dit zal het cappuccinmondstuk van eventuele melkresten ontdoen.

BELANGRIJK: om de hygiëne te waarborgen, wordt aanbevolen om deze procedure elke keer dat een cappuccino wordt gezet te volgen, om ophoping van melk in het circuit te voorkomen.

- Wacht tot het cappuccinmondstuk is afgekoeld, houd met één hand de hendel van het cappuccinmondstuk vast en draai met de andere hand het cappuccinmondstuk los door het linksom te draaien en naar beneden toe weg te trekken (fig. 24).
- Verwijder de spuitmond van het cappuccinmondstuk door hem naar beneden toe weg te trekken.
- Was het cappuccinmondstuk en de spuitmond zorgvuldig met warm water.
- Controleer of de twee gaatjes aangegeven in figuur 25 niet verstopt zijn. Reinig ze indien nodig met behulp van een naald.
- Breng de spuitmond weer aan door hem naar boven toe in het cappuccinmondstuk te steken.
- Plaats het cappuccinmondstuk door het omhoog te duwen en rechtsom te draaien.

REINIGING

Reiniging van het apparaat

Gebruik voor de reiniging van het apparaat geen oplosmiddelen of schurende reinigingsmiddelen. Het is voldoende om een vochtige en zachte doek te gebruiken. Geen enkel onderdeel van het ap-

paraat mag in de vaatwasser afgewassen worden. De volgende onderdelen van het apparaat moeten periodiek gereinigd worden:

- Koffiedikreservoir (A4).
- Drupbakje (A14).
- Watertank (A12).
- Spuitmonden van de afgiftegroep koffie (A13), de spuitmond heet water (A11) en het cappuccinomondstuk (A10).
- Trechter voor inbrengen van voorgemalen koffie (A21).
- Binnenkant van het apparaat, alleen toegankelijk nadat het deurtje is geopend (A2).
- Koffiezeteenheid (A5).

Reiniging van het koffiedikreservoir

Wanneer op het display het opschrift "LEEG KOFFIEDIKRESERVOIR" verschijnt, moet dit geleegd en gereinigd worden. Om de reiniging uit te voeren:

- open het deurtje vooraan (fig. 16), neem vervolgens het drupbakje uit (fig. 17) en maak het schoon.
- Reinig zorgvuldig het koffiedikreservoir.

 **Attentie!** wanneer het drupbakje wordt verwijderd, moet het koffiedikreservoir **verplicht** geleegd worden.

Reiniging van het drupbakje

 **Attentie!** Als het drupbakje niet geleegd wordt, kan het water overlopen. Dit kan het apparaat beschadigen.

Het drupbakje is voorzien van een drijvende indicator (rood) van het waterniveau in het bakje zelf (fig. 27). Voordat deze indicator uit het opzetvlak voor de kopjes steekt, moet het bakje geleegd en gereinigd worden. Om het bakje te verwijderen:

1. Open het servicedeurtje (fig. 16).
2. Verwijder het drupbakje en het koffiedikreservoir (fig. 17).
3. Reinig het drupbakje en het koffiedikreservoir (A4).
4. Breng het drupbakje met het koffiedikreservoir (A4) in.
5. Sluit het servicedeurtje.

Reiniging van de watertank

1. Reinig periodiek (circa eens per maand) de watertank (A12) met een vochtige doek en een beetje mild reinigingsmiddel.
2. Verwijder zorgvuldig eventuele resten reinigingsmiddel.

Reiniging van de spuitmonden

1. Reinig de spuitmonden regelmatig met een sponsje (fig. 28).
2. Controleer periodiek of de gaatjes van de koffieafgiftegroep niet verstopt zijn. Verwijder indien nodig de aangekoekte koffieresten met een tandenstoker (fig. 26).

Reiniging van de trechter voor het inbrengen van de voorgemalen koffie

- Controleer periodiek (circa eens per maand) of de trechter voor het inbrengen van voorgemalen koffie niet verstopt is (fig. 21).



Gevaar! Voordat reinigingswerkzaamheden worden uitgevoerd, dient men het apparaat uit te schakelen door op de hoofdschakelaar (A23) te drukken en het los te koppelen van het elektriciteitsnet. Dompel het apparaat nooit onder in water.

Reiniging van de binnenkant van het apparaat

1. Controleer periodiek (circa eens per week) of de binnenkant van het apparaat niet vuil is. Verwijder indien nodig de aangekoekte koffieresten met een sponsje.
2. Zuig de resten op met een stofzuiger (fig. 30).

Reiniging van de koffiezeteenheid

De koffiezeteenheid moet minstens eens per maand gereinigd worden.



Attentie! De koffiezeteenheid (A5) kan niet verwijderd worden wanneer het apparaat is ingeschakeld. Probeer de koffiezeteenheid niet op

krachtige wijze te verwijderen.

1. Controleer of het apparaat zich correct heeft uitgeschakeld (zie “Uitschakeling”).
2. Open het servicedeurtje (fig. 16).
3. Verwijder het drupbakje en het koffiedikreservoir (fig. 17).
4. Druk de twee rode ontgrendeltoetsen naar binnen en verwijder tegelijkertijd de koffiezettenheid (fig. 31).

! **Attentie!** Reinig de koffiezettenheid zonder reinigingsmiddelen te gebruiken, want de binnenkant van de zuiger is behandeld met een smeermiddel dat door het reinigingsmiddel verwijderd zou kunnen worden

5. Dompel de koffiezettenheid circa 5 minuten in water onder en spoel hem vervolgens af.
6. Breng de koffiezettenheid (A5) na reiniging weer aan door hem in de steun en de onderste pen te steken;

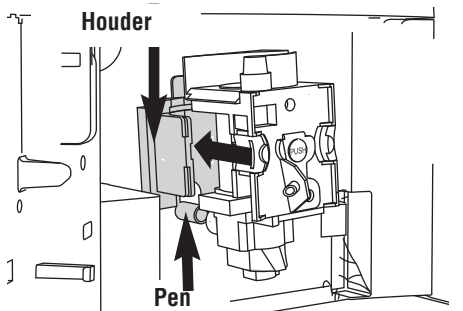

druk vervolgens op het opschrift PUSH totdat de “klik” van vergrendeling wordt gehoord.

i **Nota Bene!** Indien de koffiezettenheid moeilijk in te brengen is, is het noodzakelijk (alvorens hem te plaatsen) hem op de juiste maat te brengen door tegelijk krachtig te drukken op de onder- en bovenkant, zoals aangegeven in figuur.

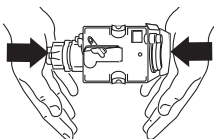

7. Controleer of na het inbrengen de twee rode

toetsen naar buiten zijn gesprongen.

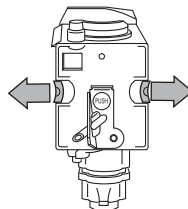

8. Breng het drupbakje met het koffiedikreservoir weer in.
9. Sluit het servicedeurtje.

DE MENUPARAMETERS WIJZIGEN EN INSTELLEN



Wanneer het apparaat klaar is voor gebruik, kunnen binnen het menu de volgende parameters of functies gewijzigd worden:

- Kies taal
- Spoelen
- Uitschakeltijd
- Instellen Klok
- Starttijd
- Autostart
- Temperatuur
- Waterhardheid
- Koffieprogramma
- Heetwater programma
- Ontkalken
- Reset fabrieksinst.
- Statistiek-modus
- Installeer filter
- Reset filter
- Zoemer
- Contrast

Instelling van de taal

Ga als volgt te werk om de taal op het display te wijzigen:

- Druk op het pictogram (B2) om het menu te openen; op het display verschijnt “KIES TAAL”.
- Druk op het pictogram (B9).
- Gebruik de pictogrammen (B7) en (B8) tot de gewenste taal wordt getoond.

- Druk op het pictogram  (B9) om te bevestigen.
- Druk op het pictogram  (B6) om het menu af te sluiten.

i **Nota Bene!** Als per ongeluk de verkeerde taal wordt gekozen, kan het menu rechtstreeks worden geopend om deze parameter te wijzigen:

- Houd het pictogram  (B2) minstens 7 seconden ingedrukt totdat het apparaat de diverse talen weergeeft.
- Kies de gewenste taal door te werk te gaan zoals beschreven in de paragraaf “Eerste gebruik van het apparaat”.

Spoelen

Deze functie dient om warmere koffie te verkrijgen. Ga als volgt te werk:





- Wanneer u, meteen nadat u het apparaat ingeschakeld hebt, een klein kopje koffie wilt zetten (minder dan 60 cc), gebruik dan het warme spoelwater om het kopje voor te verwarmen.
- Indien evenwel na de laatst gezette kop koffie meer dan 2/3 minuten zijn verstreken, wordt aangeraden de koffiezeteenheid, alvorens een nieuw kopje te zetten, voor te verwarmen door te drukken op het pictogram  (B2) om het menu te openen en vervolgens op de pictogrammen   (B7) en (B8) tot de functie “SPOELEN” wordt geselecteerd. Druk op het pictogram  (B9). Het display toont “SPOELEN BEVESTIG AUB”. Druk nogmaals op het pictogram  (B9). Laat het water in het onderstaande drupbakje lopen of gebruik dit water om het kopje waaruit de koffie gedronken wordt te vullen (en vervolgens te ledigen), met de bedoeling het voor te verwarmen.

Wijziging van de uitschakeltijd











Het apparaat is in de fabriek ingesteld om 30 minuten na het laatste gebruik automatisch uit te schakelen. Ga als volgt te werk om dit tijdsinterval te wijzigen (max. 120 min.):

- Druk op het pictogram  (B2) om het menu te openen en druk vervolgens op de

pictogrammen   (B7) en (B8) totdat de volgende melding verschijnt: “UIT-SCHAKELTIJD”.

- Druk op het pictogram  (B9) om te bevestigen.
- Druk op de pictogrammen   (B7) en (B8) om te bepalen na hoeveel tijd het apparaat uitgeschakeld moet worden (1/2 uur, 1 uur, 2 uur).
- Druk op het pictogram  (B9) om te bevestigen.
- Druk op het pictogram  (B6) om af te sluiten.

Instelling van de klok

- Druk op het pictogram  (B2) om het menu te openen en druk vervolgens op de pictogrammen   (B7) en (B8) totdat de volgende melding verschijnt: “INSTELLEN KLOK”.
- Druk op het pictogram  (B9).
- Gebruik de pictogrammen   (B7) en (B8) om de uren in te stellen en druk op het pictogram  (B9) om te bevestigen.
- Gebruik de pictogrammen   (B7) en (B8) om de minuten in te stellen en druk op het pictogram  (B9) om te bevestigen. Druk op het pictogram  (B6) om het menu af te sluiten.

Instelling van het tijdstip van automatische inschakeling







Met deze functie wordt het tijdstip geprogrammeerd waarop het apparaat automatisch inschakelt.

- Controleer of de klok van het apparaat ingesteld is.
- Druk op het pictogram  (B2) om het menu te openen en druk vervolgens op de pictogrammen   (B7) en (B8) totdat de volgende melding verschijnt: “STARTTIJD”.
- Druk op het pictogram  (B9).
- Gebruik de pictogrammen   (B7) en (B8) om de starttijd in te stellen en druk op het pictogram  (B9) om te bevestigen.
- Gebruik de pictogrammen   (B7) en (B8) om de minuten in te stellen en druk op het pictogram  (B9) om te bevestigen.

- Druk, om de functie “automatische start” te activeren, op de pictogrammen   (B7) en (B8) tot het apparaat de melding “AUTOSTART” toont.
- Druk op het pictogram  (B9) om te bevestigen. Op het display verschijnt het symbool .
- Druk op het pictogram  (B6) om het menu af te sluiten.
- Om de functie automatisch inschakelen te deactiveren, druk op het icoon  (B2) en daarna op de iconen   (B7) en (B8) tot de machine het bericht “AUTO INSCHAKELING” weergeeft. Druk op het icoon  (B9). Op het display verschijnt “BEVESTIGEN”. Druk op  om te deactiveren en het symbool  verdwijnt.

Wijziging van de koffietemperatuur

Om de temperatuur van de gezette koffie te wijzigen, als volgt te werk gaan:

- Druk op het pictogram  (B2) om het menu te openen en druk vervolgens op de pictogrammen   (B7) en (B8) totdat de volgende melding verschijnt: “TEMPERATUUR”.
- Druk op het pictogram  (B9).
- Gebruik de pictogrammen   (B7) en (B8) om de gewenste koffietemperatuur te wijzigen. laag, gemiddeld, hoog.
- Druk op het pictogram  (B9) om de gekozen temperatuur te bevestigen.
- Druk op het pictogram  (B6) om het menu af te sluiten.

Programmering van de hardheid van het water

Deze werkingsperiode kan worden verlengd, waardoor de ontkalking minder frequent wordt uitgevoerd. Dit gebeurt door het apparaat op basis van het werkelijke kalkgehalte in het gebruikte water te programmeren. Ga als volgt te werk:

- verwijder het reageerstrookje “Total hardness test uit zijn verpakking (bijgevoegd op pag. 2) en dompel het enige seconden volledig onder in een glas water. Neem het uit het water en wacht circa 30 seconden (totdat het van kleur verandert en rode vierkantjes ver-

schijnen).

- schakel het apparaat in door op de inschakel-/standbyknop (A7) te drukken.
- Druk op het pictogram  (B2) om het menu te openen en druk vervolgens op de pictogrammen   (B7) en (B8) totdat de volgende melding verschijnt: “WATERHARDHEID”.
- Druk op het pictogram  (B9).
- Druk op de pictogrammen   (B7) en (B8) totdat het nummer is geselecteerd dat overeenkomt met het aantal rode vierkantjes dat op het reageerstrookje is verschenen (als er bijvoorbeeld 3 rode vierkantjes op het reageerstrookje zijn verschenen, moet de melding “WATERHARDHEID 3” geselecteerd worden);
- Druk op het pictogram  (B9) om het gegeven te bevestigen. Nu is het apparaat geprogrammeerd om de ontkalkingswaarschuwing te geven wanneer dit daadwerkelijk nodig is.

Programmering koffie

Zie voor de aanwijzingen voor de programmering van de koffie het hoofdstuk “DE HOEVEELHEID KOFFIE IN HET KOPJE WIJZIGEN”.

Programmering heet water

Zie voor de aanwijzingen het hoofdstuk “DE HOEVEELHEID HEET WATER WIJZIGEN”.

Ontkalking



Attentie! Het ontkalkingsproduct bevat zuren. Neem de veiligheidsvoorschriften van de fabrikant die op de verpakking van het ontkalkingsproduct zijn aangegeven in acht.



Nota Bene! Gebruik uitsluitend een ontkalkingsproduct dat door de fabrikant wordt aanbevolen. In tegengesteld geval is de garantie niet geldig. Bovendien is de garantie niet geldig als de ontkalking niet regelmatig wordt uitgevoerd.



Attentie! Controleer, voordat u met het ontkalken begint, of het waterfilter verwijderd is.

Wanneer de melding “GRAAG ONTKALKEN” verschijnt, is het moment aangebroken om de ontkalking van het apparaat uit te voeren.

Ga als volgt te werk:

- controleer of het apparaat klaar is voor gebruik;
- Druk op het pictogram  (B2) om het menu te openen en druk vervolgens op de pictogrammen   (B7) en (B8) totdat de volgende melding verschijnt: “ONTKALKEN”.
- Druk op het pictogram  (B9) en de volgende melding verschijnt: “ONTKALKEN BEVESTIG AUB”;
- Druk op het pictogram  (B9).
Op het display verschijnt het opschrift “VOEG ONTKALKER TOE BEVESTIG AUB”.
- Ledig de watertank, giet de inhoud van een flacon ont kalkingsmiddel in de tank met inachtneming van de aanwijzingen op de verpakking. Voeg water toe tot het MAX. niveauteken dat op de tank is gedrukt. Plaats een bak met een inhoud van ongeveer 2 liter onder het waterpijpje.
- Druk op het pictogram  (B9), waarna de oplossing met ont kalkingsmiddel uit het waterpijpje begint te lopen en de onderstaande kan vult. Op het display verschijnt de melding “ONTKALKEN”.
- Het ont kalkingsprogramma voert automatisch een aantal keren afgifte en pauzes uit.
- Na circa 30 minuten verschijnt de melding “ONTKALKING AFGEROND BEVESTIG AUB”.
- Druk op het pictogram  (B9) en de volgende melding verschijnt: “SPOELEN BEVESTIG AUB”.
- Leeg de watertank, spoel hem om resten ont kalkingsmiddel te verwijderen, en vul hem met schoon water.
- Breng de tank vol met schoon water weer aan. Op het display verschijnt het opschrift “SPOELEN BEVESTIG AUB”.
- Druk opnieuw op het pictogram  (B9). Het hete water komt uit het pijpje, vult de onderstaande kan en de volgende melding verschijnt: “SPOELEN”;
- Wacht op de melding “SPOELEN AFGEROND BEVESTIG AUB”.
- Druk op het pictogram  (B9). Op het di-

splay verschijnt het opschrift “ONTKALKING AFGEROND” en vervolgens “VUL TANK”.

Vul de watertank opnieuw met schoon water.

- Het ont kalkingsprogramma is nu afgelopen en het apparaat is klaar om opnieuw koffie te zetten.

OPMERKING: Als men het ont kalkingsprogramma vóór het einde onderbreekt, moet men weer van voren af aan beginnen.



! *Attentie!* DE GARANTIE VERVALT INDIEN DE ONTKALKING NIET REGELMATIG WORDT UITGEVOERD.

Herstellen van de fabrieksinstellingen (reset)

Het is mogelijk om terug te gaan naar de oorspronkelijke instellingen van het apparaat (zelfs nadat de gebruiker ze gewijzigd heeft), en wel als volgt:

- Druk op het pictogram  (B2) om het menu te openen en druk vervolgens op de pictogrammen   (B7) en (B8) totdat de volgende melding verschijnt: “RESET FABRIEKSINST.”.
- Druk op het pictogram  (B9) en de volgende melding verschijnt: “RESET FABRIEKSINST. BEVESTIG AUB”;
- Druk op het pictogram  (B9) om terug te gaan naar de fabrieksinstellingen.

Statistiek-modus

Met deze functie worden de statistische gegevens van het apparaat weergegeven.

- Druk op het pictogram  (B2) om het menu te openen en druk vervolgens op de pictogrammen   (B7) en (B8) totdat de volgende melding verschijnt: “STATISTIEK-MODUS”.
- Druk op het pictogram  (B9).
- Door op de pictogrammen   (B7) en (B8) te drukken, kan het volgende gecontroleerd worden:
 - Hoeveel kopjes koffie gezet zijn.
 - Hoeveel ont kalkingen uitgevoerd zijn.
 - Hoeveel liter water in totaal afgegeven is.
- Druk één maal op het pictogram  (B6) om







deze functie af te sluiten of druk twee maal op het pictogram  (B6) om het menu af te sluiten.

Zoemer

Met deze functie wordt de zoemer in- of uitgeschakeld die het apparaat inschakelt wanneer op één van de pictogrammen wordt gedrukt en wanneer accessoires worden aangebracht/verwijderd.



Nota Bene! Het apparaat is met geactiveerde zoemer ingesteld.

- Druk op het pictogram  (B2) om het menu te openen en druk vervolgens op de pictogrammen   (B7) en (B8) totdat de volgende melding verschijnt: "ZOEMER".
- Druk op het pictogram  (B9). Op het display verschijnt het opschrift "ZOEMER BEVESTIG AUB".
- Druk op het pictogram  (B6) om het geluidssignaal uit te schakelen of op het pictogram  (B9) om het in te schakelen.
- Druk op het pictogram  (B6) om het menu af te sluiten.

Contrastregeling

Ga als volgt te werk om het contrast van het display te verhogen of te verlagen:

- Druk op het pictogram  (B2) om het menu te openen en druk vervolgens op de pictogrammen   (B7) en (B8) totdat de volgende melding verschijnt: "CONTRAST".
- Druk op het pictogram  (B9).
- Druk op de pictogrammen   (B7) en (B8) totdat het gewenste contrast op het display verschijnt: de voortgangsbalk geeft het geselecteerde contrastniveau aan.
- Druk op het pictogram  (B9) om te bevestigen.
- Druk één maal op het pictogram  (B6) om deze functie af te sluiten of druk twee maal op het pictogram  (B6) om het menu af te sluiten.

Waterfilter

Zie voor de aanwijzingen over het waterfilter het

hoofdstuk "INSTALLATIE VAN HET FILTER".

UITSCHAKELING VAN HET APPARAAT

Elke keer dat het apparaat wordt uitgeschakeld, vindt een automatische spoeling plaats die niet onderbroken kan worden.



Gevaar brandwonden! Tijdens het spoelen loopt een beetje warm water uit de spuitmonden van de afgiftegroep van de koffie.

Let op dat u niet wordt geraakt door waterspatten. Druk, om het apparaat uit te schakelen, op de inschakel-/standbyknop (A7): Het apparaat voert het spoelen uit en schakelt zich vervolgens uit.



Nota Bene! Als het apparaat gedurende langere tijd niet gebruikt zal worden, zet dan ook de ON/OFF hoofdschakelaar (A23) aan de achterkant van het apparaat in de stand 0.

TECHNISCHE GEGEVENS

Spanning: 220-240 V~ 50/60 Hz max. 10A

Vermogensverbruik: 1350W

Druk: 15 bar

Inhoud waterreservoir: 1,8 liter

Afmetingen LxHxD: 594 x 455 x 398 mm

Gewicht: 23/24 kg





Het apparaat voldoet aan de volgende EG-richtlijnen:

- Laagspanningsrichtlijn 2006/95/EG en latere wijzigingen.
- EMC-richtlijn 2004/108/EG en latere wijzigingen.
- Europese reglementering Stand-by 1275/2008

De materialen en voorwerpen die bestemd zijn om met levensmiddelen in contact te komen zijn conform de voorschriften van de Europese verordening nr. 1935/2004.

MELDINGEN OP HET DISPLAY

WEERGEGEVEN MELDING	MOGELIJKE OORZAAK	OPLOSSING
VUL TANK	<ul style="list-style-type: none"> De watertank is leeg of verkeerd geplaatst. 	<ul style="list-style-type: none"> Vul de watertank en/of breng hem correct aan door hem volledig aan te duwen.
MAALT TE FIJN MAAL- GRAAD INSTELLEN <i>(en afwisselend)</i> DRUK OK	<ul style="list-style-type: none"> De maalgraad is te fijn en de koffie komt dus te langzaam naar buiten. Het apparaat slaagt er niet in koffie te zetten omdat er lucht in het hydraulische circuit aanwezig is. Mogelijke oorzaak de installatieprocedure van het filter is niet correct uitgevoerd. 	<ul style="list-style-type: none"> Draai de regelknop van de maalgraad één klik richting nummer 7. Controleer of het filter (A26) goed geïnstalleerd is en of de installatieprocedure correct uitgevoerd is.
MAALT TE FIJN MAAL- GRAAD INSTELLEN <i>(afgewisseld door)</i> DRUK OK <i>(en vervolgens)</i> VUL TANK	<ul style="list-style-type: none"> De tank is tijdens de afgifte verwijderd. 	<ul style="list-style-type: none"> Breng de tank aan en druk op het pictogram  (B9). Het display toont "HEET WATER DRUK OK". Druk nogmaals op het pictogram  (B9). Het apparaat keert terug naar de werkwijze "klaar voor gebruik".
LEEG KOFFIEDIKRESERVOIR	<ul style="list-style-type: none"> Het koffiedikreservoir (A4) is vol of er zijn meer dan drie dagen sinds de laatste afgifte verstreken (deze handeling garandeert een correcte hygiëne van het apparaat). 	<ul style="list-style-type: none"> Ledig het reservoir, reinig het en breng het weer aan. Belangrijk: wanneer het drupbakje wordt verwijderd, moet het koffiedikreservoir VERPLICHT geleedigd worden, ook al is het niet vol. Doet u dit niet, dan kan het gebeuren dat bij het zetten van de volgende kopjes koffie, het koffiedikreservoir te vol raakt en het apparaat verstopt raakt.
PLAATS KOFFIEDIKRESERVOIR	<ul style="list-style-type: none"> Na de reiniging is het koffiedikreservoir niet aangebracht. 	<ul style="list-style-type: none"> Open het deurtje en breng het koffiedikreservoir aan.

WEERGEGEVEN MELDING	MOGELIJKE OORZAAK	OPLOSSING
VOEG VOORGEMALEN KOFFIE TOE	<ul style="list-style-type: none"> • De functie “voorgemalen koffie” is geselecteerd, maar er is geen voorgemalen koffie in de trechter gedaan. • De trechter (A21) is verstopt. 	<ul style="list-style-type: none"> • Trek het apparaat uit en doe de voorgemalen koffie in de trechter. • Ledig de trechter met behulp van een mes zoals beschreven in de paragraaf “Reiniging van de trechter voor het inbrengen van voorgemalen koffie”.
GRAAG ONTKALKEN!	<ul style="list-style-type: none"> • Geeft aan dat het apparaat ontkalkt moet worden. 	<ul style="list-style-type: none"> • Het ontkalkingsprogramma beschreven in de paragraaf “Ontkalking” moet zo snel mogelijk uitgevoerd worden.
MINDER KOFFIE	<ul style="list-style-type: none"> • Er is te veel koffie gebruikt. 	<ul style="list-style-type: none"> • Kies een lichter aroma of gebruik minder voorgemalen koffie en zet opnieuw koffie.
VUL KOFFIEBONENRESERV.	<ul style="list-style-type: none"> • De koffiebonen zijn op. 	<ul style="list-style-type: none"> • Vul het reservoir met koffiebonen.
PLAATS KOFFIEZETEENHEID	<ul style="list-style-type: none"> • Na het reinigen is de zeteenheid niet aangebracht. 	<ul style="list-style-type: none"> • Breng de zeteenheid aan zoals beschreven in de paragraaf “Reiniging van de koffiezeteenheid”.
DOE DEUR DICHT	<ul style="list-style-type: none"> • Het deurtje is open 	<ul style="list-style-type: none"> • Sluit het deurtje.
ALGEMEEN ALARM!	<ul style="list-style-type: none"> • De binnenkant van het apparaat is zeer vuil. 	<ul style="list-style-type: none"> • Reinig het apparaat zorgvuldig zoals beschreven in de paragraaf “Reiniging en onderhoud”. Als het apparaat na de reiniging nog steeds de melding laat zien, zich tot een servicecentrum wenden.
VERVANG FILTER!	<ul style="list-style-type: none"> • Geeft aan dat het waterfilter (A26) vervangen moet worden. 	<ul style="list-style-type: none"> • Vervang meteen het filter volgens de aanwijzingen in de paragraaf “Vervanging van het filter”.

OPLOSSING VAN PROBLEMEN

Hieronder zijn enkele mogelijke storingen opgesomd. Als het probleem niet op de beschreven manier opgelost kan worden, moet contact worden opgenomen met de Technische Service.

PROBLEEM	MOGELIJKE OORZAAK	OPLOSSING
De koffie is niet warm.	<ul style="list-style-type: none"> • De kopjes zijn niet voorverwarmd • De koffiezeteenheid is koud geworden omdat er 2/3 minuten sinds de laatste koffie zijn verstreken. • De ingestelde temperatuur is te laag. 	<ul style="list-style-type: none"> • Verwarm de kopjes door ze met warm water af te spoelen. • Alvorens koffie te zetten, de zetgroep verwarmen met de functie SPOELEN binnen het menu. • Wijzig de ingestelde temperatuur (zie de paragraaf “Wijziging van de koffietemperatuur”).
De koffie heeft weinig crème.	<ul style="list-style-type: none"> • De koffiebonen zijn te grof gemalen • De koffiemelange die gebruikt wordt is niet geschikt. 	<ul style="list-style-type: none"> • Draai de regelknop van de maalgraad één klik linksom richting nummer 1 terwijl de koffiemolen werkt (fig. 11). • Gebruik een koffiemelange voor espressoapparaten.
De koffie wordt te langzaam of druppelsgewijs afgegeven.	<ul style="list-style-type: none"> • De koffiebonen zijn te fijn gemalen 	<ul style="list-style-type: none"> • Draai de regelknop van de maalgraad één klik rechtsom richting nummer 7 terwijl de koffiemolen werkt (fig. 11). Ga steeds één klik verder, totdat de gewenste afgifte wordt verkregen. Het effect is pas duidelijk na de afgifte van 2 kopjes koffie.

PROBLEEM	MOGELIJKE OORZAAK	OPLOSSING
De koffie wordt te snel afgegeven.	<ul style="list-style-type: none"> De koffiebonen zijn te grof gemalen 	<ul style="list-style-type: none"> Draai de regelknop van de maalgraad één klik linksom richting nummer 1 terwijl de koffiemolen werkt (fig. 11). Let erop dat de regelknop van de maalgraad niet te veel wordt verdraaid, want anders kan de afgifte druppelsgewijs gebeuren als er twee kopjes koffie worden gezet. Het effect is pas duidelijk na de afgifte van 2 kopjes koffie.
De koffie loopt niet uit een of beide spuitmonden van de afgiftegroep.	<ul style="list-style-type: none"> De spuitmonden zijn verstopt. 	<ul style="list-style-type: none"> Reinig de spuitmonden met een tandenstoker (fig. 23).
De koffie loopt niet uit de spuitmonden van de afgiftegroep, maar langs het deurtje (A2).	<ul style="list-style-type: none"> De gaatjes in de spuitmonden zijn verstopt door opgedroogde koffieresten. Het koffietoevoerlaatje (A3) in het deurtje is geblokkeerd. 	<ul style="list-style-type: none"> Reinig de spuitmonden met een tandenstoker, een sponsje of een keukenborstel met harde haren (fig. 23). Reinig het koffietoevoerlaatje (A3) zorgvuldig, vooral in de buurt van de scharnieren.
Uit de afgiftegroep komt geen koffie maar water.	<ul style="list-style-type: none"> De voorgemalen koffie is in de trechter (A21) blijven vastzitten. 	<ul style="list-style-type: none"> Reinig de trechter (A21) met een houten of plastic vork, reinig de binnenkant van het apparaat.

CONTENTS

INTRODUCTION	7
Symbols used in these instructions	7
Letters in brackets	7
Troubleshooting and repairs	7
SAFETY	7
Fundamental safety warnings	7
Designated use	8
Instructions	8
DESCRIPTION	8
Description of the appliance	8
Description of the control panel	8
PRELIMINARY CHECKS	9
Controls after transport	9
Installing the appliance	9
Connecting the appliance	9
DISPOSAL	9
BUILT-IN INSTALLATION	10
USING THE APPLIANCE FOR THE FIRST TIME	12
Installing the filter	12
Replacing the filter	13
Removing the filter	13
TURNING ON AND HEATING UP ...	13
MAKING COFFEE USING COFFEE BEANS	14
CHANGING THE QUANTITY OF COFFEE IN THE CUP	15
ADJUSTING THE COFFEE MILL	15
MAKING ESPRESSO COFFEE WITH PRE-GROUND COFFEE (INSTEAD OF BEANS)	15
DELIVERING HOT WATER	16
CHANGING THE QUANTITY OF HOT WATER	16
MAKING CAPPUCCINO (USING THE STEAM FUNCTION)	16
CLEANING	17
Cleaning the coffee maker	17
Cleaning the waste coffee container	17
Cleaning the drip tray	17
Cleaning the water tank	17
Cleaning the spouts	17
Cleaning the pre-ground coffee funnel	17
Cleaning the inside of the coffee maker	18
Cleaning the brewing unit	18
CHANGING AND SETTING MENU PARAMETERS	18
Setting the language	19
Rinsing	19
Changing the length of time the appliance remains on	19
Setting the clock	19
Setting auto-start time	19
Changing coffee temperature	20
Setting water hardness	20
Programming coffee	20
Programming water	20
Descaling	20
Resetting default values (reset)	21
Statistics	21
Buzzer	21
Adjusting contrast	21
Water filter	22
TURNING THE APPLIANCE OFF ...	22
TECHNICAL SPECIFICATION	22
DISPLAYED MESSAGES	23
TROUBLESHOOTING	25

INTRODUCTION

Symbols used in these instructions

Important warnings are identified by these symbols. Failure to observe the instructions could result in electric shock, serious injury, burns, fire or damage to the appliance.



Danger!

Failure to observe the warning could result in possibly life threatening injury from electric shock.



Important!

Failure to observe the warning could result in injury or damage to the appliance.



Danger of burns!

Failure to observe the warning could result in scalds or burns.



N.B.!

Important information for the user

Letters in brackets

The letters in brackets refer to the legend in the Description of the Appliance on page 3.

Troubleshooting and repairs

In the event of problems, follow the information given in the sections "Displayed messages" and "Troubleshooting".

If this does not resolve the problem, you should consult Customer Services.

For repairs, contact Customer Services only.

SAFETY

Fundamental safety warnings



Important! This is an household appliance only.

It is not intended to be used in:

- staff kitchen areas in shops, offices and other

working environments;

- farm houses;
- by clients in hotels, motels and other residential type environments;
- bed and breakfast type environments.



Danger! This is an electrical appliance, it is therefore important to respect the following safety warnings:

- Never touch the appliance with damp hands.
- Never touch the plug with damp hands.
- Make sure the socket used is freely accessible at all times, enabling the appliance to be unplugged when necessary.
- If the appliance is faulty, do not attempt to repair.

Turn it off using the main switch (A23), unplug from the mains socket and contact Customer Services.



Important! Keep all packaging (plastic bags, polystyrene foam) away from children.



Important! The appliance is not intended for use by persons (including children) with reduced physical, sensory or mental capabilities, or lack of experience and knowledge, unless they have been given supervision or instruction concerning use of the appliance by a person responsible for their safety.

Children must be supervised to ensure they do not play with the appliance.





Danger of burns! This appliance produces hot water and steam may form while it is in operation.

Avoid contact with splashes of water or hot steam. Use knobs and handles.



Important! Do not grasp the coffee maker when it is out of the cabinet. Do not rest recipients containing liquids or inflammable or corrosive materials on top of the appliance. Place the accessories required to make the coffee (the measure for example) in the special holder. Do not rest large objects which could obstruct movement or unstable objects on the appliance.

 **Important!** Do not use the appliance when extracted. Make sure the appliance is inactive before extracting it. The only exception is adjusting the coffee mill which must be done with the machine out (see the section "Adjusting the coffee mill").

 **N.B.!** Use original or manufacturer recommended accessories and spare parts only.

Designated use

This appliance is designed and made to prepare coffee and heat drinks.

All other use is considered improper.

This appliance is not suitable for commercial use. The manufacturer is not liable for damage deriving from improper use of the appliance.

This appliance can be installed over a built-in oven if the latter is fitted with a cooling fan at the rear (maximum microwave power: 3 kW).

Instructions

Read these instructions carefully before using the appliance.

- Keep these instructions
- Failure to respect these instructions may result in burns or damage to the appliance.
The manufacturer is not liable for damage deriving from failure to respect these instructions.

 **N.B.!** The appliance has a cooling fan. This comes on whenever coffee, steam or hot water is delivered. After several minutes, the fan goes off automatically.

DESCRIPTION

Description of the appliance

(page 3 - **A**)

- A1. Cup tray
- A2. Service door
- A3. Coffee guide
- A4. Waste coffee container
- A5. Brewing unit







- A6. Cup tray lights
- A7. On/OFF/stand-by button
- A8. Control panel
- A9. IEC connector
- A10. Cappuccino maker (removable)
- A11. Cappuccino maker nozzle
- A12. Water tank
- A13. Coffee spout (adjustable height)
- A14. Drip tray
- A15. Bean container lid
- A16. Bean container
- A17. Grinding adjustment knob
- A18. Pre-ground coffee funnel door
- A19. Measure
- A20. Compartment for measure
- A21. Pre-ground coffee funnel
- A22. Power cable
- A23. Main switch
- A24. Tray
- A25. Water softener filter (optional)





Description of the control panel

(page 3 - **B**)

 **N.B.!** Only the icons relating to the controls enabled for the particular function currently being used will be lit on the touch screen.

 **N.B.!** A light touch is enough to activate the icon.

- B1. Display: guides the user in using the appliance.
- B2.  icon to activate or deactivate menu parameter setting mode
- B3.  icon to turn light A6 on and off
- B4.  icon to select the coffee taste
- B5.  icon to select the type of coffee (espresso, small cup, medium cup, large cup, mug)
- B6.  icon to exit the selected mode
- B7-B8.   icons to scroll forwards or backwards through the menu and display the various modes

- B9.  icon to confirm the selected function
- B10.  icon to deliver a cup of coffee
- B11.  icon to deliver two cups of coffee
- B12.  icon to deliver steam
- B13.  icon to deliver hot water

PRELIMINARY CHECKS

Controls after transport

After removing the packaging, make sure the product is complete and undamaged and that all accessories are present.

Do not use the appliance if it is visibly damaged. Contact Customer Services.

Installing the appliance



Important!

- Installation must be performed by a qualified professional in compliance with legislation in force in the country of installation (see Built-in installation).
- The packing elements (plastic bags, polystyrene foam, etc.) should be kept out of reach of children.
- Do not install the appliance in rooms where the temperature may drop to 0°C or lower.
- Customise the water hardness as soon as possible following the instructions in the "Setting water hardness" section.

Connecting the appliance



Danger! Check that the mains power supply voltage corresponds to the value indicated on the rating plate on the bottom of the appliance.

Connect the appliance to an efficiently earthed and correctly installed socket with a minimum current rating of 10A only.

If the power socket does not match the plug on the appliance, have the socket replaced with a suitable type by a qualified professional.

To comply with safety directives, an omnipolar

switch with a minimum contact distance of 3 mm must be installed.

Do not use multiple sockets or extensions.



Important! Safety cutout devices must be included in the mains power supply in compliance with the installation regulations in the country concerned.

DISPOSAL



Electrical appliances must not be disposed of as household waste.

Appliances with this symbol are covered by European Directive 2002/96/EC.

All unused electric and electronic appliances must be disposed of separately from household waste by taking them to state authorised special centres.

Disposing of the unused appliance correctly avoids damage to the environment and a risk to health.

For more information on disposing of the unused appliance, contact the local administration, the waste disposal department or the shop where the appliance was bought.

BUILT-IN INSTALLATION

Verify the minimum measurements required for correct installation of the appliance.

The coffee maker must be installed in a column and the column must be firmly fixed to the wall with commercially available brackets.

Important:

- Important: all installation or maintenance operations must be performed with the appliance disconnected from the mains electricity supply.
- Kitchen furniture in direct contact with the appliance must be heat resistant (65°C min).
- To guarantee correct ventilation, leave a gap at the bottom of the cabinet (see measurements in figure).

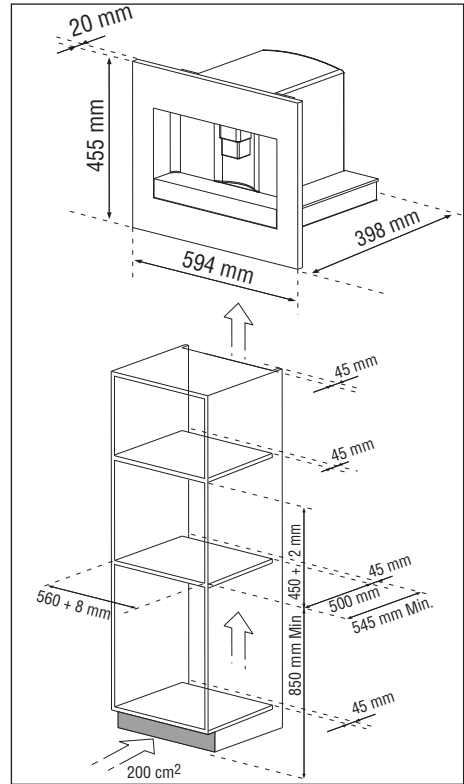
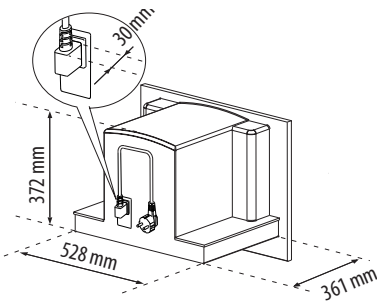

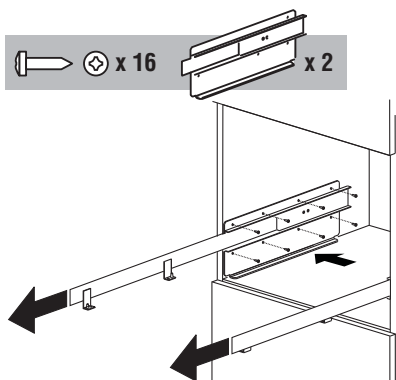

Position the rails on the sides of the cabinet as shown in the figure. Fix with the screws, then extract them completely. If the coffee maker is installed over a warmer drawer, use the top surface of this as a reference to position the rails. In this case, there will be no surface to rest the rails on.

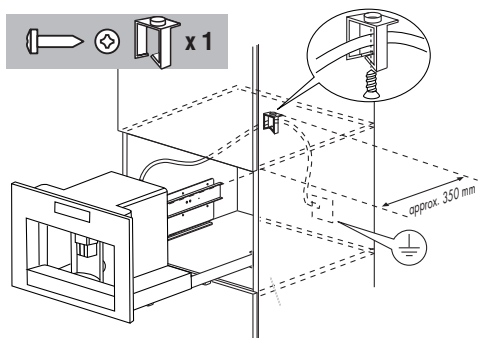

Fix the power cable with the clip. The power cable must be long enough to allow the appliance to be extracted from the cabinet to fill the coffee bean container.

The appliance must be earthed in compliance with legislation.

Electrical connections must be performed by a qualified electrician following the instructions.

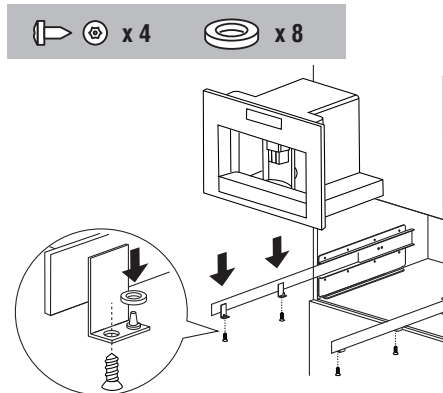



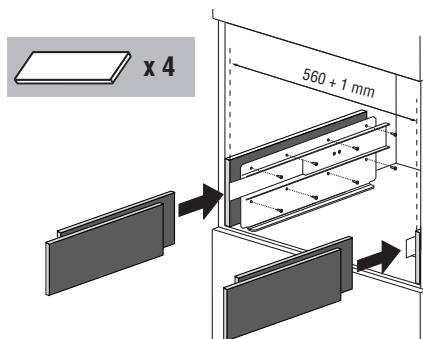

Position the appliance on the rails, making sure the pins are correctly inserted in the housings, then fix it with the screws supplied. If the height of the appliance requires adjusting, use the spacer disks provided.





If necessary, correct alignment of the appliance by positioning the spacers supplied under or at the sides of the support.

USING THE APPLIANCE FOR THE FIRST TIME

- Coffee has been used to factory test the appliance and it is therefore completely normal for there to be traces of coffee in the mill.
 - Customise water hardness as soon as possible following the instructions in the "Setting water hardness" section.
1. Connect the appliance to the mains supply. Set the required language.
 2. To set the language, use the   icons (B7 and B8) to choose the required language (fig. 2). When the message "PRESS OK TO CHOOSE ENGLISH" is displayed, press the  icon (B9) (fig. 3) for 3 seconds until "ENGLISH INSTALLED" is displayed. If you set the wrong language, follow the instructions in the "Setting the language" section. If your language is not available, select one from those displayed. The instructions refer to the English version. Then follow the instructions displayed:
 3. After 5 seconds, the appliance displays "FILL TANK". Extract the water tank (fig. 4), rinse and fill with fresh water without exceeding the MAX line. Replace and push as far as it will go. A water softener filter can be installed in the tank (fig. 29).
 4. Place a cup under the cappuccino maker (fig. 5). The appliance displays: "HOT WATER PRESS OK". Press the  icon (B9) (fig. 3) and after a few seconds a little water comes out of the cappuccino maker.
 5. The machine now displays "TURNING OFF... PLEASE WAIT" and goes off.
 6. Extract the appliance by pulling it out using the handles (fig. 6). Open the lid and fill the container with coffee beans, then close the lid and push the appliance in.

The coffee maker is now ready for normal use.

 **Important!** Never introduce pre-ground coffee, freeze dried coffee, caramelised beans or anything else which could damage the appliance.

 **N.B.!** When using the appliance for the

first time, you need to make 4-5 cups of coffee and 4-5 cappuccinos before the appliance gives satisfactory results.

 **N.B.!** Each time you turn the coffee maker on by the ON/OFF switch (A23), it performs a SELF-DIAGNOSIS cycle and then goes off. To turn it on again, press the ON/OFF button (A7) (fig. 1)

Installing the filter

Some models are fitted with a water softener filter to improve the quality of the water used and extend the working life of the appliance.







To install, proceed as follows:

1. Remove the filter from the packaging;
2. Slide the date indicator pointer (see fig. 29) until the months of use are displayed.

 **N.B.!** The filter lasts about two months if the appliance is used normally. If the coffee maker is left unused with the filter installed, it will last a maximum of three weeks.

3. Fill the tank with a little water up to the level shown in the figure:



4. Insert the filter in the water tank and press it until it touches the bottom of the tank (see fig. 29);
5. Fill the water tank and insert in the coffee maker;
6. Place a container underneath the cappuccino maker (min. capacity: 100 ml).
7. Press the  icon (B2) to enter the menu;
8. Press the   icons (B7) and (B8) until "INSTALL FILTER" is displayed;
9. Press the  icon (B9);
10. The message "INSTALL FILTER PLEASE CONFIRM" is displayed.
11. Press the  icon (B9) to confirm the selection (or  (B6) to cancel). "HOT WATER PRESS OK" is displayed.
12. Press the  icon (B9) again. The ap-







pliance begins delivering hot water and the message "PLEASE WAIT..." is displayed.

When delivery stops, the appliance automatically displays the basic modes set again.

 **N.B.!** The appliance may request the operation to be repeated a number of times until the air is completely eliminated from the hydraulic circuit.

Replacing the filter ("FILTER RESET")







When "REPLACE FILTER" is displayed or after 2 months of use (see date indicator), the filter must be replaced:

1. Remove the exhausted filter;
2. Remove the new filter from the packaging.
3. Slide the pointer of the date indicator (see fig. 29) until the months of use are displayed (the filter lasts about 2 months);
4. Insert the filter in the water tank and press it until it touches the bottom of the tank (see fig. 29);
5. Fill the water tank and insert in the coffee maker;
6. Turn the cappuccino maker outwards and place a container underneath (min. capacity 100 ml).
7. Press the  icon (B2) to enter the menu;
8. Press the   icons (B7) and (B8) until "FILTER RESET" is displayed;
9. Press the  icon (B9);
10. The message "FILTER RESET CONFIRM" is displayed.
11. Press the  icon (B9) to confirm the selection (or  (B6) to cancel). "HOT WATER PRESS OK" is displayed.
12. Press the  icon (B9) again. The appliance begins delivering hot water and the message "PLEASE WAIT..." is displayed. When delivery stops, the appliance automatically displays the basic modes set again.

Removing the filter

To use the appliance without a filter, you must remove it and notify the appliance of its removal as

follows:

1. Press the  icon (B2) to enter the menu;
2. Press the   icons (B7) and (B8) until "INSTALL FILTER" is displayed;
3. Press the  icon (B9);
4. The message "INSTALL FILTER* CONFIRM" is displayed.
5. Press the  icon (B6).
6. When the asterisk has disappeared from the top right of the display, press  (B6) to exit the menu.

 **N.B.!** Use the filters recommended by the manufacturer only. Use of unsuitable filters could damage the appliance.

TURNING ON AND HEATING UP

Each time the appliance is turned on, it performs an automatic preheat and rinse cycle which cannot be interrupted. The appliance is ready for use only after completion of this cycle.

 **Danger of burns!** During rinsing, a little hot water flows from the coffee spouts.

To turn the appliance on, press the ON/OFF/stand-by button (A7) (fig. 1). The message "HEATING UP... PLEASE WAIT" is displayed. When heating is complete, the message changes to "RINSING"; The appliance is at temperature when the message "MEDIUM CUP NORMAL TASTE" is displayed. If no icon is pressed within about 2 minutes, the time (if set, see the "Setting the clock" section) is displayed. If the time has not been set, the appliance displays the last functions set. When any icon is pressed, "MEDIUM CUP NORMAL TASTE" is displayed again. The appliance is ready to make coffee again.

MAKING COFFEE USING COFFEE BEANS

1. The appliance is preset to make coffee with a

normal taste. You can also choose coffee with an extra-mild, mild, strong or extra-strong taste. There is also a pre-ground coffee option. To choose the required taste, press the ☑ icon (B4) (fig. 7). The required coffee taste is displayed.

2. Place 1 cup under the spouts to make 1 coffee (fig. 8) or 2 cups for 2 coffees (fig. 9). Lower the spouts as near as possible to the cup for a creamier coffee (fig. 10).
 3. Press the ☑ icon (B5) (fig. 11) to select the type of coffee: espresso, small cup, medium cup, large cup, mug. Now press the ☑ icon (B10) (fig. 12) if you want to make a coffee and the ☑ icon (B11) (fig. 13) if you want to make 2 coffees. The appliance now grinds the beans and starts delivering the coffee into the cup. Once the set amount of coffee has been delivered, the machine stops delivery automatically and expels the exhausted waste coffee into the waste coffee container.
 4. After a few seconds, the appliance is ready for use again.
 5. To turn the appliance off, press the ON/OFF/stand-by button (A7) (fig. 1).
- (Before going off, the appliance performs an automatic rinse cycle. Take care to avoid scalds).

NOTE 1: If the coffee is delivered a drop at a time or not at all, see the "Adjusting the coffee mill" section.

NOTE 2: If the coffee is delivered too fast and the cream is not satisfactory, see the "Adjusting the coffee mill" section.

NOTE 3: Tips for a hotter coffee:

- Proceed as described in the section "Changing and setting menu parameters", "Rinse" function.
- Unless preheated, do not use excessively thick cups as they will absorb too much heat.
- Preheat the cups by rinsing them with hot water.

NOTE 4: Coffee delivery can be interrupted at any moment by re-pressing the previously selected icon which remains lit during the operation.

NOTE 5: As soon as delivery is finished, to in-

crease the quantity of coffee in the cup, just keep pressing the previously selected icon within 3 seconds after delivery has finished.

NOTE 6: When the appliance displays "FILL TANK", fill the tank with water or the appliance will not deliver coffee. (It is normal for there to be a little water left in the tank).

NOTE 7: After about 14 single (or 7 double) coffees, the appliance displays "EMPTY WASTE COFFEE CONTAINER". To clean, open the service door on the front of the appliance by pulling the spout (fig. 16), extract the drip tray (fig. 17) and clean.

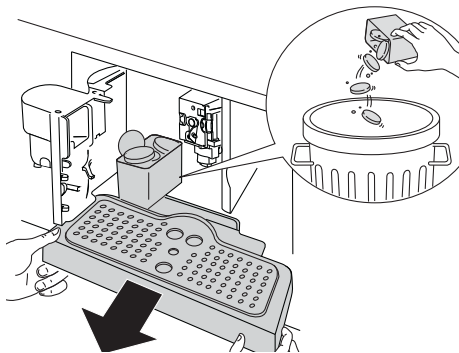

When cleaning, **always extract the drip tray completely.**

! Important! When extracting the drip tray, the waste coffee container **MUST** always be emptied. If this is not done, the machine may be clogged.

NOTE 8: Never extract the water tank while the machine is delivering coffee. If it is removed, it will not be possible to make the coffee and the appliance will display "GROUND TOO FINE ADJUST MILL AND PRESS OK" and then "FILL TANK". Check the level of water in the tank and replace in the appliance. To turn the machine on again, press the ☑ icon (B9). "HOT WATER PRESS OK" is displayed. Press the ☑ icon (B9) within a few seconds and deliver water from the cappuccino maker for about 30 seconds. When delivery stops, the basic modes are displayed again.

i N.B.: The coffee maker may request the operation to be repeated a number of times until the air is completely eliminated from the hydraulic circuit.













i N.B.: if this operation is not performed correctly or if the machine is turned off, the basic modes may be displayed, although the problem is in fact still present.

CHANGING THE QUANTITY OF COFFEE IN THE CUP

The appliance is set by default to automatically make the following types of coffee:

- espresso
- small cup
- medium cup
- large cup
- mug

To change the quantity, proceed as follows:

- Press the  icon (B2) to enter the menu (fig. 15). Press the   icons (B7) and (B8) (fig. 2) until "PROGRAM COFFEE" is displayed.
- Press the  icon (B9).
- Select the type of coffee you want to change by pressing the   icons (B7) and (B8).
- Press the  icon (B9) to confirm the type of coffee you want to make.
- Use the   icons (B7) and (B8) to change the quantity of coffee. The progress bar shows the quantity of coffee selected.
- Press the  icon (B9) again to confirm (or the  icon (B6) to cancel the operation).
- Press the  icon (B6) (fig. 18) twice to exit the menu.

The appliance is now reprogrammed with the new settings and is ready.

ADJUSTING THE COFFEE MILL

The coffee mill is preset in the factory and should not require adjusting. However, if after making the first few coffees you find that delivery is either too fast or too slow (a drop at a time), this can be corrected by adjusting the grinding adjustment knob (fig. 14).

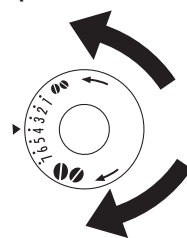

! **Important!** The grinding adjustment knob must only be turned when the coffee mill is in operation.



For slower delivery and creamier coffee, turn one click anticlockwise (finer pre-ground coffee).

For faster delivery (not a drop at a time), turn one click clockwise (coarser pre-ground coffee).

MAKING COFFEE USING PRE-GROUND COFFEE

- Press the  icon (B4) (fig. 7) and select the pre-ground coffee function.
- Extract the machine by pulling it outwards using the handles.
- Lift the central lid, place one measure of pre-ground coffee in the funnel (fig. 19), push the appliance in then proceed as described in the section "Making coffee using coffee beans".
N.B.: You can make just one coffee at a time by pressing the  icon (B10) (fig. 12).
- After using the machine with pre-ground coffee, to go back to making coffee using beans, deactivate the pre-ground coffee function by pressing the  icon (B4) (fig. 7).

NOTE 1: Never introduce pre-ground coffee when the machine is off or it could spread through the inside of the appliance.

NOTE 2: Never add more than 1 measure, otherwise the appliance will not make the coffee.





NOTE 3: Use the measure provided only.

NOTE 4: Introduce only pre-ground coffee for

espresso coffee machines into the funnel.

NOTE 5: If more than one measure of pre-ground coffee is used and the funnel clogs, push the coffee down with a knife (fig. 21) then remove and clean the brewing unit and machine as described in the "Cleaning the brewing unit" section.









DELIVERING HOT WATER

- Always make sure the appliance is ready.
- Turn the cappuccino maker outwards and place a container underneath (fig. 5).
- Press the  icon (B13) (fig. 20). The appliance displays: "HOT WATER PRESS OK". Press the  icon (B9) again and hot water is delivered from the cappuccino maker into the container underneath. You should not deliver hot water for more than 2 minutes at a time. To interrupt, press the  icon (B13) or the  icon (B6). The appliance stops delivery once the set quantity is reached.











CHANGING THE QUANTITY OF HOT WATER

The machine is set by default to automatically deliver 200 ml of hot water.

To change these quantities, proceed as follows:

- Place a container underneath the cappuccino maker (fig. 3).
- Press the  icon (B2) to enter the menu (fig. 15) or press the   icons (B7) and (B8) (fig. 2) until "PROGRAM HOT WATER" is displayed.
- Press the  icon (B9) to confirm.
- Select the required quantity of water by pressing the   icons (B7) and (B8). The progress bar shows the quantity of water selected.
- Press the  icon (B9) to confirm (or the  icon (B6) to cancel the operation.
- Press the  icon (B6) (fig. 18) twice to exit the menu.
- The appliance is now reprogrammed with the new settings and is ready.

MAKING CAPPUCCINO (USING THE STEAM FUNCTION)

- Turn the cappuccino maker towards the centre (fig. 5).
- Take a container, fill it with about 100 g of milk for each cappuccino to be made and place it under the cappuccino maker. In choosing the size of the recipient, bear in mind that the milk doubles or triples in volume. You are recommended to use partially skimmed milk at refrigerator temperature.
- Press the  icon (B12) (fig. 22). "STEAM PRESS OK" is displayed.
- Press the  icon (B9).
- To interrupt steam delivery, press the  icon (B12) again or the  icon (B6).
- Immerse the cappuccino maker in the milk container (fig. 23), taking care not to immerse it for more than half its length. Press the  icon (B12) (take care to avoid scalds) and press the  icon (B9). Steam comes out of the cappuccino maker. For a creamier froth, immerse the cappuccino maker in the milk and move the container with slow upward movements. You should not deliver steam for more than 2 minutes at a time.
- When the required temperature is reached, interrupt steam delivery by pressing the  icon (B12) again or the  icon (B6).
- Make the coffee as described above using sufficiently large cups, then fill them with the frothed milk prepared previously. **IMPORTANT:** always clean the cappuccino system immediately after use. Proceed as follows:
 - Press the  icon (B12) and then press the  button (B9) to discharge a small amount of steam for a few seconds. This empties the steam spout of all traces of milk. **IMPORTANT:** to ensure the hygiene of the appliance, you are recommended to carry out this procedure each time you make cappuccino to avoid stale milk remaining in the circuit.
- Wait for the cappuccino maker to cool down,

then holding the cappuccino maker lever firmly in one hand, unscrew the cappuccino maker itself with the other, turning it anticlockwise and removing it downwards (fig. 24).

- Remove the cappuccino maker nozzle by pulling it downwards.
- Wash the cappuccino maker and nozzle thoroughly in hot water.
- Make sure the two holes shown in figure 25 are not blocked. If necessary, clean with a pin.
- Replace the nozzle by inserting it upwards into the cappuccino maker.
- Replace the cappuccino maker by pushing it upwards and rotating it clockwise.

CLEANING

Cleaning the coffee maker

Do not use solvents or abrasive detergents to clean the coffee maker. A soft damp cloth will suffice. Never wash any of the components of the coffee maker in the dishwasher.

The following parts of the machine must be cleaned regularly:

- Waste coffee container (A4).
- Drip tray (A14).
- Water tank (A12).
- Coffee (A13), hot water (A11) and cappuccino maker spouts (A10).
- Pre-ground coffee funnel (A21).
- Inside of the machine, accessible after opening the service door (A2).
- Brewing unit (A5).
- Coffee jug.

Cleaning the waste coffee container

When "EMPTY WASTE COFFEE CONTAINER" is displayed, the waste coffee container must be emptied and cleaned. To clean:

- open the service door on the front of the appliance (fig. 16), extract the drip tray (fig. 17) and clean.
- Clean the waste coffee container thoroughly.



Important! When extracting the drip tray,

the waste coffee container must always be emptied.

Cleaning the drip tray



Important! If the drip tray is not emptied the water might overflow. This could damage the machine. The drip tray is fitted with a level indicator (red) showing the level of water it contains (fig. 27). Before the indicator protrudes from the cup tray, the drip tray must be emptied and cleaned. To remove the tray:

1. Open the service door (fig. 16).
2. Remove the drip tray and the waste coffee container (fig. 17).
3. Clean the drip tray and waste coffee container (A4).
4. Replace the drip tray and waste coffee container (A4).
5. Close the service door.

Cleaning the water tank

1. Clean the water tank (A12) regularly (about once a month) with a damp cloth and a little mild washing up liquid.
2. Remove all traces of washing up liquid.

Cleaning the spouts

1. Clean the nozzles periodically using a sponge (fig. 28).
2. Check regularly that the holes in the coffee spout are not blocked. If necessary, remove coffee deposits with a toothpick (fig. 26).

Cleaning the pre-ground coffee funnel

- Check regularly (about once a month) that the pre-ground coffee funnel is not blocked (fig. 21).



Danger! Before performing any cleaning operations, the machine must be turned off by pressing the main switch (A23) and unplugged from the mains power supply. Never immerse the coffee maker in water.

Cleaning the inside of the coffee maker

1. Check regularly (about once a week) that the inside of the appliance is not dirty. If necessary, remove coffee deposits with a sponge.
2. Remove the residues with a vacuum cleaner (fig. 30).

Cleaning the brewing unit

The brewing unit must be cleaned at least once a month.

! **Important!** The brewing unit (A5) must not be removed when the appliance is on. Do not use force to remove the brewing unit.

1. Make sure the machine is correctly turned off (see "Turning the appliance off").
2. Open the service door (fig. 16).
3. Remove the drip tray and waste coffee container (fig. 17);
4. Press the two red release buttons inwards and at the same time pull the brewing unit outwards (fig. 31).

! **Important!** Do not use washing up liquid to clean the brewing unit. It would remove the lubricant applied to the inside of the piston.

5. Soak the brewing unit in water for about 5 minutes, then rinse.
6. After cleaning, replace the brewing unit (A5) by sliding it onto the internal support and pin at the bottom, then push the PUSH symbol fully in until it clicks into place.

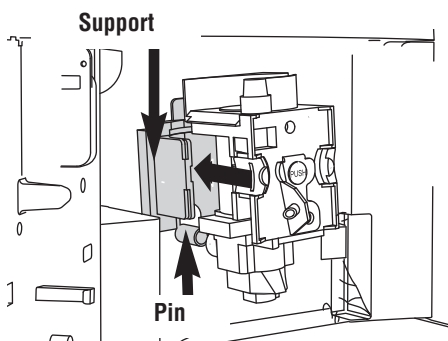

i **N.B.!** If the brewing unit is difficult to insert, you must first adapt it to the right dimensions by pressing it forcefully from the bottom and top as shown in the figure.

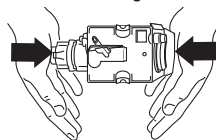

7. Once inserted, make sure the two red buttons have snapped out.

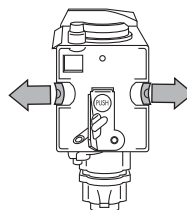

8. Replace the drip tray and waste coffee container.
9. Close the service door.

CHANGING AND SETTING MENU PARAMETERS







When the appliance is ready, you can use the internal menu to modify the following parameters and functions:

- Choose language
- Rinsing
- Shut-off time
- Set clock
- Start time
- Auto-start
- Temperature
- Water hardness
- Program coffee
- Program jug
- Program water
- Descale
- Reset to default
- Statistics
- Install filter
- Reset filter

- Buzzer
- Contrast

Setting the language

To change the language on the display, proceed as follows:





- Press the  icon (B2) to enter the menu. "CHOOSE LANGUAGE" is displayed.
- Press the  icon (B9).
- Press the   icons (B7) and (B8) until the required language is displayed.
- Press the  icon (B9) to confirm.
- Press the  icon (B6) to exit the menu.

 **N.B.!** If you choose the wrong language, you can access the menu directly to modify the parameter.

- Press the  icon button (B2) for at least 7 seconds until the appliance displays the various languages.
- Choose the required language as described in the section "Using the appliance for the first time".

Rinsing









This function enables you to obtain hotter coffee. Proceed as follows:

- When you turn the appliance on, if you want to make a small cup of coffee (less than 60 cc), preheat the cup by rinsing it with hot water.
- If on the other hand more than 2/3 minutes have passed since the last coffee was made, before requesting another coffee, you must preheat the brewing unit by first pressing the  icon (B2) to enter the menu then the   icons (B7) and (B8) to select the "RINSING" function.
Press the  icon (B9). "RINSING... PLEASE CONFIRM" is displayed.
Press the  icon (B9) again.
Deliver the water into the underlying drip tray or alternatively use this water to fill (and then empty) the cup to be used for the coffee to preheat it.











Changing the length of time the appliance remains on

The appliance is set by default to go off automatically 30 minutes after the last coffee has been made.

To change this interval (max. 120 min), proceed as follows:













- Press the  icon (B2) to enter the menu and then the   icons (B7) and (B8) until "SHUT-OFF TIME" is displayed.
- Press the  icon (B9) to confirm.
- Press the   icons (B7) and (B8) to set the time after which the appliance will go off (after 1/2 hour, 1 hour, 2 hours).
- Press the  icon (B9) to confirm.
- Press the  icon (B6) to exit.

Setting the clock









- Press the  icon (B2) to enter the menu and then the   icons (B7) and (B8) until "SET CLOCK" is displayed.
- Press the  icon (B9).
- Use the   icons (B7) and (B8) to set the hour, then press the  icon (B9) to confirm.
- Use the   icons (B7) and (B8) to set the minutes, then press the  icon (B9) to confirm.
- Press the  icon (B6) to exit the menu.

Setting auto-start time

This function programmes the time the machine will come on automatically.









- Make sure the clock on the appliance has been set.
- Press the  icon (B2) to enter the menu and then the   icons (B7) and (B8) until "START TIME" is displayed.
- Press the  icon (B9).
- Use the   icons (B7) and (B8) to set the auto-start time, then press the  icon (B9) to confirm.
- Use the   icons (B7) and (B8) to set the minutes, then press the  icon (B9) to confirm.
- Press the   icons (B7) and (B8) to

activate the auto-start function until "AUTO START" is displayed.

- Press the  icon (B9) to confirm. The  symbol appears on the display.
- Press the  icon (B6) to exit the menu.
- To deactivate the automatic start-up function, press the  (B2) icon, then press the   (B7) and (B8) icons until the appliance displays the message "AUTO ACCENSIONE" (AUTO START-UP). Press the  (B9) icon. "CONFERMARE" (CONFIRM) will appear on the display. Press  to deactivate and the  symbol will disappear.

Changing coffee temperature







To change coffee temperature, proceed as follows:

- Press the  icon (B2) to enter the menu and then the   icons (B7) and (B8) until "TEMPERATURE" is displayed.
- Press the  icon (B9).
- Press the   icons (B7) and (B8) to select the required coffee temperature from low, medium and high.
- Press the  button (B9) to confirm the temperature selected.
- Press the  icon (B6) to exit the menu.

Setting water hardness

The operating period can be extended if required, making descaling less frequent by programming the machine on the basis of the real lime content in the water used.

Proceed as follows:

- remove the "Total Hardness Test" strip (attached to page 2) from its packaging then dip it fully in the water for a few seconds, then remove and wait about 30 seconds (until it changes colour and forms red squares).
- turn the appliance on by pressing the ON/OFF/stand-by button (A7).
- Press the  icon (B2) to enter the menu and then the   icons (B7) and (B8) until "WATER HARDNESS" is displayed.
- Press the  icon (B9).
- Press the   icons (B7) and (B8)

until the number coincides with the number of red squares on the test strip (for example, if there are 3 red squares on the test strip, select the message "WATER HARDNESS 3" .

- Press the  icon (B9) to confirm. The coffee maker is now programmed to provide the descale warning when actually necessary.

Programming coffee

For instructions on programming coffee, see the "CHANGING THE QUANTITY OF COFFEE IN THE CUP" section.

Programming water

For instructions, see the "CHANGING THE QUANTITY OF HOT WATER" section.

Descaling





 **Important!** Descaler contains acids. Respect the safety warnings provided by the manufacturer and given on the descaler pack.

 **N.B.!** Use the descaler recommended by the manufacturer only. Use of other descalers invalidates the guarantee. Failure to descale the appliance as described also invalidates the guarantee.





 **Important!** Before descaling, make sure the water softener filter has been removed.

When "PLEASE DESCALE !" is displayed, the machine requires descaling.

Proceed as follows:

- Make sure the machine is ready;
- Press the  icon (B2) to enter the menu and then the   icons (B7) and (B8) until "DESCALE" is displayed.
- Press the  icon (B9) and the appliance displays "DESCALE PLEASE CONFIRM".
- Press the  icon (B9). The message "ADD DESCALER PLEASE CONFIRM" is displayed.
- Empty the tank of water, pour the contents of the descaler bottle into the tank respecting

the instructions given on the descaler pack, then add water up to the MAX level marked on the water tank. Position a container with a capacity of about 2 litres under the hot water spout.

- Press the  icon (B9). Descaler flows out of the hot water spout into the container below. The appliance displays: "DESCALING".
- The descale programme automatically performs a series of deliveries and pauses.
- After about 30 minutes "DESCALE COMPLETE PLEASE CONFIRM" is displayed.
- Press the  icon (B9). "RINSING PLEASE CONFIRM" is displayed.
- Empty the water tank, rinse to eliminate descaler residues, then fill with clean water.
- Replace the tank full of clean water. "RINSING PLEASE CONFIRM" is displayed again.
- Press the  icon (B9) again. Hot water flows out of the spout into the container below and "RINSING" is displayed.
- Wait until "RINSING COMPLETE PLEASE CONFIRM" is displayed.
- Press the  icon (B9). "DESCALE COMPLETE" is displayed, then "FILL TANK". Fill the tank again with clean water.
- The descale programme is now terminated and the appliance is ready to make coffee again.





NOTE: If descaling is interrupted before completion, the process must be begun again from the beginning.



Important! FAILURE TO DESCALE THE APPLIANCE REGULARLY INVALIDATES THE GUARANTEE.

Resetting default values (reset)

E' possibile ritornare alle impostazioni originali della macchina (anche dopo che l'utente le ha modificate) procedendo nel seguente modo:







- Press the  icon (B2) to enter the menu and then the   icons (B7) and (B8) until "RESET TO DEFAULT" is displayed.
- Press the  icon (B9) and the appliance displays "RESET TO DEFAULT PLEASE CONFIRM".

- press the  button (B9) to reset the default values;

Statistics

This displays statistics relating to the machine.

To display, proceed as follows:







- Press the  icon (B2) to enter the menu and then the   icons (B7) and (B8) until "STATISTICS" is displayed.
- Press the  icon (B9).
- Press the   icons (B7) and (B8) to verify:
 - How many coffees have been made.
 - How many times the machine has been descaled.
 - The total number of litres of water delivered.
- Press the  icon (B6) once to exit the function or twice to exit the menu.

Buzzer

This activates or deactivates the buzzer emitted by the machine each time an icon is pressed or an accessory is inserted/removed.











N.B.! The buzzer is active by default.

- Press the  icon (B2) to enter the menu and then the   icons (B7) and (B8) until "BUZZER" is displayed.
- Press the  icon (B9). "BUZZER PLEASE CONFIRM" is displayed.
- Press the  icon (B6) to disable or the  icon (B9) to enable the buzzer.
- Press the  icon (B6) to exit the menu.

Adjusting contrast

To increase or reduce the contrast of the display, proceed as follows:

- Press the  icon (B2) to enter the menu and then the   icons (B7) and (B8) until "CONTRAST" is displayed.
- Press the  icon (B9).
- Press the   icons (B7) and (B8) until the required display contrast is reached. The progressive bar indicates the level of contrast selected.

- Press the  icon (B9) to confirm.
- Press the  icon (B6) once to exit the function or twice to exit the menu.

Water filter

For instructions on the water softener filter, see the section "INSTALLING THE FILTER".

TURNING THE APPLIANCE OFF

Each time the appliance is turned off, it performs an automatic rinse cycle which cannot be interrupted.



Danger of burns! During rinsing, a little hot water flows from the coffee spouts. Avoid contact with splashes of water.

To turn the appliance off, press the ON/OFF button (A7).

The appliance performs the rinse cycle then goes off.



N.B.! If the appliance is not used for an extended period, place the main switch on the back of the appliance in the 0 position (A23).

TECHNICAL SPECIFICATION

Voltage: 220-240 V~ 50/60 Hz max. 10A

Absorbed power: 1350 W

Pressure: 15 bars

Water tank capacity: 1.8 litres

Size LxHxD: 594 x 455 x 398 mm

Weight: 23/24 kg

 The appliance complies with the following EC directives:

- Low Voltage Directive 2006/95/EC and subsequent amendments;
- EMC Directive 2004/108/EC and subsequent amendments

Materials and accessories coming into contact

with food conform to European regulation (EC) no. 1935/2004.

ELECTRICAL CONNECTION (UK ONLY)

A) If your appliance comes fitted with a plug, it will incorporate a 13 Amp fuse. If it does not fit your socket, the plug should be cut off from the mains lead, and an appropriate plug fitted, as below.

WARNING: Very carefully dispose of the cut off plug after removing the fuse: do not insert in a 13 Amp socket elsewhere in the house as this could cause a shock hazard.

With alternative plugs not incorporating a fuse, the circuit must be protected by a 15 Amp fuse. If the plug is a moulded-on type, the fuse cover must be re-fitted when changing the fuse using a 13 Amp Asta approved fuse to BS 1362. In the event of losing the fuse cover, the plug must NOT be used until a replacement fuse cover can be obtained from your nearest electrical dealer. The colour of the correct replacement fuse cover is that as marked on the base of the plug.

B) If your appliance is not fitted with a plug, please follow the instructions provided below:

WARNING - THIS APPLIANCE MUST BE EARTHED

IMPORTANT

The wires in the mains lead are coloured in accordance with the following code:

Green and yellow:	Earth
Blue:	Neutral
Brown:	Live





As the colours of the wires in the mains lead may not correspond with the coloured markings identifying the terminals in your plug, proceed as follows:

The green and yellow wire must be connected to the terminal in the plug marked with the letter E or the earth symbol  or coloured green or green and yellow.

The blue wire must be connected to the terminal marked with the letter N or coloured black.

The brown wire must be connected to the terminal marked with the letter L or coloured red.

DISPLAYED MESSAGES

DISPLAYED MESSAGE	POSSIBLE CAUSE	REMEDY
FILL TANK	<ul style="list-style-type: none"> The water tank is empty or positioned incorrectly. 	<ul style="list-style-type: none"> Fill the tank with water and/or insert it correctly, pushing it as far as it will go.
GROUND TOO FINE ADJUST MILL AND <i>(alternating with)</i> PRESS OK	<ul style="list-style-type: none"> The grinding is too fine and the coffee is delivered too slowly. The machine cannot make coffee as there is air in the hydraulic circuit Possible cause: the filter has not been installed correctly. 	<ul style="list-style-type: none"> Turn the grinding adjustment knob one click clockwise towards "7". Make sure the filter (A25) is properly installed and that the installation has been carried out correctly.
GROUND TOO FINE ADJUST MILL AND <i>(alternating with)</i> PRESS OK <i>(then)</i> FILL TANK	<ul style="list-style-type: none"> The tank has been removed during delivery. 	<ul style="list-style-type: none"> Insert the tank and press the  icon (B9). "HOT WATER PRESS OK" is displayed. Press the  icon (B9) again. The appliance is once again ready for use.
EMPTY WASTE COFFEE CONTAINER	<ul style="list-style-type: none"> The waste coffee container (A4) is too full or more than 3 days have passed since you last made coffee (this guarantees correct hygiene of the machine). 	<ul style="list-style-type: none"> Empty the waste coffee container and clean, then replace. Important: when removing the drip tray, the waste coffee container MUST be emptied, even if it is not completely full. If this is not done, when you make the next coffees, the waste coffee container may fill up more than expected and clog the machine.
INSERT WASTE COFFEE CONTAINER	<ul style="list-style-type: none"> After cleaning, the waste coffee container has not been replaced. 	<ul style="list-style-type: none"> Open the service door and insert the waste coffee container.

DISPLAYED MESSAGE	POSSIBLE CAUSE	REMEDY
ADD PRE-GROUND COFFEE	<ul style="list-style-type: none"> The "pre-ground coffee" function has been selected without placing any pre-ground coffee in the funnel. The funnel (A21) is blocked. 	<ul style="list-style-type: none"> Extract the appliance and place pre-ground coffee in the funnel. Empty the funnel with the help of a knife as described in the section "Cleaning the pre-ground coffee funnel".
PLEASE DESCALE!	<ul style="list-style-type: none"> The machine must be descaled. 	<ul style="list-style-type: none"> The descaling procedure described in the "Descaling" section needs to be performed as soon as possible.
LESS COFFEE	<ul style="list-style-type: none"> Too much coffee has been used. 	<ul style="list-style-type: none"> Select a milder taste or reduce the quantity of pre-ground coffee, then make the coffee again.
FILL BEAN CONTAINER	<ul style="list-style-type: none"> The coffee beans have run out. 	<ul style="list-style-type: none"> Fill bean container
INSERT BREWING UNIT	<ul style="list-style-type: none"> The brewing unit has not been replaced after cleaning. 	<ul style="list-style-type: none"> Insert the brewing unit as described in the section "Cleaning the brewing unit".
CLOSE DOOR	<ul style="list-style-type: none"> The service door is open 	<ul style="list-style-type: none"> Close the service door.
GENERAL ALARM!	<ul style="list-style-type: none"> The inside of the appliance is very dirty. 	<ul style="list-style-type: none"> Clean the inside of the appliance thoroughly, as described in the section "Cleaning and maintenance". If the message is still displayed after cleaning, contact a customer services.
REPLACE FILTER!	<ul style="list-style-type: none"> The water softener filter (A25) must be replaced. 	<ul style="list-style-type: none"> You must immediately replace the filter following the instructions in the section "Replacing the filter".

TROUBLESHOOTING

Below is a list of some of the possible malfunctions.

If the problem cannot be resolved as described, contact Customer Services.

PROBLEM	POSSIBLE CAUSE	REMEDY
The coffee is not hot	<ul style="list-style-type: none"> • The cups were not pre-heated. • The brewing unit has cooled down because 2/3 minutes have elapsed since the last coffee was made. • The temperature set is too low. 	<ul style="list-style-type: none"> • Warm the cups by rinsing them with hot water. • Before making coffee, preheat the brewing unit by selecting the RINSING function in the menu. • Change the set temperature (see paragraph "Changing coffee temperature").
The coffee is not creamy enough	<ul style="list-style-type: none"> • The coffee is ground too coarsely. • Wrong type of coffee 	<ul style="list-style-type: none"> • Turn the grinding adjustment knob one click anticlockwise towards "1" while the coffee mill is in operation (fig. 11). • Use a type of coffee for espresso coffee makers.
The coffee is delivered too slowly or a drop at a time.	<ul style="list-style-type: none"> • The coffee is ground too finely. 	<ul style="list-style-type: none"> • Turn the grinding adjustment knob one click clockwise towards "7" while the coffee mill is in operation (fig. 11). Continue one click at a time until coffee delivery is satisfactory. The effect is only visible after delivering two coffees.

PROBLEM	POSSIBLE CAUSE	REMEDY
The coffee is delivered too quickly.	<ul style="list-style-type: none"> The coffee is ground too coarsely. 	<ul style="list-style-type: none"> Turn the grinding adjustment knob one click anticlockwise towards "1" while the coffee mill is in operation (fig. 11). Avoid turning the grinding adjustment knob excessively otherwise when you select 2 cups, the coffee may be delivered a drop at a time. The effect is only visible after delivering two coffees.
Coffee does not come out of one of the spouts.	<ul style="list-style-type: none"> The spouts are blocked 	<ul style="list-style-type: none"> Clean the spouts with a toothpick (fig. 23).
The coffee does not come out of the spouts, but from around the service door (A2).	<ul style="list-style-type: none"> The holes in the spouts are clogged with dry coffee dust. The coffee guide (A3) inside the service door is blocked and cannot swing. 	<ul style="list-style-type: none"> If necessary, remove coffee deposits with a toothpick, sponge or stiff bristled kitchen brush (fig. 23). Thoroughly clean the coffee guide (A3), particularly near the hinges.
Water comes out of the spouts instead of coffee	<ul style="list-style-type: none"> The pre-ground coffee may be blocked in the funnel (A21). 	<ul style="list-style-type: none"> Clean the funnel (A21) with a wooden or plastic fork, clean the inside of the machine.