

COOKING LOVERS LOVE PUJADAS

2016

CATÁLOGO TARIFA
CATALOGUE PRICE LIST
CATALOGUE TARIF
KATALOGTARIF

pujadas®

A VOLLRATH® COMPANY

PROFESSIONAL COOKWARE

pujadas[®]

A VOLLRATH[®] COMPANY

PROFESSIONAL COOKWARE

Ctra. de Castanyet, 132 - P.O.Box 121
17430 Santa Coloma de Farners
(GIRONA) - SPAIN

Ventas en España

Tel. 972 84 32 01
Fax 972 84 35 27
info@pujadas.es

Export Department

Tel. +34 972 84 32 01
Fax +34 972 84 35 27
info@pujadas.es

www.pujadas.es
info@pujadas.es

ÍNDICE DE PRODUCTOS / PRODUCT INDEX / TABLE DES MATIÈRES / PRODUKTINDEX



1.

COCINA / KITCHEN / CUISINE / KÜCHE

1.1 BATERÍA DE COCINA / COOKWARE / BATTERIE DE CUISINE / KOCHBEDARF	14
1.2 SARTENES / FRY PANS / POÊLES / PFANNEN	38
1.3 HORNO Y RUSTIDERAS / OVEN AND ROAST PAN / FOUR ET PLAQUES À RÔTIR / OFEN- UND BRATFORMEN	50
1.4 ACCESORIOS DE COCINA / KITCHEN ACCESSORIES / ACCESSOIRES DE CUISINE / KÜCHENZUBEHÖR	58



2.

BATERÍA COCINA FOODIES / FOODIES COOKWARE / BATTERIE CUISINE FOODIES / FOODIES KOCHBEDARF

2.1 PUJADAS 1921	92
2.2 BLACK SERIES	94
2.3 MULTIMETAL	98
2.4 COOL • LINE	100
2.5 IDEA	102
2.6 HOBBY CHEF	104
2.7 APARTAMENTO	106
UTENSILIOS DE COCINA / KITCHEN UTENSILS / USTENSILES DE CUISINE / KÜCHENUTENSILIEN	107



3.

TRANSPORTE Y ALMACENAMIENTO / TRANSPORT AND STORAGE / TRANSPORT ET STOCKAGE / TRANSPORT UND LAGERUNG

3.1 CUBETAS GASTRONORM / GASTRONORM CONTAINERS / BACS GASTRONORME / GASTRONORM BEHÄLTER	116
3.2 CESTAS PARA VAJILLA / DISHWASHER RACKS / CASIERS À VAISSELLE / SPÜLMASCHINENKÖRBE	136
3.3 CARROS / TROLLEYS / CHARIOTS / SERVIERWAGEN	148
3.4 ESTANTERÍAS / SHELVING / ÉTAGÈRES / REGALE	168



4.

MAQUINARIA / MACHINERY / MACHINES / MASCHINEN

-
- 4.1 MANTECADORAS HELADO /
ICE-CREAM MAKERS /
TURBINES À GLACE /
EISMASCHINEN** 188
-
- 4.2 PROCESADOR ALIMENTOS /
FOOD PROCESSORS /
ROBOTS MULTIFONCTION /
LEBENSMITTELMASCHINEN** 193
-
- 4.3 BRAZOS TRITURADORES /
IMMERSION BLENDERS /
MIXEURS /
STABMIXER** 196
-
- 4.4 BATIDORAS /
BLENDERS /
MIXEURS /
MIXER** 199
-
- 4.5 FREIDORAS /
FRYERS /
FRITEUSES /
FRITEUSEN** 211
-
- 4.6 TOSTADORAS /
TOASTERS /
TOASTEURS /
TOASTER** 213
-
- 4.7 GRILL DE CONTACTO Y PLANCHAS ELÉCTRICAS /
CONTACT GRILL AND ELECTRIC GRIDDLES /
GRILL DE CONTACT ET PLAQUES ÉLECTRIQUES /
KONTAKTGRILL UND ELEKTRISCHE** 217
-
- 4.8 GRILLS
PLACAS INDUCCIÓN /
INDUCTION HOBBS /
PLAQUES INDUCTION /
INDUKTIONSKOCHFELDER** 221
-
- 4.9 HORNOS Y MICRO-ONDAS /
OVENS & MICRO-WAVES /
FOURS ET MICRO-ONDES /
OFEN UND MIKROWELLEN** 223
-
- 4.10 MAQUINARIA MANTENEDORA DE TEMPERATURA /
MACHINERY FOR KEEPING TEMPERATURE /
APPAREILS DE MAINIEN EN TEMPÉRATURE /
WARMHALTEMASCHINEN** 225
-



5.

SERVICIO DE MESA Y BUFFET / TABLE AND BUFFET SERVICE / SERVICE DE TABLE ET BUFFET / TISCH- UND BUFFET- SERVICE

-
- 5.1 BUFFET Y PRESENTACIÓN /
BUFFET AND PRESENTATION /
BUFFET ET PRÉSENTATION /
BUFFET UND PRÄSENTATION** 236
-
- 5.2 BAR** 312
-
- 5.3 SERVICIO DE MESA /
TABLE TOP SERVICE /
SERVICE DE TABLE /
TISCHSERVICE** 328
-
- 5.4 COLECTIVIDADES /
INSTITUTIONS /
COLLECTIVITÉS /
KOLLEKTIVITÄT** 352
-



6.

PASTELERÍA / PASTRY / PÂTISSERIE / PATISSERIE

-
- 6.1 UTENSILIOS DE PASTELERÍA /
PASTRY UTENSILS /
USTENSILES DE PÂTISSERIE /
PATISSERIEZUBEHÖR** 364
-
- 6.2 HELADERÍA /
ICE-CREAM UTENSILS /
UTENSILES POUR GLACE /
ZUBEHÖR FÜR EISCREME** 376
-
- 6.3 MOLDES ANTIADHERENTES /
NON-STICK MOULDS /
MOULES ANTI-ADHÉSIFS /
ANTIHAFT BACKFORMEN** 378
-
- 6.4 CORTAPASTAS /
PASTRY CUTTER /
DÉCOUPOIRS /
TEIGSCHNEIDER** 384
-
- 6.5 MOLDES ACERO INOXIDABLE /
ST/STEEL PASTRY MOULDS /
MOULES EN ACIER INOX /
BACKFORMEN ROSTF. STAHL** 385
-
- 6.6 MANGAS Y BOQUILLAS /
BAGS AND TUBES /
POCHES ET DOUILLES /
SPRITZBEUTEL UND TÜLLEN** 389
-
- 6.7 MOLDES SILICONA /
SILICONE MOULDS /
MOULES SILICONE /
SILIKONBACKFORMEN** 395
-
- 6.8 MOLDES FLEXIPAN /
FLEXIPAN MOULDS /
MOULES FLEXIPAN /
FLEXIPANBACKFORMEN** 403
-

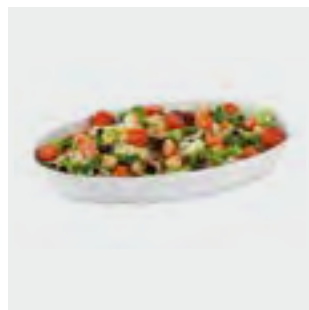
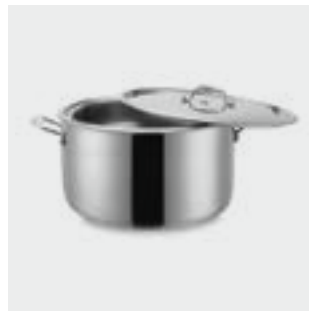
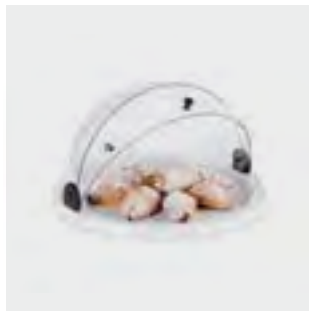
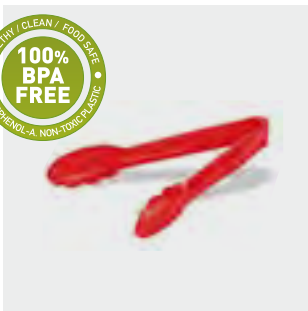

NUEVO/ NEW/ NOUVEAU/ NEUHEITEN



.....
Manopla silicona con funda algodón /
Silicone oven glove with cotton cover /
Gant silicone à fourreau coton /
Silikonhandschuh mit Baumwollfutter

P. 87



.....
Pujadas 1921
Paellera sin tapa /
Paella pan without lid /
Plat à paella sans couvercle /
Paellapfanne ohne Deckel

P. 93



.....
Rustidera ovalada con tapa vidrio /
Oval dish with glass lid /
Cocotte avec couvercle /
Co-cotte mit Deckel

P. 94, 96



.....
Parrilla plana con asas /
Hot-plate with handles /
Grill plat avec poignées /
Flache Bratplatte mit Griffen

P. 97



.....
MULTIMETAL
Rustidera /
Roast pan /
Plaque à rôtir /
Bräter

P. 99



.....
COOL · LINE
Batería de cocina /
Cookware /
Batterie cuisine /
Kochbedarf

P. 100, 101



.....
Cesta para almacenar cubiertos /
Basket for cutlery storage /
Panier pour rangement couverts /
Besteckkorb

P. 142



.....
Carro buffet 4 1/1 GN caliente /
Buffet trolley 4 1/1 GN hot /
Chariot buffet 4 1/1 GN chaud /
Buffetwagen (warm) 4 1/1 GN

P. 149



.....
Carro porta-cubiertos /
Cutlery dispenser trolley /
Chariot porte couverts /
Transportwagen für besteck

P. 151



.....
 Porta-cubiertos /
 Cutlery bin /
 Ramasse-couverts /
 Besteckbehälter

P. 151



.....
 Carro guerdón melamina roble /
 Oak melamine guerdon trolley /
 Chariot guéridon mélamine roure /
 Servierwagen aus eiche melamine

P. 151



.....
 Mantecadoras /
 Ice-cream makers /
 Turbines à glace /
 Eismaschinen

P. 188-190



.....
FRIX'AIR
 Emulsionador y procesador de alimentos /
 Food emulsifier and processor /
 Émulsionneur et processeur d'aliments /
 Emulgator und Küchenmaschine

P. 191



.....
 Molinillo profesional /
 Professional grinder /
 Moulin professionnel /
 Professionelle Mühle

P. 210



.....
 Máquina profesional para hacer conos
 de galleta /
 Professional machine for making
 waffle cones /
 Machine professionnelle pour faire
 des cônes en biscuit /
 Gewerbliche Maschine zur Herstel-
 lung von Waffeltüten

P. 227



.....
CUBIC
 Bandejas presentación pinchos /
 Skewer serving trays /
 Plateaux présentation piques /
 Servierplatten für Spiesschen

P. 244, 245



.....
CUBIC
 Bandeja porta-cubiertos /
 Cutlery-holder tray /
 Plateau porte-couverts /
 Beteckbehälter

P. 252



.....
 Pinza buffet BPA Free color /
 Coloured BPA Free utility tong /
 Pince buffet BPA Free couleur /
 Farbige BPA Free buffetzangen

P. 270



.....
 Vitrinas /
 Display cabinets /
 Vitrines /
 Auslagevitrine

P. 263



.....
 Baño maría especial servicio buffet /
 Special bain marie buffet service /
 Bain-marie spécial service buffet /
 Wasserbad speziell für buffetservice

P. 274, 275



.....
 Dispensador de pan /
 Bread dispenser /
 Présentoir à pain /
 Brotbehälter

P. 284



.....
 Melamina. Bandeja presentación roble /
 Melamine. Oak serving tray /
 Mélamine. Plateau présentation bois /
 Melamin. Eichentablett

P. 291



.....
 Melamina. Pala horno pizarra /
 Melamine. Slate oven peel /
 Mélamine. Pelle four ardoise /
 Melamin. Ofenschieber, Schiefer

P. 292



.....
 Melamina. Fuente oval /
 Melamine. Oval serving dish /
 Mélamine. Plat ovale /
 Melamin. Ovale Buffetschale

P. 304



.....
 Mantel individuales /
 Place mats /
 Sets de table /
 Platzmatten

P. 328, 329



.....
 Melamina. Mini cacerola con tapa.
 Colores /
 Melamine. Mini round casserole with
 lid. Colours /
 Mélamine. Mini cocotte avec couver-
 cle. Couleurs /
 Melamin. Minikasserolle mit Deckel.
 Farben

P. 332



.....
 Aluminio fundición. Mini cacerola sin
 tapa /
 Cast aluminium. Mini round casserole
 without lid /
 Fonte d'aluminium. Mini cocotte sans
 couvercle /
 Aluminiumguss. Minikasserolle ohne
 Deckel

P. 332



COOK, ENJOY, TRY,

NACIMOS EN MANLLEU Y YA DISTRIBUÍMOS NUESTROS PRODUCTOS POR MÁS DE OCHENTA PAÍSES. ADEMÁS, Y DESDE HACE MUY POCO TIEMPO, SOMOS UNA COMPAÑÍA DEL GRUPO VOLLRATH. ASÍ QUE PODEMOS DECIR SIN MIEDO A EQUIVOCARNOS, QUE HOY **PUJADAS ESTÁ EN TODO EL MUNDO.**

FABRICAMOS, COMPRAMOS Y EXPORTAMOS. ESTAMOS CADA VEZ MÁS **CERCA DE LOS MEJORES COCINEROS** DE AQUÍ Y DE ALLÁ, PARA DARLES RESPUESTA EN SUS COCINAS PROFESIONALES Y EN SUS CASAS.

CADA DÍA SOMOS MÁS Y QUEREMOS SEGUIR ACOMPAÑANDO A LOS AMANTES DE LA GASTRONOMÍA, PROFESIONALES Y FOODIES, CON NUESTRAS **PIEZAS DE REFERENCIA.** PUJADAS Y VOLLRATH TRABAJAMOS JUNTOS, APORTANDO EXPERIENCIA, ESFUERZO Y PASIÓN A CADA UNO DE NUESTROS PRODUCTOS Y DE NUESTROS EMPRENDIMIENTOS.

¡LARGA VIDA A LA BUENA COCINA!

WE STARTED IN MANLLEU AND WE NOW DISTRIBUTE OUR PRODUCTS TO MORE THAN EIGHTY COUNTRIES. IN ADDITION, WE HAVE RECENTLY BECOME ONE OF THE VOLLRATH GROUP OF COMPANIES. SO WE CAN SAY, WITHOUT FEAR OF CONTRADICTION, THAT TODAY **PUJADAS IS WORLDWIDE.**

WE MANUFACTURE, BUY AND EXPORT. WE ARE ALWAYS WORKING EVER **CLOSER WITH THE BEST CHEFS,** FROM HERE AND ELSEWHERE, TO MEET THEIR NEEDS IN BOTH THEIR PROFESSIONAL KITCHENS AND IN THEIR HOMES.

EVERYDAY, MORE AND MORE, WE SHARE OUR **BENCHMARK PRODUCTS** WITH LOVERS OF GASTRONOMY, PROFESSIONALS AND FOODIES, AND WE WISH TO CONTINUE DOING SO. PUJADAS AND VOLLRATH WORK TOGETHER, BRINGING EXPERTISE, EFFORT AND PASSION TO EACH OF OUR PRODUCTS AND VENTURES.

LONG LIVE GOOD COOKING!





LIVE WITH PUJADAS

NOUS SOMMES NÉS À MANLLEU ET NOS PRODUITS ÉTAIENT DÉJÀ DISTRIBUÉS DANS PLUS DE QUATRE-VINGTS PAYS. DE PLUS, NOUS SOMMES DEPUIS PEU UNE SOCIÉTÉ DU GROUPE VOLLRATH. NOUS POUVONS DONC AVANCER SANS ÉQUIVOQUE QU'AUJOURD'HUI **PUJADAS EST DANS LE MONDE ENTIER.**

NOUS FABRIQUONS, ACHETONS ET EXPORTONS. NOUS SOMMES DE PLUS EN PLUS **PROCHES DES MEILLEURS CUISINIERS** D'ICI ET D'AILLEURS POUR OFFRIR UNE RÉPONSE À LEURS CUISINES PROFESSIONNELLES ET LEURS CHEZ EUX.

NOUS SOMMES DE PLUS EN PLUS PRÉSENTS ET SOUHAITONS ACCOMPAGNER ENCORE ET TOUJOURS LES PASSIONNÉS DE GASTRONOMIE, LES PROFESSIONNELS ET LES FOODIES AVEC NOS **PIÈCES DE RÉFÉRENCE.** PUJADAS ET VOLLRATH TRAVAILLENT ENSEMBLE EN OFFRANT EXPÉRIENCE, EFFORT ET PASSION À CHACUN DE NOS PRODUITS ET PROJETS.

LONGUE VIE À LA BONNE CUISINE!

WIR BEGANNEN IN MANLLEU UND VERSENDEN JETZT UNSERE PRODUKTE SCHON IN ÜBER ACHTZIG LÄNDER. DARÜBERHINAUS, SIND WIR SEIT KURZEM EIN UNTERNEHMEN DER VOLLRATH GRUPPE. AUS DIESEM GRUNDE KÖNNEN WIR MIT RECHT BEHAUPTEN, **PUJADAS IST JETZT IN DER GANZEN WELT.**

WIR PRODUZIEREN, KAUFEN UND EXPORTIEREN. WIR HABEN EIN IMMER ENGERES VERHÄLTNISS MIT DEN **BESTEN KÖCHEN.** HIER UND DORT, UM IHNEN DIE LÖSUNGEN FÜR IHRE PROFESSIONELLEN KÜCHEN UND ZUHAUSE ANZUBIETEN.

JEDEN TAG WERDEN WIR MEHR, UND WIR WOLLEN WEITERHIN DEN LIEBHABERN DER GASTRONOMIE, BERUFSBEDINGT ODER ALS FOODIES, MIT UNSEREN **VORZEIGESTÜCKEN,** ZUR SEITE STEHEN. PUJADAS UND VOLLRATH ARBEITEN ZUSAMMEN, UND STEUERN ERFAHRUNG, EINSATZ UND LEIDENSCHAFT ZU JEDEM UNSERER PRODUKTE UND ZU UNSEREM UNTERNEHMENSGEIST BEI.

EIN LANGES LEBEN DER GUTEN KÜCHE!





1.1 BATERÍA DE COCINA / COOKWARE / BATTERIE DE CUISINE / KOCHBEDARF 14

TOP LINE	16
INOX-PRO	22
HANDY	30
ALU-PRO	32

1.2 SARTENES / FRY PANS / POÊLES / PFANNEN 38













SARTENES ALUMINIO / ALUMINIUM FRY PANS / POÊLES ALUMINIUM / BRATPFANNEN ALUMINIUM	42
SARTENES ALUMINIO INDUCCIÓN / INDUCTION ALUMINIUM FRY PANS / POÊLES ALUMINIUM INDUCTION / INDUKTION BRATPFANNEN ALUMINIUM	44
SARTENES ACERO INOXIDABLE / ST/STEEL FRY PANS / POÊLES ACIER INOXYDABLE / BRATPFANNEN EDELSTAHL	45
SARTENES ACERO / STEEL FRY PANS / POÊLES ACIER / BRATPFANNEN ROSTFREIER STAHL	47
PAELLERAS / SPANISH PAELLA PAN / PLAT À PAELLA / PAELLAPFANNEN	48

1.3 HORNO Y RUSTIDERAS / OVEN AND ROAST PAN / FOUR ET PLAQUES À RÔTIR / OFEN- UND BRATFORMEN 50

RUSTIDERAS / ROAST PANS / PLAQUES À RÔTIR / BRÄTER	51
BANDEJAS GASTRONORM / GASTRONORM TRAYS / PLAQUES GASTRONORME / GASTRONOMTABLETS	52
BANDEJAS PASTELERÍA / PASTRY TRAYS / PLAQUES À PÂTISSERIE / PATISSERIETABLETT	52
REJILLAS / GRIDS / GRILLES / ROST	54
BANDEJAS PIZZERIA / PIZZERIA TRAYS / PLAQUES À PIZZERIA / PIZZABACKBLECHE	55
ACCESORIOS HORNO / OVEN ACCESSORIES / ACCESSOIRES FOUR / OFENACCESSORIES	56

1.4 ACCESORIOS DE COCINA / KITCHEN ACCESSORIES / ACCESSOIRES DE CUISINE/ KÜCHENZUBEHÖR 58

UTENSILIOS DE COCINA / KITCHEN UTENSILS / USTENSILES DE CUISINE / KÜCHENUTENSILIEN	58
TABLAS DE CORTE / CUTTING BOARDS / PLANCHES À DÉCOUPER / SCHNEIDBRETTER	79
ELEMENTOS DE MEDIDA / MEASURING UTENSILS / USTENSILES DE MESURE / MESSUTENSILIEN	82
PROTECCIÓN TÉRMICA / HEAT PROTECTION / PROTECTION TÉRMIQUE / HITZESCHUTZ	86

	PROFESIONAL / PROFESSIONAL / PROFESSIONNEL / PROFESSIONELL				FOODIES
	TOP LINE	INOX-PRO	HANDY	ALU-PRO	PUJADAS 1921
REF / ITEM / CODE / ART.NR.					
COMPATIBLE CON / COMPATIBLE WITH / COMPATIBLE AVEC / GEEIGNET FÜR					
PRECIO / PRICE / PRIX / PREIS	€€€€	€€€€	€€	€	€€
GARANTÍA AÑOS / WARRANTY YEARS / GARANTIE ANNÉES / GARANTIE JAHRE	5	5	1	1	2
CERTIFICACIÓN / CERTIFICATION / CERTIFICATION / ZERTIFIKATION					
ASAS / HANDLES / ANSES / GRIFFE	AISLANTES / INSULATION / ISOLANTES / ISOLIERUNG	VARILLA / WIRE / FILS / DRAHT	TUBULAR / TUBULAR / TUBULAIRE / TUBULÄR	TUBULAR / TUBULAR / TUBULAIRE / TUBULÄR	TUBULAR / TUBULAR / TUBULAIRE / TUBULÄR
RESTAURANTE / RESTAURANT / RESTAURANT / RESTAURANT	GASTRONÓMICO / GASTRONOMIC / GASTRONOMIQUE / GASTRONOMIE	TODO TIPO / ANY KIND / TOUST YPOS / ALLE TYPEN	MEDIO / MEDIUM / MOYEN / MITTEL	TRADICIONAL / TRADITIONAL / TRADITIONNEL / TRADITIONELL	RÁPIDA Y CON POCO ACEITE / FAST AND LITTLE OIL / RAPIDE ET AVEC PEU D'HUILE / SCHNELL UND MIT WENIG ÖL
MEDIDAS Ø / MEASURES Ø / MESURES Ø / MASSE Ø	12-60	12-70	16-40	16-60	20-32

BLACK SERIES	MULTIMETAL	COOL • LINE	IDEA	HOBBY CHEF	APARTAMENTO
					
					
€€	€€€€€	€€€	€€€	€€€	€
2	5	4	3	4	2
					
INTEGRADO / INTEGRATED / INTÉGRÉ / INTEGRIERT	TUBULAR / TUBULAR / TUBULAIRE / TUBULÄR	FUNDICIÓN / CAST / FONTE / GUSSEISEN	DISEÑO / DESIGN / DESIGN / DESIGN	VARILLA / WIRE / FILS / DRAHT	BAQUELITA / BAKELITE / BAKÉLITE / BAKELITE
TRADICIONAL Y PRESENTACIÓN / TRADITIONAL AND PRESENTATION / TRADITIONNEL ET PRESENTATION / TRADITIONELL UND PRÄSENTATION	GASTRONÓMICO / GASTRONOMIC / GASTRONOMIQUE / GASTRONOMIE	GOURMET	MODERNA / MODERN / MODERNE / MODERN	GOURMET	LIGERA / LIGHT / LÉGERE / LEICHT
16-40	16-36	16-32	12-32	12-32	14-28

TOP LINE

LA BATERÍA MÁS EXCLUSIVA PARA LA ALTA COCINA /
THE MOST EXCLUSIVE COOKWARE LEAD TO HIGH CUISINE /
LA PLUS EXCLUSIVE BATTERIE POUR LA HAUTE CUISINE /
EXCLUSIVSTER KOCHBEDARF FÜR DIE GEHOBENE KÜCHE

CUERPO EN ACERO INOXIDABLE 18/10 /
COOKWARE BODY MADE OF 18/10 STAINLESS STEEL /
CORPS EN ACIER INOXYDABLE 18/10 /
KOCHEBEDARF AUS EDELSTAHL 18/10



INDUCTION

FACILIDAD: ETIQUETAS IDENTIFICATIVAS DE FÁCIL EXTRACCIÓN /
EASY: IDENTIFICATION STICKER EASY TO REMOVE /
FACILE : ETIQUETTES IDENTIFICATRICES FACILES À ENLEVER /
EINFACH: IDENTIFIZIERUNGSETIKETTEN LEICHT ZU ENTFERNEN

VERTIDO FÁCIL /
EASY POURING /
VERCEMENT FACILE /
SCHÜTTRAND

ESTÉTICA: ACABADO SATINADO /
AESTHETICS: SATIN FINISH /
ESTHÉTIQUE : FINITION SATINÉE /
ÄSTHETIK: SATINIERTER AUSFÜHRUNG

CALIDAD: SATINADO UNIFORME EN TODOS LOS MODELOS /
QUALITY: UNIFORM SATIN POLISHING IN ALL MODELS /
QUALITÉ : POLISSAGE SATINÉ UNIFORME SUR TOUS LES MODÈLES /
QUALITÄT: EINHEITLICH MATT GLÄNZEND FÜR ALLE MODELLE



INDUC



GAS



VITRO



ELECTR





EFICIENTE: TAPAS DISEÑADAS PARA EL AHORRO DE ENERGÍA /
EFFICIENT: LIDS DESIGNED TO SAVE ENERGY /
EFFICIENT : COUVERCLES CONÇUS POUR ÉCONOMISER DE L'ENERGIE /
EFFIZIENZ: ENERGIESPARENDES DECKELDESIGN

AISLANTE: ASAS DE INOX RESISTENTES AL CALOR /
INSULATING: ST/STEEL HEAT RESISTANT HANDLES /
ISOLANT : ANSES EN ACIER INOXYDABLE RÉSISTANTES À LA CHALEUR /
ISOLIERUNG: HITZEBSTÄNDIGE GRIFFE AUS EDELSTAHL

INDUCCIÓN: FONDO SANDWICH (INOX - ALU - INOX) /
INDUCTION: SANDWICH BOTTOM (ST/STEEL - ALU - ST/STEEL) /
INDUCTION : FOND SANDWICH (INOX - ALU - INOX) /
INDUKTION: SANDWICHBODEN (EDELSTAHL-ALUMINIUM - EDELSTAHL)

CONTROL: SOLDADURA ARTESANAL E INSPECCIÓN EN CADA UNIDAD /
CONTROL: HANDCRAFTED WELDING AND CHECKING EVERY UNIT /
CONTRÔLE : SOUDURE ARTISANALE ET VERIFICATION DE CHAQUE UNITÉ /
KONTROLLE: HANDANGESCHWEISST UND ÜBERPRÜFUNG JEDER EINHEIT

EFICACIA / EFFICACY /
EFFICACITÉ / EFFIZIENZ



FRÍO / COLD / FROID / KÄLTE

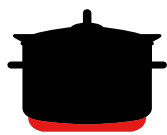

CALIENTE / WARM / CHAUD / HITZE

EFICIENCIA / EFFICACY /
EFFICACITÉ / EFFIZIENZ

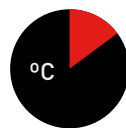

ACERO / INOX-ST/STEEL / EDELSTAHL

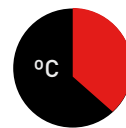

ALUMINIO / ALUMINIUM / ALUMINIUM

TOP LINE

2901

Olla recta sin tapa / Stock pot without lid / Marmite traiteur sans couvercle / Hoher Kochtopf ohne Deckel

CLASS
INDUCTION

REF	Ø cm	H cm	Lts	€	U
290.116	16	16,0	3,00	39,00	1
290.120	20	20,0	6,20	48,95	1
290.124	24	24,0	10,00	61,80	1
290.128	28	28,0	16,50	89,15	1
290.130	30	30,0	21,20	119,55	1
290.132	32	32,0	24,00	126,15	1
290.135	35	35,0	33,60	156,35	1
290.140	40	40,0	50,00	183,70	1
290.145	45	45,0	72,00	224,10	1
290.150	50	50,0	98,00	390,80	1
290.160	60	55,0	155,00	555,30	1

2911

Cacerola baja sin tapa / Casserole without lid / Faitout sans couvercle / Flache Kasserolle ohne Deckel

CLASS
INDUCTION

REF	Ø cm	H cm	Lts	€	U
291.116	16	7,5	1,50	33,85	1
291.120	20	8,0	2,50	38,80	1
291.124	24	9,5	4,30	45,20	1
291.128	28	11,0	6,70	61,40	1
291.130	30	12,0	8,40	83,10	1
291.132	32	12,5	10,00	86,00	1
291.135	35	14,0	13,60	111,85	1
291.140	40	15,5	19,50	135,55	1
291.145	45	17,0	27,00	155,20	1
291.150	50	20,0	39,00	213,90	1
291.160	60	23,0	65,00	308,50	1

2921

Cacerola alta sin tapa / Sauce pot without lid / Braisière sans couvercle / Hohe Kasserolle ohne Deckel

CLASS
INDUCTION

REF	Ø cm	H cm	Lts	€	U
292.116	16	11,0	2,10	36,05	1
292.120	20	13,0	4,00	41,75	1
292.124	24	14,0	6,30	47,50	1
292.128	28	17,5	10,20	64,75	1
292.130	30	18,0	12,70	86,30	1
292.132	32	19,0	15,20	89,85	1
292.135	35	21,0	20,20	122,10	1
292.140	40	25,0	31,40	150,25	1
292.145	45	28,0	44,50	177,50	1
292.150	50	30,0	59,00	231,40	1
292.160	60	35,0	99,00	365,05	1

2931

Paellera sin tapa / Paella pan without lid / Plat à paella sans couvercle / Paellapfanne ohne Deckel

CLASS
INDUCTION

REF	Ø cm	H cm	Lts	€	U
293.124	24	6,0	2,70	40,75	1
293.128	28	6,0	3,70	54,50	1
293.130	30	6,0	4,30	59,80	1
293.132	32	6,0	4,70	72,75	1
293.135	35	7,0	6,70	92,10	1
293.140	40	8,0	10,00	110,65	1
293.145	45	9,0	17,50	127,45	1
293.150	50	10,0	28,00	169,70	1

290 Olla recta con tapa / Stock pot with lid / Marmite traiteur avec couvercle / Hoher Kochtopf mit Deckel



REF	Ø cm	H cm	Lts	€	U
290.016	16	16,0	3,00	45,40	1
290.020	20	20,0	6,20	57,85	1
290.024	24	24,0	10,00	71,25	1
290.028	28	28,0	16,50	101,20	1
290.030	30	30,0	21,20	134,15	1
290.032	32	32,0	24,00	142,15	1
290.035	35	35,0	33,60	171,45	1
290.040	40	40,0	50,00	205,90	1
290.045	45	45,0	72,00	257,05	1
290.050	50	50,0	98,00	410,35	1
290.060	60	55,0	155,00	570,70	1

291 Cacerola baja con tapa / Casserole with lid / Faitout avec couvercle / Flache Kasserolle mit Deckel



REF	Ø cm	H cm	Lts	€	U
291.016	16	7,5	1,50	39,70	1
291.020	20	8,0	2,50	47,60	1
291.024	24	9,5	4,30	54,60	1
291.028	28	11,0	6,70	76,70	1
291.030	30	12,0	8,40	95,05	1
291.032	32	12,5	10,00	95,85	1
291.035	35	14,0	13,60	128,55	1
291.040	40	15,5	19,50	147,90	1
291.045	45	17,0	27,00	169,50	1
291.050	50	20,0	39,00	236,45	1
291.060	60	23,0	65,00	339,30	1

292 Cacerola alta con tapa / Sauce pot with lid / Braisière avec couvercle / Hohe Kasserolle mit Deckel



REF	Ø cm	H cm	Lts	€	U
292.016	16	11,0	2,10	42,85	1
292.020	20	13,0	4,00	51,65	1
292.024	24	14,0	6,30	60,50	1
292.028	28	17,5	10,20	81,05	1
292.030	30	18,0	12,70	100,90	1
292.032	32	19,0	15,20	103,25	1
292.035	35	21,0	20,20	139,10	1
292.040	40	25,0	31,40	174,15	1
292.045	45	28,0	44,50	195,95	1
292.050	50	30,0	59,00	267,40	1
292.060	60	35,0	99,00	390,80	1

293 Paellera con tapa / Paella pan with lid / Plat à paella avec couvercle / Paellapfanne mit Deckel



REF	Ø cm	H cm	Lts	€	U
293.024	24	6,0	2,70	50,95	1
293.028	28	6,0	3,70	70,90	1
293.030	30	6,0	4,30	77,90	1
293.032	32	6,0	4,70	90,70	1
293.035	35	7,0	6,70	114,30	1
293.040	40	8,0	10,00	131,80	1
293.045	45	9,0	17,50	152,70	1
293.050	50	10,0	28,00	197,45	1

201 Cazo recto bajo / Saucepan / Casserole / Flache Stielkasserolle

**CLASS
INDUCTION**



REF	Ø cm	H cm	Lts	€	U
201.016	16	7,5	1,50	26,85	1
201.018	18	8,0	2,00	27,75	1
201.020	20	8,0	2,50	31,20	1
201.024	24	9,5	4,30	36,05	1
201.028	28	11,0	6,70	52,40	1
201.032	32*	12,5	10,00	78,70	1

* Con contraasa / With counterhandle /
Avec contre anse / mit Zusatzgriff

202 Cazo recto alto / Deep saucepan / Casserole haute / Hohe Stielkasserolle

**CLASS
INDUCTION**



REF	Ø cm	H cm	Lts	€	U
202.016	16	11,0	2,10	27,25	1
202.018	18	12,0	3,00	32,20	1
202.020	20	13,0	4,00	36,70	1
202.024	24	14,0	6,30	43,45	1
202.028	28	17,5	10,20	61,40	1
202.032	32*	19,0	15,20	83,20	1

* Con contraasa / With counterhandle /
Avec contre anse / Mit Zusatzgriff

200 Cazo tipo francés / French style saucepan / Casserole forme française / Französische Kasserolle

**CLASS
INDUCTION**



REF	Ø cm	H cm	Lts	€	U
200.012	12	7,0	0,70	24,40	1
200.014	14	7,0	1,00	26,75	1
200.016	16	7,5	1,50	26,85	1
200.018	18	9,0	2,30	31,30	1
200.020	20	10,0	3,10	35,15	1
200.022	22	11,0	4,20	38,00	1
200.024	24	12,0	5,40	41,95	1
200.028	28	14,0	8,60	58,65	1

La diferencia entre las refs. 200, 201 y 202 es su altura.
The only difference between the refs. 200, 201 and 202 is its height.
La différence entre les réfs. 200, 201 et 202 c'est l'hauteur.
Die Artikel 200, 201 und 202 unterscheiden sich in der Höhe.

214 Cazo cónico / Conical sauté pan / Sauteuse evasée / Konische Kasserolle

**CLASS
INDUCTION**



REF	Ø cm	H cm	Lts	€	U
214.016	16	6,0	1,00	30,40	1
214.018	18	6,0	1,20	33,35	1
214.020	20	6,5	1,60	34,85	1
214.022	22	7,0	2,10	37,70	1
214.024	24	7,5	2,70	41,75	1

2003 Cazo bombeado / Rounded saucepan / Casserole bombée / Kugelige Kasserolle mit Schüttrand

CLASS
INDUCTION



REF	Ø cm	H cm	Lts	€	U
200.320	20	7,5	1,80	31,60	1
200.324	24	8,5	3,00	36,35	1

204 Sautex / Sauté pan / Sauteuse / Sauteuse

CLASS
INDUCTION



REF	Ø cm	H cm	Lts	€	U
204.020	20	6,0	1,90	31,10	1
204.024	24	6,0	2,70	35,55	1
204.028	28	6,0	3,70	50,35	1
204.030	30	6,0	4,30	56,45	1
204.032	32	6,0	4,70	58,95	1
204.035	35	7,0	6,70	83,20	1
204.040	40*	8,0	10,00	94,65	1

* Con contraasa / With counterhandle /
Avec contre anse / Mit Zusatzgriff

299 Tapa / Lid / Couvercle / Deckel



REF	Ø cm	€	U
299.016	16	8,40	1
299.020	20	9,50	1
299.024	24	11,15	1
299.028	28	13,80	1
299.030	30	15,70	1
299.032	32	17,20	1
299.035	35	20,35	1
299.040	40	24,00	1
299.045	45	29,40	1
299.050	50	34,55	1
299.060	60	45,70	1

**COOK,
ENJOY,
TRY,
LIVE
WITH
PUJADAS**



INOX-PRO

DISEÑADA PARA OFRECER EL MAYOR RENDIMIENTO EN LA COCINA PROFESIONAL /
SPECIALLY DESIGNED TO ACHIEVE THE BEST PERFORMANCE IN THE PROFESSIONAL COOKING /
CONÇUE POUR OFFRIR LE PLUS HAUT RENDEMENT DANS LA CUISINE PROFESSIONNELLE /
SPEZIELLES DESIGN FÜR DIE BESTE PERFORMANZ IN DER PROFESSIONELLEN KÜCHE

CUERPO EN ACERO INOXIDABLE 18/10 /
COOKWARE BODY MADE OF 18/10 STAINLESS STEEL /
CORPS EN ACIER INOXYDABLE 18/10 /
KOCHKÖRPER AUS EDELSTAHL 18/10



SEGURA: ASAS SOLDADAS POR APORTACIÓN DE MATERIALES /
SAFETY : WELDED HANDLES BY BUILD-UP PROCESS /
SÉCURITÉ : SOUDURES DES ANSES PAR RÉSTANCE /
SICHERHEIT: ANGESCHWEISSTE GRIFFE FÜR DIE RESISTENZ



SOLIDA Y ROBUSTA: ASAS DE VARILLAS MATIZADA
EN INOX ULTRARESISTENTES, 500 KG /

SOLID AND ROBUST: ST/STEEL WIRE HANDLE
ULTRA-RESISTANT, 500KG /

SOLIDE ET ROBUSTE : ANSES EN FIL INOX
ULTRA-RÉSISTANTES, 500KG /

SOLIDE UND ROBUST: GRIFFE AUS
EDELSTAHL DRAHT, ULTRA RESISTENT,
500KG

EFICIENTE: TAPAS DISEÑADAS PARA EL AHORRO DE ENERGÍA /
EFFICIENT: LIDS DESIGNED TO SAVE ENERGY /
EFFICIENT : COUVERCLES CONÇUS POUR ÉCONOMISER DE L'ÉNERGIE /
EFFIZIENT: ENERGIESPARENDES DECKELDESIGN

ÚNICA: IDENTIFICACIÓN DE ORIGEN Y TIPO FUENTE DE CALOR /
UNIQUE: ORIGIN IDENTIFICATION AND TYPE OF COOKING SYSTEM /
UNIQUE : IDENTIFICATION DE L'ORIGINE ET TYPE DE SYSTEME DE CUISSON /
UNIKAT: HERKUNFTSIDENIFIZIERUNG UND TYP DES KOCHSYSTEMS



INDUC



GAS



VITRO



ELECTR



GARANTÍA: CONTROL DE TODOS LOS PROCESOS DE FABRICACIÓN /
WARRANTY: CONTROL OF ALL PRODUCTION PROCESSES /
GARANTIE : CONTRÔLE DE TOUS LES PROCESSUS DE PRODUCTION /
GARANTIE: KONTROLLE ALLER FABRIKATIONSPROZESSE

CALIDAD: PULIDO SATINADO INTERIOR Y EXTERIOR
UNIFORME EN TODOS LOS MODELOS /

QUALITY: INNER AND OUTER SIDES OF ALL MODELS WITH
UNIFORM SATIN POLISHING /

QUALITÉ : POLISSAGE SATINÉ UNIFORME À L'INTÉRIEUR ET À
L'EXTÉRIEUR DE TOUS LES MODÈLES /

QUALITÄT: SATINIERTER POLIERUNG INNEN UND AUSSEN
EINHEITLICH FÜR ALLE MODELLE

RADIOS INTERIORES DISEÑADOS PARA UNA LIMPIEZA FÁCIL Y RÁPIDA /
RADIUS SPECIALLY DESIGNED FOR EASY AND FAST CLEANING /
RAYONS PERMETTANT UN ENTRETIEN FACILE ET RAPIDE /
INNEN-RADIUS DESIGNT FÜR EINFACHE UND SCHNELLE REINIGUNG



CONTROL: SOLDADURA ARTESANAL E INSPECCIÓN EN CADA UNIDAD /
CONTROL: HANDCRAFTED WELDING AND CHECKING EVERY UNIT /
CONTRÔLE : SOUDURE ARTISANALE ET VERIFICATION DE CHAQUE UNITÉ /
KONTROLLE: HANDANGESCHWEISST UND ÜBERPRÜFUNG JEDER EINHEIT

INDUCCIÓN: FONDO SANDWICH (INOX - ALU - INOX) /
INDUCTION: SANDWICH BOTTOM (ST/STEEL - ALU - ST/STEEL) /
INDUCTION : FOND SANDWICH (INOX - ALU - INOX) /
INDUKTION: SANDWICHBODEN (EDELSTAHL-ALUMINIUM-EDELSATHL)

EFICACIA / EFFICACY /
EFFICACITÉ / EFFIZIENZ

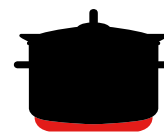

FRÍO / COLD / FROID / KÄLTE CALIENTE / WARM / CHAUD / HITZE

INOX-PRO

218 Olla recta sin tapa / Stock pot without lid / Marmite traiteur sans couvercle / Hoher Kochtopf ohne Deckel**CLASS**
INDUCTION

REF	Ø cm	H cm	Lts	€	U
218.016	16	16,0	3,00	37,80	1
218.018	18	18,0	4,50	46,40	1
218.020	20	20,0	6,20	47,60	1
218.024	24	24,0	10,00	60,20	1
218.028	28	28,0	16,50	86,65	1
218.030	30	30,0	21,20	116,20	1
218.032	32	32,0	24,00	122,40	1
218.035	35	35,0	33,60	151,15	1
218.040	40	40,0	50,00	177,90	1
218.045	45	45,0	72,00	224,10	1
218.050	50	50,0	98,00	371,25	1
218.060	60	55,0	155,00	527,45	1

217 Cacerola baja sin tapa / Casserole without lid / Faitout sans couvercle / Flache Kasserolle ohne Deckel**CLASS**
INDUCTION

REF	Ø cm	H cm	Lts	€	U
217.016	16	7,5	1,50	32,85	1
217.018	18	8,0	2,00	36,90	1
217.020	20	8,0	2,50	37,70	1
217.024	24	9,50	4,30	43,85	1
217.028	28	11,0	6,70	59,55	1
217.030	30	12,0	8,40	80,75	1
217.032	32	12,5	10,00	83,60	1
217.035	35	14,0	13,60	108,70	1
217.040	40	15,5	19,50	131,60	1
217.045	45	17,0	27,00	155,20	1
217.050	50	20,0	39,00	213,90	1
217.060	60	23,0	65,00	308,50	1

216 Cacerola alta sin tapa / Sauce pot without lid / Braisière sans couvercle / Hohe Kasserolle ohne Deckel**CLASS**
INDUCTION

REF	Ø cm	H cm	Lts	€	U
216.016	16	11,0	2,10	35,05	1
216.018	18	12,0	3,00	39,10	1
216.020	20	13,0	4,00	40,65	1
216.024	24	14,0	6,30	46,10	1
216.028	28	17,5	10,20	62,90	1
216.030	30	18,0	12,70	83,90	1
216.032	32	19,0	15,20	87,25	1
216.035	35	21,0	20,20	118,25	1
216.040	40	25,0	31,40	146,00	1
216.045	45	28,0	44,50	177,50	1
216.050	50	30,0	59,00	231,40	1
216.060	60	35,0	99,00	365,05	1

205 Paellera sin tapa / Paella pan without lid / Plat à paella sans couvercle / Paellapfanne ohne Deckel**CLASS**
INDUCTION

REF	Ø cm	H cm	Lts	€	U
205.020	20	6,0	1,90	33,05	1
205.024	24	6,0	2,70	39,60	1
205.028	28	6,0	3,70	52,90	1
205.030	30	6,0	4,30	58,05	1
205.032	32	6,0	4,70	70,60	1
205.035	35	7,0	6,70	89,45	1
205.040	40	8,0	10,00	107,50	1
205.045	45	8,5	12,00	127,45	1
205.050	50	9,0	17,50	169,70	1
205.060	60	10,0	28,00	273,55	1

208 Olla recta con tapa / Stock pot with lid / Marmite traiteur avec couvercle / Hoher Kochtopf mit Deckel

CLASS
INDUCTION



REF	Ø cm	H cm	Lts	€	U
208.016	16	16,0	3,00	44,05	1
208.018	18	18,0	4,50	54,20	1
208.020	20	20,0	6,20	56,15	1
208.024	24	24,0	10,00	69,20	1
208.028	28	28,0	16,50	98,30	1
208.030	30	30,0	21,20	130,30	1
208.032	32	32,0	24,00	138,10	1
208.035	35	35,0	33,60	166,55	1
208.040	40	40,0	50,00	200,10	1
208.045	45	45,0	72,00	257,05	1
208.050	50	50,0	98,00	397,95	1
208.060	60	55,0	155,00	553,60	1

207 Cacerola baja con tapa / Casserole with lid / Faitout avec couvercle / Flache Kasserolle mit Deckel

CLASS
INDUCTION



REF	Ø cm	H cm	Lts	€	U
207.016	16	7,5	1,50	38,60	1
207.018	18	8,0	2,00	44,50	1
207.020	20	8,0	2,50	46,30	1
207.024	24	9,5	4,30	53,00	1
207.028	28	11,0	6,70	72,25	1
207.030	30	12,0	8,40	92,30	1
207.032	32	12,5	10,00	90,25	1
207.035	35	14,0	13,60	124,90	1
207.040	40	15,5	19,50	143,75	1
207.045	45	17,0	27,00	166,15	1
207.050	50	20,0	39,00	231,70	1
207.060	60	23,0	65,00	332,50	1

206 Cacerola alta con tapa / Sauce pot with lid / Braisière avec couvercle / Hohe Kasserolle mit Deckel

CLASS
INDUCTION



REF	Ø cm	H cm	Lts	€	U
206.016	16	11,0	2,10	41,65	1
206.018	18	12,0	3,00	46,80	1
206.020	20	13,0	4,00	50,15	1
206.024	24	14,0	6,30	58,75	1
206.028	28	17,5	10,20	77,10	1
206.030	30	18,0	12,70	96,05	1
206.032	32	19,0	15,20	98,20	1
206.035	35	21,0	20,20	132,10	1
206.040	40	25,0	31,40	165,85	1
206.045	45	28,0	44,50	191,60	1
206.050	50	30,0	59,00	262,00	1
206.060	60	35,0	99,00	382,90	1

215 Paellera con tapa / Paella pan with lid / Plat à paella avec couvercle / Paellapfanne mit Deckel

CLASS
INDUCTION



REF	Ø cm	H cm	Lts	€	U
215.020	20	6,0	1,90	43,45	1
215.024	24	6,0	2,70	49,55	1
215.028	28	6,0	3,70	68,90	1
215.030	30	6,0	4,30	74,75	1
215.032	32	6,0	4,70	88,15	1
215.035	35	7,0	6,70	111,05	1
215.040	40	8,0	10,00	125,55	1
215.045	45	8,5	12,00	149,65	1
215.050	50	9,0	17,50	197,45	1
215.060	60	10,0	28,00	282,25	1

INOX-PRO

240 Conjunto cuscusera bombeada, con tapa / Conical couscous set with lid / Couscoussier bombée avec couvercle / Konisches Couscoustopfset mit Deckel

CLASS
INDUCTION

REF	Ø cm	H cm	Lts	€	U
240.040	A 40	20,0	20,00	228,75	1
	B 32	32,0	24,00		
240.050	A 50	25,0	40,00	328,45	1
	B 40	40,0	50,00		
240.060	A 60	23,5	45,00	886,10	1
	B 45	45,0	72,00		
240.070	A 70	25,0	65,00	962,10	1
	B 50	50,0	98,00		

241 Parte superior de cuscusera bombeada / Top for couscous set conical shape / Dessus seul pour couscoussier forme bombée / Oberteil vom konischen Couscoustopfset



REF	Ø cm	H cm	Lts	€	U
241.040	40	20,0	20,00	83,30	1
241.050	50	25,0	40,00	115,60	1
241.060	60	23,5	45,00	457,75	1
241.070	70	25,0	65,00	528,65	1

Ø agujeros / holes / trous / Löcher 4 mm
Sin tapa / Without lid / Sans couvercle / Ohne Deckel

242 Conjunto cuscusera forma recta / Straight couscous set / Couscoussier forme droite / Couscoustopfset gerade Form

CLASS
INDUCTION

REF	Ø cm	H cm	Lts	€	U
242.020	A 20	13,0	4,00	89,55	1
	B 20	20,0	6,20		
242.024	A 24	14,0	6,30	110,45	1
	B 24	24,0	10,00		
242.028	A 28	17,5	10,00	156,05	1
	B 28	28,0	16,50		
242.032	A 32	19,0	15,00	204,45	1
	B 32	32,0	24,00		
242.035	A 35	21,0	20,00	254,80	1
	B 35	35,0	33,60		

Con tapa / With lid / Avec couvercle / Mit Deckel

243 Parte superior de vaporera y cuscusera / Top for steam pot and couscous set straight shape / Dessus seul pour couscoussier forme droite et cuit vapeur / Oberteil Dampfgarer und Couscoustopf



REF	Ø cm	H cm	Lts	€	U
243.020	20	13,0	4,00	31,80	1
243.024	24	14,0	6,30	40,20	1
243.028	28	17,5	10,00	51,65	1
243.032	32	19,0	15,00	57,75	1
243.035	35	21,0	20,00	74,95	1

Ø agujeros / holes / trous / Löcher 3,25 mm
Sin tapa / Without lid / Sans couvercle / Ohne Deckel

244 Conjunto vaporera / Steam pot / Cuit vapeur / Dampfgarset

CLASS
INDUCTION

REF	Ø cm	H cm	Lts	€	U
244.020	A 20	13,0	4,00	83,50	1
	B 20	13,0	4,00		
244.024	A 24	14,0	6,30	99,70	1
	B 24	14,0	6,30		
244.028	A 28	17,5	10,00	134,35	1
	B 28	17,5	10,00		
244.032	A 32	19,0	15,00	165,15	1
	B 32	19,0	15,00		
244.035	A 35	21,0	20,00	220,65	1
	B 35	21,0	20,00		

Con tapa / With lid / Avec couvercle / Mit Deckel

223 Conjunto cacerola + 4 colapastas / Casserole set + 4 pasta colander /
Ensemble braisière + 4 cuit-pâtes / Kasserolleset + 4 Nudelsiebe

**CLASS
INDUCTION**



REF	Ø cm	H cm	Lts	€	U
223.035	35	21,0	20,20	371,10	1
223.040	40	25,0	31,40	454,00	1

Datos relativos a la cacerola 216.
Casserole data 216.
Caractéristiques afférentes au braisière 216.
Entsprechende Eigenschaften der Kasserolle 216.

Sin tapa / Without lid / Sans couvercle / Ohne Deckel

224 Colapasta / Pasta colander / Cuit-pâtes / Nudelsieb



REF	H cm	€	U
A 224.023	23,0	61,60	1
B 224.026	26,0	75,20	1

A Utilizable para la ref. 216 - Ø 35 cm B Utilizable para la ref. 216 - Ø 40 cm
A It fits ref. 216 - Ø 35 cm B It fits ref. 216 - Ø 40 cm
A Utilisable pour la ref. 216 - Ø 35 cm B Utilisable pour la ref. 216 - Ø 40 cm
A Benutzbar für Art.Nr. 216 - Ø 35 cm B Benutzbar für Art.Nr. 216 - Ø 40 cm

248 Olla con grifo y tapa / Stock pot with tap and lid /
Marmite traiteur avec robinet et couvercle / Topf mit Ablaufhahn und Deckel

**CLASS
INDUCTION**



REF	Ø cm	H cm	Lts	€	U
248.028	28	28,0	16,50	212,75	1
248.032	32	32,0	24,00	252,00	1
248.035	35	35,0	33,60	286,00	1
248.040	40	40,0	50,00	317,20	1
248.045	45	45,0	72,00	435,05	1

249 Separador para olla con grifo / Grid for stock pot with tap /
Grille pour marmite avec robinet / Separierer für Topf mit Ablaufhahn

IDEA!

Perfecto para la esterilización de tarros /
Ideal for sterilizing jars /
Idéal pour la stérilisation des bocaux /
Ideal für die Sterilisierung von Glasbehältern



REF	Ø cm	H cm	€	U
249.028	27,5	5,50	38,00	1
249.032	31,5	5,50	41,15	1
249.035	34,5	5,50	45,00	1
249.040	39,5	5,50	50,75	1
249.045	44,5	5,50	62,40	1

209 Tapa / Lid / Couvercle / Deckel



REF	Ø cm	€	U
209.014	14	8,00	1
209.016	16	8,20	1
209.018	18	9,00	1
209.020	20	9,40	1
209.022	22	10,85	1
209.024	24	11,05	1
209.028	28	13,35	1
209.030	30	15,20	1
209.032	32	17,20	1
209.035	35	20,05	1
209.040	40	23,50	1
209.045	45	28,65	1
209.050	50	33,95	1
209.060	60	45,50	1
209.070	70	102,85	1

INOX-PRO

211 Escurrefritos / Fry colander / Passoire à frites / Frittensieb

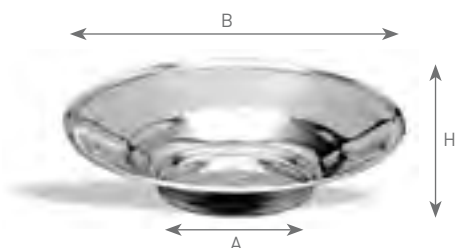

REF	Ø A cm	Ø B cm	H cm	€	U
211.016	16	32,5	7,0	30,30	1
211.018	18	37,5	7,5	34,75	1
211.020	20	38,0	7,5	36,70	1

210 Pote / Pot / Pot / Topf

CLASS
INDUCTION



REF	Ø cm	H cm	Lts	€	U
210.016	16	16,0	3,00	36,05	1
210.018	18	18,0	4,50	40,65	1
210.020	20	20,0	6,20	45,70	1

203 Baño maría / Bain marie / Bain-marie / Wasserbad

CLASS
INDUCTION



REF	Ø cm	H cm	Lts	€	U
203.016	16	16,0	3,00	33,15	1
203.018	18	18,0	4,50	38,10	1
203.020	20	20,0	6,20	41,75	1
203.024	24	24,0	10,00	54,20	1

Con fondo termodifusor tipo sandwich
With diffusing bottom sandwich type
Avec fond thermo diffuseur type sandwich
Mit Thermodiffusionsboden Typ Sandwich

219 Baño maría sin fondo sandwich / Bain marie without sandwich bottom / Bain-marie sans fond sandwich / Wasserbad ohne Sandwichboden



REF	Ø cm	H cm	Lts	€	U
219.016	16	16,0	3,00	24,70	1
219.018	18	18,0	4,50	26,95	1
219.020	20	20,0	6,20	30,80	1

212 Baño maría sin fondo sandwich / Bain marie without sandwich bottom / Bain-marie sans fond sandwich / Wasserbad ohne Sandwichboden



REF	Ø cm	H cm	Lts	€	U
212.016	16	16,0	3,00	24,00	1
212.018	18	18,0	4,50	25,55	1
212.020	20	20,0	6,20	27,85	1

IDEA!

Perfecto para salsas /
Perfect for sauces /
Parfait pour sauces /
Perfekt für Sossen

204 Sautex / Sauté pan / Sauteuse / Sauteuse

CLASS
INDUCTION



REF	Ø cm	H cm	Lts	€	U
204.020	20	6,0	1,90	31,10	1
204.024	24	6,0	2,70	35,55	1
204.028	28	6,0	3,70	50,35	1
204.030	30	6,0	4,30	56,45	1
204.032	32	6,0	4,70	58,95	1
204.035	35	7,0	6,70	83,20	1
204.040*	40	8,0	10,00	94,65	1

* Con contraasa / With counterhandle /
Avec contre anse / Mit Zusatzgriff

201

Cazo recto bajo / Saucepan /
Casserole / Stielkasserolle

CLASS
INDUCTION



* Con contraasa / With counterhandle /
Avec contre anse / Mit Zusatzgriff

REF	Ø cm	H cm	Lts	€	U
201.016	16	7,5	1,50	26,85	1
201.018	18	8,0	2,00	27,75	1
201.020	20	8,0	2,50	31,20	1
201.024	24	9,5	4,30	36,05	1
201.028	28	11,0	6,70	52,40	1
201.032	32*	12,50	10,00	78,70	1

200

Cazo tipo francés / French style saucepan /
Casserole forme française / Französische Kasserolle

CLASS
INDUCTION



REF	Ø cm	H cm	Lts	€	U
200.012	12	7,0	0,70	24,40	1
200.014	14	7,0	1,00	26,75	1
200.016	16	7,5	1,50	26,85	1
200.018	18	9,0	2,30	31,30	1
200.020	20	10,0	3,10	35,15	1
200.022	22	11,0	4,20	38,00	1
200.024	24	12,0	5,40	41,95	1
200.028	28	14,0	8,60	58,65	1

214

Cazo cónico / Conical sauté pan /
Sauteuse evasée / Konische Stielkasserolle

CLASS
INDUCTION



REF	Ø cm	H cm	Lts	€	U
214.016	16	6,0	1,00	30,40	1
214.018	18	6,0	1,20	33,35	1
214.020	20	6,5	1,60	34,85	1
214.022	22	7,0	2,10	37,70	1
214.024	24	7,5	2,70	41,75	1

202

Cazo recto alto / Deep saucepan /
Casserole haute / Hohe Stielkasserolle

CLASS
INDUCTION



* Con contraasa / With counterhandle /
Avec contre anse / Mit Zusatzgriff

REF	Ø cm	H cm	Lts	€	U
202.016	16	11,0	2,10	27,25	1
202.018	18	12,0	3,00	32,20	1
202.020	20	13,0	4,00	36,70	1
202.024	24	14,0	6,30	43,45	1
202.028	28	17,5	10,20	61,40	1
202.032	32*	19,0	15,20	83,20	1

2001

Cazo con picos laterales /
Saucepan with side spouts /
Casserole avec becs verseurs /
Stielkasserolle mit Ausgüssen

CLASS
INDUCTION



REF	Ø cm	H cm	Lts	€	U
200.116	16	7,5	1,50	29,30	1
200.120	20	10,0	3,10	35,15	1

2003

Cazo bombeado /
Rounded saucepan /
Casserole bombée /
Kugelige Stielkasserolle mit Schüttrand

CLASS
INDUCTION



REF	Ø cm	H cm	Lts	€	U
200.320	20	7,5	1,80	31,60	1
200.324	24	8,5	3,00	36,35	1

HANDY



INOX - ST/STEEL
EDELSTAHL
18/10



INDUCTION



ESPAÑOL

BATERÍA DE ACERO INOXIDABLE CON ASAS TUBULARES, RESISTENTES AL CALOR.
FONDO TERMO DIFUSOR ENCAPSULADO.

ENGLISH

ST/STEEL COOKWARE WITH HEAT-RESISTANT TUBULAR HANDLES.
ENCAPSULATED SANDWICH BASE.

FRANÇAIS

BATTERIE DE CUISINE FABRIQUÉE EN ACIER INOXYDABLE AVEC ANSES TUBULAIRES RÉSITANTES À LA CHALEUR.
FOND THERMO-DIFFUSEUR ENCAPSULÉ

DEUTSCH

KOCHBEDARF AUS EDELSTAHL MIT HITZEBESTÄNDIGEN ROHRGRIFFEN.
KAPSELFÖRMIGER THERMODIFFUSIONSUNTERBODEN.

4008 Olla sin tapa / Stock pot without lid / Marmite traiteur sans couvercle / Kochtopf ohne Deckel



REF	Ø cm	H cm	Lts	€	U
400.824	24	20,0	9,00	48,65	1
400.828	28	24,0	14,50	74,15	1
400.832	32	28,0	22,50	102,75	1
400.835	35	30,0	28,50	137,20	1

4007 Cacerola baja sin tapa / Casserole without lid / Faitout sans couvercle / Flache Kasserolle ohne Deckel



REF	Ø cm	H cm	Lts	€	U
400.724	24	9,5	4,20	34,25	1
400.728	28	11,0	6,50	53,40	1
400.732	32	12,5	10,00	64,15	1
400.735	35	13,0	12,50	98,80	1

4006 Cacerola alta sin tapa / Sauce pot without lid / Braisière sans couvercle / Hohe Kasserolle ohne Deckel



REF	Ø cm	H cm	Lts	€	U
400.624	24	14,0	6,20	40,45	1
400.628	28	16,0	9,50	58,45	1
400.632	32	19,0	15,00	71,35	1
400.635	35	20,0	19,00	107,50	1
400.640	40	32,0	40,00	136,80	1

4005 Paellera sin tapa / Paella pan without lid / Plat à paella sans couvercle / Paellapfanne ohne Deckel

REF	Ø cm	H cm	Lts	€	U
400.524	24	6,0	2,70	33,85	1
400.528	28	6,0	3,70	47,00	1



4000 Cazo recto / Saucepan / Casserole / Hohe Kasserolle

REF	Ø cm	H cm	Lts	€	U
400.016	16	7,5	1,40	21,90	1
400.018	18	9,0	2,10	24,20	1
400.020	20	10,0	3,00	27,15	1
400.024	24	12,0	5,00	34,85	1



4003 Cazo bombeado / Rounded saucepan / Casserole bombée / Kugelige Stielkasserolle mit Schüttrand

REF	Ø cm	H cm	Lts	€	U
400.320	20	7,5	2,00	26,55	1
400.324	24	8,5	3,70	34,15	1



4004 Sautex / Sauté pan / Sauteuse / Sauteuse

REF	Ø cm	H cm	Lts	€	U
400.424	24	6,0	2,50	32,85	1



4009 Tapa / Lid / Couvercle / Deckel

REF	Ø cm	€	U
400.916	16	7,70	1
400.918	18	8,90	1
400.920	20	9,30	1
400.924	24	10,65	1
400.928	28	12,25	1
400.932	32	16,00	1
400.935	35	18,25	1
400.940	40	21,60	1





ESPAÑOL

BATERÍA DE ALUMINIO PURO 99,5% EXTRA FUERTE

ENGLISH

PURE 99,5% EXTRA STRENGTH ALUMINIUM COOKWARE

FRANÇAIS

BATTERIE DE CUISINE EN ALUMINIUM PUR À 99,5% EXTRA FORT

DEUTSCH

KOCHBEDARF AUS 99,5% EXTRA STARKEN ALUMINIUM

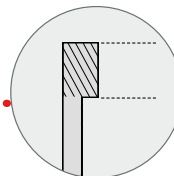
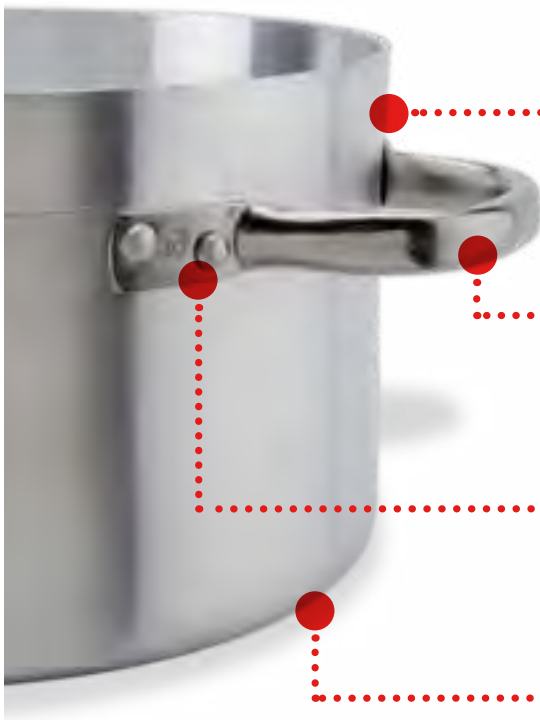

Bordes reforzados
Reinforced rims
Bords renforcés
Verstärkte Ränder

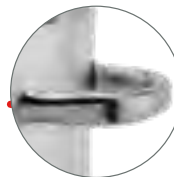

Asas ergonómicas
Ergonomic handles
Anses ergonomiques
Ergonomische Griffe



Remache de alta resistencia
Extremely strong riveted handles
Poignées rivetées de haute résistance
Extrem starke Vernietung

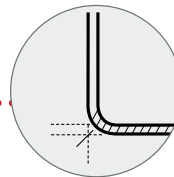

Fondo reforzado
Reinforced base
Fond renforcé
Verstärkter Boden



Excelente conductividad térmica y alta eficiencia en la difusión del calor
Excellent thermo conductivity and exceptional efficiency on heat distribution
Excellente conductivité thermique et haute efficacité en diffusion de la chaleur
Exzellente Wärmeleitung und hohe Effizienz der Hitzeverteilung

1181 Olla sin tapa / Stock pot without lid / Marmite traiteur sans couvercle / Kochtopf ohne Deckel



REF	Ø cm	H cm	Lts	€	U
118.120	20	20,0	6,20	36,05	1
118.125	25	25,0	12,00	45,40	1
118.127	27	27,0	15,00	54,40	1
118.130	30	30,0	21,20	59,05	1
118.132	32	32,0	25,50	62,75	1
118.135	35	35,0	33,60	75,35	1
118.140	40	40,0	50,00	101,00	1
118.145	45	45,0	72,00	123,75	1
118.150	50	50,0	98,00	137,25	1
118.160	60	60,0	155,00	212,50	1

1171 Cacerola baja sin tapa / Casserole without lid / Faitout sans couvercle / Flache Kasserolle ohne Deckel



REF	Ø cm	H cm	Lts	€	U
117.125	25	10,0	5,00	30,60	1
117.127	27	11,0	6,00	34,95	1
117.130	30	12,0	8,50	38,60	1
117.132	32	13,0	10,00	39,40	1
117.135	35	14,0	13,00	45,50	1
117.138	38	15,0	17,00	53,90	1
117.140	40	16,0	20,00	58,10	1
117.145	45	18,0	28,00	66,05	1
117.150	50	21,0	41,00	88,90	1
117.160	60	25,0	70,00	135,05	1

1161 Cacerola alta sin tapa / Sauce pot without lid / Braisière sans couvercle / Hohe Kasserolle ohne Deckel



REF	Ø cm	H cm	Lts	€	U
116.125	25	15,0	7,30	35,55	1
116.130	30	18,0	12,70	44,65	1
116.135	35	21,0	20,20	57,90	1
116.140	40	25,0	31,40	74,85	1
116.145	45	28,0	44,50	85,50	1
116.150	50	31,0	60,80	115,90	1
116.160	60	37,0	104,60	163,00	1

115 Paellera sin tapa / Paella pan without lid / Plat à paella sans couvercle / Paellapfanne ohne Deckel



REF	Ø cm	H cm	Lts	€	U
115.020	20	5,5	1,75	24,00	1
115.024	24	6,0	2,75	26,60	1
115.028	28	6,0	3,75	29,35	1
115.032	32	7,0	5,60	33,25	1
115.040	40	8,0	10,00	48,45	1
115.050	50	8,0	15,50	65,15	1
115.060	60	10,0	28,00	93,05	1

ALU-PRO

118 Olla con tapa / Stock pot with lid / Marmite traiteur avec couvercle / Kochtopf mit Deckel

REF	Ø cm	H cm	Lts	€	U
118.020	20	20,0	6,20	47,15	1
118.025	25	25,0	12,00	55,10	1
118.027	27	27,0	15,00	65,05	1
118.030	30	30,0	21,20	71,10	1
118.032	32	32,0	25,50	76,35	1
118.035	35	35,0	33,60	90,35	1
118.040	40	40,0	50,00	119,80	1
118.045	45	45,0	72,00	142,60	1
118.050	50	50,0	98,00	162,25	1
118.060	60	60,0	155,00	240,90	1

117 Cacerola baja con tapa / Casserole with lid / Faitout avec couvercle / Flache Kasserolle mit Deckel

REF	Ø cm	H cm	Lts	€	U
117.025	25	10,0	5,00	40,10	1
117.027	27	11,0	6,00	45,30	1
117.030	30	12,0	8,50	50,35	1
117.032	32	13,0	10,00	52,60	1
117.035	35	14,0	13,00	60,05	1
117.038	38	15,0	17,00	70,90	1
117.040	40	16,0	20,00	76,15	1
117.045	45	18,0	28,00	88,25	1
117.050	50	21,0	41,00	110,50	1
117.060	60	25,0	70,00	158,30	1

116 Cacerola alta con tapa / Sauce pot with lid / Braisière avec couvercle / Hohe Kasserolle mit Deckel

REF	Ø cm	H cm	Lts	€	U
116.025	25	15,0	7,30	45,05	1
116.030	30	18,0	12,70	56,45	1
116.035	35	21,0	20,20	72,70	1
116.040	40	25,0	31,40	93,25	1
116.045	45	28,0	44,50	104,95	1
116.050	50	31,0	60,80	140,60	1
116.060	60	37,0	104,60	190,60	1

1151 Paellera con tapa / Paella pan with lid / Plat à paella avec couvercle / Paellapfanne mit Deckel

REF	Ø cm	H cm	Lts	€	U
115.132	32	7,0	5,60	45,40	1
115.140	40	8,0	10,00	64,85	1
115.150	50	8,0	15,50	87,45	1
115.160	60	10,0	28,00	117,20	1

106 Sautex / Sauté pan / Sauteuse / Sauteuse



REF	Ø cm	H cm	Lts	€	U
106.020	20	5,5	1,75	21,75	1
106.024	24	6,0	2,75	24,40	1
106.028	28	6,0	3,75	27,70	1
106.032	32	7,0	5,60	33,85	1
106.040	40	8,0	10,00	57,30	1

103 Cazo bombeado / Rounded saucepan / Casserole bombée / Kugelige Stielkasserolle mit Schüttrand



REF	Ø cm	H cm	Lts	€	U
103.016	16	8,0	1,00	18,65	1
103.018	18	9,0	2,00	20,25	1
103.020	20	10,5	2,50	23,40	1
103.022	22	11,0	3,00	25,10	1
103.024	24	12,0	4,00	27,70	1
103.028	28	14,0	6,50	31,95	1

104 Cazo recto / Saucepan / Casserole / Gerade Kasserolle



REF	Ø cm	H cm	Lts	€	U
104.016	16	8,0	1,50	18,45	1
104.018	18	9,0	2,00	20,05	1
104.020	20	10,0	3,00	22,55	1
104.022	22	11,0	4,00	24,20	1
104.024	24	12,0	5,00	26,60	1
104.026	26	13,0	6,00	29,70	1

112 Tapa / Lid / Couvercle / Deckel



REF	Ø cm	€	U
112.020	20	10,10	1
112.025	25	10,60	1
112.027	27	11,60	1
112.030	30	13,15	1
112.032	32	14,40	1
112.035	35	15,85	1
112.038	38	18,55	1
112.040	40	19,55	1
112.045	45	24,20	1
112.050	50	26,80	1
112.060	60	29,50	1





SARTENES

ESPAÑOL

MANGOS:

LOS MANGOS SON UNO DE LOS ELEMENTOS DE DIFERENCIACIÓN FUNCIONAL MÁS IMPORTANTES. DE ESTA FORMA PUJADAS ADAPTÁNDOSE A LAS NUEVAS TENDENCIAS EN EL SECTOR DE LA COCINA PROFESIONAL IMPULSA Y PROMOCIONA LOS DISEÑOS:

ERGOS: FABRICADOS EN TUBO DE ACERO INOXIDABLE, CON UN DISEÑO ERGONÓMICO Y EXCLUSIVO, RESISTENTE A LA TRANSMISIÓN DEL CALOR. MÁXIMO RENDIMIENTO EN LA COCINA PROFESIONAL.

HÉRCULES: MANGOS TRADICIONALES FABRICADOS EN HIERRO PLANO CON RECUBRIMIENTO "EPOXY" RESISTENTE AL CALOR. ALTAMENTE ACONSEJADOS PARA UN USO INTENSIVO.

BAQUELITA: FABRICADOS EN 100% BAQUELITA, AISLANTE DEL CALOR Y MÁS LIGEROS. IDEALES PARA UN USO DOMÉSTICO O POCO FRECUENTE.

ANTIADHERENTES:

SARTENES DE ALUMINIO: ANTIADHERENTE PROFESIONAL MULTICAPA EN LAS SARTENES DE 4 MM DE ESPESOR Y TITANIUM EN LAS DE 5 MM. BUENA RESISTENCIA A LA ABRASIÓN Y LARGA DURABILIDAD.

SARTENES DE ACERO INOXIDABLE Y MULTIMETAL: EXCALIBUR, ANTIADHERENTE DE ÚLTIMA GENERACIÓN BASADO EN UN REFUERZO DE ACERO INOXIDABLE QUE SE INTEGRA EN EL SUBSTRATO METÁLICO PASANDO A FORMAR PARTE DEL MISMO Y LOGRANDO LA COMBINACIÓN ÚNICA DE LA DUREZA DEL ACERO INOXIDABLE CON LAS CARACTERÍSTICAS DE ANTIADHERENCIA. RESISTENTE A LA EROSIÓN DE LOS UTENSILIOS MÁS AGRESIVOS. (VER CUADRO INFORMATIVO).

FRY PANS

ENGLISH

HANDLES:

HANDLES ARE ONE OF THE MOST IMPORTANT DIFFERENTIATING FUNCTIONAL ELEMENTS. PUJADAS HAS ADAPTED TO THE LATEST TRENDS IN THE PROFESSIONAL COOKING SECTOR AND FOR THIS REASON HIGHLIGHTS AND PROMOTES THE FOLLOWING DESIGNS:

ERGOS: MADE OF ST/STEEL TUBE WITH AN EXCLUSIVE, HEAT-RESISTANT, ERGONOMIC DESIGN. THE BEST PERFORMANCE WITH PROFESSIONAL USE.

HERCULES: TRADITIONAL HANDLES MADE OF FLAT IRON WITH A HEAT RESISTANT "EPOXY" COATING. HIGHLY RECOMMENDED FOR INTENSIVE USE.

BAKELITE: MADE OF 100% HEAT-RESISTANT BAKELITE. SUGGESTED FOR HOUSEHOLD OR NON-INTENSIVE USE.

NON-STICK COATINGS:

ALUMINIUM FRY PANS: NON-STICK PROFESSIONAL MULTI LAYER COATING APPLIED ON THE 4 MM THICK FRY PANS AND TITANIUM ON THE 5 MM ONES. LONG-LASTING AND HIGH RESISTANCE TO ABRASION.

ST/STEEL AND MULTIMETAL FRY PANS: EXCALIBUR, A NON-STICK COATING OF THE LATEST GENERATION. A SYSTEM WHERE THE NON-STICK COATING FORMS AN INTEGRAL PART OF THE BASE DUE TO THE ADDITION OF A COAT OF POWDERED ST/STEEL. EFFECTIVELY COMBINING THE DURABILITY OF ST/STEEL WITH THE NON-STICK PROPERTIES OF THE FLUOROPOLYMER. RESISTANT TO THE EFFECTS OF THE MOST AGGRESSIVE KITCHEN UTENSILS. (SEE INFORMATIVE TABLE).

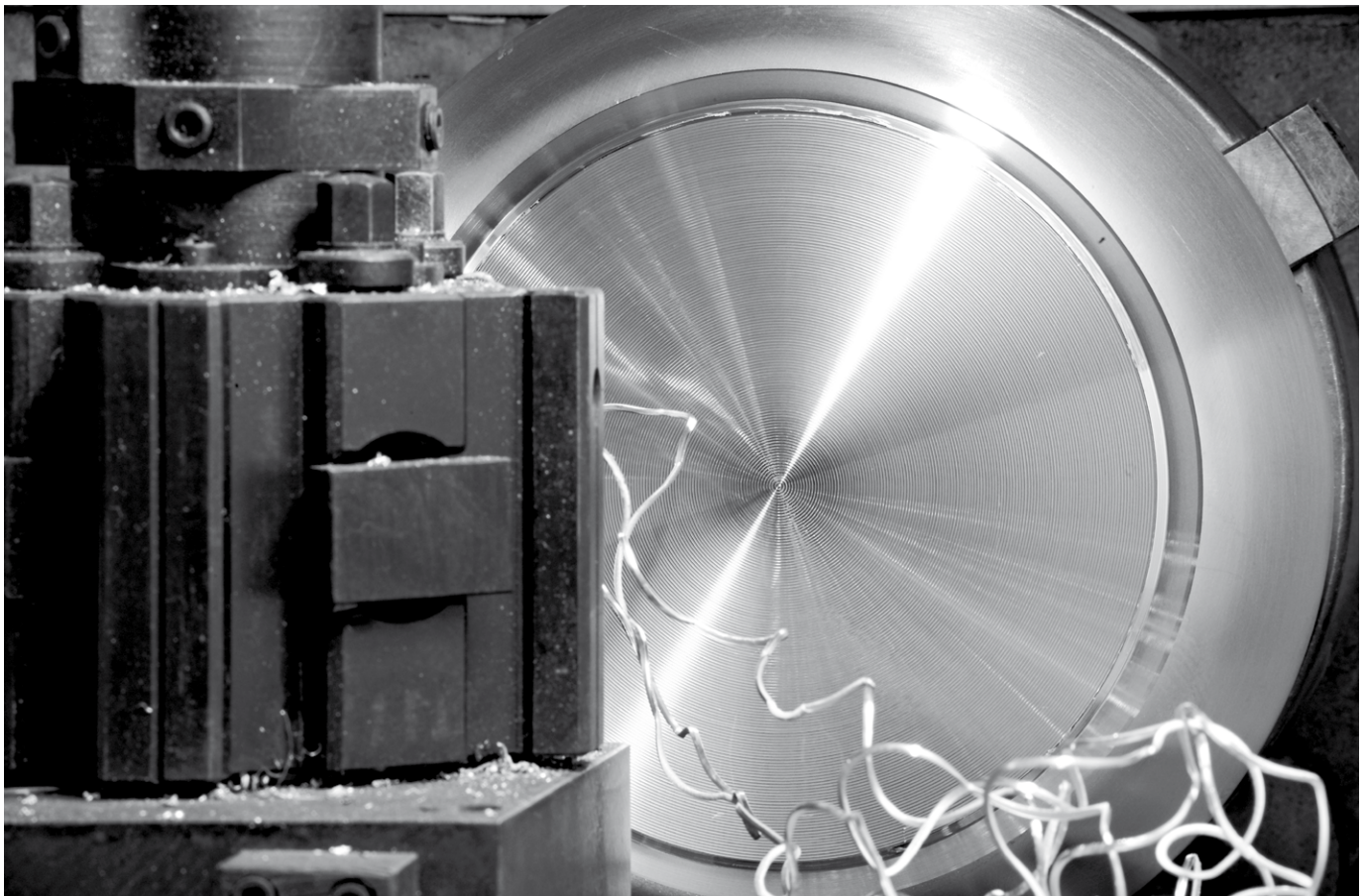

POÊLES

FRANÇAIS

QUEUES :

LES QUEUES SONT UN DES ÉLÉMENTS DE DIFFÉRENCIATION FONCTIONNELLE LES PLUS IMPORTANTS. AINSI DONC, PUJADAS EN S'ADAPTANT AUX NOUVELLES TENDANCES DU SECTEUR DE LA CUISINE PROFESSIONNELLE, OPTÉ ET MISE POUR LES NOUVEAUX DESSINS:

ERGOS: FABRIQUÉES EN TUBE D'ACIER INOXYDABLE, DESSIN ERGONOMIQUE ET EXCLUSIF, RÉSISTANT À CHALEUR. RENDEMENT MAXIMAL EN UTILISATION PROFESSIONNELLE.

HÉRCULES: FORME TRADITIONNELLE EN FER À REVÊTEMENT "ÉPOXY", RÉSISTANT À LA CHALEUR. HAUTEMENT RECOMMANDÉS POUR UNE UTILISATION INTENSIVE.

BAKÉLITE: FABRIQUÉES 100% BAKÉLITE, RÉSISTANTES À LA CHALEUR ET PLUS LÉGÈRES. IDÉALES POUR UNE UTILISATION DOMESTIQUE OU PEU FRÉQUENTE.

ANTI-ADHÉSIF :

POÊLES EN ALUMINIUM : REVÊTEMENT PROFESSIONNEL ANTI-ADHÉRENT MULTICOUCHE APPLIQUÉ SUR LES POÊLES DE 4MM D'ÉPAISSEUR ET TITANIUM SUR CELLES DE 5MM. LONGUE ET FORTE RÉSISTANCE À L'ABRASION.

POÊLES EN ACIER INOXYDABLE ET MULTI-MÉTAL : EXCALIBUR, UN REVÊTEMENT DE NOUVELLE GÉNÉRATION, BASÉ SUR UN RENFORT EN ACIER INOXYDABLE, QUI S'INTÈGRE DANS LE SUBSTRAT MÉTALLIQUE DONT IL FAIT PARTIE, CE QUI DONNE UNE COMBINAISON UNIQUE ENTRE LA DURETÉ DE L'ACIER ET LES CARACTÉRISTIQUES DE L'ANTI-ADHÉSIF. LE REVÊTEMENT EXCALIBUR RÉSISTE MÊME AUX USTENSILES LES PLUS DURS. (VOIR TABLEAU INFORMATIF).



DETALLE TRATAMIENTO ANTIADHERENTE / NON-STICK COATING TREATMENT / DÉTAIL APPLICATION ANTI-ADHÉSIF / BEHANDLUNG MIT ANTIHAFTBESCHICHTUNG



1 Para dar rugosidad a la superficie de la pieza se chorrea con elementos abrasivos y con ello se logra un buen anclaje del excalibur.

1 The surface of the substrate is blasted with an abrasive to roughen it, so other elements in the excalibur process adhere to it better.

1 Afin de la rendre rugueuse, la surface de la pièce est sablée avec un abrasif; ceci permettra une excellente tenue du procédé excalibur.

1 Um der Oberfläche eine Rauheit zu geben wird sie mit rauen Elementen bestrahlt. Dies erlaubt einen exzellenten Halt von anderen Elementen im Excalibur Prozess.



3 Las partículas se enfrían, formando parte integral de la superficie con "picos" y "valles" que permiten alojar las capas de antiadherente de forma permanente.

3 The particles cool and harden, bonded to the surface, forming a series of "peaks and valleys" that provide a permanent base for the non-stick coatings.

3 Ces particules se refroidissent, forment des crêtes et des vallées constituant une excellente base permanente d'accrochage et de renforcement de l'anti-adhésif.

3 Die Partikel kühlen sich ab und integrieren sich in der Oberfläche in Form von "Höhen und Tiefen". Dies ermöglicht eine permanente Grundlage für die Antihafbeschichtung.

BRATPFANNEN

DEUTSCH

GRIFFE :

DIE GRIFFE SIND EINE DER WICHTIGSTEN UNTERSCHIEDUNGSMERKMALE DER FUNKTIONALITÄT. PUJADAS WIRD VON DEN NEUESTEN TRENDS DER PROFESSIONELLEN KÜCHE ANGETRIEBEN UND ENTWICKELT FOLGENDE DESIGNS:

ERGOS: FERTIGUNG AUS ROSTFREIEM EDELSTAHLROHR, EXCLUSIVES UND ERGONOMISCHES DESIGN, HITZEBESTÄNDIGKEIT, MAXIMALE HANDHABUNG IN DER PROFESSIONELLEN KÜCHE.

HÉRCULES: TRADITIONELL GEFERTIGTE GRIFFE AUS FLACHEISEN MIT DER "ÉPOXY" BESCHICHTUNG, HITZEBESTÄNDIG. HÖCHST EMPFEHLENSWERT BEI EINEM INTENSIVEN GEBRAUCH.

BAKELITE: GEFERTIGT AUS 100% BAKELITE, HITZEBESTÄNDIG UND SEHR LEICHT. IDEAL FÜR DEN HAUSGEBRAUCH ODER WENIGEN GEBRAUCH.

ANTIHAFT BESCHICHTUNG:

BRATPFANNEN AUS ALUMINIUM: MEHRFACHE PROFESSIONELLE ANTIHAFTBESCHICHTUNG DER BRATPFANNEN VON 4MM DICKE UND TITANIUM VON 5MM DICKE. GUTE WIDERSTANDFÄHIGKEIT GEGEN VERSCHLEISS UND FÜR DIE LANGLEBIGKEIT.

BRATPFANNEN AUS EDELSTAHL UND MULTIMETALL: EXCALIBUR, ANTIHAFTBESCHICHTUNG DER NEUESTEN GENERATION BASIEREND AUF EINE VERSTÄRKUNG DURCH EDELSTAHL, DASS SICH IM METALLISCHEM SUBSTRAT SO INTEGRIERT, DASS ES EIN BESTANDTEIL DESSELBEN WIRD. HIERDURCH WIRD EINE EINZIGARTIGE KOMBINATION VON STAHLHÄRTE UND ANTIHAFTUNG ERREICHT. RESISTENT GEGEN DIE AGGRESSIVSTEN UTENSILIEN. (SIEHE WEITERE INFORMATIONEN UNTEN)



2 La parte más importante del proceso: la pulverización y deposición de las partículas fundidas de una aleación de acero inoxidable, patentada por whitford.

2 Then, the most important part: white-hot particles of a special stainless steel (whitford's patented alloy) are sprayed onto the roughened surface.

2 Le processus plus important: des particules d'un acier inoxydable spécial (protégé par brevet par whitford) sont chauffées à blanc et pulvérisées sur la pièce.

2 Der wichtigste Prozessschritt: Die Pulverisierung und Ablagerung der Schmelzpartikel formt sich zu einer speziellen Legierung (whitford Legierung patentiert).



4 Finalmente se aplican varias capas de fluoropolímeros que rellenan los "valles" y cubren los "picos", los cuales protegen el recubrimiento antiadherente.

4 Several coats of tough fluoropolymers fill the "valleys" and cover the "peaks", held permanently in place by the special stainless steel "peaks".

4 Des couches d'anti-adhésif très résistant sont appliquées; elles remplissent les vallées, recouvrent juste le haut des crêtes qui les maintiennent fermement en place.

4 Schliesslich werden unterschiedliche Schichten aus Fluorpolymer über die "Höhen und Tiefen" aufgetragen, um die Antihafbeschichtung zu schützen.

PROFESIONAL / PROFESSIONAL / PROFESSIONNEL / PROFESSIONELL

	ACERO INOXIDABLE / ST/STEEL / ACIER INOXYDABLE / ROSTFREIER STAHL	ALUMINIO INDUCCIÓN / INDUCTION ALUMINIUM / ALUMINIUM INDUCTION / ALUMINIUMINDUKTION	ALUMINIO / ALUMINIUM / ALUMINIUM / ALUMINIUM	ACERO / STEEL / ACIER / STAHL
REF / ITEM / CODE / ART.NR.				
COMPATIBLE CON / COMPATIBLE WITH / COMPATIBLE AVEC / GEEIGNET FÜR				
PRECIO / PRICE / PRIX / PREIS	€€€	€	€	€
ESPESOR / THICKNESS / EPAISSEUR / DICKE	0,8 mm	4 mm	4,5 mm	1,5 mm
ANTIADHERENTE / COATING / REVÊTEMENT / ANTIHAFTBESCHICHTUNG				NINGUNO / NONE / AUCUN / KEINE
MANGO / HANDLE / QUEUE / GRIFF	INOXIDABLE / ST/STEEL / INOXYDABLE / ROSTFREI	INOXIDABLE / ST/STEEL / INOXYDABLE / ROSTFREI	INOXIDABLE / ST/STEEL / INOXYDABLE / ROSTFREI	HIERRO / FLAT IRON / FER / EISEN
RECOMENDADA / RECOMMENDED / RECOMMANDÉE / EMPFEHLUNG	ALTA RESISTENCIA A LA ABRASIÓN / HIGH RESISTANCE TO ABRASION / HAUTE RÉSIDENCE À L'ABRASION / HOHE RESISTENZ GEGEN VERSCHLEISS	ALTA RESISTENCIA A LA ABRASIÓN / HIGH RESISTANCE TO ABRASION / HAUTE RÉSIDENCE À L'ABRASION / HOHE RESISTENZ GEGEN VERSCHLEISS	COCCIÓN A FUEGO LENTO / SLOW BAKING / CUISSON À FEU LENT / KOCHEN MIT KLEINER FLAMME	SELLAR, FREIR, DORAR / SEALING, FRYING, BROWNING / CULOTTAGE, FRIRE ET DORER / ANBRATEN, FRITIEREN, ANBRÄUNEN



FOODIES

PUJADAS 1921	BLACK SERIES	MULTIMETAL	IDEA	APARTAMENTO
				
   	   	   	   	  
€€	€€	€€€€	€€	€
2 mm	4 mm	3,5 mm	0,7 mm	2,5 mm
CERÁMICO / CERAMIC / CÉRAMIQUE / KERAMIK 				ANTIADHERENTE / NON-STICK / ANTI-ADHÉSIF / ANTIHAFT
INOXIDABLE / ST/STEEL / INOXYDABLE / ROSTFREI	INOXIDABLE / ST/STEEL / INOXYDABLE / ROSTFREI	INOXIDABLE / ST/STEEL / INOXYDABLE / ROSTFREI	INOXIDABLE / ST/STEEL / INOXYDABLE / ROSTFREI	BAQUELITA / BAKELITE / BAKÉLITE / BAKELITE
ALTAS TEMPERATURAS / HIGH TEMPERATURES HAUTES TEMPERATURES / HOHE TEMPERATUREN	ROBUSTEZ Y BUEN DESGLIZAMIENTO / ROBUSTNESS AND GOOD SLIDING / ROBUSTESSE ET BON GLISSEMENT / ROBUSTHEIT UND GUTES RUTSCHEN	HOMOGENEIDAD Y EFICACIA TÉRMICA / HOMOGENEITY AND THERMAL EFFECTIVENESS / HOMOGÉNÉITÉ ET EFFICACITÉ THERMIQUE / HOMOGENITÄT UND WÄRMEFFIZIENZ	RESISTENCIA PROFESIONAL / PROFESSIONAL STRENGTH / DURETÉ PROFESSIONNEL / PROFESSIONELLE RESISTENZ	RESISTENCIA PROFESIONAL / PROFESSIONAL STRENGTH / DURETÉ PROFESSIONNEL / PROFESSIONELLE RESISTENZ



ALUMINIO / ALUMINIUM



ANTIADHERENTE / NON-STICK COATING / ANTI-ADHÉSIF/ ANTIHAFTBESCHICHTUNG

ESPAÑOL
FABRICADAS EN ALUMINIO CON RECUBRIMIENTO ANTIADHERENTE, ADAPTADAS A TODO TIPO DE COCINAS EXCEPTO INDUCCIÓN. NO APTAS PARA HORNOS.

ENGLISH
MADE OF ALUMINIUM WITH NON-STICK COATING, SUITABLE FOR ANY KIND OF STOVE EXCEPT INDUCTION AND OVEN.

FRANÇAIS
FABRIQUÉES EN ALUMINIUM AVEC REVÊTEMENT ANTI-ADHÉSIF, RECOMMANDÉES POUR TOUT TYPE DE FEUX, SAUF INDUCTION. NE PAS UTILISER AUX FOURS.

DEUTSCH
HERSTELLUNG AUS ALUMINIUM MIT ANTIHAFTBESCHICHTUNG, ANGEPASST AN ALLE KOCHARTEN AUSSCHLIESSLICH INDUKTION UND OFEN.

120 Sartén antiadherente "ERGOS" / Non-stick fry pan "ERGOS" / Poêle anti-adhésive "ERGOS" / Antihaft Bratpfanne "ERGOS"



Fácil limpieza / Easy to clean / Facile à nettoyer / Einfaches Reinigen

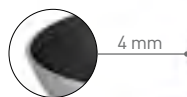

Fondo plano
Plain base
Fond plain
Glatter Unterboden

REF	Ø cm	H cm	€	U
120.018	18	4,0	19,45	12
120.020	20	4,0	21,75	12
120.022	22	4,5	22,65	12
120.024	24	4,5	25,65	6
120.026	26	5,0	28,95	6
120.028	28	5,0	32,65	6
120.032	32	5,5	38,25	6
120.036	36	6,0	45,80	6
120.040	40	6,5	53,05	6

128 Sartén antiadherente "HERCULES" / Non-stick fry pan "HERCULES" / Poêle anti-adhésive "HERCULES" / Antihaft Bratpfanne "HERCULES"



Fácil limpieza / Easy to clean / Facile à nettoyer / Einfaches Reinigen



Fondo plano
Plain base
Fond plain
Glatter Unterboden

REF	Ø cm	H cm	€	U
128.018	18	4,0	16,25	12
128.020	20	4,0	17,20	12
128.022	22	4,5	19,15	12
128.024	24	4,5	20,85	6
128.026	26	5,0	23,35	6
128.028	28	5,0	25,00	6
128.032	32	5,5	29,25	6
128.036	36	6,0	35,60	6
128.040	40	6,5	41,45	6

128 Sartén antiadherente "HERCULES" mango colores / Non-stick FRY PAN "HERCULES" Coloured handles / Poêle anti-adhésif "HERCULES" Queue à couleurs / Antihaft Bratpfanne "HERCULES" farbige Griffe



REF	ROJO/RED ROUGE/ROT	AMARILLO/YELLOW JAUNE/GELB	AZUL/BLUE BLEU/BLAU	VERDE/GREEN VERT/GRÜN	Ø cm	H cm	€	U
128	1	2	3	4	20	4,0	19,60	1
128	1	2	3	4	24	4,5	23,35	1
128	1	2	3	4	28	5,0	28,00	1
128	1	2	3	4	32	5,5	32,25	1

- Carnes rojas / Red meat / Viande rouge / Rotes Fleisch
- Carnes blancas y huevos / White meat and eggs / Volaille et oeufs / Weisses Fleisch und Eier
- Pescado / Fish / Poisson / Fisch
- Verdura / Vegetables / Legumes / Gemüse

Ref: 128 + (Color / Colour / Couleur / Farbe) + Ø

140 Sartén antiadherente "ERGOS TITANIUM" / Non-stick FRY PAN "ERGOS TITANIUM" / Poêle anti-adhésive "ERGOS TITANIUM" / Antihaft Bratpfanne "ERGOS TITANIUM"



REF	Ø cm	H cm	€	U
140.018	18	4,0	24,25	1
140.020	20	4,0	28,10	1
140.024	24	4,5	35,90	1
140.028	28	5,0	39,05	1
140.032	32	5,5	46,95	1
140.036	36	6,0	54,15	1
140.040	40	6,5	57,45	1



Fondo torneado
Ground base
Fond dressé
Gedrechselter Unterboden



Antiadherente / Non-stick
Anti-adhésif / Antihaft

148 Sartén honda "HERCULES" antiadherente / Non-stick sauté pan "HERCULES" / Sauteuse évasée en anti-adhésive "HERCULES" / Antihaft tiefe Bratpfanne "HERCULES"



REF	Ø cm	H cm	€	U
148.020	20	6,5	25,10	1
148.024	24	7,0	31,05	1
148.028	28	7,5	35,90	1
148.032	32	8,0	45,60	1

125 Sartén rectangular pescado "ERGOS" antiadherente / Non-stick rectangular FRY pan for fish "ERGOS" / Poêle rectangulaire à poisson "ERGOS" anti-adhésive / Antihaft rechteckige Fischbratpfanne "ERGOS"



REF	cm	H cm	€	U
125.038	38 x 26	5,0	42,85	1

127 Sartén "ERGOS" expert / Fry pan "ERGOS" expert / Poêle "ERGOS" expert / Bratpfanne "ERGOS" Expert



REF	Ø cm	H cm	€	U
127.020	20	4,0	19,45	1
127.024	24	4,5	23,35	1
127.028	28	5,0	29,45	1
127.032	32	5,5	34,85	1
127.036	36	6,0	41,55	1
127.040	40	6,5	47,35	1

124 Paellera antiadherente / Non-stick paella pan / Plat à paella anti-adhésif / Paellapfanne Antihaft



REF	Ø cm	H cm	€	U
124.020	20	4,0	22,90	1
124.024	24	4,5	27,15	1
124.028	28	5,0	34,55	1
124.032	32	5,5	40,40	1
124.036	36	6,0	48,40	1
124.040	40	6,5	56,00	1

Asas de acero inox / St/Steel handle /
Anses en acier inox / Griffe aus rostfreiem Stahl

131 Sartén para crêpes "HERCULES" antiadherente / Non-stick crêpe fry pan "HERCULES" / Poêle à crêpes "HERCULES" anti-adhésive / Crêpepfanne "HERCULES" Antihaft



REF	Ø cm	H cm	€	U
131.022	22	2,5	15,95	1
131.026	26	2,5	19,60	1

139 Sartén para blinis antiadherente / Non-stick blinis fry pan / Poêle à blinis anti-adhésive / Bratpfanne für Blinis Antihaft



REF	Ø cm	H cm	€	U
139.012	12	2,0	8,55	1

IDEA!

Especial para huevo frito / Specially for fried egg / Spécialement pour œuf frit / Speziell für Spiegeleier

1208 Sartén con antiadherente cerámico / Fry pan with ceramic non-stick coating / Poêle à revêtement anti-adhésif céramique / Bratpfanne mit keramischer Antihaftbeschichtung



REF	Ø cm	H cm	€	U
120.820	20	4,0	25,40	1
120.824	24	4,5	32,90	1
120.828	28	5,0	40,25	1
120.832	32	5,5	48,85	1

Fondo chapa inox. inducción / St/Steel sheet induction bottom / Fond plaque inox. induction / Rostfreier Stahlblechunterboden Induktion



1209 Sartén antiadherente fondo inducción "ERGOS" / Non-stick induction fry pan "ERGOS" / Poêle anti-adhésive fond induction "ERGOS" / Bratpfanne Antihaft Induktion "ERGOS"



ANTIADHERENTE / NON-STICK COATING / ANTI-ADHÉSIF / ANTIHAFTBESCHICHTUNG



REF	Ø cm	H cm	€	U
120.920	20	4,0	23,00	1
120.924	24	4,5	26,65	1
120.928	28	5,0	34,05	1
120.932	32	5,5	39,45	1

Fondo chapa inox. inducción / St/Steel sheet induction bottom / Fond plaque inox. induction / Rostfreier Stahlblechunterboden Induktion



1289 Sartén antiadherente fondo inducción "HERCULES" / Non-stick induction fry pan "HERCULES" / Poêle anti-adhésive fond induction "HERCULES" / Bratpfanne Antihaft Induktion "HERCULES"



ANTIADHERENTE / NON-STICK COATING / ANTI-ADHÉSIF / ANTIHAFTBESCHICHTUNG



REF	Ø cm	H cm	€	U
128.920	20	4,0	19,35	1
128.924	24	4,5	24,80	1
128.928	28	5,0	28,65	1
128.932	32	5,5	33,95	1

Fondo chapa inox. inducción / St/Steel sheet induction bottom / Fond plaque inox. induction / Rostfreier Stahlblechunterboden Induktion





ESPAÑOL

FABRICADAS EN ACERO INOXIDABLE 18/10, ADAPTADAS A TODO TIPO DE COCINAS INCLUIDAS LA DE INDUCCIÓN.

ENGLISH

MADE OF 18/10 ST/STEEL. SUITABLE FOR ANY KIND OF STOVES, INCLUDING INDUCTION.

FRANCAIS

FABRIQUÉE EN ACIER INOXYDABLE 18/10. RECOMMANDÉES POUR TOUT TYPE DE FEUX, ET COMPRIS INDUCTION.

DEUTSCH

HERGESTELLT AUS ROSTFREIEM STAHL 18/10. GEEIGNET FÜR ALLE KÜCHEN INKLUSIVE INDUKTION.

220 Sartén antiadherente excalibur "ERGOS" / Non-stick "ERGOS" excalibur fry pan / Poêle anti-adhésive excalibur "ERGOS" / Bratpfanne Antihaft excalibur "ERGOS"



**CLASS
INDUCTION**

Fondo sandwich
Sandwich bottom
Fond sandwich
Sandwichboden



REF	Ø cm	H cm	€	U
220.018	18	3,5	41,10	1
220.020	20	3,8	41,60	1
220.022	22	4,2	46,50	1
220.024	24	4,6	49,55	1
220.026	26	5,0	55,30	1
220.028	28	5,5	60,20	1
220.032	32	6,0	70,70	1
220.036	36	6,0	97,20	1
220.040	40	6,5	112,70	1

ANTIADHERENTE / NON-STICK COATING /
ANTI-ADHÉSIF / ANTIHAFTBESCHICHTUNG



2208 Sartén antiadherente cerámico / Fry pan with ceramic non-stick coating / Poêle revêtement anti-adhésif céramique / Bratpfanne keramische Antihafbeschichtung



CLASS INDUCTION



REF	Ø cm	H cm	€	U
220.818	18	3,5	39,45	1
220.820	20	3,8	40,40	1
220.824	24	4,6	47,25	1
220.828	28	5,5	57,30	1
220.832	32	6,0	68,05	1
220.836	36	6,0	93,00	1
220.840	40	6,5	104,65	1

ANTIADHERENTE / NON-STICK COATING / ANTI-ADHÉSIF / ANTIHAFTBESCHICHTUNG



213 Sarten "EXPERT" / "EXPERT" fry pan / Poêle "EXPERT" / Bratpfanne "EXPERT"



CLASS INDUCTION

Fondo sandwich
Sandwich base
Fond sandwich
Sandwichboden



REF	Ø cm	H cm	€	U
213.018	18	3,5	30,80	1
213.020	20	3,8	32,25	1
213.022	22	4,2	34,90	1
213.024	24	4,6	37,15	1
213.026	26	5,0	42,00	1
213.028	28	5,5	45,10	1
213.032	32	6,0	54,25	1
213.036	36	6,0	69,25	1
213.040	40	6,5	81,10	1

2393 Wok fondo redondo / Round base wok / Wok à fond rond / Wok mit rundem Boden



CLASS INDUCTION



REF	Ø cm	H cm	Lts	€	U
239.336	36	10,0	6,00	46,10	1

2392 Wok fondo plano / Flat base wok / Wok à fond plain / Wok mit flachem Boden



CLASS INDUCTION



REF	Ø cm	H cm	Lts	€	U
239.236	36	9,0	5,50	46,10	1



ESPAÑOL

FABRICADAS EN ACERO CON EXCELENTES PROPIEDAS TÉRMICAS Y ANTIADHERENTES NATURALES. APTAS PARA HORNOS.
LIMPIEZA: NO ES NECESARIO UTILIZAR NINGÚN TIPO DE JABÓN O AGUA. ES SUFICIENTE, FROTAR SUAVEMENTE CON UN PAÑO HUMEDECIDO CON ACEITE.

ENGLISH

MADE OF CARBON STEEL WITH EXCELLENT THERMAL AND NATURAL NON-STICK PROPERTIES. FLASH OVEN BAKING POSSIBLE.
CLEANING: AVOID SOAP OR WATER, JUST WIPE THEM WITH AN OILED TISSUE OR CLOTH.

FRANÇAIS

FABRIQUÉES EN ACIER OFFRANT D'EXCELLENTE PROPRIÉTÉS THERMIQUES ET ANTIADHÉSIVES NATURELLES. APTE POUR
UTILISATION EN FOUR.

NETTOYAGE : EVITER LE SAVON ET L'EAU. UNIQUEMENT FROTTER DOUCEMENT AVEC UN CHIFFON IMBIBÉ D'HUILE.

DEUTSCH

HERGESTELLT AUS STAHL MIT EXZELLENTE THERMISCHEN EIGENSCHAFTEN UND NATÜRLICHER ANTIHAFTBESCHICHTUNG.
GEEIGNET FÜR ÖFEN.

REINIGUNG: KEIN GEBRAUCH VON SPÜLMITTEL ODER WASSER NÖTIG. MIT EINEM GEÖLTEN TUCH AUSREIBEN, REICHT AUS.

1351 Sartén "Lionesa" 1,5 mm / "Lyonnaise" Steel fry pan 1,5 mm / Poêle "Lyonnaise" 1,5 mm / Bratpfanne "Lyoner" 1,5 mm



REF	Ø cm	H cm	€	U
135.120	20	4,5	10,30	1
135.124	24	5,0	13,35	1
135.128	28	5,5	17,30	1
135.132	32	6,0	21,45	1
135.136	36	6,5	27,70	1
135.140	40	7,0	34,85	1

1353 Wok / Wok / Wok / Wok



REF	Ø cm	H cm	€	U
135.330	30	9,5	37,55	1

1354 Sartén para crêpes / Crêpe fry pan / Poêle à crêpes / Crêpesbratpfanne



REF	Ø cm	H cm	€	U
135.424	24	2,0	19,60	1

PAELLERA / SPANISH PAELLA PAN / PLAT À PAELLA / PAELLAPFANNE

994 Paellera valenciana en acero pulido / Black steel spanish paella pan /
Plat à paella tôle acier / Spanische Paellapfanne aus poliertem Stahl



REF	Ø cm	RACIONES / PORTIONS PORTIONEN	€	U
994.020	20	1	5,05	1
994.022	22	1	5,15	1
994.024	24	1	5,60	1
994.026	26	2	5,95	1
994.030	30	4	6,85	1
994.032	32	5	7,85	1
994.034	34	6	8,30	1
994.036	36	7	9,60	1
994.038	38	8	10,05	1
994.040	40	9	10,60	1
994.042	42	10	12,40	1
994.046	46	12	13,80	1
994.050	50	14	16,35	1
994.055	55	16	26,70	1
994.065	65	22	39,80	1
994.080	80	40	82,70	1
994.090	90	50	109,05	1

995 Paellera acero esmaltado / Enamelled steel paella pan /
Plat à paella acier émaillé / Paellapfanne aus emailliertem Stahl



*MINI-SIZE

IDEA!

Ideal para tapas
Recommended for snacks
Recommandé pour tapas
Ideal für Snacks

REF	Ø cm	RACIONES / PORTIONS PORTIONEN	€	U
995.010 *	10	-	4,75	1
995.016 *	15	-	5,50	1
995.020	20	2	7,45	1
995.026	26	2	8,60	1
995.030	30	4	10,70	1
995.034	34	6	13,15	1
995.036	36	7	17,05	1
995.038	38	8	15,95	1
995.040	40	9	19,15	1
995.042	42	10	19,35	1
995.050	50	14	29,60	1
995.060	60	19	45,70	1

997 Sartén honda esmaltada con asas / Deep enamelled fry pan with handles /
Poêle haute avec anses / Tiefe Paellapfanne aus emailliertem Stahl mit Griffen



*MINI-SIZE

IDEA!

Ideal para tapas
Recommended for snacks
Recommandé pour tapas
Ideal für Snacks

REF	Ø cm	Lts	€	U
997.014 *	14	0,40	5,05	1
997.016 *	16	0,50	5,40	1
997.028	28	3,90	9,10	1
997.032	32	5,30	11,60	1
997.036	36	7,80	15,50	1
997.040	40	9,40	19,65	1

998 Paellero esmaltado gas / Enamelled gas burner / Brûleur émaillé / Emailierter Gasbrenner

REF	Ø cm	CIRCULOS / CIRCLES / CERCLES / KREIS	Kw	€	U
998.035	35	2	9,4	46,35	1
998.050	50	2	14,1	90,95	1
998.070	70	3	24,1	246,10	1

Válido para gas butano y propano NO para gas ciudad
Valid only for gas butane and propane
Valable uniquement pour gaz butane et propane /
Geeignet nur für Butan- und Propangas

Ref. 998.035

Para paelleras de 20 a 50 cm Ø
For paella pans from Ø 20 to 50 cm
Pour plats à paella de 20 à 50 cm Ø
Für Paellapfannen von 20 bis 50 cm Ø

Ref. 998.050

Para paelleras de 36 a 70 cm Ø
For paella pans from Ø 36 to 70 cm
Pour plats à paella de 36 à 70 cm Ø
Für Paellapfannen von 36 bis 70 cm Ø

Ref. 998.070

Para paelleras de 36 a 90 cm Ø
For paella pans from Ø 36 to 90 cm
Pour plats à paella de 36 à 90 cm Ø
Für Paellapfannen von 36 bis 90 cm Ø

999 Trípode paellero / Base for burner / Pied pour brûleur / Dreifussständer für Gasbrenner

REF	€	U
999.000	39,60	1

Plegable apto para paelleros de 2 y 3 círculos
Folding valid for 2 and 3 circles burners
Pliant valable pour brûleurs de 2 et 3 cercles /
Klappbar geeignet für 2 bis 3 Kreisgasbrenner

23005 Quemador GAS industrial / Industrial gas burner / Brûleur à gaz industriel / Industriegasbrenner

REF	Kw	€	U
23005	8,5	60,75	1

Gas natural y propano /
Natural gas and propane /
Gaz naturel et propane /
Erd- und Propangas

COOKWARE PASSION & MEDITERRANEAN

NOTHING LESS,
NOTHING MORE



SelfCookingCenter
whirlpool

0 1



269 Rustidera / Rost Pan / Plaque à rôtir / Bräter

INOX - ST/STEEL
EDELSTAHL
18/10



REF	cm	H cm	Lts	€	U
269.035	35 x 27	5,5	5,00	72,50	1

309 Rustidera asas móviles /Roast pan falling handles /
Plaque à rôtir anses tombantes /
Bräter mit beweglichen Griffen

INOX - ST/STEEL
EDELSTAHL
18/10



REF	cm (int)	cm (ext)	H cm	Lts	€	U
309.035	35 x 27	37,5 x 29,5	5,5	5,20	71,80	1
309.040	40 x 30	43 x 33	6,5	6,50	84,80	1
309.050	50 x 35	54 x 39	7,0	11,00	107,50	1
309.060	60 x 40	64 x 44	9,0	19,00	130,90	1
309.070	70 x 45	74 x 49	10,0	27,00	152,00	1

1145 Rustidera aluminio presentación antiadherente /
Non-stick presentation aluminium roast pan /
Plaque à rôtir anti-adhésive présentation /
Bräter Antihaft Aluminiumpräsentation

ALUMINIO /
ALUMINIUM



REF	cm	H cm	Lts	€	U
114.540	40 x 30	6,5	6,30	76,50	1
114.545	45 x 32	6,5	7,60	82,65	1
114.550	50 x 35	7,0	10,80	93,85	1

122 Rustidera antiadherente asas móviles /
Non-stick roast pan falling handles /
Plaque à rôtir anti-adhésive anses tombantes /
Bräter mit beweglichen Griffen

ALUMINIO /
ALUMINIUM



REF	cm	H cm	Lts	€	U
122.040	40 x 30	6,5	6,30	54,20	1
122.050	50 x 35	7,0	10,80	67,70	1
122.060	60 x 40	9,0	19,00	97,20	1

114 Rustidera asas fijas /
Roast pan fixed handles /
Plaque à rôtir avec poignées fixes /
Bräter mit festen Griffen

ALUMINIO /
ALUMINIUM



REF	cm	H cm	Lts	€	U
114.040	40 x 30	6,5	6,30	38,35	1
114.045	45 x 32	6,5	7,60	41,90	1
114.050	50 x 35	7,0	10,80	53,90	1
114.060	60 x 40	9,0	19,00	66,70	1
114.070	70 x 45	10,0	27,70	81,90	1

113 Rustidera asas móviles /
Roast pan falling handles /
Plaque à rôtir anses tombantes /
Bräter mit beweglichen Griffen

ALUMINIO /
ALUMINIUM



REF	cm	H cm	Lts	€	U
113.030	30 x 23	5,0	3,00	27,60	1
113.035	35 x 27	5,5	5,00	32,95	1
113.040	40 x 30	6,5	6,30	38,35	1
113.045	45 x 32	6,5	7,60	41,90	1
113.050	50 x 35	7,0	10,80	53,90	1
113.055	55 x 40	8,0	15,50	59,85	1
113.060	60 x 40	9,0	19,00	66,70	1
113.065	65 x 45	10,0	25,70	76,05	1
113.070	70 x 45	10,0	27,70	79,90	1

BANDEJAS GASTRONORM / GASTRONORM TRAYS / PLAQUES GASTRONORME / GASTRONOMTABLETTS

3180

Bandeja gastronorm /
Gastronorm sheet /
Plaque gastronorme /
Gastronormtablett

INOX - ST/STEEL
EDELSTAHL
18/10

Grosor: 1 mm
Thickness: 1 mm
Épaisseur: 1 mm
Dicke: 1 mm



REF	TIPO / TYPE	mm	H mm	€	U
318.005	1/1	530 x 325	8,0	24,50	1

3182

Bandeja honda gastronorm /
Deep gastronorm sheet /
Plaque gastronorme fonde /
Tiefes Gastronormtablett

INOX - ST/STEEL
EDELSTAHL
18/10

Grosor: 0,7 mm
Thickness: 0,7 mm
Épaisseur: 0,7 mm
Dicke: 0,7 mm



REF	TIPO / TYPE	mm	H mm	€	U
318.211	1/1	530 x 325	20,0	20,85	1

1323

Bandeja GN antiadherente /
Non-stick GN pan tray /
Plaque GN anti-adhésive /
Antihaft Tablett GN

ALUMINIO /
ALUMINIUM

Grosor = 3 mm
Thickness = 3 mm
Épaisseur = 3 mm
Dicke: 3 mm



REF	TIPO / TYPE	H mm	Lts	€	U
132.365	1/1	65,0	7,90	87,80	1

1325

Bandeja multiunidades /
Multi-units tray /
Plaque multi-unités /
Multieinheiten Tablett

ALUMINIO /
ALUMINIUM

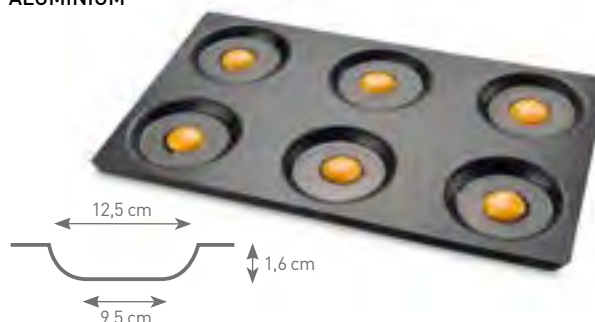

REF	TIPO / TYPE	mm	€	U
132.560	1/1	530 x 325	64,20	1

BANDEJAS PASTELERÍA / PASTRY TRAYS / PLAQUES À PÂTISSERIE / PATISSERIETABLETT

318

Bandeja pastelería / Baking sheet /
Plaque à pâtisserie / Patisserietablett

INOX - ST/STEEL
EDELSTAHL
18/10

Grosor: 1 mm
Thickness: 1 mm
Épaisseur: 1 mm
Dicke: 1 mm



REF	mm	H mm	€	U
318.040	400 x 300	12,0	21,30	1
318.060	600 x 400	12,0	44,70	1

779

Bandeja pastelería / Baking sheet /
Plaque à pâtisserie / Patisserietablett

INOX - ST/STEEL
EDELSTAHL
18/10

Grosor: 0,7 mm
Thickness: 0,7 mm
Épaisseur: 0,7 mm
Dicke: 0,7 mm



REF	mm	H mm	€	U
779.017	255 x 175	10,0	10,05	1
779.021	275 x 210	10,0	12,05	1
779.026	300 x 260	10,0	13,50	1
779.060	600 x 200	10,0	18,65	1

777

Marcos para bandejas es cuadradas /
Rectangle for bakin sheets /
Rectangle pour plaques /
Rahmen für rechteckige Backbleche

INOX - ST/STEEL
EDELSTAHL
18/10



Marcos adaptables a las bandejas es cuadradas de la ref. 778, 1232 y 1322
Rectangles that are adptable to the baking sheets of ref. 778, 1232 and 1322
Rectangles pour adapter aux plaques inox des réfs. 778m 1232 et 1322
Rahmen geeignet für rechteckige Backbleche Art.Nr. 778, 1232 und 1322

REF	mm	H mm	€	U
777.540	395 x 295	50,0	19,15	1
777.548	475 x 305	50,0	20,35	1
777.560	595 x 395	50,0	29,50	1

778

Bandeja es cuadrada /
Tray for confectionery /
Plaque à pâtisserie /
Rechteckiges Backblech

INOX - ST/STEEL
EDELSTAHL
18/10



REF	mm	H mm	€	U
778.040	400 x 300	10,0	22,50	1
778.048	480 x 310	10,0	23,30	1
778.060	600 x 400	10,0	41,95	1

123

Bandeja para pastelería /
Tray for confectionery /
Plaque à pâtisserie /
Patisserietablett

ALUMINIO /
ALUMINIUM



REF	mm	H mm	€	U
123.040	400 x 300	12,0	18,10	1
123.060	600 x 400	12,0	27,50	1

1231

Bandeja perforada para pastelería /
Perforated tray for confectionery /
Plaque à pâtisserie perforée /
Gelochtes Patisserietablett

ALUMINIO /
ALUMINIUM



REF	mm	H mm	€	U
123.140	400 x 300	12,0	21,40	1
123.160	600 x 400	12,0	31,50	1

1232

Bandeja para pastelería /
Tray for confectionery /
Plaque à pâtisserie /
Patisserietablett

ALUMINIO /
ALUMINIUM



REF	mm	H mm	€	U
123.240	400 x 300	12,0	23,30	1
123.260	600 x 400	12,0	32,60	1

132

Bandeja pastelería antiadherente /
Non-stick tray for confectionery /
Plaque à pâtisserie anti-adhésive /
Antihaft Patisserietablett

ALUMINIO /
ALUMINIUM



REF	mm	H mm	€	U
132.040	400 x 300	12,0	25,30	1
132.060	600 x 400	12,0	36,20	1

BANDEJAS PASTELERÍA / PASTRY TRAYS / PLAQUES À PÂTISSERIE / PATISSERIETABLETT

1321

Bandeja pastelería antiadherente perforada /
Perforated non-stick tray for confectionery /
Plaque à pâtisserie anti-adhésive perforée /
Antihaft Patisserietablett gelocht

ALUMINIO /
ALUMINIUM

REF	mm	H mm	€	U
132.140	400 x 300	12,0	27,70	1
132.160	600 x 400	12,0	42,90	1

1322

Bandeja pastelería antiadherente /
Non-stick tray for confectionery /
Plaque à pâtisserie anti-adhésive /
Antihaft Patisserietablett

ALUMINIO /
ALUMINIUM

REF	mm	H mm	€	U
132.240	400 x 300	12,0	35,90	1
132.260	600 x 400	12,0	48,60	1

REJILLAS / GRIDS / GRILLES / ROSTE

9091

Rejilla gastronorm acero inox / St/Steel gastronorm grid /
Grille acier inoxydable gastronorm / Rostfreier Gastronormrost



REF	TIPO / TYPE	mm	N. TRAVESAÑOS / N. CROSS-BARS / N. TRAVERSES / N. QUERSTÄBE	Ø mm TRAVESAÑOS / Ø mm CROSS-BARS / Ø mm TRAVERSES / Ø mm QUERSTÄBE	N. VARILLAS / N. WIRES / N. FILS / N. STÄBE	Ø mm VARILLAS / Ø mm WIRES / Ø mm FILS / Ø mm STÄBE	€	U
909.121	2/1	650 x 530	3	5	32	2	27,45	1
909.111	1/1	530 x 325	2	5	20	2	20,25	1

9092

Rejilla gastronorm con Rilsan blanco / White rilsan steel gastronorm grid /
Grille gastronorm en acier et rilsan blanc / Gastronormrost mit weissem Rilsan



REF	TIPO / TYPE	mm	N. TRAVESAÑOS / N. CROSS-BARS / N. TRAVERSES / N. QUERSTÄBE	Ø mm TRAVESAÑOS / Ø mm CROSS-BARS / Ø mm TRAVERSES / Ø mm QUERSTÄBE	N. VARILLAS / N. WIRES / N. FILS / N. STÄBE	Ø mm VARILLAS / Ø mm WIRES / Ø mm FILS / Ø mm STÄBE	€	U
909.221	2/1	650 x 530	3	5	22	5	25,50	1
909.211	1/1	530 x 325	2	5	13	5	15,40	1

9093

Rejilla pastelería acero inox / St/Steel pastry grid /
Grille pâtisserie acier inoxydable / Rostfreier Patisserierost



REF	mm	N. TRAVESAÑOS / N. CROSS-BARS / N. TRAVERSES / N. QUERSTÄBE	Ø mm TRAVESAÑOS / Ø mm CROSS-BARS / Ø mm TRAVERSES / Ø mm QUERSTÄBE	N. VARILLAS / N. WIRES / N. FILS / N. STÄBE	Ø mm VARILLAS / Ø mm WIRES / Ø mm FILS / Ø mm STÄBE	€	U
909.340	400 x 300	2	5	22	2	16,20	1
909.360	600 x 400	3	5	29	2	20,65	1

9094

Rejilla pastelería reforzada acero inox / St/Steel reinforced pastry grid /
Grille pâtisserie acier inoxydable renforcée / Rostfreier Patisserierost verstärkt



REF	mm	N. TRAVESAÑOS / N. CROSS-BARS / N. TRAVERSES / N. QUERSTÄBE	Ø mm TRAVESAÑOS / Ø mm CROSS-BARS / Ø mm TRAVERSES / Ø mm QUERSTÄBE	N. VARILLAS / N. WIRES / N. FILS / N. STÄBE	Ø mm VARILLAS / Ø mm WIRES / Ø mm FILS / Ø mm STÄBE	€	U
909.460	600 x 400	2	6	24	3	29,70	1

705 Molde hondo pizza antiadherente / Non-stick deep pizza mould /
Moule haute pizza anti-adhésif / Tiefes Antihaft Pizzablech



REF	Ø cm	H cm	€	U
705.024	24	2,5	8,50	6
705.028	28	2,5	10,65	6
705.032	32	2,5	12,75	6

736 Molde pizza antiadherente perforado /
Perforated non-stick pizza mould /
Moule à pizza anti-adhésif perforé /
Gelochtes Antihaft Pizzablech



REF	Ø cm	H cm	€	U
736.030	30	1,3	26,45	6
736.034	34	1,3	31,70	6

929 Base pizza aluminio /
Aluminium pizza pan /
Plaque à pizza aluminium /
Aluminium Pizzablech



REF	Ø cm	€	U
929.025	25	6,90	1
929.028	28	8,40	1
929.030	30	9,40	1
929.036	36	11,85	1
929.040	40	14,90	1

949 Base rejilla aluminio antiadherente para pizza /
Non-stick aluminium pizza screen /
Base maillée aluminium anti-adhésive pour pizza /
Antihaft Pizzagitter Aluminium



REF	Ø cm	€	U
949.025	25,5	5,15	1
949.030	30,5	6,40	1
949.035	35,5	7,90	1
949.040	40,0	10,85	1

963 Base rejilla aluminio para pizza /
Aluminium pizza screen /
Base maillée aluminium pour pizza /
Pizzagitter Aluminium



REF	Ø cm	€	U
963.025	25	4,65	1
963.030	30,5	5,45	1
963.035	35,5	6,70	1
963.040	40,0	8,70	1

977 Soporte para bases pizza 15 niveles /
Pizza pan rack 15 levels /
Support pour plaques à pizza 15 niveaux /
Ständer für Pizzableche 15 Ebenen



REF	cm	H cm	€	U
977.015	30,5 x 30,5	70,0	66,65	1

Recomendado para Ref. 929 hasta Ø36 cm
Suitable for item Code 929 up to Ø36 cm
Recommandé pour Réf. 929 jusqu'au Ø36 cm
Empfohlen für Ref. 929 bis Ø36 cm

972 Papel siliconado /
Siliconized baking release papers /
Papier siliconé anti-adhésif /
Backpapier aus Silikon



REF	mm	unidades / unit	€	U
972.060	600 x 400	500	60,60	1

Caja de 500 unidades. Siliconado por las dos caras. Múltiples usos.
Gramaje 41 gr/m2. Resistente a la grasa. Color blanco.
Set of 500 units both sides siliconized. Multiple uses.
Grammage 41 gr/m2. Greaseproof. Bleached.
Boîte de 500 unités. Deux faces siliconées. Multiples utilisations.
Gramage 41 gr/m2. Résistant à la graisse. Couleur blanc.
Kiste mit 500 Stück. Beidseitig mit Silikon. Mehrfacher Gebrauch.
Gewicht 41 gr/m2. Resistent gegen Fett. Weiss.

833 Tapete de silicona / non-stick silicone mat /
Toile de cuisson / Silikonmatte

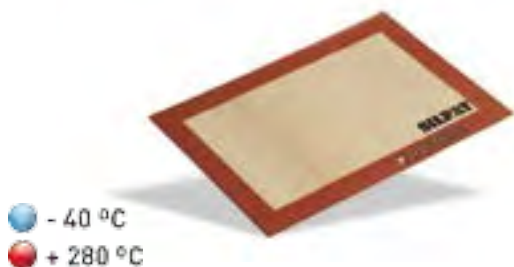

REF	mm	€	U
833.001	520 x 315	26,15	1
833.002	585 x 385	33,25	1
833.003	400 x 300	23,40	1

607 Pinza fuente horno / roast pan tong /
Pince pour plaque à rôtir / Ofenblechzange



REF	L cm	€	U
607.000	19	9,40	1

948 Pala pizza de aluminio / aluminium pizza peel /
Pelle à enfourner en aluminium / Aluminium Pizzaschaufel



REF	PALA / PEEL / PELLE / SCHAUFEL CM	L cm	€	U
948.066	31 x 35	66	28,75	1
948.090	31 x 35	90	31,00	1
948.132	31 x 35	132	33,25	1
948.163	31 x 35	163	36,45	1



3011 Cacillo monobloc / One piece ladle / Louche monobloc / Monoblock Schöpflöffel

Capacidad marcada en el mango /
Capacity marked on the handle /
Capacité marqué à la queue /
Volumenangabe am Griff markiert



REF	Ø cm	L cm	Lts	€	U
301.165	6,5	31	0,07	8,20	12
301.108	8	32	0,13	9,15	12
301.109	9	33	0,20	10,10	12
301.110	10	37	0,25	11,05	6
301.112	12	42	0,45	12,90	6
301.114	14	43	0,75	16,50	6
301.116	16	45	1,00	17,30	6
301.118	18	48	1,50	27,10	6

3012 Cacillo monobloc económico / Economical one piece ladle / Louche monobloc économique / Monoblock Schöpflöffel ökonomisch

Capacidad marcada en el mango /
Capacity marked on the handle /
Capacité marqué à la queue /
Volumenangabe am Griff markiert



REF	Ø cm	L cm	Lts	€	U
301.206	6	27	0,05	5,15	10
301.208	8	31	0,12	7,05	10
301.210	10	33	0,25	8,70	10
301.212	12	36	0,42	10,30	10
301.214	14	39	0,75	12,80	10
301.216	16	43	1,20	15,65	10

392 Cacillo para salsas con 2 picos laterales / One piece sauce ladle with 2 spouts / Cuillère à sauces monobloc avec 2 becs verseurs / Schöpflöffel für Sossen mit 2 seitlichen Ausgüssen

Capacidad marcada en el mango /
Capacity marked on the handle /
Capacité marqué à la queue /
Volumenangabe am Griff markiert



REF	Ø cm	L cm	Lts	€	U
392.065	6,5	31	0,08	11,95	10

30326 Cacillo monobloc mango corto / One piece ladle short handle / Louche monobloc manche court / Monoblock Schöpflöffel kurzer Stiel

Capacidad marcada en el mango /
Capacity marked on the handle /
Capacité marqué à la queue /
Volumenangabe am Griff markiert



REF	Ø cm	L cm	Lts	€	U
303.265	6,5	22	0,07	10,10	10

396 Cacillo monobloc con agujeros / Perforated one piece ladle / Louche monobloc perforée / Gelochter Monoblock Schöpflöffel

REF	Ø cm	L cm	€	U
396.009	9	33	13,40	10
396.010	10	37	14,35	10
396.012	12	42	16,05	10

3021 Espumadera monobloc / One piece skimmer / Écumoire monobloc / Schaumlöffel Monoblock



REF	Ø cm	L cm	€	U
302.108	8	29	7,80	10
302.110	10	32	9,25	10
302.112	12	35	9,85	10
302.114	14	37	12,60	10
302.116	16	44	13,75	5
302.118	18	44	21,50	5
302.120	20	47	26,45	5

3022 Espumadera monobloc económica / Economical one piece skimmer / Écumoire monobloc économique / Schaumlöffel Monoblock ökonomisch



REF	Ø cm	L cm	€	U
302.210	10	33	7,45	10
302.212	12	36	8,50	10
302.214	14	39	10,65	10
302.216	16	42	11,95	10

3141 Espátula monobloc sin perforar / One piece spatula / Spatule monobloc / Pfannenwender Monoblock



REF	cm	L cm	€	U
314.110	10	36	10,80	5
314.112	12	39	11,55	5

3142 Espátula monobloc perforada / One piece perforated spatula / Spatule monobloc perforée / Gelochter Pfannenwender Monoblock



REF	cm	L cm	€	U
314.210	10	36	11,20	5
314.212	12	39	11,75	5

3143 Pala pescado monobloc / One piece fish spatula / Pelle à poisson monobloc / Fischwender Monoblock



REF	cm	L cm	€	U
314.300	16 x 12	42	14,80	5

376 Cuchara monobloc profesional /
Professional one piece spoon /
Cuillère monobloc professionnelle /
Professioneller Löffel Monoblock



REF	L cm	€	U
376.037	37	10,55	10

3761 Cuchara honda monobloc profesional /
Professional one piece deep spoon /
Cuillère fonde monobloc professionnelle /
Tiefer professioneller Löffel Monoblock



REF	L cm	€	U
376.137	37	10,55	10

377 Cuchara perforada monobloc profesional /
Professional one piece perforated spoon /
Cuillère perforée monobloc professionnelle /
Gelochter professioneller Löffel Monoblock



REF	L cm	€	U
377.037	37	10,75	10

3771 Cuchara honda monobloc profesional perforada /
Professional one piece perforated deep spoon /
Cuillère fonde monobloc professionnelle perforée /
Tiefer gelochter professioneller Löffel Monoblock



REF	L cm	€	U
377.137	37	10,75	10

395 Cuchara oblicua monobloc /
One piece crosswire spoon /
Cuillère oblique monobloc /
Sossenlöffel Monoblock



REF	L cm	€	U
395.038	38	11,35	10

3972 Tenedor monobloc /
One piece meat fork /
Fourchette monobloc /
Fleischgabel Monoblock



REF	L cm	€	U
397.247	47	18,40	10

2 púas / 2 prongs / 2 dents / 2 Zinken

3973 Tenedor monobloc / One piece meat fork /
Fourchette monobloc / Fleischgabel Monoblock



REF	L cm	€	U
397.347	47	19,20	10

3 púas / 3 prongs / 3 dents / 3 Zinken

315 Espumadera de alambre / Mesh skimmer /
Écumoire à friture / Drahtschaumlöffel



REF	Ø cm	L cm	€	U
315.010	10	40	10,40	10
315.012	12	43	13,75	10
315.015	15	50	18,90	10
315.017	17	54	22,25	10
315.020	20	61,5	27,20	10

94101 Araña / Wire skimmer /
Araignée / Schaumlöffel



REF	Ø cm	L cm	€	U
941.013	13	47,5	9,35	10
941.015	15	49,5	10,40	10
941.018	18	52,5	11,45	10
941.020	20	54,5	12,50	10
941.022	22	67	13,80	5
941.024	24	69	14,75	5
941.028	28	69	16,60	5

955 Espumadera malla fina / Mesh skimmer /
Écumoire maillée / Feiner Drahtschaumlöffel



REF	Ø cm	L cm	€	U
955.010	10	40	6,75	10
955.012	12	43	9,00	10
955.015	15	50	10,75	10
955.017	17	54	16,15	10
955.020	20	61	18,50	10

Detalle de la malla a escala real
Detail of the sieve at real scale
Détail de la maille à échelle réelle
Detail Maschen in realer Größe

394 Molde nido / Bird nest mould /
Moule à nid / Vogelnestform

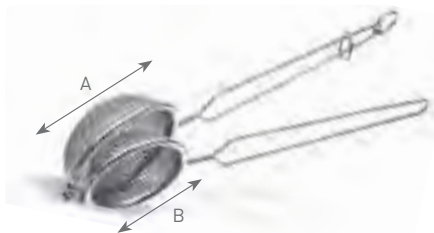

REF	Ø A cm	Ø B cm	€	U
394.008	10	8	17,70	1
394.012	12	10	21,00	1

VER PRODUCTOS EN / SEE PRODUCTS ON /
VOIR PRODUITS EN PAGE / SIEHE PRODUKTE IN

Batidores / Whisks / Fouets / Rührbesen



P. 366

IDEA!

Pinzas ideales para emplatar y decorar
 Plating tongs for careful lifting, turning and decorating
 Pinces idéales pour la présentation et la décoration
 Ideale Zangen Zum Anrichten und Dekorieren

3434 Pinza chef precisión extra larga (fina) / Extra long fine tip straight tweezer (narrow) / Pince du chef précision extra long (étroite) / Extra lange Präzisionspinzette (schmal)

INOX - ST/STEEL
 EDELSTAHL
 18/10

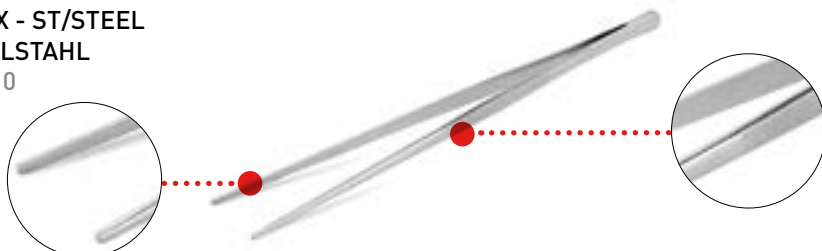

REF	L cm	€	U
343.400	30	10,80	1

3435 Pinza chef precisión extra larga (ancha) / Extra long fine tip straight tweezer (wide) / Pince du chef précision extra long (large) / Extra lange Präzisionspinzette (breit)

INOX - ST/STEEL
 EDELSTAHL
 18/10

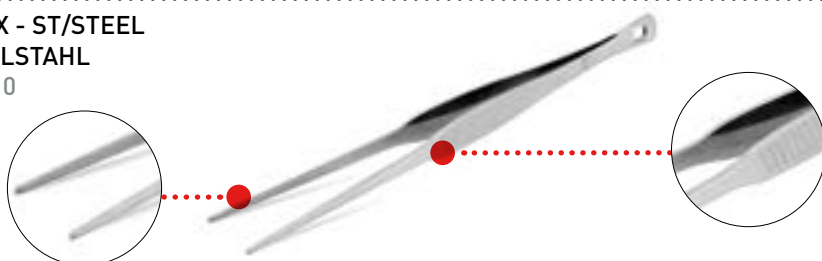

REF	L cm	€	U
343.500	30	13,15	1

3436 Pinza chef precisión / Fine tip straight tweezer / Pince du chef précision / Präzisionspinzette

INOX - ST/STEEL
 EDELSTAHL
 18/10

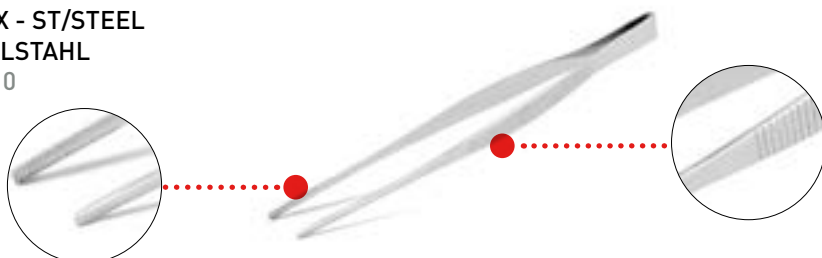

REF	L cm	€	U
343.600	21	5,80	1

3437 Pinza Chef precisión pequeña / Small fine tip straight tweezer / Pince du chef précision petite / Kleine Präzisionspinzette

INOX - ST/STEEL
 EDELSTAHL
 18/10

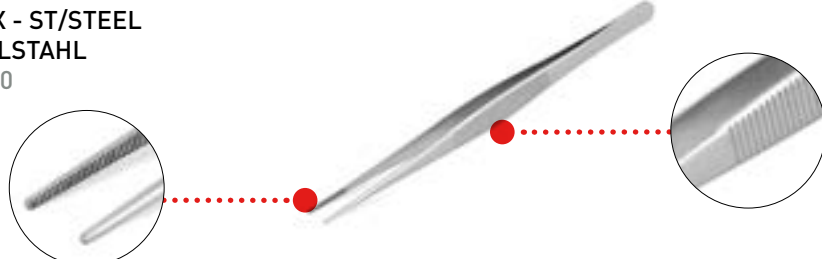

REF	L cm	€	U
343.700	16	3,65	1

3438 Pinza sushi / Sushi tweezer / Pince à sushi / Sushipinzette

INOX - ST/STEEL
 EDELSTAHL
 18/10



REF	L cm	€	U
343.800	16	4,70	1

358 INOX Pinza buffet / utility tong / Pince buffet / Buffetzange



REF	L cm	€	U
358.024	24	4,20	12
358.029	29,5	4,85	12
358.040	40	6,25	12

358 COLOR Pinza buffet inox mango color / st/steel utility tong coloured handle / Pince buffet inox manche couleur / Rostfreie Buffetzange mit farbigem Griff



REF	L cm	BLANCO / WHITE / BLANC / WEISS	ROJO / RED / ROUGE / ROT	AZUL / BLUE / BLEU / BLAU	AMARILLO / YELLOW / JAUNE / GELB	VERDE / GREEN / VERT / GRÜN	MARRÓN / BROWN / MARRON / BRAUN	NEGRO / BLACK / NOIR / SCHWARZ	€	U
358	24	1	2	3	4	5	6	7	6,25	1
358	30	1	2	3	4	5	6	7	6,85	1
358	40	1	2	3	4	5	6	7	8,70	1

Ref : 358 + L + Color / Colour / Couleur / Farbe

Fabricadas en acero inoxidable monobloc.
Mango con revestimiento PVC aislante para una mejor sujeción.
Made of one piece St/Steel. Handle with PVC coating for a better grip and insulation.
Fabriquées en acier inoxydable monobloc.
Manche avec revêtement PVC pour une meilleure préhension et isolation.
Hergestellt aus rostfreien Monoblock.
Griff mit PVC Beschichtung für bessere Griffigkeit und Isolierung.

620 Pala chips / chip bagger / Pelle à frites / Frittenschaufel



REF	cm	€	U
620.001	23 x 21	20,55	1

Mano derecha
Right hand
Main droite
Rechtshändig

621 Pala chips abs / abs chip bagger / Pelle à frites en abs / Frittenschaufel ABS

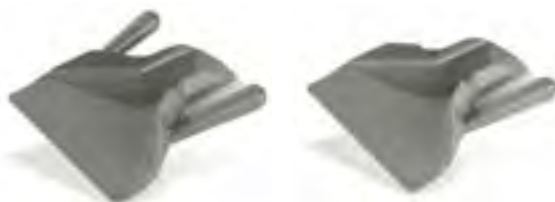

REF	cm	€	U
621.000	23 x 21	5,35	1
621.001	23 x 21	5,05	1

Ref. 621.000 (dual)

Ref. 621.001
(mano derecha / right hand / Main droite / rechtshändig)

MANGO ABS / ABS HANDLE / MANCHE EN ABS / ABS GRIFF

381 Espátula triangular "pintor" /
Cleaning spatula /
Palette triangle /
Dreieckige Reinigungsspachtel



REF	cm	L cm	€	U
381.008	8	24,5	4,95	12
381.010	10	25	5,45	12

382 Pala bar /
Spatula /
Palette /
Spachtel



REF	cm	L cm	€	U
382.000	7 x 16	29	7,15	12

383 Pala fast-food y pescado /
Fast-food and fish turner /
Palette fast-food et poisson /
Fast-Food und Fischeischaufel

Flexible /
Flexibel

REF	cm	L cm	€	U
383.000	7,3 x 25	38	8,40	12

384 Pala fast-food perforada /
perforated fast-food turner /
Palette fast-food perforée /
Fast-Food Schaufel gelocht

Flexible /
Flexibel

REF	cm	L cm	€	U
384.000	7,3 x 25	38	8,50	12

386 Rasqueta /
Dough scraper /
Raclette /
Schaber



REF	cm	€	U
386.000	15 x 7,5	4,50	12

380 Ruleta cortapizzas /
Pizza wheel /
Roulette à pizza /
Pizzaschneider



REF	cm	L cm	€	U
380.000	10	23,5	5,35	12

385 Espátula pastelera /
Baker spatula /
Palette /
Kuchenspachtel



REF	PALA / PEEL / PELLE / BLATT cm	L cm	€	U
385.020	20,5	34	6,15	12
385.026	26	39	6,75	12
385.030	30	43,5	7,15	12

3855 Espátula para untar /
Butter spreader /
Couteau à beurre /
Aufstrichspachtel



REF	PALA / PEEL / PELLE / BLATT cm	L cm	€	U
385.500	10,4 x 3,4	23	2,10	1

872 Pala pasteles /
Cake server /
Pelle à gâteau /
Keksschaufel

Sin sierra /
Without saw /
Sans scie /
Ohne säge

REF	L cm	€	U
872.000	28	3,40	12

37501 Rasqueta triangular. Mango madera / Triangle dough scraper. Wood handle /
Raclette triangle. Manche en bois / Dreieckiger Schaber. Holzgriff



REF	PALA / PEEL / PELLE / BLATT cm	L cm	€	U
375.010	10,2 x 10	21	4,40	12

37502 Rasqueta semicírculo. Mango madera / Semicircle dough scraper. Wood handle /
Raclette semicercle. Manche en bois / Halbrunder Schaber. Holzgriff



REF	PALA / PEEL / PELLE / BLATT cm	L cm	€	U
375.020	10,2 x 10,5	24,2	4,40	12

37506 Pala bar. Mango madera / Spatula. Wood handle /
Palette. Manche en bois / Schaufel. Holzgriff



REF	PALA / PEEL / PELLE / BLATT cm	L cm	€	U
375.061	15,2 x 7,6	29	4,25	12
375.062	17,8 x 7,6	31	5,10	12
375.063	25,4 x 10,2	40,1	7,50	12

37504 Pala fast-food. Flexible. Mango madera / Fast-food turner. Flexible. Wood handle /
Palette fast-food. Flexible. Manche en bois / Fast-Food Schaufel. Holzgriff



REF	PALA / PEEL / PELLE / BLATT cm	L cm	€	U
375.041	25,4 x 7,6	37	5,15	12
375.042	25,4 x 7,6	53	6,80	12

37505 Pala fast-food perforada. Flexible. Mango madera / Perforated fast-food turner. Flexible. Wood handle /
palette fast-food perforée. Flexible. Manche en bois / Gelochte Fast-Food Schaufel. Holzgriff



REF	PALA / PEEL / PELLE / BLATT cm	L cm	€	U
375.050	25,4 x 7,6	37	5,15	12

37507 Rasqueta rectangular. Mango madera / Rectangular dough scraper. Wood handle /
Raclette rectangle. Manche en bois / Rechteckiger Schaber. Holzgriff



REF	PALA / PEEL / PELLE / BLATT cm	L cm	€	U
375.070	15,2 x 7,6	11,3	3,20	12

37508 Sierra. Mango madera / Saw. Wood handle /
Sierra. Manche en bois / Säge. Holzgriff



REF	PALA / PEEL / PELLE / BLATT cm	L cm	€	U
375.080	18,5 x 4,8	19 x 13	5,15	12

37509 Tenedor. Mango madera / Meat fork. Wood handle /
Fourchette. Manche en bois / Fleischgabel. Holzgriff



REF	PALA / PEEL / PELLE / BLATT cm	L cm	€	U
375.090	15,5 x 2,2 x 0,2	53,3	4,10	12

37510 Pala pasteles. Mango madera / Cake server. Wood handle /
Pelle à gâteau. Manche en bois / Keksschaufel. Holzgriff



REF	PALA / PEEL / PELLE / BLATT cm	L cm	€	U
375.100	15,2 x 5,1	26	2,40	12

37511 Espátula para untar. Mango madera / Butter spreader. Wood handle /
Couteau à beurre. Manche en bois / Aufstrichspachtel. Holzgriff



REF	PALA / PEEL / PELLE / BLATT cm	L cm	€	U
375.110	10,2 x 3,3	19,7	1,55	12

GUÍA SELECCIÓN RALLADORES / GRATERS SELECTION GUIDE / GUIDE SÉLECTION RAPÊS / AUSWAHLÜBERSICHT REIBEN

	DOBLE NAVAJA / RIBON / TRANCHANTS / DOPPELKLINGEN	TIRAS LARGAS / LARGE SHAVER / LARGE COUPE / LANGE STREIFEN	FINO / FINE / FIN / FEIN	MEDIO / MEDIUM / MOYEN / MITTEL	GRUESO / EXTRA COARSE / GROS GRAINS / GROB	DUAL / DUAL / DOUBLE / DOPPEL
ZANAHORIA / CARROT / CAROTTE / KAROTTEN	✓	✓				✓
CEBOLLA / ONION / OIGNON / ZWIEBEL	✓			✓		✓
AJO / GARLIC / AIL / KNOBLAUCH			✓			
CHOCOLATE SCHOKOLADE	✓		✓	✓	✓	✓
CITRICOS / CITRUS / CITRON / ZITRONEN		✓	✓	✓		
PATATA / POTATO / POMME DE TERRE / KARTOFFEL	✓	✓				
MANZANA / APPLE / POMME / APFEL	✓	✓			✓	
QUESO DURO / HARD CHEESE / FROMAGE / HARTKÄSE	✓		✓	✓	✓	✓
QUESO BLANDO / SOFT CHEESE / FROMAGE / WEICHKÄSE	✓				✓	
NUEZ / NUT / NOIX / NÜSSE			✓	✓		✓
PIMIENTO / PEPPER / POIVRON / PFEFFER			✓	✓		✓
TOMATE / TOMATO / TOMATO / TOMATEN				✓	✓	

328 Rallador / Grater / Râpe / Reibe

INOX - ST/STEEL
ROSTFREIER STAHL



Ref. 328.600

REF	CARAS / SIDES / FACES / SEITEN	cm	H cm	€	U
328.020	4	9 x 6,5	20,8	6,45	12
328.023	4	10,5 x 8	23,3	7,90	12
328.600	6	14,5 x 11	22,0	16,25	12

391 Rallador nuez moscada de acero inox / St/Steel nutmeg grater /
Râpe à muscade en acier inox / Rostfreie Muskatnussreibe



REF	€	U
391.000	6,05	12

3221 Rallador acero inoxidable "slim" con mango / St/Steel "slim" grater with handle / Râpe inoxydable "slim" avec queue / Rostfreie Reibe "schmal" mit Griff

Ralladores de acero inoxidable. Mangos ergonómicos. Borde antideslizante
St/Steel graters. Ergonomic and soft touch handles. Non-slip rubber end
Râpes en acier inoxydable. Poignée ergonomique. Extrémité anti-dérapant
Rostfreie Reiben. Ergonomische Griffe. Antirutschrand.

REF	cm	€	U
322.101	39,5 x 3,5	11,30	1
322.102	39,5 x 3,5	11,30	1
322.103	39,5 x 3,5	11,30	1
322.104	39,5 x 3,5	11,30	1

IDEA!

ESPECIAL CÍTRICOS /
IDEAL CITRUS /
IDÉAL POUR AGRUMES /
IDEAL FÜR ZITRUSFRÜCHTE



REF. 322.104
Fino
Fine
Fin
Fein



REF. 322.101
Dual
Dual
Double
Doppel



REF. 322.102
Doble navaja
Ribon
Tranchants
Zwei Klingen



REF. 322.103
Medio
Medium
Moyen
Medium

3222 Rallador acero inoxidable "wide" con mango / St/Steel "wide" grater with handle / Râpe inoxydable "wide" avec queue / Rostfreie Reibe "breit" mit Griff

Ralladores de acero inoxidable. Mangos ergonómicos. Borde antideslizante
St/Steel graters. Ergonomic and soft touch handles. Non-slip rubber end
Râpes en acier inoxydable. Poignée ergonomique. Extrémité anti-dérapant
Rostfreie Reiben. Ergonomische Griffe. Antirutschrand.

REF	cm	€	U
322.201	31,5 x 7,3	11,50	1
322.202	31,5 x 7,3	11,50	1
322.203	31,5 x 7,3	11,50	1
322.204	31,5 x 7,3	11,50	1

IDEA!

ESPECIAL CÍTRICOS /
IDEAL CITRUS /
IDÉAL POUR AGRUMES /
IDEAL FÜR ZITRUSFRÜCHTE



REF. 322.204
Fino
Fine
Fin
Fein



REF. 322.201
Tiras largas
Large shaver
Large coupe
Lange Streifen



REF. 322.202
Doble navaja
Ribon
Tranchants
Zwei Klingen



REF. 322.203
Grueso
Extra coarse
Gros grains
Grob

374 Colador doble malla en acero inoxidable / St/Steel double mesh strainer /
Passoire double maille en acier inox / Doppelmaschiges Sieb rostfrei

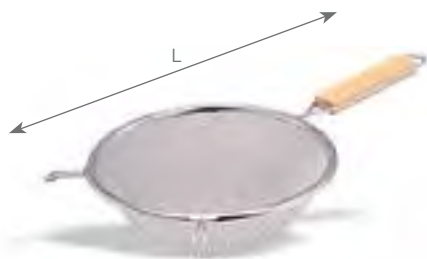

REF	Ø cm	L cm	€	U
374.013	13	30	5,20	1
374.015	15	32	6,60	1
374.018	18	34	7,35	1
374.020	20	38	8,30	1
374.026	26	58,5	22,70	1

375 Colador doble malla en acero inoxidable. Reforzado / St/Steel double mesh strainer. Reinforced /
Passoire double maille en acier inox. Renforcé / Doppelmaschiges Sieb rostfrei und verstärkt

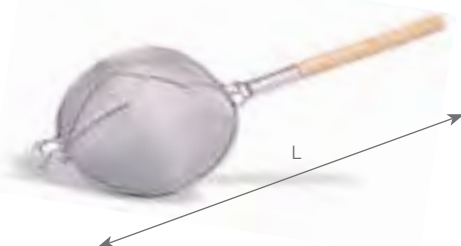

REF	Ø cm	L cm	€	U
375.030	30	79	73,20	1
375.035	35	86,5	78,70	1

324 Colador 1/2 bola reforzado en acero inox / St/Steel reinforced 1/2 ball colander /
Passoire ronde renforcé en acier inox / Halbkugeliges Sieb rostfrei und verstärkt



REF	Ø cm	L cm	€	U
324.013	13	36	19,10	12
324.016	16	40	23,30	12
324.019	19	42,5	29,95	12
324.022	22	49	34,95	12
324.025	25	55,5	43,25	12

348 Colador cónico en acero inoxidable / St/Steel conical strainer /
Passoire conique en acier inox / Konisches Sieb rostfrei und verstärkt



REF	Ø cm	L cm	€	U
348.008	8	22,5	5,45	1
348.010	10	24,5	7,15	1
348.012	12	31,5	9,35	1
348.015	15	35	11,45	1
348.018	18	40,5	15,45	1

325 Colador media bola en acero inox / St/Steel hemispherical strainer /
Passoire demi-sphérique en acier inox / Halbrundes Sieb rostfrei



REF	Ø cm	L cm	€	U
325.008	8	22,5	4,85	1
325.010	10	25,2	7,05	1
325.012	12	32,5	9,00	1
325.015	15	40,2	11,75	1
325.018	18	42,5	14,70	1
325.020	20	44,5	21,00	1

303 Colador chino / Conical colander / Chinois / Spitzsieb

REF	Ø cm	€	U
303.016	16	16,35	1
303.018	18	16,90	1
303.020	20	17,50	1
303.022	22	20,25	1
303.024	24	21,75	1
303.026	26	22,65	1

347 Colador chino con malla / Conical colander with wire gauze / Chinois à gaze / Spitzsieb mit Maschen

REF	Ø cm	€	U
347.020	20	27,70	1
347.024	24	35,25	1

970 Soporte para chino o embudo / Stand for chinese colander or funnel / Support pour chinois ou entonnoir / Ständer für Spitzsieb und Trichter

REF	Ø cm	H cm	€	U
970.000	16	19	23,50	1

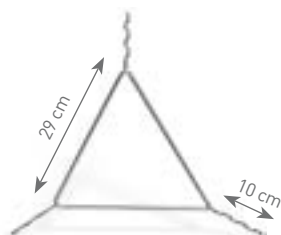
3032 Triángulo / Triangle / Triangle / Dreieck

REF	L cm	€	U
303.200	29	13,00	1

Triángulo equilátero
Equilateral triangle
Triangle équilatéral
Gleichseitiges Dreieck

373 Colador bayeta / Cotton strainer / Passe-bouillon / Textilsieb

REF	Ø cm	€	U
373.020	20	24,55	6
373.024	24	30,80	6
373.028	28	49,35	6

Acero inoxidable y algodón
St/Steel and cotton
Acier inoxydable et cotton
Rostfrei und Baumwolle

308 Escurridera / Conical colander /
Passoire conique / Konischer Seiher

INOX - ST/STEEL
EDELSTAHL
18/10



Extra fuerte /
Heavy duty /
Grande résistance /
Extra stark

REF	Ø cm	H cm	€	U
308.030	30	16,0	79,70	1
308.035	35	16,5	92,90	1
308.040	40	18,0	104,95	1
308.045	45	19,5	121,90	1
308.050	50	22,5	143,70	1

109 Escurridera con aro / Conical colander /
Passoire conique / Konischer Seiher mit Ring

ALUMINIO /
ALUMINIUM



REF	Ø cm	H cm	€	U
109.030	30	14,5	64,90	1
109.035	35	16,5	76,15	1
109.040	40	17,5	87,80	1
109.045	45	20,0	100,15	1
109.050	50	22,5	111,70	1

300 Escurridera inox con base / st/steel colander with stand /
Passoire inox sur pied / Seiher rostfrei mit Ständer

INOX - ST/STEEL
ROSTFREIER STAHL



REF	Ø cm	H cm	€	U
300.024	24	11,50	17,10	1
300.030	30	13,50	25,70	1

321 Colador / Colander /
Passoire / Seiher

INOX - ST/STEEL
EDELSTAHL
18/10



REF	Ø cm	€	U
321.020	20	40,70	1
321.022	22	45,95	1
321.024	24	53,15	1
321.026	26	60,00	1

945 Harinero / Flour bin /
Tamis à farine / Mehlsieb



REF	cm	€	U
945.037	37 x 26,5 x 18	120,30	1
945.050	50 x 26,5 x 18	125,20	1
945.051	50 x 33 x 18	135,90	1

313 Pasapurés / Vegetable sieve / Moulin à légumes / Passiermaschine



REF	Ø cm	€	U
313.025	25	42,70	1
313.030	30	65,55	1



Con filtro de recambio
With spare filter
Avec filtre recharge
Mit auswechselbarem Filter

3131 Pasapurés / Vegetable sieve / Moulin à légumes / Passiermaschine



REF	Ø cm	€	U
313.126	26	94,20	1
313.132	32	101,75	1



Con filtro de recambio
With spare filter
Avec filtre recharge
Mit auswechselbarem Filter

3132 Pasapurés plástico / Plastic vegetable sieve / Mouline à légumes en plastique / Passiermaschine Plastik

Con 3 discos inox. intercambiables /
With 3 St/Steel interchangeable cutters /
Avec 3 coupeurs inox interchangeables /
Mit 3 auswechselbaren Scheiben rostfrei



REF	Ø cm	€	U
313.200	23,5	25,60	1

3135 Pasapurés / Potato ricer / Presse-purés / Kartoffelpresse



REF	Ø cm	L cm	€	U
313.500	9	30,5	30,65	1

958 Gancho acero inoxidable 1p. / St/Steel hook 1p. / Crochet inox 1p. / Haken rostfrei 1 St.



REF	L mm	€ (10 un.)*	U
958.010	100 x 4	6,60	1
958.012	120 x 5	9,10	1
958.014	140 x 6	9,90	1
958.016	160 x 6	10,90	1
958.018	180 x 6	12,30	1

*Precio caja 10 unidades
*Price 10 units box
*Prix colis 10 unités
*Preis Kiste 10 Teile

9755 Mandolina corte "V" / "V" shaped mandoline slicer / "V" mandoline / Gemüsehobel "V"

PLÁSTICO / PLASTIC / PLASTIQUE / PLASTIK

REF	€	U
975.500	32,85	1

Incluye: 2 cuchillas + 3 guías plástico grosor (1 mm / 2 mm / 3 mm). Pies goma antideslizantes / Includes: 2 julienne blades + 3 thickness guides (1 mm / 2 mm / 3 mm) / Comprend: 2 lames julienne + 3 guides épaisseur (1 mm / 2 mm / 3 mm) / Inklusive: 2 Klingen + 3 Schneideplatten (1 mm / 2 mm / 3 mm)



9756 Mandolina / Mandoline / Mandoline / Mandoline

ACERO INOXIDABLE / ST/STEEL / ACIER INOXYDABLE / ROSTFREIER STAHL

REF	€	U
975.600	92,80	1

Incluye: cuchilla giratoria + regulador de espesor corte (3, 6 y 9 mm) / Includes: rotating blades + thickness regulator (3, 6 and 9 mm) / Comprend: lames tournantes + regulateur épaisseur (3, 6 et 9 mm) / Inklusiv: drehbare Klinge + Breitenregulierer (3, 6 und 9 mm)



9759 Cortador tomates / Tomatoes slicer / Coupe tomates / Tomatenschneider

Espesor corte 6,4 mm / Slice thickness 6,4 mm / Épaisseur de coupe 6,4 mm / Schnittbreite 6,4 mm

REF	cm	€	U
975.900	39 x 21,5 x 20	183,55	1
RE975.901	25 x 6,8	50,35	1



RE975.901 Cuchilla / Blade / Lame / Klingen

868 Dispensador a presión / Squeeze dispenser / Distributeur à pression / Einzeldosierer



REF	ml	COLOR / COLOUR / COULEUR / FARBE	€	U
868.001	240	Rojo / Red / Rouge / Rot	1,10	12
868.002	360	Rojo / Red / Rouge / Rot	1,25	12
868.003	720	Rojo / Red / Rouge / Rot	1,85	12
868.004	240	Amarillo / Yellow / Jaune / Gelb	1,10	12
868.005	360	Amarillo / Yellow / Jaune / Gelb	1,25	12
868.006	720	Amarillo / Yellow / Jaune / Gelb	1,85	12
868.007	240	Transparente / Clear / Transparent / Transparent	1,10	12
868.008	360	Transparente / Clear / Transparent / Transparent	1,25	12
868.009	720	Transparente / Clear / Transparent / Transparent	1,85	12

8681 Dispensador a presión doble / Twin squeeze dispenser / Distributeur à pression double / Zweifachdosierer



REF	ml	€	U
868.100	200	2,55	12

IDEA!

Ideal para decoración
Ideal for dish presentation
Idéal pour decoration
Ideal für die Dekoration

8682 Dispensador a presión triple / Tri squeeze dispenser / Distributeur à pression triple / Dreifachdosierer



REF	ml	€	U
868.200	500	5,85	12

IDEA!

Ideal para decoración
Ideal for dish presentation
Idéal pour decoration
Ideal für die Dekoration

954 Embudo con filtro extraíble / Funnel with removable filter / Entonnoir avec filtre extractible / Trichter mit herausnehmbarem Filter



REF	Ø cm	€	U
954.013	13	18,90	1
954.015	15	20,45	1
954.020	20	21,95	1
954.025	25	24,95	1

946 Especieros / dredgers / Saupoudreuses / Streuer



REF	Ø cm	H cm	Ø mm	€	U
A 946.001	7	9,6	-	7,60	12
B 946.002	7	9,6	2	6,15	12
C 946.003	7	9,6	3	6,25	12
D 946.004	7	9,6	4	6,25	12

Especiero "A" con malla
Dredger "A" with mesh
Saupoudreuse "A" maillée
Streuer "A" mit Maschen

Con tapón de plástico
With plastic cover
Avec couvercle en plastique
Mit Plastideckel

870 Molde huevo sandwich redondo /
Round egg ring /
Moule à oeuf rond /
Runde Sandwicheierform



REF	Ø cm	H cm	€	U
870.000	8,5	11,0	2,75	1

871 Molde huevo sandwich cuadrado /
Squared egg mould /
Moule à oeuf carré /
Rechteckige Spiegeleierform



REF	cm	H cm	€	U
871.000	8,5 x 8,5	11,0	2,75	1

905 Aplastacarnes inox forjado
Solid St/Steel meat beater
Aplatisseur inox forgé
Solider Fleischstampfer rostfrei



REF	Ø cm	Kg	L cm	€	U
905.015	10	1,5	14	46,80	1

942 / 943 Aplastadora carne
Meat beater
Aplatisseur à viande
Fleischstampfer



REF	Ø cm	Kg	L cm	€	U
942.000	9,5	0,750	28,5	26,75	1
943.000	9,5	0,750	28,5	26,75	1

334 Alcuza / Oil pourer /
Huilière / Ölkanne



REF	Lts	€	U
334.025	0,25	21,40	1
334.050	0,50	25,70	1
334.100	1,00	33,75	1
334.200	2,00	44,35	1

873 Barra de notas de aluminio /
Aluminium check minder /
Barre porte-bons en aluminium /
Aluminiumleiste für Notizen



REF	L cm	H cm	€	U
873.045	45	5,0	11,25	1
873.060	60	5,0	13,85	1
873.090	90	5,0	20,90	1

941 Sierra de cocina / kitchen bow saw / Scie de cuisine / Küchensäge



REF	cm	€	U
941.000	62 x 20	62,35	1
RE941.001	Hoja / Blade / Lame / Blatt	14,20	1

94009 Remo acero inoxidable / St/Steel mixing paddle / Spatule géante inoxydable / Rührpaddel rostfrei



REF	PALA / PEEL / PELLE / BLATT CM	L cm	€	U
940.090	12 x 19	90	38,85	1
940.120	16 x 19,5	120	47,55	1

323 Tenedor / fork / Fourchette / Spiess



REF	L cm	€	U
323.050	50	11,45	5

940 Rascador con mango aluminio / Grill scraper aluminium / Raclette à plancha / Schaber mit Aluminiumgriff



REF	cm	€	U
940.000	44,5 x 12 x 12,7	39,35	1
RE940.001	12,7 x 7,7	7,90	1

944 Escamador / Fish scaler / Ecailleur / Fischentschupper



REF	L cm	€	U
944.000	23,5	3,20	1

953 Cepillo multiusos / Utility brush / Brosse de nettoyage / Nützliche Bürste



REF	cm	€	U
953.000	23,5 x 7,5	5,65	1

UTENSILIOS DE COCINA / KITCHEN UTENSILS / USTENSILES DE CUISINE / KÜCHENUTENSILIEN

975 Cortador de patatas fritas / French fry cutter / Coupe frites / Pommesschneider

Con ventosas de agarre en la base
With suction base
Avec ventouse d'accrochement à la base
Mit Saugfüßen

Acero inox
Stainless steel
Acier inoxydable
Rostfreier Stahl

Con cortadores de 36 y 64 agujeros
With 36 & 64 holes cutter
Avec coupeur de 36 et 64 trous
Mit 36 & 64 Gittereinsatz



REF	AGUJEROS / HOLES / TROUS / LÖCHER	€	U
975.000	-	53,60	1
RE 975.001	36	7,25	1
RE 975.002	64	7,35	1

RE 975.001



□ 10 x 10 Cuchilla de recambio de 36 agujeros
Knife (spare part) 36 holes
Couteau (pièce de rechange) 36 trous
Messereinsatz 36 Löcher

RE 975.002



□ 8 x 8 Cuchilla de recambio de 64 agujeros
Knife (spare part) 64 holes
Couteau (pièce de rechange) 64 trous
Messereinsatz 64 Löcher

9751 Cortador de patatas fritas en acero y plástico / St/Steel and plastic french fry cutter / Coupe frites en acier inox et plastique / Pommesschneider aus Plastik und rostfrei



REF	AGUJEROS / HOLES / TROUS / LÖCHER	€	U
975.100	-	41,40	1
RE 975.101	36	7,15	1
RE 975.102	64	8,20	1

RE 975.101



□ 10 x 10 Cuchilla de recambio de 36 agujeros
Knife (spare part) 36 holes
Couteau (pièce de rechange) 36 trous
Messereinsatz 36 Löcher

RE 975.102



□ 8 x 8 Cuchilla de recambio de 64 agujeros
Knife (spare part) 64 holes
Couteau (pièce de rechange) 64 trous
Messereinsatz 64 Löcher

Cortahuevos guitarra de acero inox / St/Steel egg slicer /

390 Coupe-oeuf en acier inox / Eierschneider rostfrei



REF	cm	€	U
390.000	7,7 x 9,4	11,65	1

3901 Cortahuevos doble uso / 2 way egg cutter / Coupe-oeuf 2 utilisations / 2 Weg Eierschneider



REF	cm	€	U
390.100	11,5 x 9,5 x 3,5	12,20	1

Cortador y descorazonador manzanas / Apple cutter & corer /

610 Vide et coupe pommes / Apfelschneider und Enthazer



REF	Ø cm	€	U
610.000	8,5	6,65	1

Cuchilla en acero inoxidable y marco en aluminio de fundición
St/Steel blades with cast aluminium frame
Lames inox et manche en aluminium fonté
Messer aus rostfreiem Stahl und Rahmen aus Aluminiumguss

938 Prensa ajos / Garlic Press / Presse-ail / Knoblauchpresse



REF	€	U
938.000	7,70	1

Aluminio fundición
Cast aluminium
Fonté d'aluminium
Aluminiumguss

937

Máquina multi-usos / Versatil machine / Machine universel / Universelle Maschine

Cortador patatas
French fry cutter
Coupe frites
Kartoffelschneider



□ 12 x 12 mm



Cortador manzanas
Apple cutter & corer
Vide et coupe pommes
Apfelschneider



REF	H cm	€	U
937.000	80	135,30	1

REF	€	U
RE937.001	17,10	1
RE937.002	17,10	1
RE937.003	17,10	1

Recambio cortador patatas / French fry cutter spare part /
Coupe frites (pièce rechange) / Austauschbarer Pommesschneider

Recambio cortador manzanas / Apple cutter spare part /
Coupe pommes (pièce rechange) / Austauschbarer Apfelschneider

Recambio exprimidor zumos / Juicer spare part /
Press fruits (pièce rechange) / Austauschbarer Entsafter

Exprimidor zumos
Juicer
Presse-fruits
Entsafter



Abrelatas industrial acero inoxidable /
St/Steel can opener /
Ouvre-boîtes professionnel en acier inoxydable /
Industrieller Edelstahl Dosenöffner

964**9641**

Cuchilla de recambio / Knife (spare part) /
Couteau (pièce de rechange) / Austausch Klinge

9642

Rodillo de recambio / Wheel (spare part) /
Rouleau (pièce de rechange) / Austauschrad

Altura máxima de las latas: 55 cm
Maximum height of cans: 55 cm
Hauteur maximale des boîtes: 55 cm
Maxmale Höhe der Dosen : 55 cm



REF	H cm	€	U
964.000	60	134,80	1

REF	€	U
RE 964.100	10,20	1

REF	€	U
RE 964.200	23,70	1



ESPAÑOL

PRESENTAMOS UNA NUEVA GAMA DE TABLAS DE CORTE CON MÁS DE 20 MODELOS DISTINTOS Y MÁS DE 100 REFERENCIAS, CONCEBIDAS PARA SATISFACER TODAS LAS NECESIDADES DEL MERCADO. OFRECEMOS TAMBIÉN LA POSIBILIDAD DE FABRICAR MEDIDAS Y GROSORES ESPECIALES SOBRE PEDIDO. LA NUEVA GAMA DE TABLAS DE CORTE SE PRESENTA EN DOS MODALIDADES; UNAS FABRICADAS EN POLIETILENO (PE) POR INYECCIÓN Y LA GAMA MÁS EXTENSA EN POLIETILENO 500 ALTA DENSIDAD (HD PE 500) POR TERMOCOMPRESIÓN.

ENGLISH

WE INTRODUCE HERE WITH THE NEW RANGE OF CUTTING BOARD WITH MORE THAN 20 DIFFERENT PATTERNS AND MORE THAN 100 REFERENCES CONCEIVED TO FULFILL ALL THE MARKET NEEDS. WE ALSO OFFER THE POSSIBILITY TO PRODUCE SPECIAL SIZES AND THICKNESSES UPON REQUEST. THIS NEW RANGE OF CUTTING BOARDS IS PRESENTED IN TWO DIFFERENT MATERIALS, ONE MADE OF POLYETHYLENE (PE) USING THE INJECTION TECHNIQUE AND THE WIDEST RANGE ON HIGH DENSITY POLYETHYLENE 500 (HD PE 500) THROUGH THERMO COMPRESSION.

FRANÇAIS

NOUS PRÉSENTONS UNE NOUVELLE GAMME DE PLANCHES À DÉCOUPER AVEC PLUS DE 20 MODÈLES DIFFÉRENTS ET PLUS DE 100 RÉFÉRENCES, CONÇUES POUR SATISFAIRE TOUS LES BESOINS DU MARCHÉ. NOUS OFFRONS AUSSI LA POSSIBILITE DE FABRIQUER DES PLANQUES AVEC DES MESURES ET DES ÉPAISSEURS SPÉCIALES SUR COMMANDE. CETTE NOUVELLE GAMME DE PLANCHES À DÉCOUPER SE PRÉSENTENT EN DEUX MATERIAUX DIFFÉRENTS: CERTAINES SONT PRODUITES EN POLYÉTHYLÈNE (PE) PAR INJECTION ET LA MAJORITÉ DE LA GAMME EST PRODUITE EN POLYÉTHYLÈNE 500 DE HAUTE DENSITÉ (HD PE 500) PAR THERMO COMPRESSION.

DEUTSCH

WIR PRÄSENTIEREN EINE NEUE PRODUKTREIHE VON SCHNEIDEBRETTERN MIT MEHR ALS 20 VERSCHIEDENEN MODELLEN UND ÜBER 100 ARTIKEL, UM DIE BEDÜRFNISSE DES MARKTS ZUFRIEDEN ZU STELLEN. WIR BIETEN AUCH DIE MÖGLICHKEIT SPEZIELLE MASSE UND DICKE HERZUSTELLEN ABHÄNGIG VON DER BESTELLUNG. DIE NEUE PRODUKTREIHE BIETEN WIR IN ZWEI VERSCHIEDENEN VARIANTEN AN: EINE VARIANTE HERGESTELLT AUS POLYETHYLEN (PE) DURCH SPRITZVERFAHREN UND DIE BREITESTE PRODUKTVARIANTE HERGESTELLT AUS POLYETHYLEN 500 HOHE DICHT (HD PE 500) DURCH WÄRMEDRUCKVERFAHREN.



PESCADO CRUDO
RAW FISH
POISSON CRU
ROHER FISCH



PAN Y LACTEOS
BAKERY & DAIRY
PAIN ET PRODUITS LAITIERS
BROT UND
MILCHPRODUKTE



CARNE GUISADA
COOKED MEAT
VIANDE CUISINÉE
GEKOCHTES FLEISCH



FRUTA & VEGETALES
FRUIT & VEGETABLES
FRUIT ET LÉGUMES
OBST & GEMÜSE



CARNE CRUDA
RAW MEAT
VIANDE CRU
ROHES FLEISCH



CARNE CRUDA DE AVES
RAW PAULTRY & CHICKEN
VIANDE CRU ET VOLAILLES
ROHES GEFLÜGEL



> CARACTERÍSTICAS PRINCIPALES

Las tablas de corte fabricadas en Polietileno 500 alta densidad, se caracterizan por un alto peso molecular (HMWPE) ofreciendo:

- Alta DURABILIDAD
- 25% más resistencia a la ABRASIÓN.
- Mayor temperatura de fusión: 135,4 °C
- Temperatura de reblandecimiento 83 °C
- Mayor RIGIDEZ

* No presentan deformación durante el aclarado del ciclo de lavado en lavavajillas industriales (temp. máx. aprox. 80 °C)

Conforme a las normativas siguientes:

RD 1712/91 registro sanitario de alimentos
CE 1935/2004.

> MAIN FEATURES

The cutting boards made of High Density Polyethylene 500 have higher molecular weight (HMWPE), offering the following properties:

- High DURABILITY
- 25% more resistance to ABRASION
- Higher Fusion temperature: 135,4 °C
- Softening temperature: 83 °C
- Extraordinary RIGIDNESS

* Do not present deformation during the rinsing process of industrial dishwasher cleaning cycle (max. temp. aprox. 80 °C).

Following the CE 1935/2004 regulation.

> CARACTÉRISTIQUES PRINCIPALES

Les planches à découper fabriquées en Polyéthylène 500 haute densité ont un poids moléculaire (HMWPE) plus grand qui offre les suivantes propriétés:

- Longue DURÉE
- 25% plus résistant à l'ABRASION
- Température de fusion: 135,4 °C
- Température de ramolissement: 83 °C
- RIGIDITÉ maximale

* Ne présente pas de déformation lors du cycle lavage dans le lave-vaisselles industriel (Temp. max. aprox. 80 °C).

Conforme à la réglementation 1935/2004.

> Haupteigenschaften

Die Schneidbretter hergestellt aus Polyethylen 500 hohe Dichte haben ein höheres Molekulargewicht (HMWPE), mit folgenden Eigenschaften:

- Hohe Langlebigkeit
- 25% höherer Verschleisswiderstand
- Höhere Schmelztemperatur: 135,4 °C
- Erweichungstemperatur: 83 °C
- Extrahohe Starrheit

* Es treten keine Verformungen beim Spülvorgang in industriellen Spülmaschinen auf (max. Temp. ca. 80 °C).

Entsprechend der Norm CE 1935/2004.

TABLAS DE CORTE / CUTTING BOARDS / PLANCHES À DÉCOUPER / SCHNEIDBRETTER

9112



Con pies silicona
With silicon feet
Avec pieds en silicone
Mit Silikonfüssen

REF	Color	mm	H mm	€	U
911.201		400 x 300	20,0	23,20	1
911.202		600 x 400	20,0	41,30	1

9113 GN 1/1



Con ranura
With groove
Avec rigole
Mit Fuge

REF	Color	mm	H mm	€	U
911.301		530 x 325	20,0	31,80	1
911.302		530 x 325	20,0	31,80	1
911.303		530 x 325	20,0	31,80	1
911.304		530 x 325	20,0	31,80	1
911.305		530 x 325	20,0	31,80	1
911.306		530 x 325	20,0	31,80	1

9118

300 x 200 x 20



Con pies silicona
With silicon feet
Avec pieds en silicone
Mit Silikonfüssen

REF	Color	mm	H mm	€	U
911.801		300 x 200	20,0	11,95	1
911.802		300 x 200	20,0	12,60	1
911.803		300 x 200	20,0	12,60	1
911.804		300 x 200	20,0	12,60	1
911.805		300 x 200	20,0	12,60	1
911.806		300 x 200	20,0	12,60	1

9117 GN 1/2

320 x 265 x 20



Con pies silicona
With silicon feet
Avec pieds en silicone
Mit Silikonfüssen

REF	Color	mm	H mm	€	U
911.701		320 x 265	20,0	16,70	1

9120

400 x 200 x 20



Con pies silicona
With silicon feet
Avec pieds en silicone
Mit Silikonfüssen

REF	Color	mm	H mm	€	U
912.001		400 x 200	20,0	15,95	1

9114

400 x 300 x 20



Con pies silicona
With silicon feet
Avec pieds en silicone
Mit Silikonfüssen

REF	Color	mm	H mm	€	U
911.401		400 x 300	20,0	24,05	1
911.402		400 x 300	20,0	25,25	1
911.403		400 x 300	20,0	25,25	1
911.404		400 x 300	20,0	25,25	1
911.405		400 x 300	20,0	25,25	1
911.406		400 x 300	20,0	25,25	1

9119

500 x 300 x 20



Con pies silicona
With silicon feet
Avec pieds en silicone
Mit Silikonfüssen

REF	Color	mm	H mm	€	U
911.901	White	500 x 300	20,0	30,15	1
911.902	Red	500 x 300	20,0	31,60	1
911.903	Blue	500 x 300	20,0	31,60	1
911.904	Yellow	500 x 300	20,0	31,60	1
911.905	Green	500 x 300	20,0	31,60	1
911.906	Brown	500 x 300	20,0	31,60	1

9115 GN 1/1

530 x 325 x 20



Con pies silicona
With silicon feet
Avec pieds en silicone
Mit Silikonfüssen

REF	Color	mm	H mm	€	U
911.501	White	530 x 325	20,0	34,55	1
911.502	Red	530 x 325	20,0	36,30	1
911.503	Blue	530 x 325	20,0	36,30	1
911.504	Yellow	530 x 325	20,0	36,30	1
911.505	Green	530 x 325	20,0	36,30	1
911.506	Brown	530 x 325	20,0	36,30	1

9116

600 x 400 x 20



Con pies silicona
With silicon feet
Avec pieds en silicone
Mit Silikonfüssen

REF	Color	mm	H mm	€	U
911.601	White	600 x 400	20,0	48,15	1
911.602	Red	600 x 400	20,0	50,60	1
911.603	Blue	600 x 400	20,0	50,60	1
911.604	Yellow	600 x 400	20,0	50,60	1
911.605	Green	600 x 400	20,0	50,60	1
911.606	Brown	600 x 400	20,0	50,60	1

9135 Bar



Sin pies
Without feet
Sans pieds
Ohne Füße

REF	Color	mm	H mm	€	U
913.501	White	160 x 250	10,0	5,75	1
913.601	White	250 x 200	10,0	7,25	1
913.701	White	300 x 200	10,0	8,65	1
913.901	White	320 x 240	10,0	11,05	1

9130 Mesa de corte / Cutting board table / Table de découpe / Schneidstisch



Con ranura
With groove
Avec rigole
Mit Fuge

No incluye contenedor Gastronorm
Delivered without the GN container
Livré sans le bac GN
Ausschliesslich GN Behälter

REF	Color	mm	H mm	€	U
913.000	White	650 x 400	110,0	92,80	1

Para almacenar alimentos recién cortados en cubeta GN 1/3
Perfect for storing direct cut products into a 1/3 GN pan
Permet découper les produits directement au dessus du bac Gastronorme 1/3
Für die Aufbewahrung von frischgeschnittenen Lebensmitteln im Behälter GN 1/3

901 Recogeverduras inox / St/Steel vegetable picker / Pelle à légumes inox / Gemüsehacker rostfrei



REF	cm	€	U
901.014	14 x 10	9,00	1
901.018	18 x 12	9,85	1



604 Jarra de medidas /
Measuring jug /
Pot mesureur /
Messbecher



REF	Lts	€	U
604.001	1,00	16,70	1
604.002	2,00	32,00	1

846 Jarra de medidas en polipropileno /
Polypropylene measuring jug /
Pot mesureur en polypropylène /
Messbecher aus Polypropylen



REF	Lts	€	U
846.025	0,25	3,90	1
846.050	0,50	4,00	1
846.100	1,00	6,55	1
846.200	2,00	11,05	1
846.300	3,00	13,20	1

6045 Juego 4 cazos de medidas inox /
St/Steel 4 pcs set measuring cups /
Set 4 casseroles doseur /
4 teiliges Messkellenset rostfreies Stahl



REF	ml	€	U
604.500	59 - 78 - 118 - 236	8,60	12

603 Cubo con base /
Bucket with base /
Seau avec base /
Eimer mit Skalierung



REF	Ø cm	H cm	Lts	€	U
603.012	31	28,50	12,00	109,05	1
603.015	32,5	32,50	15,00	119,15	1

600 Balanza mecánica / Mechanical scale /
Balance automatique / Mechanische Waage



REF	kg	Grs	€	U
600.005	5	20	53,70	1

Cuerpo y bandeja de acero inox.
Bandeja superior plana con botón regulador.
Body and upper flat platform in St/Steel with regulation button.
Corps et plate-forme plane supérieure en inox.
Bouton de régulation.
Körper und Plattform aus rostfreiem Stahl.
Ebene obere Plattform mit regulierbarem Knopf.

601 Balanza mecánica / Mechanical scale /
Balance automatique / Mechanische Waage



REF	kg	Grs	€	U
601.010	10	50	60,40	1

Cuerpo y bandeja de acero inox.
Bandeja superior plana con botón regulador.
Body and upper flat platform in St/Steel with regulation button.
Corps et plate-forme plane supérieure en inox.
Bouton de régulation.
Körper und Plattform aus rostfreiem Stahl.
Ebene obere Plattform mit regulierbarem Knopf.

602 Balanza mecánica /
Mechanical scale /
Balance automatique /
Mechanische Waage



REF	kg	Grs	€	U
602.015	15	50	63,25	1

Cuerpo y bandeja de acero inox.
Bandeja superior bombeada con botón regulador.
Body and upper conical platform in St/Steel with regulation button.
Corps et plate-forme bombée supérieure en inox.
Bouton de régulation.
Körper und Plattform aus rostfreiem Stahl.
Halbkugelige obere Plattform mit regulierbarem Knopf.

6092 Balanza digital acero /
Electronic scale /
Balance électronique en inox /
Digitale Waage rostfrei



REF	kg	€	U
609.200	10	109,05	1

Plataforma y base en acero inox. Pantalla LED Superficie impermeable Panel digital	Plateau et base fabriqués en inox. Scran LED Surface impèrmeable
Surface and base made of St/Steel LED Display Waterproof surface Touch-panell switch	Körper und Plattform rostfrei LED Display Wasserdichte Oberfläche Touch-Screen Bedienung

20 gr - 5000 gr / 1 gr
5002 gr - 10000 gr / 2gr

609 Balanza digital / Electronic scale / Balance électronique / Digitale Waage

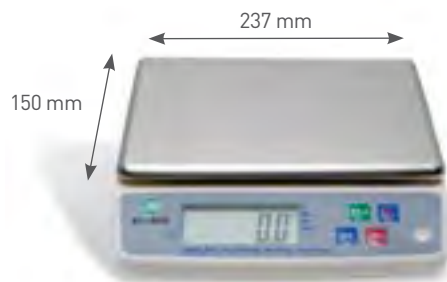

REF	Kg	Grs	€	U
609.010	10	2	120,70	1

Alta precisión y rendimiento / Multifunción de peso y contador.
High accuracy and performance / Multi-function weighing and counting both ability.
Haute précision et performance / Multi-fonction de poids et compteur.
Hohe Genauigkeit und Performenz/ Multi-Funktion Wiegen und Zählen.

6097 Balanza electrónica / Electronic kitchen scale / Balance électronique / Elektronische Waage



REF	Kg	Grs	Ø plat cm	€	U
609.705	5	1	11	18,90	1

Gran precisión / Multifunción de peso / Contador de piezas / Sistema ahorro energía / Bandeja de plástico.
High accuracy / Multi-function weight and counting / Energy-saving system / Plastic Platform.
Haut précision / Multi-fonction des poids / Compteur des pièces / Système d'économie d'énergie / Plateau en plastique.
Hohe Präzision / Multi-Funktion Wiegen / Stückzähler
Energiesparsystem / Plattform Plastik.

611 Reloj de cocina digital / Kitchen timer alarm / Minuteur de cuisine / Digitale Küchenuhr



REF	cm	€	U
611.000	6,8 x 6,8 x 2,5	5,70	1

Termómetro nevera. Acabado esmaltado /
Cold storage thermometer. Enameled finish /
Thermomètre congelateur. Émaillé /
Külschrankthermometer. Emailierte Ausfertigung

9800



REF	L cm	Temp.	€	U
980.000	28	-30 °C / +50 °C	10,00	1

9802 Termómetro de cocción con protección de plástico / Cooking thermometer with plastic protection / Thermomètre à cuisson avec gaine plastique / Kochthermometer mit Plastikschutz



REF	L cm	Temp. max.	€	U
980.200	28	100 °C	20,65	1

Termómetro nevera horizontal /
Horizontal refrigerator thermometer /
Thermomètre congelateur horizontal /
Horizontales Külschrankthermometer

98005



REF	mm	Temp.	€	U
980.050	135 x 35	-40 °C / +20 °C	9,00	6

9816 Termómetro de cocción con protección de plástico /
Cooking thermometer with plastic protection /
Thermomètre à cuisson avec gaine plastique /
Kochthermometer mit Plastikschutz



REF	L cm	Temp. max.	€	U
981.600	17	-10 °C / +200 °C	21,80	1

981650 Termómetro bolsillo con protección /
Pocket thermometer with protection /
Thermomètre de poche avec protection /
Taschenthermometer mit Schutz



REF	L cm	Temp. max.	€	U
981.650	14,3	-40 °C / +70 °C	6,25	1

9814 Termómetro digital / Digital thermometer /
Thermomètre digital / Digitales Thermometer



REF	mm	Display mm	Temp.	€	U
981.400	135 x 92 x 27	42 x 22	-20 °C / +200 °C	131,30	1

Con sonda de acero inoxidable.
Protección antisalpicaduras. Con pantalla iluminada.
La sonda esta sujeta al lateral del aparato.
With St/Steel probe. Splash-proof. Illuminated display.
Probe attached to side panel.
Avec sonde inox. Etanche aux éclaboussures.
Ecran illuminé. La sonde est attachée au côté lateral de l'appareil.
Temperaturfühler aus rostfreiem Stahl
Antispritzschutz. Beleuchtetes Display. Seitlicher Fühlerhalter.

9815 Termómetro digital de cocción con temporizador /
Cooking thermometer with timer /
Thermomètre à cuisson avec temporiseur /
Digitales Kochthermometer mit Timer-Funktion



REF	L mm sonda + cable	Temp.	€	U
981.500	90	0 °C / +200 °C	43,45	1

Plástico blanco. Base magnética para sujeción en superficies de metal.
Temperatura/tiempo programable con señal de alarma.
Sonda de acero inoxidable y cable alambre.
White plastic. Magnetic base for attachment on metal surface. Programmable temperature/time, with alarm signal. St/Steel probe and wire cable.
Plastique blanc. Base magnétique pour l'attacher à une surface métallique.
Température/temps programmable avec sonnette d'alarme. Sonde inox et filet.
Weisses Plastik. Magnetische Haftung für metallische Oberflächen.
Temperatur/Zeit programmierbar mit Alarm. Rostfreier Fühler mit Drahtkabel.

9804 Termómetro infrarojos con mira laser / Infrared thermometer with laser pointer /
Thermomètre infra-rouge a visée laser / Infrarot Thermometer mit Laser Pointer



REF	Temp.	L cm	€	U
980.400	-60 °C / +500 °C	17	143,70	1

Pantalla LCD
LCD Display
Écran LCD
LCD Display



Ideal para medir la temperatura de la superficie de los alimentos, sin contacto.
Non-contact temperature measure food's surface.
Ideal pour la mesure de température de surface des aliments, sans contact.
Ideal für Temperaturmessung von Lebensmittel ohne Berührung.

PROTECCIÓN TÉRMICA / HEAT PROTECTION / PROTECTION TÉRMIQUE / HITZESCHUTZ

947 Manopla horno ignífuga / Fireproof oven mitt / Gant à four ignifuge / Feuerfester Backhandschuh

REF	L cm	€	U
947.033	33	6,00	1
947.038	38	6,45	1
947.043	43	6,95	1

Algodón ignífugo Temp. Max. 220 °C
 Fireproof cotton
 Cotton ignifuge
 Feuerfeste Baumwolle

Ignífugo: Si la manopla toca directamente la llama, ésta no quemará hasta transcurridos 10 segundos, a partir de este tiempo la llama sí prenderá. Una vez fuera del contacto directo con la llama el fuego se extinguirá automáticamente.

Fire-proof: if the mitt touches fire by accident, it will not burn within 10 seconds, after then, it will be also on fire, but when you find it burns and get away from the flame, the fire on the mitt will go out automatically.

Ignifuge: si le gant est en contact direct avec la flamme, il ne brûlera pas pendant 10 secondes. Au delà de ces 10 secondes, il prendra feu. Une fois hors contact direct avec la flamme, le feu s'éteindra automatiquement.

Feuerfest: Wenn der Backhandschuh direkt mit der Flamme in Berührung kommt, wird er nicht innerhalb von 10 Sekunden brennen. Wenn er danach Feuer fängt wird die Flamme beim Entfernen automatisch erlöschen.

9471 Manoplas ignífugas con revestimiento silicona / Oven mitt flame retardant silicone coating / Moufles isolantes avec revêtement silicone / Feuerfester Backhandschuh mit Silikonbeschichtung

CE



REF	L cm	€	U
947.101	33	8,10	1
947.102	38	8,80	1
947.103	43	9,65	1

Se venden por pares Temp. Max. 220 °C
 Sold in pairs
 Vendues par paires
 Verkauf als Paar

Exterior fabricadas en 100% algodón + revestimiento silicona por una cara
 Outer made of 100% cotton + silicon coating on one side
 Extérieur fabriquées en 100% coton + revêtement en silicone par un coté
 Exterieur Herstellung aus 100% Baumwolle + einseitige Silikonbeschichtung

9472 Guantes anti-frío / Cold protection gloves / Gants anti-froid / Antikälte Handschuhe

CE



REF	Talla / Size / Taille / Grösse	€	U
947.201	S	10,75	1
947.202	M	11,05	1
947.203	L	12,80	1

Se venden por pares
 Sold in pairs
 Vendues par paires
 Verkauf im Paar

Fabricados de piel color gris conformes a las normas EN 388 y EN 407
 Made of leather compliant with the EN 388 and EN 407 standards
 Fabriqués en cuir et conformes aux norms EN 388 et EN 407
 Hergestellt aus grauem Leder entsprechend der Norm EN 388 und EN 407

9473 Guantes protección térmica / Heat protection gloves / Gants protection thermique / Hitzehandschuh

REF	Talla / Size / Taille / Grösse	€	U
947.301	S	33,15	1
947.302	M	34,10	1
947.303	L	34,95	1

Se venden por pares
 Sold in pairs
 Vendues par paires
 Verkauf im Paar

Fabricados con recubrimiento de nitrilo en el exterior y con forro interior de algodón y keviar jersey. Llevan un tratamiento Actifresh y Sanitized que los provee de protección contra los microorganismos los cuales pueden causar malos olores y riesgo de infecciones.

Outer nitril coated. Inner made of cotton and keviar jersey. They enjoy of Actifresh and Sanitized treatment to fight against micro organisms which can cause bad scents and risk of infections.

Fabriquéés avec un revêtement de nitrile à l'extérieur. Interieur de coton et keviar jersey avec un traitement Actifresh et Sanitized qui les fournit de protection contre les microorganismes lesquels peuvent causer de mauvais odeurs et risque d'infections.

Exterieur Herstellung aus Nitril. Innen aus Baumwolle und Kevlar Jersey. Sie werden mit Aktiv-Frisch- und Sanitierungverfahren behandelt, um gegen die Mikroorganismen entgegenzuwirken, die ursächlich sind für schlechte Gerüche und ein Risiko für Infektionen sein können.

9477 Manopla silicona con funda algodón / Silicone oven glove with cotton cover /
Gant silicone à fourreau coton / Silikonhandschuh mit Baumwollfutter



REF	L cm	€	U
947.700	42,5	28,10	1

9474 Manopla Silicona / Silicone oven mitt / Moufle en silicone / Silikonbackhandschuh



REF	L cm	€	U
947.400	30	17,00	1

9475 Manopla silicona / Silicone mitten / Mouflette en silicone / Silikonbackhandschuh



REF	cm	€	U
947.500	10,5 x 9	5,45	1

9476 Paño de silicona / Silicone pot-grabber / Torchon en silicone / Silikontuch

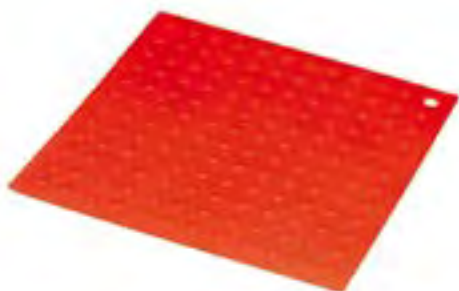

REF	cm	€	U
947.600	17,6 x 17,6	5,65	1



BATERÍA COCINA FOODIES /
FOODIES COOKWARE /
BATTERIE CUISINE FOODIES /
FOODIES KOCHBEDARF

2.1	PUJADAS 1921	92
2.2	BLACK SERIES	94
2.3	MULTIMETAL	98
2.4	COOL • LINE	100
2.5	IDEA	102
2.6	HOBBY CHEF	104
2.7	APARTAMENTO	106
2.8	UTENSILIOS DE COCINA / KITCHEN UTENSILS / USTENSILES DE CUISINE / KÜCHENUTENSILIEN	107

FOODIES

TÉRMINO INGLÉS QUE IDENTIFICA A LOS AMATEUR, AMANTES DE LA BUENA MESA, A LOS QUE LES ENCANTA LA COMIDA, SU ESTUDIO, SU PREPARACIÓN Y TODAS LAS NOTICIAS RELACIONADAS CON EL MUNDO DE LA GASTRONOMÍA. QUIEREN APRENDER TODO LO POSIBLE ACERCA DE LA COMIDA, TANTO LO MEJOR COMO LO COMÚN, Y DE LA CIENCIA, INDUSTRIA Y PERSONAJES QUE RODEAN AL MUNDO GASTRONÓMICO Y EN PUJADAS SE LO PONEMOS FÁCIL CON ESTE NUEVO CAPÍTULO /

ENGLISH TERM USED TO DESCRIBE AMATEURS, LOVERS OF GOOD FOOD, ITS STUDY, ITS PREPARATION AND ALL THE NEWS RELATED TO THE WORLD OF GASTRONOMY. PEOPLE WHO WANT TO LEARN EVERYTHING ABOUT FOOD, BOTH THE BEST AS WELL AS THE MORE EVERY DAY, THE SCIENCE, INDUSTRY AND THE FIGURES INVOLVED IN THE GASTRONOMIC WORLD. PUJADAS MAKE IT EASIER WITH THIS NEW SECTION /

TERME ANGLAIS DÉSIGNANT LES AMATEURS ET PASSIONNÉS DE LA BONNE TABLE, LES ADEPTES DE LA BONNE CUISINE, CEUX QUI RAFFOLENT DE SON ÉTUDE, SA PRÉPARATION ET TOUTES LES NOUVELLES CONCERNANT LE MONDE DE LA GASTRONOMIE. CEUX QUI SOUHAITENT AUSSI CONNAÎTRE TOUT LES SECRETS CULINAIRES, DES PLUS SOPHISTIQUÉS AUX PLUS COMMUNS, AINSI QUE DE LA SCIENCE, DE L'INDUSTRIE ET DES PERSONNALITÉS QUI GRAVITENT DANS L'UNIVERS GASTRONOMIQUE. PUJADAS VOUS FACILITE LA TÂCHE AVEC CETTE NOUVELLE SECTION /

ENGLISCHER BEGRIFF UM AMATEURE ZU BESCHREIBEN, LIEBHABER VON GUTEM ESSEN, WELCHE SEINEM STUDIUM, SEINER VORBEREITUNG UND ALLER MIT DER WELT DER GASTRONOMIE VEBUNDENEN NACHRICHTEN GENIESSEN. LEUTE, DIE ALLES MÖGLICHE ÜBER DAS ESSEN LERNEN WOLLEN, SOWOHL DAS BESTE ALS AUCH DAS GEWÖHNLICHE, DIE WISSENSCHAFT, DIE INDUSTRIE UND PERSONEN, DIE SICH IN DER WELT DER GASTRONOMIE BEWEGEN. PUJADES MACHT ES IHNEN EINFACH MIT DIESEM NEUEN KAPITEL EINFACH.



GUIA DE SELECCIÓN DE BATERÍA COCINA FOODIES / FOODIES COOKWARE SELECTION GUIDE / GUIDE DE SÉLECTION DE BATTERIE FOODIES / FOODIES KOCHBEDARF AUSWAHLÜBERSICHT

FOODIES

	PUJADAS 1921	BLACK SERIES	MULTIMETAL	COOL • LINE	IDEA	HOBBY CHEF	APARTAMENTO
REF / ITEM / CODE / ART.NR.			 NSF				
INDUCCIÓN / INDUCTION / INDUCTION / INDUKTION	✓✓✓	✓	✓✓	✓✓	✓✓	✓✓	✓✓
PRECIO / PRICE / PRIX / PREIS	€€	€€	€€€€€	€€€	€€€	€€€	€
GARANTÍA AÑOS / WARRANTY YEARS / GARANTIE ANNÉE / GARANTIE JAHRE	2	2	5	4	4	4	2
UTILIZACIÓN / USE / UTILISATION / GEBRAUCH	RÁPIDA Y POCO ACEITE / QUICK AND LITTLE OIL / RAPIDE ET PEU D'HUILE / SCHNELL UND WENIG ÖL	COCCIÓN LENTA / SLOW COOKING / CUISSON LENTE / LANGSAMES KOCHEN	ALTA COCINA / HIGH CUISINE / HAUTE CUISINE / HOHE KÜCHE	TODO USO / ALL-PURPOSES / TOUT TYPE DE CUISSON / GEEIGNET FÜR ALLE KÜCHENTYPEN	 ALL OVER TECH	TODO USO / ALL-PURPOSES / TOUT TYPE DE CUISSON / GEEIGNET FÜR ALLE KÜCHENTYPEN	USO DOMÉSTICO / HOME USE / USAGE DOMESTIQUE / HEIMGEBRAUCH
ANTIADHERENTE / NON-STICK COATING / ANTI-ADHÉSIF / ANTIHAFTBE-SCHICHTUNG	CERÁMICO RESISTENTE A ALTAS TEMPERATURAS / CERAMIC COATING RESISTANT TO HIGH TEMPERATURES / REVÊTEMENT CÉRAMIQUE RÉSISTANT À HAUTES TEMPERATURES / KERAMIKBESCHICHTUNG RESISTENT GEGEN HOHE TEMPERATUREN		SARTENES Y WOKS / FRY PANS & WOKS / POÊLES ET WOKS / BRATPFANNEN & WOK		SARTENES / FRY PANS / POÊLES / BRATPFANNEN 	SARTENES / FRY PANS / POÊLES / BRATPFANNEN 	SARTENES / FRY PANS / POÊLES / BRATPFANNEN
TAPA / LID / COUVERCLE / DECKEL	CRISTAL INCLUIDA / GLASS LID INCLUDED / COUVERCLE EN VERRE INCLUS / INKL. GLASDECKEL	CRISTAL INCLUIDA / GLASS LID INCLUDED / COUVERCLE EN VERRE INCLUS / INKL. GLASDECKEL	INOX OPCIONAL / ST/STEEL LID OPTIONAL / COUVERCLE INOX EN OPTION / EDELSTAHLDECKEL OPTIONAL	TAPA INOX INCLUIDA / ST/STEEL LID INCLUDED / COUVERCLE INOX INCLUS / EDELSTA HLDECKEL INKL	TAPA INOX INCLUIDA / ST/STEEL LID INCLUDED / COUVERCLE INOX INCLUS / EDELSTA HLDECKEL INKL	TAPA INOX INCLUIDA / ST/STEEL LID INCLUDED / COUVERCLE INOX INCLUS / EDELSTA HLDECKEL INKL	TAPA INOX INCLUIDA / ST/STEEL LID INCLUDED / COUVERCLE INOX INCLUS / EDELSTA HLDECKEL INKL
MANGO / HANDLE / QUEUE / STIL	INOX RESISTENTE AL CALOR / ST/STEEL HEAT RESISTANT / INOX RÉSISTANT À LA CHALEUR / EDELSTAHL HITZBESTÄNDIG	INOXIDABLE / ST/STEEL / INOXYDABLE / EDELSTAHL	INOXIDABLE / ST/STEEL / INOXYDABLE / EDELSTAHL	INOXIDABLE / ST/STEEL / INOXYDABLE / EDELSTAHL	INOXIDABLE / ST/STEEL / INOXYDABLE / EDELSTAHL	VARILLA INOX / INOX ST/STEEL WIRE / FIL INOX / EDELSTAHLDRAHT	BAQUELITA / BAKELITE / BAKÉLITE / BAKELIT
ASAS / HANDLES / ANSES / GRIFFE		MONOBLOC / ONE PIECE / MONOBLOC / MONOBLOCK		FUNDICIÓN / CAST / FONTE / GUSSEISEN			

BATERÍA COCINA FOODIES / FOODIES COOKWARE / BATTERIE CUISINE FOODIES

PUJADAS 1921

PARA UNA COCINA RÁPIDA Y SANA, PERMITE COCINAR CARNES, PESCADOS Y VERDURAS A FUEGO ALTO, USANDO MUY POCO ACEITE /

FOR A QUICK AND HEALTHY COOKING, IT ENABLES YOU TO COOK MEATS, FISH, VEGETABLES USING HIGH HEAT AND VERY LITTLE OIL /

POUR UNE CUISINE RAPIDE ET SAINTE, PERMETTANT DE CUISINER LES VIANDES, POISSONS ET LÉGUMES À FEU VIF, EN UTILISANT TRÈS PEU D'HUILE /

FÜR EINE SCHNELLE UND GESUNDE KÜCHE, ERLAUBT FLEISCH, FISCH UND GEMÜSE AUF HOHER FLAMME MIT WENIG ÖL ZU BRATEN.

VERDURAS CRUJIENTES Y CARNES TIERNAS, EN CUALQUIER TIPO DE COCINAS, ESPECIALMENTE INDUCCIÓN /

CRUNCHY VEGETABLES, TENDER MEATS, SUITABLE FOR ALL TYPES OF CUISINES, ESPECIALLY INDUCTION /

LÉGUMES CROQUANTS, VIANDES TENDRES, TOUT TYPE DE CUISINIÈRES, NOTAMMENT L'INDUCTION /

KNUSPRIGES GEMÜSE UND ZARTES FLEISCH, IN ALLEN KÜCHENTYPEN, SPEZIELL INDUKTION.



BATERÍA DE ACERO DE FUNDICIÓN LIGERO DE FÁCIL MANEJO /
LIGHT CAST STEEL COOKWARE EASY TO USE /
BATTERIE EN FONTE D'ACIER LÉGER, FACILE À MANIPULER /
GESCHIRR AUS LEICHTEM GUSSEISEN FÜR EINE EINFACHE HANDHABUNG

40% MENOS DE PESO QUE LAS SARTENES DE HIERRO TRADICIONAL /
40% LESS WEIGHT THAN TRADITIONAL IRON PANS /
40% DE POIDS EN MOINS PAR RAPPORT AUX POÊLES
EN FER TRADITIONNELLES /
40% WENIGER GEWICHT ALS DIE TRADITIONELLEN EISENBRATPFANNEN

TAPA DE CRISTAL INCLUIDA /
GLASS LID INCLUDED /
COUVERCLE EN VERRE INCLUS /
GLASDECKEL INKLUSIVE



MANGO ERGONÓMICO, RESISTENTE AL CALOR /
HEATPROOF ERGONOMIC HANDLE /
MANCHE ERGONOMIQUE, RÉSISTANT À LA CHALEUR /
HITZBESTÄNDIGER ERGONOMISCHER GRIFF

EXTRAORDINARIAS PROPIEDADES CALÓRICAS.
EXCELENTE Y HOMOGÉNEA DISTRIBUCIÓN DEL CALOR /

EXTRAORDINARY CALORIC PROPERTIES. EXCELLENT
AND UNIFORM HEAT DISTRIBUTION /

PROPRIÉTÉS CALORIQUES EXTRAORDINAIRES.
EXCELLENT ET HOMOGÈNE DISTRIBUTION DE LA CHALEUR /

AUSSERGEWÖHNLICHE KALORISCHE EIGENSCHAFTEN
EXZELLENT UND GLEICHMÄSSIGE HITZEVERTEILUNG

TRES CAPAS DE ANTIADHERENTE DE ÚLTIMA GENERACIÓN, LIBRE DE PFOA /
LAST GENERATION THREE LAYERS NON-STICK COATING. PFOA FREE /
TROIS COUCHE ANTI-ADHÉSIVE DE DERNIÈRE GÉNÉRATION. LIVRE DE PFOA /
DREIFACHE ANTIHAFTBESCHICHTUNG DER NEUESTEN GENERATIONEN. PFOA FREI

169 Sartén / Fry pan / Poêle / Bratpfanne



REF	Ø cm	H cm	€	U
169.020	20	4,5	25,40	1
169.024	24	4,5	27,50	1
169.028	28	5,5	32,20	1
169.030	30	5,5	34,45	1

165 Paellera sin tapa / Paella pan without lid / Plat à paella sans couvercle / Paellapfanne ohne Deckel



REF	Ø cm	H cm	Lts	€	U
165.024	24	3,0	1,20	25,50	1
165.030	30	3,0	1,90	32,00	1
165.034	34	3,0	2,30	36,50	1

166 Wok con tapa / Wok with lid / Wok avec couvercle / Wok mit Deckel



REF	Ø cm	H cm	Lts	€	U
166.032	32	8,0	4,40	49,30	1

167 Cazuela alta con tapa / Deep casserole with lid / Braisière avec couvercle / Hohe Kasserolle mit Deckel



REF	Ø cm	H cm	Lts	€	U
167.026	26	10,0	3,40	34,00	1
167.028	28	11,0	3,75	36,00	1
167.030	30	12,0	4,20	38,80	1
167.032	32	13,0	6,00	42,05	1

168 Cazuela baja con tapa / Shallow casserole with lid / Faitout avec couvercle / Flache Kasserolle mit Deckel



REF	Ø cm	H cm	Lts	€	U
168.024	24	6,0	2,00	32,85	1
168.028	28	7,0	3,00	38,45	1
168.030	30	8,0	3,80	41,50	1



ALUMINIO DE FUNDICIÓN. FONDO INDESTRUCTIBLE / CAST ALUMINIUM. INDESTRUCTIBLE BASE / FONTE D'ALUMINIUM. FOND INDESTRUCTIBLE / ALUMINIUMGUSS. UNTERBODEN UNZERSTÖRBAR



1491 Sartén mango inox / Fry pan st/steel handle / Poêle manche inox / Bratpfanne Edelstahlgriff



REF	Ø cm	H cm	€	U
149.120	20	5,0	28,75	4
149.124	24	5,0	32,10	4
149.128	28	5,0	39,65	4
149.130	30	5,0	42,60	4

1492 Sartén honda mango inox / Deep fry pan st/steel handle / Poêle haute manche inox / Hohe Bratpfanne Edelstahlgriff



REF	Ø cm	H cm	€	U
149.228	28	7,5	51,20	4

1493 Wok mango inox / Wok st/steel handle / Wok manche inox / Wok Edelstahlgriff



REF	Ø cm	H cm	€	U
149.330	30	9,5	46,50	4

1501 Sartén crêpes mango inox / Crêpe fry pan st/steel handle / Poêle à crêpes manche inox / Crêpepfanne Edelstahlgriff



REF	Ø cm	H cm	€	U
150.128	28	1,5	43,75	4

1421 Asador grill mango inox / Grill st/steel handle / Grill manche inox / Grillpfanne Edelstahlgriff



REF	Ø cm	H cm	€	U
142.100	28 x 28	4,0	53,60	4

BLACK SERIES

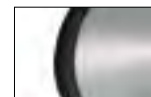

Fondo torneado
Ground base
Fond dressé
Gedrehter Unterboden

ESPAÑOL

GAMA DE ALUMINIO DE FUNDICIÓN TOTALMENTE INDEFORMABLE.

ENGLISH

RANGE OF CAST ALUMINIUM INDEFORMABLE.

FRANCAIS

GAMME EN FONTE D'ALUMINIUM INDÉFORMABLE.

DEUTSCH

PRODUKTSERIE AUS ALUMINIUMGUSS ABSOLUT UNVERFORMBAR.

155 Rustidera ovalada con tapa vidrio / Oval dish with glass lid / Cocotte avec couvercle / Co-cotte mit Deckel



REF	cm	H cm	€	U
155.032	32 x 23	10,5	77,00	1

Tapa Pyrex transformable en bandeja de servicio.
Pyrex cover that converts into serving tray.
Couvercle Pyrex transformable en plateau de service.
Pyrex-Deckel, auch als Schale verwendbar.

141 Cazuela baja sin tapa / Shallow casserole without lid / Cocotte sans couvercle / Flache Kasserolle ohne Deckel



REF	Ø cm	H cm	€	U
141.020 *	20	5,5	27,50	1
141.024	24	5,8	30,75	1
141.028	28	7,5	39,75	1
141.032	32	8,0	47,55	1
141.036	36	8,5	60,70	1
141.040	40	10,0	67,35	1

*MINI-SIZE

IDEA!

Ideal para presentación. Ver en pàg. 332
Ideal for food presentation. See page 332
Idéal pour présentation. Voir page 332
Ideal für die Präsentation. Siehe seite 332

151 Cazuela alta sin tapa / Deep casserole without lid / Braisière sans couvercle / Hohe Kasserolle ohne Deckel



REF	Ø cm	H cm	€	U
151.016 *	16	8,0	28,00	1
151.020	20	9,0	33,25	1
151.024	24	10,0	40,30	1
151.028	28	12,0	47,20	1
151.032	32	14,0	61,25	1

*MINI-SIZE

IDEA!

Ideal para presentación. Ver en pàg. 332
Ideal for food presentation. See page 332
Idéal pour présentation. Voir page 332
Ideal für die Präsentation. Siehe seite 332

152 Rustidera / Roast pan / Plaque à rôtir / Bräter



REF	cm	H cm	€	U
152.025 *	25 x 20	6,5	35,25	1
152.030	30 x 22	7,0	43,65	1
152.035	35 x 25	7,5	55,40	1

IDEA!

***MINI-SIZE**

Ideal para presentación
 Ideal for food presentation
 Idéal pour présentation
 Ideal für die Präsentation



153 Parrilla plana con asas / Hot-plate with handles / Grill plat avec poignées / Flache Bratplatte mit Griffen



REF. 153.025



REF. 153.050



REF. 153.034

REF	cm	H cm	€	U
153.025	25 x 25	2,0	40,00	1
153.034	34 x 26	2,5	57,55	1
153.050	50 x 30	2,5	96,90	1



150 Sartén crêpes mango baquelita / Crêpe fry pan bakelite handle / Poêle à crêpes manche bakélite / Crêpepfanne mit Bakelitstiel



REF	Ø cm	H cm	€	U
150.028	28	2,0	24,55	12



142 Asador grill mango madera / Grill wooden handle / Grill queue en bois / Grillpfanne mit Holzstiel



REF	cm	H cm	€	U
142.000	29 x 29	4,3	35,25	5



MULTIMETAL / MULTI-PLY / MULTI-METAL / MULTIMETALL

MULTIMETAL

APORTA TODAS LAS VENTAJAS DEL ALUMINIO Y DEL ACERO INOXIDABLE EN UNA SOLA PIEZA /
IT GETS ALL ADVANTAGES OF THE ALUMINIUM AND THE ST/STEEL JUST IN ONE /
APPORTE TOUS LES AVANTAGES DE L'ALUMINIUM ET DE L'ACIER INOXYDABLE EN UNE SEULE PIÈCE /
BIETET ALLE VORTEILE VON ALUMINIUM UND EDELSTAHL IN EINEM EINZIGEN STÜCK



INDUCTION



MANGOS TOTALMENTE ABIERTOS Y AISLANTES DEL CALOR /
HEAT INSULATED OPEN LONG HANDLES /
QUEUES TOTALEMENT OUVERTES ET ISOLANTES /
STIELE TOTAL OFFEN UND HITZEISOLIERT



TRANSMISIÓN TÉRMICA

El MULTIMETAL (5 capas) asegura una perfecta y homogénea distribución de la temperatura por toda la pieza.
Muy apta para PREPARADOS de cocción delicada: Elaboración de salsas, cremas, chocolate, etc.
Extremadamente eficiente (20% menos tiempo y energía).
Máximo rendimiento en todo tipo de cocinas ya sean GAS, VITROCERÁMICAS, ELÉCTRICAS o INDUCCIÓN.

HEAT TRANSMISSION

The homogenous heat transmission on the entire body makes the MULTIMETAL cookware 5 PLY highly recommended for the elaboration of sauces, chocolate, creams, etc.
Extremely efficient (20% less time and energy).
Highest performance on all kind of stoves, Either GAS, VITROCERAMIC, ELECTRIC and above all INDUCTION.

REPARTITION DE LA CHALEUR

LE MULTI-METAL (5-COUCHES) Assure une parfaite et homogène repartition de la chaleur dans tout le récipient.
Idéal pour les cuissons délicates, élaboration de sauces, crèmes, chocolats, etc. Très efficient (20% moins de temps et D'énergie).
Haute performance sur tout type de cuisinières: GAZ, VITROCÉRAMIQUE, ÉLECTRIQUE et surtout INDUCTION.

HITZ-VERTEILUNG

Das Multimetall (5 Schichten) gewährleistet eine perfekte und homogene Hitzeverteilung im ganzen Körper. Sehr geeignet für die Zubereitung von delikaten Speisen: Sossen, Cremes, Schokolade etc.
Aussergewöhnliche Effizienz (20% weniger Zeit und Energie). Höchste Leistung in allen Küchentypen GAS, KOCHFELDER, ELEKTRISCH ODER INDUKTION.



INOX - ST/STEEL ROSTFREIER STAHL



MULTIMETAL

238 Rustidera / Roast pan / Plaque à rôtir / Bräter



REF	cm	H cm	Lts	€	U
238.120	35,3 x 25	6,0	3,25	74,40	1

GN 1/2

233/ 2331 Sautex / Sauté pan / Sauteuse / Sauteuse



REF	Ø cm	H cm	Lts	€	U
233.024	24	6,0	2,50	60,60	1
233.028	28	6,0	3,50	64,80	1
233.032	32	6,0	4,50	77,40	1
233.124*	24	6,0	2,50	68,80	1
233.128*	28	6,0	3,50	77,60	1
233.132*	32	6,0	4,50	95,35	1

*ANTIADHERENTE / NON-STICK COATING / ANTI-ADHÉSIF / ANTIHAFTBESCHICHTUNG



234 Cazo bombeado / Rounded saucepan / Casserole bombée / Kugelige Stielkasserolle mit Schüttrand



REF	Ø cm	H cm	Lts	€	U
234.016	16	6,5	1,20	35,05	1
234.018	18	7,0	1,70	39,55	1
234.020	20	7,5	1,80	44,15	1
234.024	24	8,5	3,00	53,70	1
234.028	28	10,0	5,50	68,70	1

251 Sartén antiadherente excalibur / Non-stick frypan excalibur / Poêle anti-adhésive excalibur / Excalibur Antihaft Bratpfanne



REF	Ø cm	H cm	€	U
251.020	20	4,0	55,10	1
251.024	24	4,5	62,00	1
251.028	28	5,0	77,75	1
251.032	32	5,5	93,90	1

ANTIADHERENTE / NON-STICK COATING / ANTI-ADHÉSIF / ANTIHAFTBESCHICHTUNG



2390/ 2394 Wok fondo redondo / Round base wok / Wok à fond rond / Wok runder Boden



REF. 239.036



REF. 239.436*

REF	Ø cm	H cm	Lts	€	U
239.036	36	10,0	6,00	89,25	1
239.436*	36	10,0	6,00	112,50	1

*ANTIADHERENTE / NON-STICK COATING / ANTI-ADHÉSIF / ANTIHAFTBESCHICHTUNG



2391/ 2395 Wok fondo plano / Flat base wok / Wok à fond plain / Wok ebener Boden



REF. 239.136



REF. 239.536*

REF	Ø cm	H cm	Lts	€	U
239.136	36	9,0	5,50	89,25	1
239.536*	36	9,0	5,50	112,50	1

*ANTIADHERENTE / NON-STICK COATING / ANTI-ADHÉSIF / ANTIHAFTBESCHICHTUNG



COOL • LINE

COOL • LINE



CUERPO EN ACERO INOXIDABLE 18/10 /
COOKWARE BODY MADE OF 18/10 STAINLESS STEEL /
CORPS EN ACIER INOXYDABLE 18/10 /
KOCHEBEDARF AUS EDELSTAHL 18/10

ASAS ERGONÓMICAS FABRICADAS EN ACERO INOXIDABLE DE FUNDICIÓN /
HERGONOMIC HANDLES MADE OF CAST ST/STEEL
ANSES EN FONTE D'ACIER INOXYDABLE, ERGONOMIQUES /
GRIFFE AUS GUSSEDELSTAHL HERGESTELLT. ABSOLUT ERGONOMISCH



PULIDO BRILLANTE /
MIRROR POLISHING /
POLISSAGE BRILLANT /
GLÄNZEND POLIERT

TAPA CON DISEÑO ESPECIAL PARA APOYO EN ASA LATERAL /
SPECIAL LID DESIGNED TO HOLD ON THE SIDE HANDLE /
COUVERCLE SPÉCIAL, CONÇU POUR REPOSER SUR LA POIGNÉE /
SPEZIELLES DECKELDESIGN ZUM HALTEN IM SEITENGRIF



FONDO TERMO DIFUSOR ENCAPSULADO /
ENCAPSULATED SANDWICH BASE /
FOND THERMO-DIFFUSEUR ENCAPSULÉ /
KAPSELFÖRMIGER THERMODIFFUSIONSUNTERBODEN



4908 Olla con tapa / Stock pot with lid / Marmite traiteur avec couvercle / Kochtopf mit Deckel



REF	Ø cm	H cm	Lts	€	U
490.824	24	20,0	8,70	89,00	1
490.828	28	28,0	13,60	99,50	1

4906 Cacerola alta con tapa / Sauce pot with lid / Braisière avec couvercle / Hohe Kasserolle mit Deckel



REF	Ø cm	H cm	Lts	€	U
490.616	16	11,0	2,00	53,80	1
490.620	20	13,0	3,70	59,40	1
490.624	24	14,0	5,80	65,90	1
490.628	28	16,0	9,50	80,70	1
490.632	32	19,0	14,00	87,90	1

4907 Cacerola baja con tapa / Casserole with lid / Faitout avec couvercle / Flache Kasserolle mit Deckel



REF	Ø cm	H cm	Lts	€	U
490.716	16	7,5	1,50	51,90	1
490.720	20	8,0	2,50	57,20	1
490.724	24	9,5	3,90	65,20	1
490.728	28	11,0	5,80	75,40	1
490.732	32	12,5	8,90	83,60	1

4900 Cazo recto / Saucepan / Casserole / Gerade Stielkasserolle



REF	Ø cm	H cm	Lts	€	U
490.012	12	7,0	0,70	20,80	1
490.014	14	7,0	1,00	21,00	1
490.016	16	7,5	1,40	22,20	1
490.018	18	9,0	2,10	25,10	1
490.020	20	10,0	3,00	27,80	1

2371 Parte superior vaporera / Top for steam pot / Dessus cuit-vapeur / Oberteil Dampfgerer



REF	Ø cm	H cm	Lts	€	U
237.120	20	13,0	4,00	33,55	1
237.124	24	14,0	6,30	41,00	1

4902 Conjunto vaporera / Steam pot set / Cuit-vapeur / Dampfgererset



REF	Ø cm	H cm	Lts	€	U
490.220	A20	13,0	4,00	92,95	1
	B20	13,0	4,00		
490.224	A24	14,0	6,30	106,90	1
	B24	14,0	6,30		

IDEA COOKWARE

MUCHAS VECES LO MÁS IMPORTANTE ES LA IDEA /
SO OFTEN, THE MOST IMPORTANT POINT IS THE IDEA /
TRÈS SOUVENT, LE PLUS IMPORTANT C'EST L'IDÉE /
OFTMALS IST DIE IDEE DAS WICHTIGSTE



INDUCTION



ESPAÑOL

BATERÍA ELEGANTE Y DE ATRACTIVO DISEÑO EN ACERO INOXIDABLE, CON FONDO DIFUSOR COMPACTO, APTO PARA INDUCCIÓN. FABRICADO A TRAVÉS DE UNA SOFISTICADA TECNOLOGÍA, ALL-OVER TECHNOLOGY, QUE PERMITE RELLENAR TODO EL INTERIOR DEL FONDO CON UNA ESPESA CAPA DE ALUMINIO, SIN DEJAR CAVIDADES VACÍAS Y PERMITIENDO UNA DIFUSIÓN DEL CALOR, MÁS RÁPIDA Y UNIFORME HASTA LOS BORDES DEL RECIPIENTE /

ENGLISH

ELEGANT AND ATTRACTIVELY DESIGNED COOKWARE IN STAINLESS STEEL, WITH COMPACT SANDWICH-BOTTOM, SUITABLE FOR INDUCTION. MANUFACTURED USING SOPHISTICATED ALL-OVER TECHNOLOGY, WHICH ENABLES THE ENTIRE INSIDE OF THE BASE TO BE FILLED WITH A THICK LAYER OF ALUMINIUM, WITHOUT LEAVING EMPTY CAVITIES. THIS MEANS HEAT DIFFUSION IS FASTER AND EVEN TO THE EDGES OF THE RECIPIENT /

FRANÇAIS

BATTERIE ÉLÉGANTE AU DESIGN ATTRACTIF EN ACIER INOXYDABLE, AVEC FOND DIFFUSEUR COMPACT, ADAPTÉE À L'INDUCTION. FABRIQUÉE GRÂCE À UNE TECHNOLOGIE SOPHISTIQUÉE - ALL-OVER TECHNOLOGY - PERMETTANT DE RECOUVRIR TOUT LE FOND INTÉRIEUR D'UNE ÉPAISSE COUCHE D'ALUMINIUM, SANS LAISSER DE CAVITÉS VIDES, POUR OFFRIR UNE DIFFUSION DE LA CHALEUR PLUS RAPIDE ET UNIFORME JUSQU'AUX BORDS DU RÉCIPIENT /

DEUTSCH

ELEGANTER KOCHBEDARF IM ATTRAKTIVEN DESIGN AUS EDELSTAHL, MIT KOMPAKTEM DIFFUSIONSUNTERBODEN, GEEIGNET FÜR INDUKTION. HERGESTELLT MIT EINER HOCHENTWICKELTEN TECHNOLOGIE, ALL-OVER TECHNOLOGY, DIE ES ERLAUBT DIE GANZE INNENSEITE DES UNTERBODENS MIT EINER DICKEN ALUMINIUMSCHICHT AUSZUFÜLLEN, OHNE BLASENENTSTEHUNG, WELCHE EINE SCHNELLE BIS HIN ZU DEN RÄNDERN EINHEITLICHE WÄRMEVERTEILUNG ERLAUBT.

ALL-OVER TECHNOLOGY PROLONGA LA VIDA ÚTIL DE PRODUCTO, EVITANDO QUE SE ACUMULEN DENTRO DEL FONDO DIFUSOR RESTOS DE COMIDA, AGUA O DETERGENTES QUE LO ACABAN DAÑANDO /

ALL-OVER TECHNOLOGY IT PROLONGS THE USEFUL LIFE OF THE PRODUCT, PREVENTING REMAINS OF FOOD, WATER OR DETERGENTS ACCUMULATING IN THE SANDWICH BOTTOM AND EVENTUALLY DAMAGING IT /

ALL-OVER TECHNOLOGY PROLONGE LA DURÉE DE VIE UTILE DU PRODUIT EN ÉVITANT QUE NE S'ACCUMULENT DANS LE FOND DIFFUSEUR DES RESTES DE NOURRITURE, D'EAU OU DE DÉTERGENTS QUI FINISSENT PAR L'ENDOMMAGER /

ALL-OVER TECHNOLOGIE VERLÄNGERT DIE GEBRAUCHSDAUER DES PRODUKTS, SCHLIESST DAS ANLAGERN VON ESSENS-, WASSER- UND REINIGUNGSMITTELRESTEN AM BODEN AUS, WELCHE ES BESCHÄDIGEN.



- INOX / ST/STEEL
ROSTFREIER STAHL
- ALUMINIO / ALUMINIUM
- INOX MAGNÉTICO /
MAGNETIC ST/STEEL /
INOX MAGNÉTIQUE /
MAGNETISCHER
EDELSTAHL



458 Olla con tapa / Stock pot with lid / Marmite traiteur avec couvercle / Kochtopf mit Deckel



REF	Ø cm	H cm	Lts	€	U
458.024	24	20,0	9,00	51,70	1
458.028	28	24,0	14,50	69,45	1

456 Cacerola alta con tapa / Sauce pot with lid / Braisière avec couvercle / Hohe Kasserolle mit Deckel



REF	Ø cm	H cm	Lts	€	U
456.016	16	11,0	2,00	27,45	1
456.020	20	13,0	4,00	35,20	1
456.024	24	14,0	8,50	44,65	1
456.028	28	16,0	12,50	63,15	1
456.032	32	19,0	15,20	70,40	1

457 Cacerola baja con tapa / Casserole with lid / Faitout avec couvercle / Flache Kasserolle mit Deckel



REF	Ø cm	H cm	Lts	€	U
457.016	16	7,5	1,50	24,35	1
457.020	20	8,0	2,50	31,05	1
457.024	24	9,5	4,30	40,90	1
457.028	28	11,0	6,70	55,90	1
457.032	32	12,5	10,00	62,10	1

454 Cazo recto / Saucepan / Casserole / Gerade Stielkasserolle



REF	Ø cm	H cm	Lts	€	U
454.012	12	7,0	0,70	15,05	1
454.014	14	7,0	1,00	16,15	1
454.016	16	7,5	1,50	21,25	1
454.018	18	9,0	2,30	23,85	1
454.020	20	10,0	3,10	27,45	1

459 Sartén / Fry pan / Poêle / Bratpfanne



REF	Ø cm	H cm	€	U
459.018	18	4,0	25,25	1
459.020	20	4,5	28,90	1
459.024	24	5,0	35,85	1
459.028	28	5,5	42,75	1



HOBBY CHEF

INDUCTION

ESPAÑOL

ESPECIALMENTE DISEÑADA PARA EL CHEF EN CASA O PARA PEQUEÑAS COCINAS PROFESIONALES DONDE EL ESPACIO ES CRUCIAL. ESTÁ FABRICADA EN ACERO INOXIDABLE 18/10, PULIDA SATINADA EN SU INTERIOR Y BRILLANTE EN EL EXTERIOR.

ENGLISH

SPECIALLY DESIGNED FOR AN INTENSIVE & PROFESSIONAL USE IN SMALL RESTAURANTS OR EVEN AT HOME. MADE OF 18/10 ST/STEEL STEEL INSIDE SATIN AND OUTSIDE MIRROR FINISH.

FRANÇAIS

SPÉCIALEMENT CONÇUE POUR UNE UTILISATION PROFESSIONNELLE INTENSIVE DANS DES PETITS RESTAURANTS OU AU NIVEAU PARTICULIER. FABRIQUÉE EN ACIER INOXYDABLE 18/10, POLISSAGE SATINÉ À L'INTÉRIEUR ET BRILLANT À L'EXTÉRIEUR.

DEUTSCH

SPEZIELL DESIGNT FÜR DEN CHEFF IM HAUS ODER KLEINE PROFESSIONELLE KÜCHEN, WO DER PLATZ ENTSCHEIDEND IST. HERGESTELLT AUS EDELSTAHL 18/10, INNEN SATINIERT UND AUSSEN GLÄNZEND POLIERT.

411 Olla recta con tapa / Stock pot with lid /
Marmite traiteur avec couvercle /
Gerader Kochtopf mit Deckel



REF	Ø cm	H cm	Lts	€	U
411.524	24	20,0	8,70	62,20	1
411.528	28	24,0	13,60	78,35	1

407 Cacerola baja con tapa / Casserole with lid /
Faitout avec couvercle /
Flache Kasserolle mit Deckel



REF	Ø cm	H cm	Lts	€	U
407.516	16	7,5	1,50	26,15	1
407.520	20	8,0	2,50	36,90	1
407.524	24	9,5	3,90	45,95	1
407.528	28	11,0	5,80	56,55	1
407.532	32	12,5	8,90	76,95	1

408 Cacerola alta con tapa / Sauce pot with lid /
Braisinge avec couvercle /
Hohe Kasserolle mit Deckel



REF	Ø cm	H cm	Lts	€	U
408.516	16	11,0	2,10	31,80	1
408.520	20	13,0	4,00	39,30	1
408.524	24	14,0	5,50	54,25	1
408.528	28	16,0	9,00	70,85	1
408.532	32	19,0	13,30	86,90	1

406 Paellera con tapa / Paella pan with lid /
Plat à paella avec couvercle /
Paellapfanne mit Deckel



REF	Ø cm	H cm	Lts	€	U
406.524	24	6,0	2,70	42,30	1
406.528	28	6,0	3,70	54,35	1

412 Parte superior vaporera / Top for steam pot /
Dessus cuit-vapeur / Oberteil Dampfgerer



REF	Ø cm	H cm	Lts	€	U
412.020	20	13,0	4,00	30,70	1
412.024	24	14,0	5,50	38,45	1

Adaptable a olla y cacerola alta
Adjustable to stock pot and sauce pot
Adaptable à la marmite traiteur et à la braisière
Aufsetzbar auf Kochtopf oder hohe Kasserolle

404 Cazo recto / Saucepan /
Casserole / Gerade Stielcasserolle



REF	Ø cm	H cm	Lts	€	U
404.512	12	7,0	0,70	18,35	1
404.514	14	7,0	1,00	18,85	1
404.516	16	7,5	1,40	21,65	1
404.518	18	9,0	2,10	23,70	1
404.520	20	10,0	3,00	27,35	1

409 Tapa / Lid / Couvercle / Deckel



REF	Ø cm	€	U
409.516	16	9,30	1
409.520	20	10,70	1
409.524	24	14,25	1
409.528	28	17,05	1
409.532	32	22,15	1

410 Sautex / Sauté pan / Sauteuse / Sauteuse



REF	Ø cm	H cm	Lts	€	U
410.524	24	6,0	2,50	35,30	1

305 Colador semiesférico /
Round colander /
Passoire demi-sphérique /
Halbkugelförmiges Sieb



REF	Ø cm	€	U
305.020	20	21,40	1
305.022	22	23,95	1

470 Batería de cocina 8 piezas /
8 pieces kitchenware set /
Batterie de cuisine de 8 pièces /
8 teiliges Kochset



REF	€	U
470.005	247,50	1

Cacerola alta / Saucepot / Braisière / Hohe Kasserolle: 16, 20 cm
Cacerola baja / Casserole / Faitout / Flache Kasserolle: 16, 20, 24 cm
Cazos / Saucepans / Casseroles / Kasserolle: 14, 16 cm
Sautex / Sauté pan / sauteuse / Sauteuse: 24 cm

APARTAMENTO



Olla recta con tapa /
Stock pot with lid /
Marmite traiteur avec couvercle /
Gerader Kochtopf mit Deckel

273



REF	Ø cm	H cm	Lts	€	U
273.024	24	20,0	9,00	47,10	1
273.028	28	24,0	14,50	63,45	1

Cacerola baja con tapa /
Casserole with lid /
Faitout avec couvercle /
Flache Kasserolle mit Deckel

271



REF	Ø cm	H cm	Lts	€	U
271.016	16	7,5	1,50	19,15	1
271.020	20	8,5	2,50	24,35	1
271.024	24	9,5	4,20	33,75	1
271.028	28	11,0	6,50	45,05	1

INDUCTION

ESPAÑOL

BATERÍA ESPECIALMENTE IDEADA PARA EL EQUIPAMIENTO DE APARTAMENTOS, APART-HOTELES Y BUNGALOWS.

ENGLISH

COOKWARE SET ESPECIALLY DESIGNED FOR THE APARTMENTS, APART-HOTELS AND CABIN EQUIPMENT.

FRANÇAIS

BATTERIE DE CUISINE SPÉCIALEMENT CONÇUE POUR ÉQUIPER DES STUDIOS, APPART-HÔTELS ET BUNGALOWS.

DEUTSCH

KOCHBEDARF SPEZIELL DESIGNT VON FÜR DIE AUSSTATTUNG VON APARTEMENTS, APART-HOTELES UND BUNGALOWS.

Cacerola alta con tapa /
Sauce pot with lid /
Braising pot with lid /
Hohe Kasserolle mit Deckel

270



REF	Ø cm	H cm	Lts	€	U
270.016	16	11,0	2,10	21,25	1
270.020	20	14,5	4,50	31,50	1
270.024	24	15,0	6,70	39,95	1
270.028	28	16,0	9,50	52,70	1

Cazo / Saucepan /
Casserole / Stielkasserolle

272



REF	Ø cm	H cm	Lts	€	U
272.014	14	7,5	1,10	12,45	1
272.016	16	8,0	1,50	14,30	1
272.018	18	8,5	2,10	16,70	1
272.020	20	8,5	2,50	18,85	1

460 Sartén aluminio antiadherente. Mango baquelita / Aluminium non-stick fry pan. Bakelite handle /
Poêle aluminium anti-adhésive. Queue en bakélite / Aluminiumbratpfanne Antihaft. Bakelitestiel



REF	Ø cm	H cm	€	U
460.018	18	4,0	7,90	1
460.020	20	4,0	8,80	1
460.022	22	4,0	10,00	1
460.024	24	4,0	10,85	1
460.026	26	4,5	11,55	1
460.028	28	4,5	12,60	1
460.030	30	4,5	14,10	1
460.032	32	5,0	15,75	1

UTENSILIOS DE COCINA / KITCHEN UTENSILS / USTENSILES DE CUISINE / KÜCHENUTENSILIEN

34001
Cacillo /
Ladle /
Louche /
Schöpflöffel

Nylon



REF	L cm	Lts	€	U
340.010	28,5	0,08	1,95	12

34002
Espumadera /
Skimmer /
Écumoire /
Schaumlöffel

Nylon



REF	L cm	Ø cm	€	U
340.020	27	10,7	1,95	12

34003
Cuchara de servicio /
serving spoon /
Cuillère de service /
Servierlöffel

Nylon



REF	L cm	€	U
340.030	27,5	1,95	12

34004
Espátula /
Turner /
Spatule /
Pfannenwender

Nylon



REF	L cm	€	U
340.040	28,5	1,95	12

34005
Espátula wok /
wok spatula /
Spatule wok /
Wokspachtel

Nylon



REF	L cm	€	U
340.050	27,5	1,95	12

34006
Espátula pastelera /
baker spatula /
Palette /
Kuchenheber

Nylon



REF	L cm	€	U
340.060	29	1,95	12

34007
Cuchara espagueti /
spaghetti server /
Cuillère à spaghetti /
Spaghettilöffel

Nylon



REF	L cm	€	U
340.070	29	1,95	12

34008
Tenedor /
Meat fork /
Fourchette /
Fleischgabel

Nylon



REF	L cm	€	U
340.080	29,5	1,95	12

34009
Pinza /
Tong /
Pince /
Zange

Nylon



REF	L cm	€	U
340.090	30,5	1,95	12

33601 Cacillo / ladle / Louche / Schöpflöffel

-40°C +210°C

Inox + Nylon
St/Steel + Nylon
Rostfreier Stahl + Nylon

REF	L cm	Lts	€	U
33601	32	0,08	4,75	12

33602 Espumadera / skimmer /
Écumoire / Schaumlöffel

-40°C +210°C

Inox + Nylon
St/Steel + Nylon
Rostfreier Stahl + Nylon

REF	L cm	Ø cm	€	U
33602	35	11,5	4,60	12

33603 Cuchara de servicio / serving spoon /
Cuillère de service / Servierlöffel

-40°C +210°C

Inox + Nylon
St/Steel + Nylon
Rostfreier Stahl + Nylon

REF	L cm	€	U
33603	34,5	4,60	12

33604 Espátula / turner / Spatule / Pfannenwender

-40°C +210°C

Inox + Nylon
St/Steel + Nylon
Rostfreier Stahl + Nylon

REF	L cm	€	U
33604	35,5	4,60	12

33605 Batidor / whisk / Fouet / Rührbesen

-40°C +210°C

Inox + Nylon
St/Steel + Nylon
Rostfreier Stahl + Nylon

REF	L cm	€	U
33605	32	4,60	12

33606 Pala pasteles / cake server /
Pelle à gateau / Tortenheber

-40°C +210°C

Inox + Nylon
St/Steel + Nylon
Rostfreier Stahl + Nylon

REF	L cm	€	U
33606	38	4,60	12

33607 Cuchara espagueti / spaghetti server /
Cuillère à spaghetti / Spaghettilöffel

-40°C +210°C

Inox + Nylon
St/Steel + Nylon
Rostfreier Stahl + Nylon

REF	L cm	€	U
33607	34,5	4,60	12

33608 Espátula pastelera / baker spatula /
Palette / Kuchenheber

-40°C +210°C

Inox + Nylon
St/Steel + Nylon
Rostfreier Stahl + Nylon

REF	L cm	€	U
33608	32,5	4,60	12

UTENSILIOS DE COCINA / KITCHEN UTENSILS / USTENSILES DE CUISINE / KÜCHENUTENSILIEN

33609 Cacillo salsas / Sauce ladle /
Cuillère à sauces / Sossenlöffel

-40°C +210°C

Inox + Nylon
St/Steel + Nylon
Rostfreier Stahl + Nylon

REF	L cm	Lts	€	U
33609	29	0,02	4,75	12

33610 Espátula wok / Wok spatula /
Spatule wok / Wokschaukel

-40°C +210°C

Inox + Nylon
St/Steel + Nylon
Rostfreier Stahl + Nylon

REF	L cm	€	U
33610	35	4,60	12

33611 Tenedor / Meat fork /
Fourchette / Fleischgabel

-40°C +210°C

Inox + Nylon
St/Steel + Nylon
Rostfreier Stahl + Nylon

REF	L cm	€	U
33611	33,5	4,60	12

33612 Pincel de silicona / Silicone brush /
Pinceau silicone / Silikonpinsel

-40°C +210°C

Inox + Nylon
St/Steel + Nylon
Rostfreier Stahl + Nylon

REF	L cm	€	U
33612	29,5	4,60	12

33613 Espátula pescado / Fish turner /
Pelle à poisson / Fischwender

-40°C +210°C

Inox + Nylon
St/Steel + Nylon
Rostfreier Stahl + Nylon

REF	L cm	€	U
33613	35,5	4,60	12

33614 Pinza / Tong / Pince / Zange

-40°C +210°C

Inox + Nylon
St/Steel + Nylon
Rostfreier Stahl + Nylon

REF	L cm	€	U
33614	34,5	5,60	12

33620 Recipiente utensilios / Utensil holder / Porte ustensiles / Behälter für Küchenhelfer

REF	Ø cm	H cm	€	U
33620	13,5	19,0	4,60	12

Utensilios no incluidos
Utensils not included
Ustensiles non inclus
Küchenhelfer nicht inklusive

UTENSILIOS DE COCINA / KITCHEN UTENSILS / USTENSILES DE CUISINE / KÜCHENUTENSILIEN

32902 Abridor de botellas y latas / Bottle and can opener / Ouvre bouteilles et boîtes / Flaschen- und Dosenöffner

REF	L cm	€	U
32902	17	4,95	12

32903 Racionador helado / Ice cream scoop / Cuillère à glace / Eisportionierer

REF	L cm	€	U
32903	19	4,95	12

32904 Cuchillo para untar / Butter spreader / Couteau à beurre / Aufstrichlöffel

REF	L cm	€	U
32904	21	4,95	12

32905 Descorazonador manzanas / Apple corer / Vide-pommes / Apfelentkerner

REF	L cm	€	U
32905	20	4,65	12

32906 Pala para quesos / Cheese slicer / Couteau à fromage / Käsehobel

REF	L cm	€	U
32906	21,5	4,95	12

32907 Pala pasteles / Cake spatula / Pelle à gateau / Keksschaufel

REF	L cm	€	U
32907	27,5	4,95	12

32908 Pelador patatas / Potato peeler / Eplucheur / Sparschäler

REF	L cm	€	U
32908	19,5	4,65	12

32909 Pelador universal / Universal peeler / Eplucheur universel / Universalschäler

REF	L cm	€	U
32909	17	4,65	12

32910 Plantilla cortarodajas y pinchacarnes / Onion fork / Fourchette à oignons / Zwiebelschneider und Fleischstecher

REF	L cm	€	U
32910	21	4,95	12

32911 Prensa ajos / Garlic press / Press-ail / Knoblauchpresse

REF	L cm	€	U
32911	18,5	7,95	12

32912 Rallador / Grater / Râpe / Reibe

REF	L cm	€	U
32912	25	4,65	12

32913 Cortador bolas / Fruit baller / Cuillère à pommes / Kugelschneider

REF	L cm	€	U
32913	16	4,65	12

32920 Soporte para 12 gadgets / Rack for 12 gadgets / Support pour 12 gadgets / Ständer für 12 Küchenhelfer

REF	cm	H cm	€	U
32920	23,5 x 15	34,5	7,95	12

Utensilios de cocina no incluidos.
Kitchen utensils non included.
Ustensils pas compris.
Küchenhelfer nicht inklusive

ACCESORIOS SILICONA / SILICONE ACCESSORIES / ACCESSOIRES SILICONE / SILIKONACCESSORIES

37318

Colador extensible silicona /
Silicone colander collapsible /
Passoire silicone pliant /
Faltbarer Silikonseihler



REF	Ø cm	H cm	€	U
37318	18	11,0	17,45	1

2355

Co-cotte silicona /
Co-cotte silicone /
Co-cotte silicone /
Co-cotte Silikon



Microondas /
Micro-wave /
Microondes /
Mikrowelle

Cocina al vapor /
Steammer /
Cuit-vapeur /
Dampfgarer

REF	mm	H mm	€	U
23550	230 x 100	53,0	15,75	1
23551	265 x 115	85,0	25,15	1
23552	335 x 145	100,0	39,85	1

VER PRODUCTOS EN / SEE PRODUCTS ON / VOIR PRODUITS EN / SIEHE PRODUKTE IN



VER PRODUCTOS EN / SEE PRODUCTS ON / VOIR PRODUITS EN / SIEHE PRODUKTE IN



P. 77



P. 82



P. 83



P. 87



P. 198



P. 210



P. 233



P. 269



P. 271

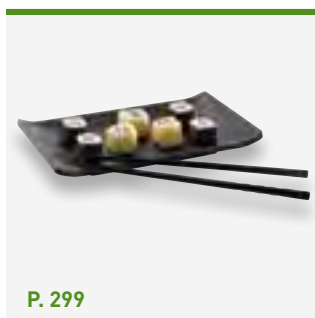

P. 299



P. 319



P. 324



P. 328



P. 335

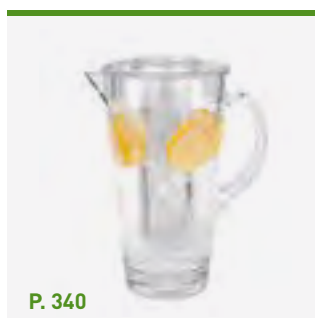

P. 340



P. 342



P. 366



P. 379



P. 389



P. 399

BATERIA CUCINA FOODIES /
FOODIES COOKWARE /
BATTERIE CUISINE FOODIES



TRANSPORTE Y ALMACENAMIENTO / TRANSPORT AND STORAGE / TRANSPORT ET STOCKAGE / TRANSPORT UND LAGERUNG

3.1 CUBETAS GASTRONORM / GASTRONORM CONTAINERS / BACS GASTRONORME / GASTRONORM BEHÄLTER 116

INOX 18/10 / 18/10 ST/STEEL / INOX 18/10 / EDELSTAHL 18/10	122
COMPLEMENTOS GASTRONORM / GASTRONORM ACCESSORIES / ACCESSOIRES GASTRONORME / GASTRONORM ASSESSOIRES	126
CON FONDO DIFUSOR / WITH SANDWICH BOTTOM / AVEC FOND THERMO-DIFFUSEUR / EDELSTAHL 18/10 SANDWICHBODEN	127
POLICARBONATO / POLYCARBONATE / POLYCARBONATE / POLYCARBONAT	128
SIN BISFENOL-A / BISPHENOL-A FREE / SANS BISPHÉNOL-A / OHNE BISFENOL-A	130
POLIPROPILENO / POLYPROPYLENE / POLYPROPYLÈNE / POLYPROPYLEN	132

3.2 CESTAS PARA VAJILLA / DISHWASHER RACKS / CASIERS À VAISSELLE / SPÜLMASCHINENKÖRBE 136

CESTAS BASE Y SUPLEMENTOS / RACKS AND EXTENDERS / PANIERS BASE ET RÉHAUSSE / BASISKÖRBE UND ERWEITERUNGEN	138
COMPLEMENTOS / COMPLEMENTS / COMPLÈMENTS/ ZUBEHÖR	142
CESTAS PARA PLATOS / PLATE RACKS / CASIERS ASSIETTES / TELLERSPÜLKÖRBE	143

3.3 CARROS / TROLLEYS / CHARIOTS / SERVIERWAGEN 148

CARROS DE SERVICIO EN MADERA / WOODEN SERVING TROLLEYS / CHARIOTS DE SERVICE EN BOIS / SERVIERWAGEN AUS HOLZ	148
CARROS DE SERVICIO ALUMINIO / ALUMINIUM SERVING TROLLES / CHARIOTS DE SERVICE EN ALUMINIUM / SERVICEWAGEN AUS ALUMINIUM	152
CARROS DE SERVICIO ACERO INOXIDABLE / ST/STEEL SERVING TROLLEYS / CHARIOTS DE SERVICE EN ACIER INOXYDABLE / SERVIERWAGEN AUS EDELSTAHL	153
CARROS GUÍAS EN ACERO INOXIDABLE / ST/STEEL RAIL TROLLEYS / CHARIOTS À GLISSIÈRES EN ACIER INOXYDABLE / SERVIERWAGEN MIT EINSCHÜBEN AUS EDELSTAHL	156
CARROS ESPECIALES / SPECIAL TROLLEYS / CHARIOTS SPÉCIAUX / SPEZIALWAGEN	165

3.4 ESTANTERÍAS / SHELVING / ÉTAGÈRES / REGALE 168

COMPONENTES ESTANTERÍA / SHELVING PARTS / COMPONENTS ÉTAGÈRES / REGAL KOMponentEN	172
KIT ESTANTERÍA / SHELVING KITS / KITS ÉTAGÈRES / REGAL SETS	175

CUBETAS GASTRONORM / GASTRONORM CONTAINERS / BACS GASTRONORME / GASTRONORM BEHÄLTER

ESPAÑOL

CONFORME A LA NORMA EN-631.2 PUJADAS OFRECE UNA DE LAS GAMAS DE CUBETAS GASTRONORM DE FABRICACIÓN PROPIA MÁS AMPLIA DEL MERCADO

ENGLISH

ACCORDING TO EN-631.2 PUJADAS OFFERS ONE OF THE MOST SPECIALIZED RANGES, IN-HOUSE MANUFACTURING, OF GASTRONORM CONTAINERS IN THE MARKET

FRANÇAIS

SUIVANT LA NORME EN-631.2 PUJADAS PROPOSE UNE DES GAMMES DE BACS GASTRONORME DE PROPRE FABRICATION DES PLUS SPÉCIALISÉS DU MARCHÉ

DEUTSCH

ENTSPRECHEND DER NORM EN-631.2 BIETET PUJADAS AUS EIGENER HERSTELLUNG EINE DER BREITESTEN PRODUKTPALLETTE IM HANDEL AN.

ACERO INOXIDABLE / ST/STEEL / ACIER INOXYDABLE / ROSTFREIER STAHL



BORDES REFORZADOS /
REINFORCED EDGES /
BORDS RENFORCÉS /
VERSTÄRKTÉ RÄNDER

-18/10

GEOMETRÍA ADAPTADA: + LIMPIEZA + CAPACIDAD /
RADIUS SPECIALLY DESIGNED FOR: + CAPACITY + CLEANING /
GÉOMÉTRIE ADAPTÉE: + PROPRIÉTÉ + CAPACITÉ /
RADIUS SPEZIELL DESIGNT: + KAPAZITÄT + REINIGUNG

POLICARBONATO / POLICARBONATO / POLYCARBONATE / POLYCARBONAT

TEMPERATURA DE -40 °C HASTA + 130 °C /
TEMPERATURES FROM -40 °C TO + 130 °C /
TEMPÉRATURES DE -40 °C À + 130 °C /
TEMPERATUREN VON -40 °C BIS + 130 °C

TEXTURA PARA EVITAR RALLADAS /
TEXTURING CORNERS TO AVOID SCRATCHING /
CÔTÉS GRANITÉS POUR ÉVITER RAYURES /
STRUKTUR UM VERKRATZUNGEN ZU VERHINDERN

MARCAJE MODELO CUBETA /
CONTAINER MODEL /
TYPE DE BAC /
MODELMARKIERUNG AM BEHÄLTER

BORDES REFORZADOS /
REINFORCED RIMS /
BORDS RENFORCÉS /
VERSTÄRKTÉ RÄNDER



MAYOR GROSOR /
THICKER /
PLUS ÉPAIS /
DICKER

GRADUACIÓN EXTERNA DE CAPACIDAD /
GRADUATIONS MARKED EXTERNALLY /
ÉCHELLE DE GRADUATIONS À L'EXTÉRIEUR /
EXTERNE SKALIERUNG DES FASSUNGSVERMÖGEN

CARACTERÍSTICAS MARCADAS EN EL FONDO /
MAIN FEATURES MARKED ON THE BASE /
CARACTERISTIQUES MARQUÉS AU FOND /
EIGENSCHAFTEN IM BODEN MARKIERT

SIN BISFENOL-A / BISPHENOL-A FREE / SANS BISPHÉNOL-A / OHNE BISFENOL-A

TEMPERATURAS DE -40°C HASTA +90°C
TEMPERATURES FROM -40°C TO +90°C
TEMPÉRATURES DE -40°C À +90°C
TEMPERATUREN VON -40°C BIS +90°C



POLIPROPILENO / POLYPROPYLENE / POLYPROPYLENE / POLYPROPYLEN

TEMPERATURA DE -40 °C HASTA + 110 °C /
TEMPERATURES FROM -40 °C TO + 110 °C /
TEMPÉRATURES DE -40 °C À + 110 °C /
TEMPERATUREN VON -40 °C BIS + 110 °C

TEXTURA PARA EVITAR RALLADAS /
TEXTURING CORNERS TO AVOID SCRATCHING /
CÔTÉS GRANITÉS POUR ÉVITER RAYURES /
STRUKTUR UM KRATZER ZU VERHINDERN

HERMÉTICO CON TAPA POLINORM /
HERMETIC WITH POLINORM LID /
HERMETIQUE AVEC COUVERCLE POLINORM /
HERMETISCH MIT POLINORM DECKEL

BORDES REFORZADOS /
REINFORCED RIMS /
BORDS RENFORCÉS /
VERSTÄRKTÉ RÄNDER

MARCAJE MODELO CUBETA /
CONTAINER MODEL /
TYPE DE BAC /
MODELMARKIERUNG AM BEHÄLTER

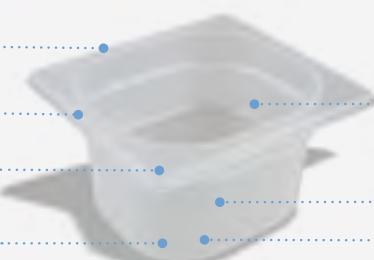

MAYOR GROSOR /
THICKER /
PLUS ÉPAIS /
DICKER

GRADUACIÓN EXTERNA DE CAPACIDAD /
GRADUATIONS MARKED EXTERNALLY /
ÉCHELLE DE GRADUATIONS À L'EXTÉRIEUR /
EXTERNE SKALIERUNG DES FASSUNGSVERMÖGEN

CARACTERÍSTICAS MARCADAS EN EL FONDO /
MAIN FEATURES MARKED ON THE BASE /
CARACTERISTIQUES MARQUÉS AU FOND /
EIGENSCHAFTEN IM BODEN MARKIERT

COCCIÓN /
COOKING /
CUISSON /
KOCHEN

PATENTED EXCLUSIVE



GN CON FONDO DIFUSOR /
GN PAN WITH SANDWICH BASE /
BAC GN AVEC FOND THERMO-DIFFUSEUR /
GN BACKFORM MIT SANDWICHBODEN



GN ALUMINIO ANTIADHERENTE /
NON-STICK ALUMINIUM GN PAN /
BAC GN ANTI-ADHÉSIF EN ALUMINIUM /
GN BACKFORM ALUMINIUM ANTIHAFT



BANDEJAS GN ESPECIAL HORNO /
SPECIAL OVEN GN PANS /
PLAQUES SPÉCIALES GN POUR FOUR /
SPEZIELLE GN OFENFORMEN

TRANSPORTE /
TRANSPORT /
TRANSPORT /
TRANSPORT



GN INOX + TAPA INOX HERMÉTICA /
ST/STEEL GN + ST/STEEL HERMETIC LID /
BAC GN INOX + COUVERCLE ÉTANCHE INOX /
GN EDELSTAHL + EDELSTAHLDECKEL HERMETISCH

TEMP. 120°C

HERMÉTICO / HERMETIC
ÉTANCHE / HERMETISCH



POLICARBONATO O CUBETA SIN BISFENOL-A + TAPA POLINORM /
POLYCARBONATE OR BPA FREE + POLINORM LID /
POLYCARBONAT OUI SANS BPA + COUVERCLE POLINORM /
POLYCARBONAT ODER OHNE BISFENOL-A BEHÄLTER + POLINORMDECKEL

TEMP. 100°C



GN POLIPROPILENO + TAPA POLINORM® /
POLYPROPYLENE + POLINORM® LID /
GN POLYPROPYLENE + COUVERCLE POLINORM® /
GN POLYPROPYLEN + POLINORM® DECKEL

TEMP. 90°C

HERMÉTICO / HERMETIC
ÉTANCHE / HERMETISCH

ALMACENAMIENTO /
STORAGE /
STOCKAGE /
LAGERUNG



GN POLICARBONATO + TAPA POLICARBONATO /
POLYCARBONATE GN + POLYCARBONATE LID /
GN POLYCARBONATE + COUVERCLE POLYCARBONATE /
GN POLYCARBONAT + POLYCARBONAT DECKEL



GN POLICARBONATO + TAPA POLINORM® /
POLYCARBONATE GN + POLINORM® LID /
GN POLYCARBONATE + COUVERCLE POLINORM® /
GN POLYCARBONAT + POLINORM® DECKEL



GN POLIPROPILENO + TAPA POLINORM® /
POLYPROPYLENE + POLINORM® LID /
GN POLYPROPYLENE + COUVERCLE POLINORM® /
GN POLYPROPYLEN + POLINORM® DECKEL

PRESENTACIÓN /
DISPLAY /
PRÉSENTATION /
PRÄSENTATION



GN POLICARBONATO + TAPA POLICARBONATO /
POLYCARBONATE GN + POLYCARBONATE LID /
GN POLYCARBONATE + COUVERCLE POLYCARBONATE /
POLYCARBONAT GN + POLYCARBONAT DECKEL



GN POLICARBONATO + TAPA POLICARBONATO /
POLYCARBONATE GN + POLYCARBONATE LID /
GN POLYCARBONATE + COUVERCLE POLYCARBONATE /
POLYCARBONAT GN + POLYCARBONAT DECKEL

GN INOX CON FONDO DIFUSOR + TAPA POLICARBONATO /
ST/STEEL GN WITH SANDWICH BASE + POLYCARBONATE LID /
GN INOX AVEC FOND THERMO-DIFFUSEUR + POLYCARBONATE /
EDELSTAHL GN MIT SANDWICHBODEN + POLYCARBONAT DECKEL



GN MELAMINA /
MELAMINE GN /
GN MÉLAMINE /
MELAMIN GN

VER PÁGINA 290 /
REFER TO PAGE 290 /
VOIR PAGE 290 /
SIEHE SEITE 290

SELECCIÓN CUBETAS GASTRONORM / GASTRONORM CONTAINERS SELECTION /
SELECTION BACS GASTRONORME / AUSWAHLÜBERSICHT GASTRONORM BEHÄLTERINOX 18/10 /
18/10 ST/STEEL /
INOX 18/10 /
EDELSTAHL 18/10INOX 18/10 FONDO DIFUSOR /
18/10 ST/STEEL SANDWICH BOTTOM /
INOX 18/10 FOND THERMO-DIFFUSEUR /
EDELSTAHL 18/10 SANDWICHBODENALUMINIO ANTIADHERENTE /
NON-STICK ALUMINIUM /
ALUMINIUM ANTI-ADHÉSIF /
ALUMINIUM ANTIHAFT

NSF®



NSF®

VER PÁGINA 52 / REFER TO PAGE 52 /
VOIR PAGE 52 / SIEHE SEITE 52

PRESENTACIÓN / APPEARANCE / PRÉSENTATION / PRÄSENTATION	✓	●	●
RESISTENCIA / ROBUSNESS / ROBUSTESSE / RESISTENZ	✓	✓	●
ALMACENAMIENTO / STORAGE / STOCKAGE / LAGERUNG	✓	●	✗
BAÑO-MARIA / BAIN MARIE / BAIN-MARIE / WASSERBAD	✓	✓	●
TEMPERATURA MAX / TEMPERATURE MAX / TEMPÉRATURE MAX. / MAX. TEMPERATUR	✓	✓	✓
HORNO / OVEN / FOUR / OFEN	✓	✓	✓
MICROONDAS / MICRO-WAVE / MICRO-ONDES / MIKROWELLE	✗	✗	✗
COCCIÓN / COOKING / CUISSON / KOCHEN	●	✓	✓
INDUCCIÓN / INDUCTION / INDUCTION / INDUKTION	✗	✓	✗
TRANSPORTE EN CALIENTE / WARM TRANSPORTATION / TRANSPORT CHAUD / WARMER TRANSPORT	✓	✓	●
TAPA POLINORM / POLINORM LID / COUVERCLE POLINORM / POLINORM DECKEL	✓	✓	✗

✓ RECOMENDADO / RECOMMENDED / RECOMMANDÉ / EMPFOHLEN

● ACEPTABLE / SUITABLE / ACCEPTABLE / ANNEHMBAR

✗ NO RECOMENDADO / NOT RECOMMENDED / PAS RECOMMANDÉ / NICHT EMPFOHLEN

SELECCIÓN CUBETAS GASTRONORM / GASTRONORM CONTAINERS SELECTION / SELECTION BACS GASTRONORME / AUSWAHLÜBERSICHT GASTRONORM BEHÄLTER

POLICARBONATO /
POLYCARBONATE /
POLYCARBONATE /
POLYCARBONAT

SIN BISFENOL-A /
BISPHENOL-A FREE /
SANS BISPHÉNOL-A /
OHNE BISFENOL-A

POLIPROPILENO /
POLYPROPYLENE /
POLYPROPYLENE /
POLYPROPYLEN

MELAMINA* /
MELAMINE* /
MÉLAMINE* /
MELAMIN*



VER PÁGINA 290 / REFER TO PAGE 290 /
VOIR PAGE 290 / SIEHE SEITE 290

●	●	●	✓
✓	✓	●	✓
✓	✓	●	●
●	●	✗	●
130 °C	90 °C	110 °C	70 °C
130 °C	✗	✗	✗
✓	✓	✓	✗
✗	✗	✗	✗
✗	✗	✗	✗
130 °C	80 °C	✗	70 °C
✓	✓	✓	✗

* AMBIENTE HÚMEDO / HUMID ENVIRONMENT / ENVIRONNEMENT HUMIDE / FEUCHTE UMGEBUNG

MEDIDAS Y COMBINACIONES / SIZES AND COMBINATIONS / MESURES ET COMBINAISONS / MASSE UND KOMBINATIONEN

COMBINACIONES / COMBINATIONS / COMBINAISONS / KOMBINATIONEN



MEDIDAS DE ENCASTE / FITTING MEASURES / MESURES D'EMBOÎTEMENT / MASSE DER EINSETZLÖCHER

Modelo	"A"	"B"
2/1	630	510
1/1	510	305
2/3	333	305
1/2	305	245
1/3	305	155
1/4	245	142
1/6	156	142
1/9	156	88

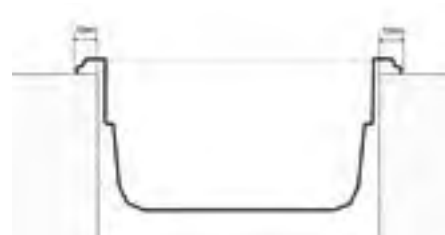
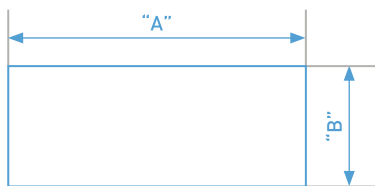

**TAPA GN POLINORM® /
GN POLYNORM® LID /
GN COUVERCLE POLYNORM® /
GN POLYNORM® DECKEL**

PATENTED EXCLUSIVE



**DISPONIBLE EN CINCO COLORES / AVAILABLE IN FIVE COLOURS /
DISPONIBLE EN CINQ COULEURS / IN FÜNF FARBEN VERFÜGBAR**



ADAPTABLES A / ADJUSTABLES TO / ADAPTABLE À / PASSEND ZU

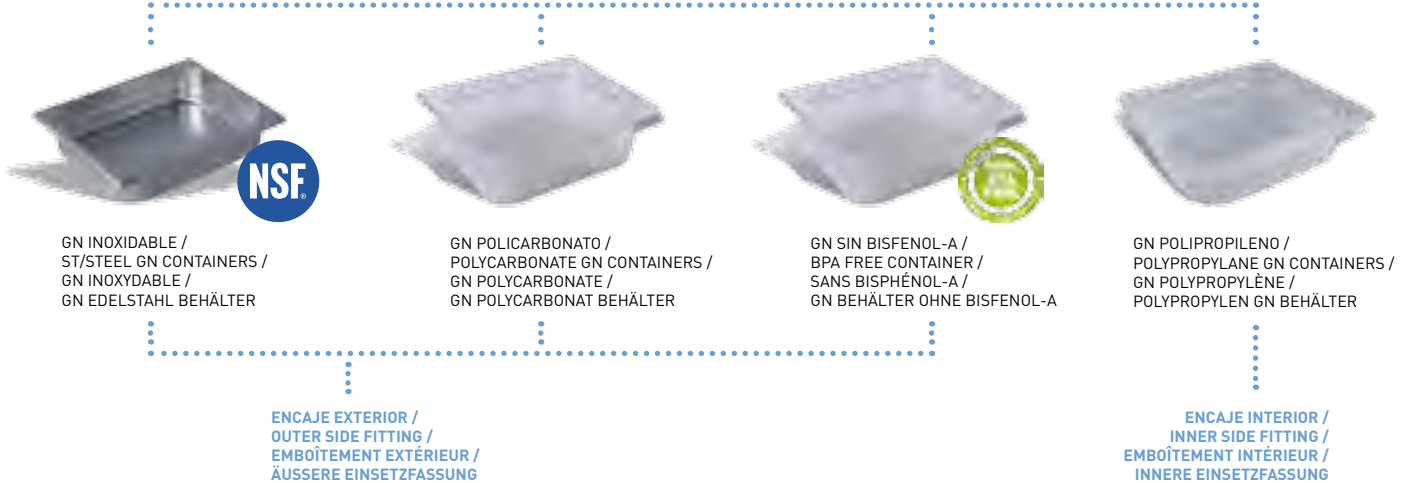

TAPA POLINORM / POLYNORM LID / COUVERCLE POLYNORM / POLYNORM DECKEL

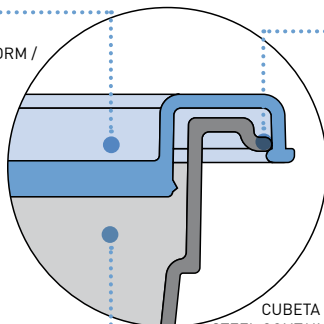

CLIPS PARA CIERRE CUBETA INOX Y PC / FLAPS TO FIT WITH GN INOX AND PC / RAINURES POUR CLIPSER BACS GN INOX ET PC / VERSCHLUSSKLEMME FÜR EDELSTAHL UND PC BEHÄLTER

CUBETA INOX / POLICARBONATO / STEEL CONTAINER / POLYCARBONATE / BAC INOX / POLYCARBONATE / EDELSTAHL / POLYCARBONAT BEHÄLTER

TAPA POLINORM / POLYNORM LID / COUVERCLE POLYNORM / POLYNORM DECKEL

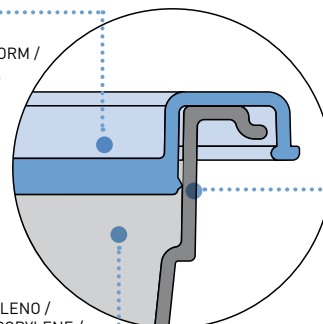

CIERRE HERMÉTICO PARA CUBETAS DE PP / HERMETICAL FOR PP CONTAINERS / HERMETIQUE SUR BACS PP / HERMETISCHER VERSCHLUSS FÜR BEHÄLTER AUS PP

CUBETA POLIPROPILENO / CONTAINER POLYPROPYLENE / BAC POLYPROPYLENE / POLYPROPYLEN BEHÄLTER

**GASTRONORM INOX 18/10 / 18/10 ST/STEEL GASTRONORM /
GASTRONORME INOX 18/10 / GASTRONORM EDELSTAHL 18/10**
2/1 650 x 530 mm

18/10



REF	H mm	Lts	€	U
210.201	20	6,20	37,20	1
210.401	40	11,50	41,95	1
210.651	65	18,80	47,70	1
211.001	100	28,90	59,05	1
211.501	150	43,10	72,65	1
212.001	200	52,00	92,50	1

1/1 530 x 325 mm

18/10



REF	H mm	Lts	€	U
110.201	20	2,80	18,05	1
110.401	40	5,10	20,25	1
110.551	55	7,00	21,80	1
110.651	65	8,30	22,60	1
111.001	100	14,20	29,90	1
111.501	150	20,20	39,20	1
112.001	200	26,00	47,50	1

2/3 353 x 325 mm

18/10

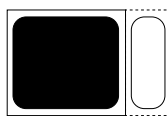

REF	H mm	Lts	€	U
230.201	20	1,70	15,80	1
230.401	40	3,10	20,65	1
230.651	65	5,60	23,60	1
231.001	100	8,80	28,75	1
231.501	150	13,20	40,85	1
232.001	200	18,30	54,30	1

1/2 325 x 265 mm

18/10

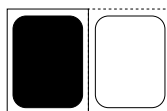

REF	H mm	Lts	€	U
120.201	20	1,20	11,75	1
120.401	40	2,20	13,60	1
120.651	65	4,10	15,90	1
121.001	100	6,10	20,75	1
121.501	150	9,10	25,75	1
122.001	200	12,00	34,25	1

2/4 530 x 165 mm

18/10



REF	H mm	Lts	€	U
240.401	40	1,80	20,75	1
240.651	65	4,00	22,30	1
241.001	100	6,00	27,75	1
241.501	150	10,00	37,30	1

1/3 325 x 176 mm

18/10

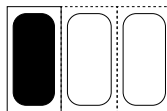

REF	H mm	Lts	€	U
130.201	20	0,80	11,55	1
130.401*	40	1,50	11,95	1
130.651	65	2,50	12,95	1
131.001	100	3,80	16,90	1
131.501	150	5,60	25,85	1
132.001	200	7,30	29,90	1

IDEA!

- * Cubeta GN especial para vitrinas mostrador snack.
- * Special GN container for snack showcases.
- * Bac GN spécial pour vitrines snack.
- * Spezial GN Behälter für Snackglasvitrinen

GASTRONORM INOX 18/10 / 18/10 ST/STEEL GASTRONORM / GASTRONORME INOX 18/10 / GASTRONORM EDELSTAHL 18/10

1/4 265 x 162 mm

18/10

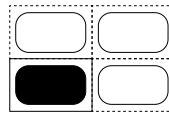

REF	H mm	Lts	€	U
140.201	20	0,50	9,10	1
140.651	65	1,70	11,55	1
141.001	100	2,80	14,70	1
141.501	150	4,10	20,75	1
142.001	200	5,00	27,85	1

1/6 176 x 162 mm

18/10

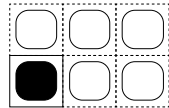

REF	H mm	Lts	€	U
160.651	65	1,00	11,25	1
161.001	100	1,60	13,50	1
161.501	150	2,20	20,45	1
162.001	200	2,90	25,35	1

1/9 176 x 108 mm

18/10

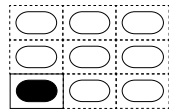

REF	H mm	Lts	€	U
190.651	65	0,60	8,20	1
191.001	100	0,80	12,25	1

Fondos perforados para cubetas / Perforated bottoms for containers / Egouttoirs pour bacs / Gelochte Böden für Behälter



REF	Mod	€	U
215.000	2/1	76,05	1
115.000	1/1	37,40	1
235.000	2/3	33,05	1
125.000	1/2	25,15	1
135.000	1/3	19,05	1
145.000	1/4	15,90	1

Perfiles divisorios / Adaptable bars / Barrettes de composition / Profilstege



REF	Mod	L cm	€	U
111.111	1/1	53	7,50	1
122.222	1/2	32,5	5,35	1

Para realizar cualquier composición con las cubetas gastronorm.
To arrange any composition with gastronorm containers.
Pour réaliser toute composition avec les bacs gastronorme.
Für die Realisierung aller Kombinationen mit den GN Behälter.

Asas móviles / Falling handles / Anses tombantes / Fallgriffe

Añadir AM a la referencia de la cubeta elegida
Add AM to the GN container reference
Ajouter AM à la référence du bac GN
Fügen Sie die AM zu den ausgewählten Art.Nr. der GN

Apta para todas las medidas de cubetas
Suitable for all GN sizes
Apte sur toutes les dimensions GN
Einsetzbar an alle Größen der Behälter



	€	U
Precio cubeta / Container price / Prix bac / Behälterpreis	+ 6	1

Asas fijas / Fixed handles / Anses fixes / Feste Griffe

Añadir AF a la referencia de la cubeta elegida
Add AF to the GN container reference
Ajouter AF à la référence du bac GN
Fügen Sie die AF zu den ausgewählten Art.Nr. der GN

Sólo para cubetas 1/2, 1/3, 1/4 y 1/6
Only for containers 1/2, 1/3, 1/4 and 1/6
Seulement pour bacs 1/2, 1/3, 1/4 et 1/6
Nur für Behälter 1/2, 1/3, 1/4 und 1/6



	€	U
Precio cubeta / Container price / Prix bac / Behälterpreis	+ 4	1

GASTRONORM INOX 18/10 / 18/10 ST/STEEL GASTRONORM /
GASTRONORME INOX 18/10 / GASTRONORM EDELSTAHL 18/10

2/1 650 x 530 mm

18/10

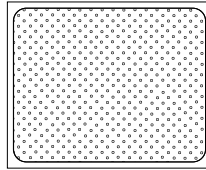

REF	H mm	€	U
210.202	20*	49,15	1
210.402	40*	51,85	1
210.652	65*	65,85	1
211.002	100**	81,55	1
211.502	150**	114,90	1
212.002	200**	140,75	1

1/1 530 x 325 mm

18/10

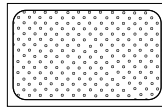

REF	H mm	€	U
110.202	20*	30,50	1
110.402	40*	33,75	1
110.552	55*	34,65	1
110.652	65*	38,00	1
111.002	100**	48,95	1
111.502	150**	74,15	1
112.002	200**	85,40	1

2/3 353 x 325 mm

18/10

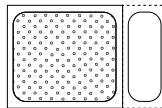

REF	H mm	€	U
230.202	20*	23,30	1
230.402	40*	25,85	1
230.652	65*	31,70	1
231.002	100**	45,20	1
231.502	150**	60,80	1
232.002	200**	65,25	1

1/2 325 x 265 mm

18/10

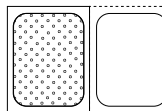

REF	H mm	€	U
120.652	65*	27,95	1
121.002	100**	34,45	1
121.502	150**	46,60	1
122.002	200**	66,65	1

1/3 325 x 176 mm

18/10

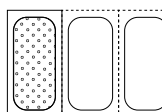

REF	H mm	€	U
130.202	20*	19,45	1
130.402	40*	22,20	1
130.652	65*	24,00	1
131.002	100**	37,50	1
131.502	150**	41,85	1
132.002	200**	52,30	1

* Fondo perforado
* Perforated bottom
* Fond perforé
* Gelochter Boden

** Fondo y laterales perforados
** Perforated bottom and sides
** Fonds et latéraux perforés
** Boden und Seiten gelocht

GASTRONORM INOX 18/10 / 18/10 ST/STEEL GASTRONORM / GASTRONORME INOX 18/10 / GASTRONORM EDELSTAHL 18/10

Tapa Polinorm® / Polinorm® Lid / Couvercle Polinorm® / Polinorm® Deckel

PATENTED EXCLUSIVE



REF	Mod	€	U
1100 + COLOR	1/1	9,30	30
1200 + COLOR	1/2	5,60	60
1300 + COLOR	1/3	4,85	30
1400 + COLOR	1/4	3,95	30
1600 + COLOR	1/6	3,50	60
1900 + COLOR	1/9	3,10	30

Ref. color tapa /
Ref. colour lid /
Ref. couleur couvercle /
Art.Nr. Deckelfarbe



Adaptable a / Adjustable to / Adaptable à / Einsetzbar:

Cubetas GN inox, PC, sin Bisfenol-A y PP /
St/Steel, PC, without Bisphenol-A and PP GN containers /
Bacs GN inox, PC, sans Bisphénol-A et PP /
GN Behälter rostfrei, PC, ohne Bisfenol-A und PP

Tapa / Lid / Couvercle / Deckel

18/10



REF	Mod	€	U
110.000	1/1	21,05	1
230.000	2/3	17,95	1
120.000	1/2	12,25	1
130.000	1/3	10,75	1
140.000	1/4	8,50	1
160.000	1/6	7,10	1
190.000	1/9	6,20	1

Tapa plana sin asa / Flat lid without handle / Couvercle plat sans anse / Flacher Deckel ohne Griff



REF	Mod	€	U
110.005	1/1	25,50	1
120.005	1/2	18,10	1

Tapa hermética / Hermetic lid / Couvercle étanche / Hermetischer Deckel

18/10



Detalle silicona
Silicone joint
Joint silicone
Detail Silikon



REF	Mod	€	U
110.004	1/1	70,00	1
120.004	1/2	51,65	1
130.004	1/3	42,75	1
140.004	1/4	38,20	1
160.004	1/6	38,20	1

Tapa orificio asas / Lid with splits for handles / Couvercle avec encoche pour anses / Deckel mit Öffnung für Griffe

18/10



REF	Mod	€	U
110.001	1/1	26,75	1
230.001	2/3	15,60	1
120.001	1/2	13,60	1
130.001	1/3	10,85	1
140.001	1/4	9,00	1
160.001	1/6	7,80	1

Tapa orificio cacillo / Lid with split for ladle / Couvercle avec encoche pour louche / Deckel mit Öffnung für Löffel

18/10



REF	Mod	€	U
110.002	1/1	28,05	1
120.002	1/2	14,30	1
130.002	1/3	11,45	1
140.002	1/4	9,40	1
160.002	1/6	8,20	1

COMPLEMENTOS GASTRONORM / GASTRONORM ACCESSORIES /
ACCESSOIRES GASTRONORME / GASTRONORM ASSESSOIRES

100002 Presentador 6 cubetas GN 1/6 inox / St/Steel stand 6 slots GN 1/6
Support bacs pour 6 GN 1/6 inox / Edelstahl Ständer für 6 GN Behälter 1/6



REF	€	U
100.002	111,45	1

No incluye cubetas
Containers not included
Bacs non inclus
Behälter nicht inklusive

100004 Presentador cubetas GN / Stand for GN containers /
Support pour bacs GN / Ständer für GN Behälter



REF	€	U
100.004	43,05	1

REF	CONJUNTO / SET / LOT / SET	€	U
100.005	6 - GN 1/9 65 mm	147,40	1
100.006	6 - GN 1/9 100 mm	159,55	1
100.007	4 - GN 1/6 65 mm	104,65	1
100.008	4 - GN 1/6 100 mm	113,80	1

Permiten sostener / It can contain /
Il peut contenir / Einsetzmöglichkeiten

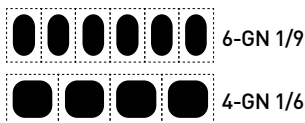

6-GN 1/9 En profundidades 65 y 100 mm
65 or 100 mm deep
Profondeurs 65 ou 100 mm
In Tiefen von 65 und 100 mm

Adaptable a cubetas GN policarbonato y polipropileno
Adjustable to GN container in polycarbonate and polypropylene
Adapté à bacs GN en polycarbonate et polypropylène
Passend für GN Behälter aus Polycarbonat und Polypropylen

100003 Soporte para tapas GN / Stand for GN lids /
Support pour couvercles GN / Ständer für GN Deckel

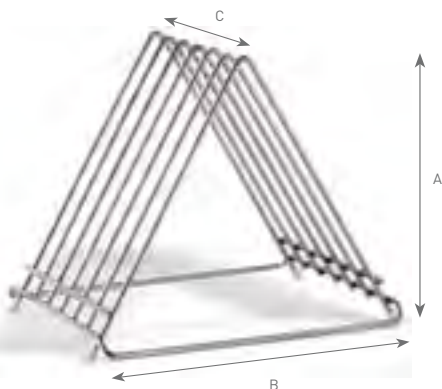

REF	A cm	B cm	C cm	€	U
100.003	27	31	27	28,55	1

Para 6 tapas Distancia entre varillas 2,5 cm
For 6 lids Distance between wires 2,5 cm
Pour 6 couvercles Distance entre fils 2,5 cm
Für 6 Deckel Abstand zwischen den Stäben 2,5 cm

IDEA!

Ideal para tablas de corte. Ver página 79-81
Perfect for cutting boards. Refer to page 79-81
Ideal pour planches à découper. Voir page 79-81
Ideal für Schneidbretter. Siehe Seiten 79-81

VER PRODUCTOS EN / SEE PRODUCTS ON / VOIR PRODUITS EN / SIEHE PRODUKTE IN

BANDEJA GN ANTIADHERENTE /
NON-STICK GN PAN TRAY /
PLAQUE GN ANTI-ADHÉSIVE /
ANTIHAFT TABLETT GN

ALUMINIO /
ALUMINIUM

P. 52



CON FONDO DIFUSOR / WITH SANDWICH BOTTOM /
AVEC FOND THERMO-DIFFUSEUR / MIT SANDWICHBODEN

PATENTED EXCLUSIVE

 **INDUCTION**



..... ESPAÑOL
CUBETAS GN CON FONDO DIFUSOR: ÚNICAS,
ADAPTADAS A LA COCCIÓN EN PLACAS DE INDUCCIÓN
MEDIANTE FONDO SANDWICH (INOX-ALU-INOX).

..... ENGLISH
GN CONTAINERS WITH SANDWICH BASE, SUITABLE
FOR COOKING DIRECTLY ON ANY KIND OF STOVES
INCLUDING INDUCTION.

..... FRANÇAIS
BACS GN AVEC FOND THERMO-DIFFUSEUR APTE
SUR TOUT TYPE DE CUISINIÈRES, SURTOUT
EN INDUCTION.

..... DEUTSCH
GN BEHÄLTER MIT SANDWICHBODEN: EINZIGARTIG,
GEEIGNET FÜR DAS KOCHEN AUF INDUKTIONSKOCHFELDERN
MITTELS SANDWICHBODEN.

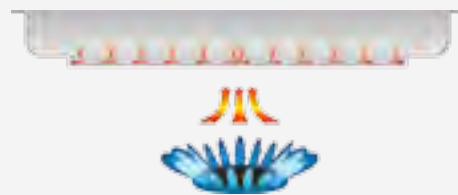

**Cubeta GN con fondo difusor / Sandwich bottom Gn container /
Bac GN avec fond thermo-diffuseur / GN Behälter mit Sandwichboden**



PATENTED EXCLUSIVE



INOX - ST/STEEL
EDELSTAHL
18/10



REF	TIPO / TYPE	H mm	Lts	€	U
110.4F1	1/1	40	5,10	61,70	1
110.6F1	1/1	65	8,30	69,80	1
111.0F1	1/1	100	14,20	100,30	1
111.5F1	1/1	150	20,20	137,30	1
120.4F1	1/2	40	2,20	49,15	1
120.6F1	1/2	65	4,10	54,70	1
121.0F1	1/2	100	6,10	69,30	1
121.5F1	1/2	150	9,10	83,90	1

**Cubeta GN con fondo difusor y asas / Sandwich bottom Gn container with handles /
Bac GN avec fond thermo-diffuseur et anses / GN Behälter mit Sandwichboden und Griffen**



PATENTED EXCLUSIVE



INOX - ST/STEEL
EDELSTAHL
18/10



REF	TIPO / TYPE	H mm	Lts	€	U
111.0F2	1/1	100	14,20	109,85	1
111.5F2	1/1	150	20,20	150,25	1
121.0F2	1/2	100	6,10	76,00	1
121.5F2	1/2	150	9,10	91,90	1

TRANSPORTE Y ALMACENAMIENTO /
TRANSPORT & STORAGE /
TRANSPORT ET STOCKAGE

GASTRONORM POLICARBONATO / POLYCARBONATE GASTRONORM /
GASTRONORME POLYCARBONATE / GASTRONORM POLYCARBONAT



- 40 °C
 + 130 °C

ESPAÑOL

UTILIZACIÓN: ALMACENAMIENTO DE PRODUCTOS A GRANDEL, INGREDIENTES VARIOS EN NEVERAS O CÁMARAS FRIGORÍFICAS.
IDEALES PARA PRESENTACIÓN EN BUFFETS FRÍOS.

ENGLISH

USE TO STORE BULK PRODUCTS AND INGREDIENTS IN COOLERS, FREEZERS OR PANTRY.
HIGHLY RECOMMENDED FOR TRANSPORTATION AND MICROWAVES COOKING.

FRANÇAIS

UTILISATION : STOCKAGE DE PRODUITS ET INGRÉDIENTS EN VRAC DANS LES UNITÉS RÉFRIGÉRÉES OU PLACARDS.
IDÉAL POUR LE TRANSPORT ET LA CUISSON EN FOUR MICRO-ONDES.

DEUTSCH

GEBRAUCH: LAGERUNG VON UNVERPACKTEN LEBENSMITTEL, VERSCHIEDENEN ZUTATEN IN KÜHLSCHRÄNKEN ODER KÜHLKAMMERN.
IDEAL FÜR DIE PRÄSENTATION DES KALTEN BUFFETS.

1/1 530 x 325 mm



REF	H mm	Lts	€	U
1106C1	65	8,70	13,55	12
1110C1	100	13,30	19,95	12
1115C1	150	19,60	24,20	12
1120C1	200	25,50	28,85	6

1/2 325 x 265 mm

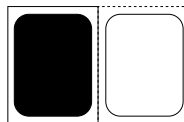

REF	H mm	Lts	€	U
1206C1	65	4,00	9,20	30
1210C1	100	6,00	11,40	24
1215C1	150	8,70	14,70	24
1220C1	200	11,20	18,75	18

1/3 325 x 175 mm

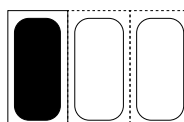

REF	H mm	Lts	€	U
1306C1	65	2,35	6,45	18
1310C1	100	3,50	8,90	12
1315C1	150	5,00	10,50	12
1320C1	200	6,35	13,35	6

GASTRONORM POLICARBONATO / POLYCARBONATE GASTRONORM / GASTRONORME POLYCARBONATE / GASTRONORM POLYCARBONAT

1/4 265 x 162 mm

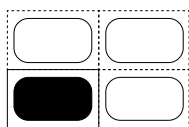

REF	H mm	Lts	€	U
1406C1	65	1,65	6,45	18
1410C1	100	2,46	7,55	18
1415C1	150	3,47	8,70	12

1/6 176 x 162 mm

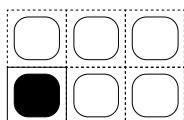

REF	H mm	Lts	€	U
1606C1	65	0,95	4,65	30
1610C1	100	1,40	5,25	24
1615C1	150	1,95	7,05	24

1/9 176 x 108 mm

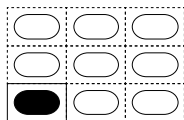

REF	H mm	Lts	€	U
1906C1	65	0,54	4,75	30
1910C1	100	0,77	5,70	30

Tapa policarbonato / Polycarbonate lid / Couvercle Polycarbonate / Polycarbonat Deckel



REF	Mod	€	U
1100C1	1/1	14,20	30
1200C1	1/2	7,35	60
1300C1	1/3	5,70	30
1400C1	1/4	4,45	30
1600C1	1/6	3,95	60
1900C1	1/9	3,55	30

Fondo perforado / Perforated bottom / Fond perforé / Gelochter Boden



REF	Mod	€	U
1150C1	1/1	11,40	36
1250C1	1/2	4,95	24
1350C1	1/3	4,55	24
1450C1	1/4	3,95	30
1650C1	1/6	2,20	30

Tapa Polinorm® / Polinorm® Lid / Couvercle Polinorm® / Polinorm® Deckel

PATENTED EXCLUSIVE



REF	Mod	€	U
1100 + COLOR	1/1	9,30	30
1200 + COLOR	1/2	5,60	60
1300 + COLOR	1/3	4,85	30
1400 + COLOR	1/4	3,95	30
1600 + COLOR	1/6	3,50	60
1900 + COLOR	1/9	3,10	30

Adaptable a / Adjustable to / Adaptable à / Einsetzbar:

Cubetas GN inox, PC, sin Bisfenol-A y PP /
St/Steel, PC, without Bisphenol-A and PP GN containers /
Bacs GN inox, PC, sans Bisphénol-A et PP /
GN Behälter rostfrei, PC, ohne Bisfenol-A und PP

Ref. color tapa /
Ref. colour lid /
Ref. couleur couvercle /
Art.Nr. Deckelfarbe



CUBETAS GASTRONORM SIN BISFENOL-A / GASTRONORM CONTAINERS, BISPHENOL-A FREE / BACS GASTRONORME SANS BISPHÉNOL-A / GASTRONORM BEHÄLTER OHNE BISFENOL-A



- 40 °C

+ 90 °C

ESPAÑOL

CUBETAS EN COPOLIESTER SIN BISFENOL-A (100% BPA FREE). ES UN MATERIAL ALTERNATIVO AL POLICARBONATO. CONFORMES CON LA NORMA EUROPEA EN 631.1 (COMPATIBLE CON LOS EQUIPOS Y APARATOS GASTRONORM). EXCELENTE TRANSPARENCIA Y RESISTENCIA A LOS IMPACTOS. IDEALES PARA ALMACENAR PRODUCTOS EN CÁMARAS FRIGORÍFICAS, DE PREPARACIÓN. CUBETAS APILABLES /

ENGLISH

CONTAINERS MADE OF COPOLYESTER WITHOUT BISPHENOL-A (100% BPA FREE). AN ALTERNATIVE MATERIAL TO POLYCARBONATE. COMPLIES WITH EUROPEAN STANDARD EN 631.1 (COMPATIBLE WITH GASTRONORM SYSTEMS AND APPLIANCES) EXCELLENT TRANSPARENCY AND IMPACT RESISTANCE. IDEAL FOR STORING PRODUCTS IN COLD ROOMS, FOR PREPARATION. STACKABLE CONTAINERS /

FRANÇAIS

BACS EN COPOLIESTER SANS BISPHÉNOL-A (100% BPA FREE). IL S'AGIT D'UN MATÉRIAU ALTERNATIF AU POLYCARBONATE. CONFORMES À LA NORME EUROPÉENNE EN 631.1 (COMPATIBLE AVEC LES MACHINES ET APPARELLS GASTRONORM). EXCELLENTE TRANSPARENCE ET RÉSISTANCE AUX CHOC. IDÉALES POUR EMMAGASINER DES PRODUITS DANS DES CHAMBRES FROIDES, DE PRÉPARATION. CUVETTES EMPILABLES.

DEUTSCH

BEHÄLTER AUS COPOLYESTER OHNE BISFENOL-A (100% BPA FREE). ES IST EIN ALTERNATIVES MATERIAL ZU POLYCARBONAT. ENTSPRECHEND DER EUROPÄISCHEN NORM 631.1 (KOMPATIBEL MIT ALLEN SYSTEMEN UND MASCHINEN GASTRONORM). EXZELLENTER TRANSPARENZ UND RESISTENZ GEGEN STÖSSE. IDEAL ZUM LAGERN VON PRODUKTEN IN KÜHLKAMMERN, ZUR VORBEREITUNG. BEHÄLTER STAPELBAR.

1/1

530 x 325 mm



REF	H mm	Lts	€	U
1106BF	65	8,70	17,30	12
1110BF	100	13,30	25,45	12
1115BF	150	19,60	30,95	12

1/2

325 x 265 mm

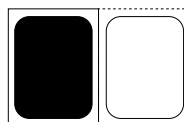

REF	H mm	Lts	€	U
1206BF	65	4,00	11,35	30
1210BF	100	6,00	14,00	24
1215BF	150	8,70	18,00	24

1/3

325 x 175 mm

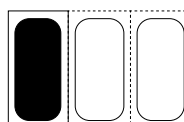

REF	H mm	Lts	€	U
1306BF	65	2,35	8,25	18
1310BF	100	3,50	11,40	12
1315BF	150	5,00	13,40	12

CUBETAS GASTRONORM SIN BISFENOL-A / GASTRONORM CONTAINERS, BISPHEENOL-A FREE / BACS GASTRONORME SANS BISPHÉENOL-A / GASTRONORM BEHÄLTER OHNE BISFENOL-A

1/4 265 x 162 mm

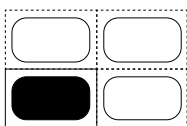

REF	H mm	Lts	€	U
1406BF	65	1,65	8,25	18
1410BF	100	2,46	9,65	18
1415BF	150	3,47	11,15	12

1/6 176 x 162 mm

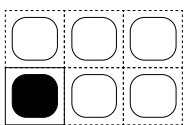

REF	H mm	Lts	€	U
1606BF	65	0,95	6,00	30
1610BF	100	1,40	6,75	24
1615BF	150	1,95	9,00	24

1/9 176 x 108 mm

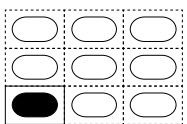

REF	H mm	Lts	€	U
1906BF	65	0,54	6,10	30
1910BF	100	0,77	7,30	30

Tapa gastronorm / Gastronorm lid / Couvercle gastronorme / Gastronorm Deckel



REF	Mod	€	U
1100BF	1/1	18,70	30
1200BF	1/2	9,70	60
1300BF	1/3	7,50	30
1400BF	1/4	5,90	30
1600BF	1/6	5,20	60
1900BF	1/9	4,65	30

Fondo perforado / Perforated bottom / Fond perforé / Gelochter Boden



REF	Mod	€	U
1150BF	1/1	15,00	36
1250BF	1/2	6,55	24
1350BF	1/3	6,05	24
1450BF	1/4	5,20	30
1650BF	1/6	2,90	30

Tapa Polinorm® / Polinorm® Lid / Couvercle Polinorm® / Polinorm® Deckel

PATENTED EXCLUSIVE



REF	Mod	€	U
1100 + COLOR	1/1	9,30	30
1200 + COLOR	1/2	5,60	60
1300 + COLOR	1/3	4,85	30
1400 + COLOR	1/4	3,95	30
1600 + COLOR	1/6	3,50	60
1900 + COLOR	1/9	3,10	30

Adaptable a / Adjustable to / Adaptable à / Einsetzbar:



Cubetas GN inox, PC, sin Bisfenol-A y PP /
St/Steel, PC, without Bisphenol-A and PP GN containers /
Bacs GN inox, PC, sans Bisphénol-A et PP /
GN Behälter rostfrei, PC, ohne Bisfenol-A und PP

Ref. color tapa /
Ref. colour lid /
Ref. couleur couvercle /
Art.Nr. Deckelfarbe



GASTRONORM POLIPROPILENO / POLYPROPYLENE GASTRONORM / GASTRONORME POLYPROPYLÈNE / POLYPROPYLEN GASTRONORM

PATENTED **EXCLUSIVE**

 - 40 °C
 + 110 °C

ESPAÑOL

UTILIZACIÓN: ALMACENAMIENTO DE PRODUCTOS A GRANTEL, INGREDIENTES VARIOS EN NEVERAS O CÁMARAS FRIGORÍFICAS.
IDEAL PARA TRANSPORTE Y COCCIÓN EN MICROONDAS.

ENGLISH

USE TO STORE BULK PRODUCTS AND INGREDIENTS IN COOLERS, FREEZERS OR PANTRY.
HIGHLY RECOMMENDED FOR TRANSPORTATION AND MICRO-WAVES COOKING.

FRANCAIS

UTILISATION : STOCKAGE DE PRODUITS ET INGRÉDIENTS EN VRAC DANS DES UNITÉS RÉFRIGÉRÉES OU PLACARDS.
IDÉAL POUR LE TRANSPORT ET LA CUISSON EN FOUR MICRO-ONDES.

DEUTSCH

GEBRAUCH: LAGERUNG VON UNVERPACKTEN LEBENSMITTEL, VERSCHIEDENEN ZUTATEN IN KÜHLSCHRÄNKEN ODER KÜHLKAMMERN.
IDEAL FÜR DEN TRANSPORT ODER ZUM KOCHEN IN MIKROWELLEN.

Tapa Polinorm® / Polinorm® Lid / Couvercle Polinorm® / Polinorm® Deckel

PATENTED **EXCLUSIVE**

REF	Mod	€	U
1100 + COLOR	1/1	9,30	30
1200 + COLOR	1/2	5,60	60
1300 + COLOR	1/3	4,85	30
1400 + COLOR	1/4	3,95	30
1600 + COLOR	1/6	3,50	60
1900 + COLOR	1/9	3,10	30

Adaptable a / Adjustable to / Adaptable à / Einsetzbar:

Cubetas GN inox, PC, sin Bisfenol-A y PP /
St/Steel, PC, without Bisphenol-A and PP GN containers /
Bacs GN inox, PC, sans Bisphénol-A et PP /
GN Behälter rostfrei, PC, ohne Bisfenol-A und PP

Ref. color tapa /
Ref. colour lid /
Ref. couleur couvercle /
Art.Nr. Deckelfarbe

**1/1** 530 x 325 mm

REF	H mm	Lts	€	U
1106P1	65	8,70	11,10	12
1110P1	100	13,30	11,40	12
1115P1	150	19,60	14,60	12
1120P1	200	25,50	18,45	6

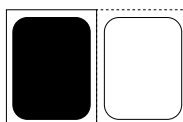
1/2 325 x 265 mm

REF	H mm	Lts	€	U
1206P1	65	4,00	6,65	30
1210P1	100	6,00	7,25	24
1215P1	150	8,70	8,80	24
1220P1	200	11,20	10,15	18

GASTRONORM POLIPROPILENO / POLYPROPYLENE GASTRONORM / GASTRONORME POLYPROPYLENE / POLYPROPYLEN GASTRONORM

1/3 325 x 175 mm

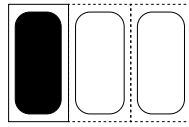

REF	H mm	Lts	€	U
1306P1	65	2,35	4,45	18
1310P1	100	3,50	5,05	12
1315P1	150	5,00	6,05	12
1320P1	200	6,35	7,55	6

1/4 265 x 162 mm

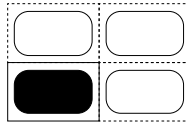

REF	H mm	Lts	€	U
1406P1	65	1,65	3,65	18
1410P1	100	2,46	3,95	18
1415P1	150	3,47	4,55	12

1/6 176 x 162 mm

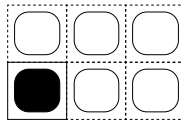

REF	H mm	Lts	€	U
1606P1	65	0,95	2,70	30
1610P1	100	1,40	3,05	24
1615P1	150	1,95	3,95	24

1/9 176 x 108 mm

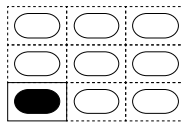

REF	H mm	Lts	€	U
1906P1	65	0,54	3,55	30
1910P1	100	0,77	3,95	30

Tapa policarbonato / Polycarbonate lid / couvercle Polycarbonate / Polycarbonat Deckel



REF	Mod	€	U
1100C1	1/1	14,20	30
1200C1	1/2	7,35	60
1300C1	1/3	5,70	30
1400C1	1/4	4,45	30
1600C1	1/6	3,95	60
1900C1	1/9	3,55	30

Fondo perforado / Perforated bottom / Fond perforé / Gelochter Boden



REF	Mod	€	U
1150P1	1/1	8,30	36
1250P1	1/2	3,85	24
1350P1	1/3	3,55	24
1450P1	1/4	3,05	30
1650P1	1/6	2,00	30





FLAP-RACK®

PATENTED EXCLUSIVE

SISTEMA DE MONTAJE Y DESMONTAJE FÁCIL, SEGURO Y SENCILLA PERSONALIZACIÓN /
 EASY ASSEMBLY AND DISASSEMBLY SYSTEM, SAFE AND SIMPLE CUSTOMIZATION /
 SYSTÈME DE MONTAGE ET DÉMONTAGE FACILE, SÛR ET DE SIMPLE PERSONNALISATION /
 EINFACHES MONTAGE- UND DEMONTAGESYSTEM, SICHERE UND EINFACHE PERSONALISIERUNG

APILABLES CON OTRAS CESTAS DEL MERCADO, REFUERZO DE DOBLE PARED (ANTI-GOLPES) /
 STACKABLE WITH OTHER MARKET RACKS REINFORCED DOUBLE-WALL (ANTI-SHOCK) /
 EMPILABLE AVEC D'AUTRES PANIERS DU MARCHÉ, RENFORCÉ AVEC DOUBLE PAROI (ANTI-CHOC) /
 STAPELBAR MIT ANDEREN KÖRBEIN AUF DEM MARKT, VERSTÄRKT MIT DOPPELWAND (ANTI-STOSS)

ABIERTA / OPENED / OUVERT / OFFEN

APERTURAS PARA MÁXIMA LIMPIEZA
 OPENINGS FOR MAXIMUM CLEANING
 OUVERTURES POUR UN NETTOYAGE PERFORMANT
 ÖFFNUNGEN FÜR MAXIMALE REINIGUNG

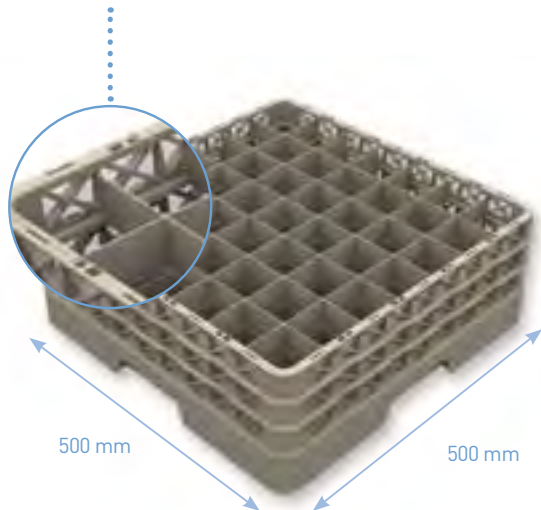

CERRADA / CLOSED / FERMÉ / GESCHLOSSEN

IDEALES PARA EL TRANSPORTE Y EL ALMACENAMIENTO
 IDEAL FOR TRANSPORTING AND STORING
 IDÉAL POUR LE TRANSPORT ET LE STOCKAGE
 IDEAL FÜR DEN TRANSPORT UND LAGERUNG

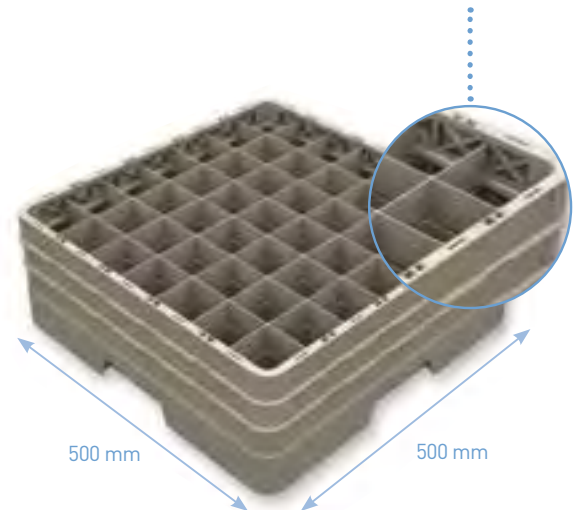

ESCOGER LO BUENO Y LO MEJOR A LA VEZ* /
 GET THE BEST OF BOTH WORLDS* /
 LE BON ET LE MEILLEUR À LA FOIS* /
 NEHMEN SIE DAS GUTE UND DAS BESTE AUF EINMAL*

FLAP-RACK®: fácil montaje / desmontaje
 FLAP-RACK®: easy to assembly / disassembly
 FLAP-RACK®: facile à monter / démonter
 FLAP-RACK®: Einfache Montage / Demontage

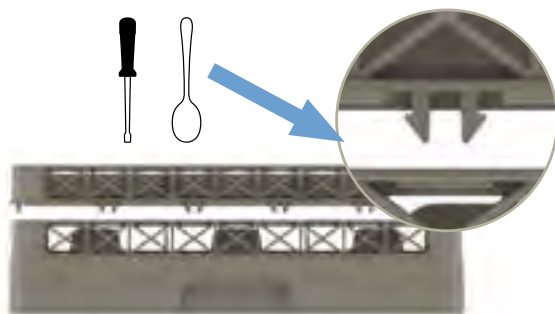

* Copolímero altamente resistente a sustancias químicas y temperaturas de hasta 95 °C.
 * Copolymer highly resistant to chemical products and temperatures up to 95 °C.
 * Copolymère très résistant aux produits chimiques et à températures jusqu'à 95 °C.
 * Copolymer höchster Widerstand gegen chemische Substanzen und Temperaturen bis zu 95 °C.

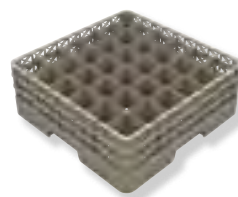

LAVADO: Mayor limpieza
 WASHING: Higher cleaning
 LAVAGE: MEILLEUR NETTOYAGE
 REINIGUNG: Bessere Reinigung



TRANSPORTE: Mayor seguridad
 TRANSPORT: Higher security
 TRANSPORT: Plus de sécurité
 TRANSPORT: Höhere Sicherheit

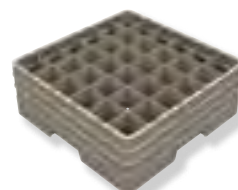

ALMACENAMIENTO: Mayor Higiene
 STORING: Higher hygiene
 STOCKAGE: Plus hygiénique
 LAGERUNG: Höhere Hygiene

SISTEMA PATENTADO QUE PERMITE CERRAR Y ABRIR LAS PAREDES DE LAS CESTAS Y EXTENSIONES FÁCILMENTE

SYSTEM PATENTED ALLOWS THE WALLS ON BOTH BASES AND EXTENDERS TO BE CLOSED OR OPEN EASILY

SYSTÈME BREVETÉ QUI PERMET D'OUVRIR OU DE FERMER FACILEMENT LES PAROIS DES CASIERS ET DES RÉHAUSSES

PATENTIERTES SYSTEM, WELCHES DAS EINFACHE ÖFFNEN UND SCHLIESSEN DER SPÜLKORBWÄNDE UND DIE VERGRÖßERUNG ERLAUBT.

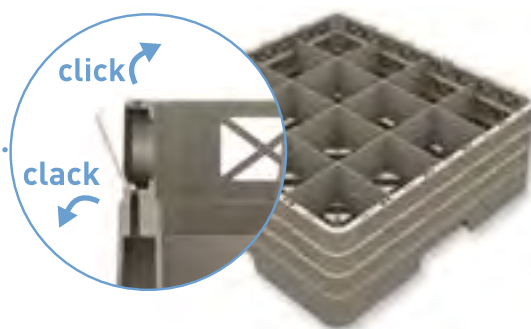

FLAP IDENTIFICADOR

Identificador de colores para cestas y extensiones completamente cerradas. Disponible en 6 colores. Posibilidad de marcar logo cliente. Ver pág. 146.

Colour identification for completely closed racks and extensions. Available in 6 colours. Possible personalisation. Refer to page 146.

Identificateur en couleurs pour casiers et réhaussees complètement fermés. Disponible en 6 couleurs. Personnalisation possible. Voir page 146.

Farbidentifikation für Spülkörbe und Vergrößerungen komplett geschlossen. Erhältlich in 6 Farben. Möglichkeit der Markierung mit dem Firmenlogo. Siehe Seite 146.



F1 marrón
brown
marron
braun



F4 amarillo
yellow
jaune
gelb

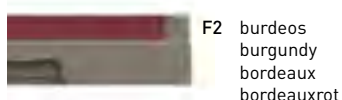

F2 burdeos
burgundy
bordeaux
bordeauxrot



F5 verde
green
vert
grün



F3 azul
blue
bleu
blau

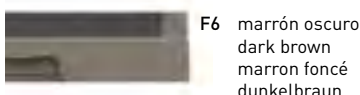

F6 marrón oscuro
dark brown
marron foncé
dunkelbraun



Logo o texto impreso / Printed logo or text /
Logo ou texte imprimé / Logo oder Text gedruckt



Logo o texto estampado / Hot stamped logo or text /
Logo ou texte gravé / Logo oder Text gestempelt

CLIP IDENTIFICADOR

Identificador de colores para cestas y extensiones abiertas. Disponible en 6 colores. Posibilidad de marcar logo cliente. Ver pág. 146.

Colour identification for open racks and extensions. Available in 6 colours. Possible personalisation. Refer to page 146.

Identificateur en couleurs pour casiers et réhaussees ouverts. Disponible en 6 couleurs. Personnalisation possible. Voir page 146.

Farbidentifikation für Spülkörbe und Vergrößerungen offen. Erhältlich in 6 Farben. Möglichkeit der Markierung mit dem Firmenlogo. Siehe Seite 146.



F1 marrón
brown
marron
braun

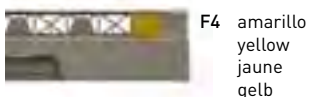

F4 amarillo
yellow
jaune
gelb

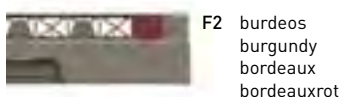

F2 burdeos
burgundy
bordeaux
bordeauxrot



F5 verde
green
vert
grün



F3 azul
blue
bleu
blau



F6 marrón oscuro
dark brown
marron foncé
dunkelbraun



Logo o texto impreso
Printed logo or text
Logo ou texte imprimé
Logo oder Text gedruckt



Logo o texto estampado
Hot stamped logo or text
Logo ou texte gravé
Logo oder Text gestempelt



ABIERTAS / OPENED / OUVERTS / OFFEN



Ø max. 151 mm

**5090**

BASE 9 COMPART.

**5091**

EXT. 9 COMPART.

REF	€	U
5090	19,55	6
5091	9,20	12



Ø max. 113 mm

**5160**

BASE 16 COMPART.

**5161**

EXT. 16 COMPART.

REF	€	U
5160	21,75	6
5161	9,30	12



Ø max. 89 mm

**5250**

BASE 25 COMPART.

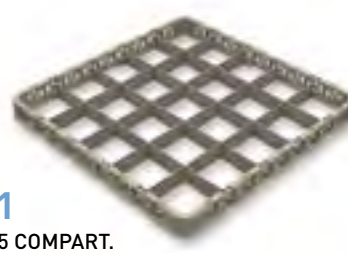
**5251**

EXT. 25 COMPART.

REF	€	U
5250	22,65	6
5251	9,85	12



Ø max. 73 mm

**5360**

BASE 36 COMPART.

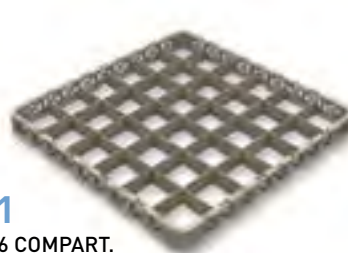
**5361**

EXT. 36 COMPART.

REF	€	U
5360	24,00	6
5361	10,15	12



Ø max. 63 mm

**5490**

BASE 49 COMPART.

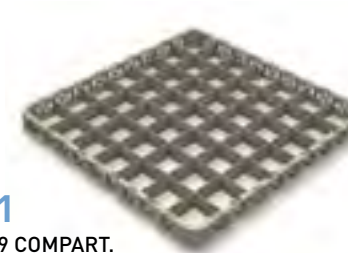
**5491**

EXT. 49 COMPART.

REF	€	U
5490	24,80	6
5491	10,50	12



 Ø max. 151 mm
9 COMPART.



REF	 max. (mm)	H (mm)*	€
5090 E1	120	140	30,10
5090 E2	160	180	39,70
5090 E3	200	220	49,35
5090 E4	240	260	58,95
5090 E5	280	300	68,50

 Ø max. 113 mm
16 COMPART.



REF	 max. (mm)	H (mm)*	€
5160 E1	120	140	32,45
5160 E2	160	180	42,20
5160 E3	200	220	51,90
5160 E4	240	260	61,65
5160 E5	280	300	71,30

 Ø max. 89 mm
25 COMPART.



REF	 max. (mm)	H (mm)*	€
5250 E1	120	140	34,05
5250 E2	160	180	44,25
5250 E3	200	220	54,50
5250 E4	240	260	64,85
5250 E5	280	300	75,15

 Ø max. 73 mm
36 COMPART.



REF	 max. (mm)	H (mm)*	€
5360 E1	120	140	34,75
5360 E2	160	180	44,75
5360 E3	200	220	54,90
5360 E4	240	260	64,95
5360 E5	280	300	75,85

 Ø max. 63 mm
49 COMPART.



REF	 max. (mm)	H (mm)*	€
5490 E1	120	140	36,10
5490 E2	160	180	46,85
5490 E3	200	220	57,60
5490 E4	240	260	68,30
5490 E5	280	300	80,55

* Altura total del conjunto
* Total set height
* Hauteur totale lot
* Gesamthöhe des Sets

CERRADAS / CLOSED / FERMÉS / GESCHLOSSEN



Ø max. 151 mm

**5090F1**

BASE 9 COMPART.

**5091F1**

EXT. 9 COMPART.

REF	€	U
5090 F1	21,20	6
5091 F1	10,80	12



Ø max. 113 mm

**5160F1**

BASE 16 COMPART.

**5161F1**

EXT. 16 COMPART.

REF	€	U
5160 F1	23,50	6
5161 F1	10,90	12

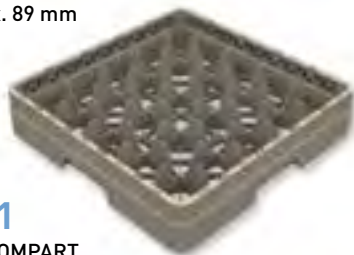

Ø max. 89 mm

**5250F1**

BASE 25 COMPART.

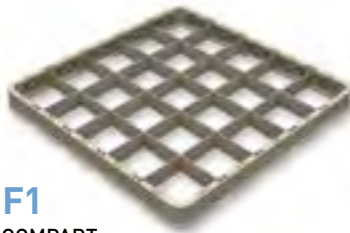
**5251F1**

EXT. 25 COMPART.

REF	€	U
5250 F1	24,30	6
5251 F1	11,40	12

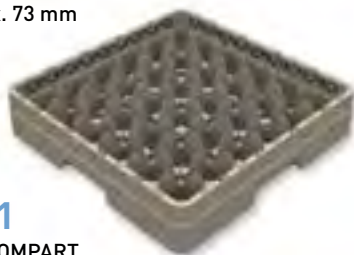

Ø max. 73 mm

**5360F1**

BASE 36 COMPART.

**5361F1**

EXT. 36 COMPART.

REF	€	U
5360 F1	25,20	6
5361 F1	11,00	12

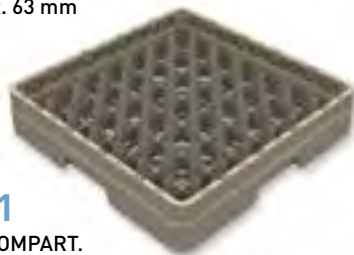

Ø max. 63 mm

**5490F1**

BASE 49 COMPART.

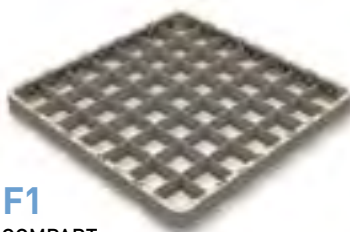
**5491F1**

EXT. 49 COMPART.

REF	€	U
5490 F1	26,10	6
5491 F1	11,60	12

Indicar el código de color al final de la referencia.
Indicate the colour code at the end of the item reference.
Indiquer le code de couleur a la fin de la référence.
Angabe des Farbcodes am Ende der Artikelnummer.



F1



F2



F3



F4



F5



F6

 Ø max. 151 mm
9 COMPART.



REF	 max. (mm)	H (mm)*	€
5090 E1F1	120	140	34,15
5090 E2F1	160	180	44,75
5090 E3F1	200	220	54,60
5090 E4F1	240	260	65,85
5090 E5F1	280	300	77,15

 Ø max. 113 mm
16 COMPART.



REF	 max. (mm)	H (mm)*	€
5160 E1F1	120	140	34,35
5160 E2F1	160	180	45,60
5160 E3F1	200	220	57,00
5160 E4F1	240	260	68,30
5160 E5F1	280	300	77,25

 Ø max. 89 mm
25 COMPART.



REF	 max. (mm)	H (mm)*	€
5250 E1F1	120	140	34,25
5250 E2F1	160	180	46,95
5250 E3F1	200	220	57,10
5250 E4F1	240	260	68,20
5250 E5F1	280	300	77,65

 Ø max. 73 mm
36 COMPART.



REF	 max. (mm)	H (mm)*	€
5360 E1F1	120	140	33,95
5360 E2F1	160	180	45,80
5360 E3F1	200	220	56,20
5360 E4F1	240	260	65,35
5360 E5F1	280	300	77,85

 Ø max. 63 mm
49 COMPART.



REF	 max. (mm)	H (mm)*	€
5490 E1F1	120	140	34,15
5490 E2F1	160	180	44,15
5490 E3F1	200	220	54,30
5490 E4F1	240	260	65,85
5490 E5F1	280	300	78,95

* Altura total del conjunto
* Total set height
* Hauteur totale lot
* Gesamthöhe des Sets

Indicar el código de color al final de la referencia.
Indicate the colour code at the end of the item reference.
Indiquer le code de couleur a la fin de la référence.
Angabe des Farbcodes am Ende der Artikelnummer.



F1



F2



F3



F4



F5



F6

5002 / 5001 Cesta universal / Open rack / Panier universel / Universalspülkorb



5002



5001

REF	€	U
5002	20,55	6
5001	7,15	12



Extensión abierta
Open extender
Rehausse sans compartiments
Offene Ausführung

5000 / 5003 Cesta para platos, bandejas y cubiertos / Plate, tray and cutlery baskets / Paniers pour plats, plateaux et couverts / Lagerbehälter und Körbe für Geschirr, Besteck und Tablett



5000

Cesta para cubiertos /
Flatware rack /
Panier a couverts /
Besteckspülkorb



5003

Cesta para platos y bandejas /
Plates and trays rack /
Panier pour assiettes et plateaux /
Spülkorb für Teller und Tablett



REF	€	U
5000	21,85	6
5003	21,85	6

5010 Tapa para cestas / Rack lid / Couvercle pour panier / Spülkorbdeckel



REF	€	U
5010	16,95	6



5060 Cesta para almacenar cubiertos / Basket for cutlery storage / Panier pour rangement couverts / Besteckkorb



REF	max. (mm)	H (mm)*	CAPACIDAD CUBIERTOS / CUTLERY STORAGE / CAPACITÉ COUVERTS / KORB FÜR BESTECKE	€	U
5060	15	18	400	77,10	1
5061	19	22	400	87,60	1
5062	23	26	400	97,90	1

*Altura total del conjunto
Total set height
Hauteur totale lot
Gesamthöhe des Sets

Media cesta para cubiertos / Flatware basket / Demi-panier pour couverts / Spülkorbeinsatz für Besteck

5018

Con asa
With handle
Avec anse
Mit griff

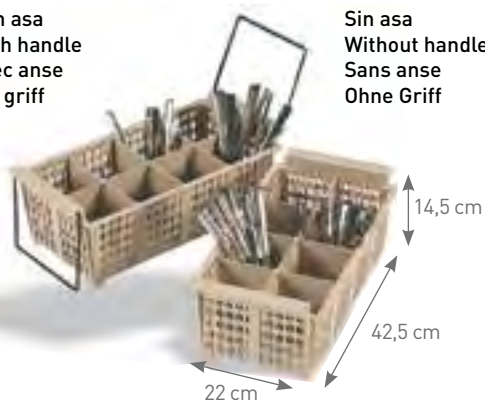

5019

Sin asa
Without handle
Sans anse
Ohne Griff

5004

Cestillo para cubiertos
Flatware basket
Petit panier pour couverts
Kleiner Spülkorbeinsatz
für Besteck

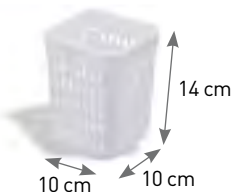

REF	€	U
5018	20,55	6
5019	13,05	6
5004	2,20	6

ESPAÑOL

CESTAS ESPECIALES PARA PLATOS: IDEALES PARA EL LAVADO, ALMACENAMIENTO Y TRANSPORTE DE PLATOS. PERFECTAS PARA BANQUETES, HOTELES, COLECTIVIDADES Y EMPRESAS DE ALQUILER DE MATERIAL PARA LA HOSTELERÍA. REDUCEN LAS ROTURAS DE PLATOS, MINIMIZAN EL COSTE DEL TRANSPORTE Y MANIPULACIÓN.

ENGLISH

PLATE CRATE: PERFECT DISH WASHING, STORING AND TRANSPORTING FOR BANQUETS, HOTELS, INSTITUTIONS AND CATERING EQUIPMENT RENTAL COMPANIES. THEY MINIMIZE THE PLATE BREAKAGE, LABOUR AND HANDLING COST

FRANÇAIS

CASIERS POUR ASSIETTES: IDÉALES POUR LE LAVAGE, STOCKAGE ET TRANSPORT D'ASSIETTES. PARFAITS POUR BANQUETS, HÔTELS, COLLECTIVITÉS ET SOCIÉTÉS DE LOCATION DE MATÉRIEL POUR L'HÔTELLERIE. CE TYPE DE CASIERS PERMET DE RÉDUIRE LE NOMBRE D'ASSIETTES CASSÉES AINSI QU'UNE DIMINUTION DES COÛTS DE TRANSPORT ET MANIPULATION

DEUTSCH

SPÜLKÖRBE SPEZIELL FÜR TELLER: IDEAL FÜR DIE REINIGUNG, LAGERUNG UND TRANSPORT DER TELLER. PERFEKT FÜR BANKETTS, HOTELS, CATERING UND FIRMEN, DIE GASTRONOMIEMATERIAL VERMIETEN. WENIGER ZERBROCHENE TELLER, MINIMIERUNG DER TRANSPORT- UND ABWICKLUNGSKOSTEN.

Dos modalidades /
Two types /
Deux modèles /
Zwei Typen

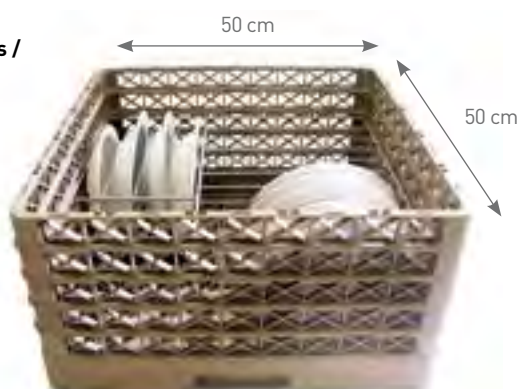

Limpieza y secado rápido.
Faster wash and rinse.
Proprété et séchage plus rapide.
Schnelle Reinigung und Trocknung.



Almacenamiento y transporte más seguro e higiénico.
More safety and hygienic storing and transporting.
Stockage et transport plus sûr et hygiénique.
Lagerung und Transport sicherer und hygienischer.

Nueve formatos de rejilla /
Nine different grids /
Neuf grilles différentes /
Neun Gitterformate

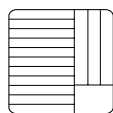

1412-6

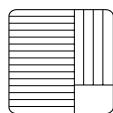

1912-6

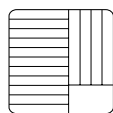

1510-5

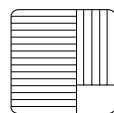

2011-5

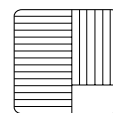

2110-5

Mayor protección, resistencia y durabilidad.
Extra protection, strength and durability.
Plus grande protection, résistance et durabilité.
Extra Schutz, Resistenz und Langlebigkeit.

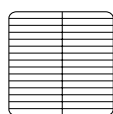

3008-4

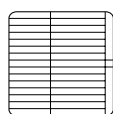

3208-3

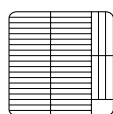

4407-3

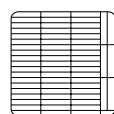

6305-2

Como elegir la cesta de platos adecuada:
debe medir el diámetro y altura del plato. Con estos datos escoger, de las 9 combinaciones posibles, aquella que se ajuste más a las medidas del plato.

How to chose the appropriate plate crate:
measure the plate diameter and height. You have then to chose between the 9 different grids according to the measures you get previously.

Comment choisir le casier pour assiettes:
Mesurer le diamètre et l'hauteur de l'assiette. Selon ces mesures choisir entre le 9 possibles combinaisons de grille qui s'adapte au mieux.

Wie wählen Sie den geeigneten Tellerspülkorb:
Messen Sie den Diameter und die Höhe des Tellers. Mit diesen Massen wählen Sie eine von 9 verschiedenen Kombinationen aus, die sich am nächsten an die Masse der Teller anpasst.





CESTAS PARA PLATOS / PLATE RACKS / CASIERS ASSIETTES / TELLERSPÜLKÖRBE

1412-6

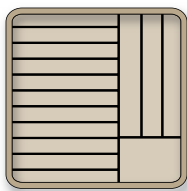

Ø 27-31 cm





REF	 max. (cm)	CAPACIDAD PLATOS CAPACITY PLATES CAPACITÉ ASSIETTES TELLERFASSUNGSVERMÖGEN	€	U
1412-6	3,5	14	137,65	1
1412-6 F1*	3,5	14	166,10	1

1510-5

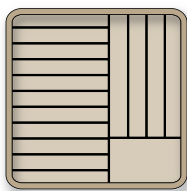

Ø 23-28 cm





REF	 max. (cm)	CAPACIDAD PLATOS CAPACITY PLATES CAPACITÉ ASSIETTES TELLERFASSUNGSVERMÖGEN	€	U
1510-5	3,5	15	129,90	1
1510-5 F1*	3,5	15	152,85	1

1912-6

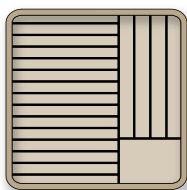

Ø 28-30,5 cm





REF	 max. (cm)	CAPACIDAD PLATOS CAPACITY PLATES CAPACITÉ ASSIETTES TELLERFASSUNGSVERMÖGEN	€	U
1912-6	2,5	19	138,00	1
1912-6 F1*	2,5	19	171,65	1

2011-5

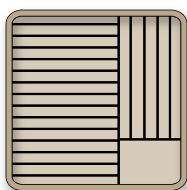

Ø 25-28 cm





REF	 max. (cm)	CAPACIDAD PLATOS CAPACITY PLATES CAPACITÉ ASSIETTES TELLERFASSUNGSVERMÖGEN	€	U
2011-5	2,5	20	130,65	1
2011-5 F1*	2,5	20	155,15	1

2110-5

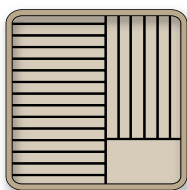

Ø 23-25 cm





REF	 max. (cm)	CAPACIDAD PLATOS CAPACITY PLATES CAPACITÉ ASSIETTES TELLERFASSUNGSVERMÖGEN	€	U
2110-5	2,5	21	107,50	1
2110-5 F1*	2,5	21	119,40	1

3008-4

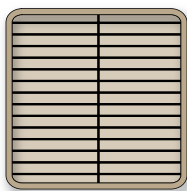

Ø 20-22 cm



REF	 max. (cm)	CAPACIDAD PLATOS CAPACITY PLATES CAPACITÉ ASSIETTES TELLERFASSUNGSVERMÖGEN	€	U
3008-4	2,5	30	101,50	1
3008-4 F1*	2,5	30	114,00	1

- * Cestas cerradas
- * Closed racks
- * Paniers fermés
- * Geschlossene Spülkörbe

Indicar el código de color al final de la referencia.
Indicate the colour code at the end of the item reference.
Indiquer le code de couleur a la fin de la référence.
Angabe des Farbcodes am Ende der Artikelnummer.



F1



F2



F3



F4





F5

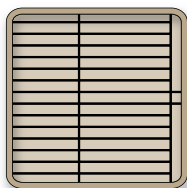
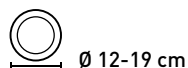

F6

3208-3



REF	 I max. (cm)	CAPACIDAD PLATOS CAPACITY PLATES CAPACITÉ ASSIETTES TELLERFASSUNGSVERMÖGEN	€	U
3208-3	2,5	32	102,00	1
3208-3 F1*	2,5	32	117,00	1

4407-3

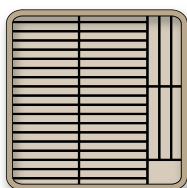
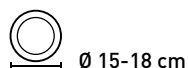

REF	 I max. (cm)	CAPACIDAD PLATOS CAPACITY PLATES CAPACITÉ ASSIETTES TELLERFASSUNGSVERMÖGEN	€	U
4407-3	2	44	103,25	1
4407-3 F1*	2	44	116,70	1

6305-2

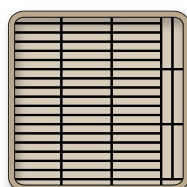
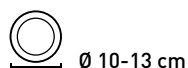

REF	 I max. (cm)	CAPACIDAD PLATOS CAPACITY PLATES CAPACITÉ ASSIETTES TELLERFASSUNGSVERMÖGEN	€	U
6305-2	2,5	63	102,85	1
6305-2 F1*	2,5	63	117,00	1

5050 Cesta para bandejas isotérmicas y GN / GN and isothermal tray rack / Panier pour plateaux isothermes et GN / Spülkorb für isothermische Tablets und GN



REF	DISTANCIA ENTRE COMPART. (mm) DISTANCE BETWEEN COMPART. (mm) DISTANCE ENTRE COMPART. (mm) FÄCHERABSTAND. (mm)	€	U
5050	75	85,20	1

5 Compartimentos
5 Compartments
5 Compartiments
5 Fächer

5030 Cesta para grandes bandejas / Open tray rack / Panier pour grands plateaux / Spülkorb für grosse Tablets



REF	€	U
5030	27,50	12



- * Cestas cerradas
- * Closed racks
- * Paniers fermés
- * Geschlossene Spülkörbe

Indicar el código de color al final de la referencia.
Indicate the colour code at the end of the item reference.
Indiquer le code de couleur a la fin de la référence.
Angabe des Farbcodes am Ende der Artikelnummer.

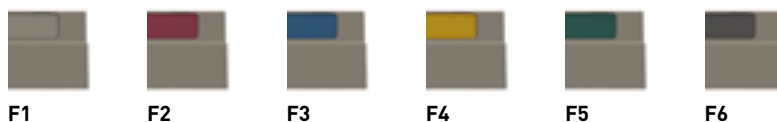

FLAP

501F Flap

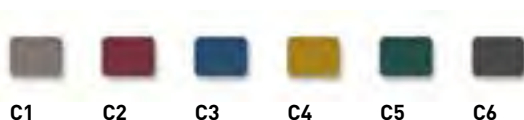

REF	COLOR / COLOUR / COULEUR / FARBE	€	U
501F1	Marrón / Brown / Marron / Braun	1,05	24
501F2	Burdeos / Burgundy / Bordeaux / Bordeauxrot	1,05	24
501F3	Azul / Blue / Bleu / Blau	1,05	24
501F4	Amarillo / Yellow / Jaune / Gelb	1,05	24
501F5	Verde / Green / Vert / Grün	1,05	24
501F6	Marrón oscuro / Dark brown / Marrón foncé / Dunkelbraun	1,05	24

500C Clip identificación / Clip tags /
Clip d'identification / Klippidentifizierung

REF	COLOR / COLOUR / COULEUR / FARBE	€	U
500C1	Marrón / Brown / Marron / Braun	0,75	24
500C2	Burdeos / Burgundy / Bordeaux / Bordeauxrot	0,75	24
500C3	Azul / Blue / Bleu / Blau	0,75	24
500C4	Amarillo / Yellow / Jaune / Gelb	0,75	24
500C5	Verde / Green / Vert / Grün	0,75	24
500C6	Marrón oscuro / Dark brown / Marrón foncé / Dunkel-braun	0,75	24

Flap Logo - Clip Logo Personalización / Personalisation / Personnalisation / Personalisierung

PERSONALIZACIÓN SEGÚN DISEÑO DEL CLIENTE. CÓMO HACER EL PEDIDO:

1.- Enviar diseño definitivo en formato digital (.jpeg, .tiff, .eps) a flaprack@pujadas.es indicando referencia Flap/Clip y cantidad a marcar.
Mínimo 200 unidades para impresión y 1.000 unidades para estampado.

2.- Pujadas confeccionará una muestra y presupuesto (según diseño y cantidad indicada) que se enviará al cliente para su aprobación.
Coste útiles de impresión y envío muestras: 120 € (impresión); para estampado, consultar.

PERSONALISATION ACCORDING TO CUSTOMER'S DESIGN. HOW TO ORDER:

1.- The final artwork has to be sent in digital format (.jpeg, .tiff, .eps) to flaprack@pujadas.es indicating Flap/Clip reference and quantity.
Minimum order 200 units for printing and 1.000 for stamping.

2.- Pujadas is going to make a sample and quotation (according to customer's design and quantity) which will be sent to the customer for final approval.
Tooling and printing cost for samples: 120 € (printing); for stamping, please consult.

PERSONALISATION SELON LES BESOINS DES CLIENTS. COMMENT FAIRE LA COMMANDE:

1.- Envoyer le dessin définitif en format digital (.jpeg, .tiff, .eps) a flaprack@pujadas.es indiquant la référence du Flap/Cip et la quantité.
Commande minimale 200 unités pour impression et 1.000 unités pour la gravure.

2.- Pujadas réalisera un échantillon et devis (suivant le design et quantité indiquée) qui s'enverra au client pour confirmation.
Coût des outils et d'envoi de l'échantillon: 120 € (impression); veuillez consulter pour la gravure.

PERSONALISIERUNG ENTSPRECHEND DEM DESIGN DES KUNDEN. WIE BESTELLEN SIE:

1.- Senden Sie die endgültige Version des Designs im digitalen Format (.jpeg, .tiff, .eps) an flaprack@pujadas.es mit dem Betreff "Flap/Clip" und mit der Angabe der zu markierenden Menge. Mindestbestellung 200 Stück für die Bedruckung und 1.000 für die Stempelung.

2.- Pujadas stellt ein Muster her und erstellt einen Kostenvoranschlag (entsprechend Kundendesign und Menge) und schickt diese zur Bestätigung an den Kunden. Herstellungskosten des Drucks und Versendung des Musters: 120 € (Druck); für Stempelung, bitte nachfragen.

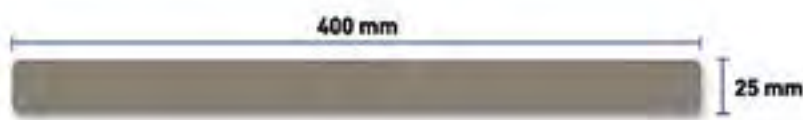

Superficie de impresión.
Printing area.
Surface d'impression.
Druckfläche.

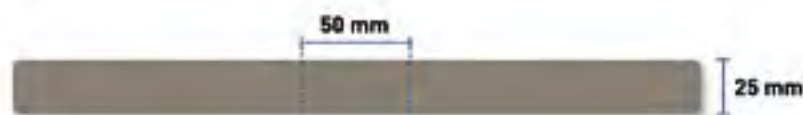

Superficie de estampación.
Hot stamping area.
Surface de gravure.
Stempelfläche.

GUÍA DE SELECCIÓN PARA BASES Y EXTENSIONES /
 REFERENCE GUIDE FOR BASES AND EXTENSIONS /
 GUIDE DE SELECTION POUR BASES ET EXTENTIONS /
 AUSWAHLÜBERSICHT FÜR DIE BASIS UND VERGRÖSSERUNGEN

DIÁMETRO

Coloque el vaso o la copa (boca abajo) sobre el diagrama de círculos. El círculo que se ajuste al diámetro máximo de la copa (base, cuerpo o parte superior) le determinará el número de compartimentos necesarios.

DIAMETER

Place glass upside down over the circle chart. Whatever circle the largest diameter of the glass (base, body or upper part) fits within will determine the number of compartments.

DIAMÈTRE

Placer le verre à l'envers au-dessus du diagramme des cercles. Le cercle qui s'ajuste au mieux au plus grand diamètre du verre (base, corps ou partie supérieure) déterminera le nombre de compartiments nécessaires.

DIAMETER

Stellen Sie das Gefäß mit dem Kopf nach unten auf die Kreisabbildung. Der Kreis, der sich am Nächsten an den Maximaldiameter des Gefäßes (Basis, Körper oder Oberteil) nähert, bestimmt die Anzahl der benötigten Fächer.

ALTURA

Utilice la guía vertical para determinar el número apropiado de extensiones que precisa. En el caso de que la altura del vaso o copa esté entre dos extensiones, siempre escoger la inmediatamente superior.

HEIGH

Use the vertical guide to determine the height and the appropriate number of extenders. If the height of glass is between two extensions, please choose always the immediately superior one.

HAUTEUR

Utiliser le guide vertical pour déterminer la hauteur et le nombre de rehausses nécessaires. Dans le cas où la hauteur du verre soit entre deux rehausses, veuillez impérativement choisir la rehausse supérieure.

HÖHE

Benutzen Sie die seitliche Skala um die passende Anzahl der Vergrößerungen zu bestimmen. Wenn die Gefäßhöhe zwischen zwei Vergrößerungen ist, ist die nächsthöhere zu wählen.

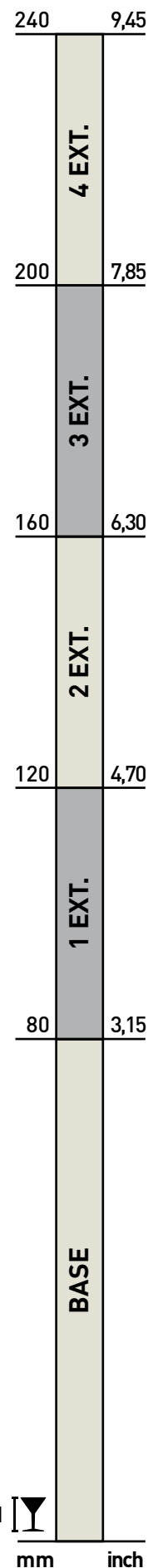
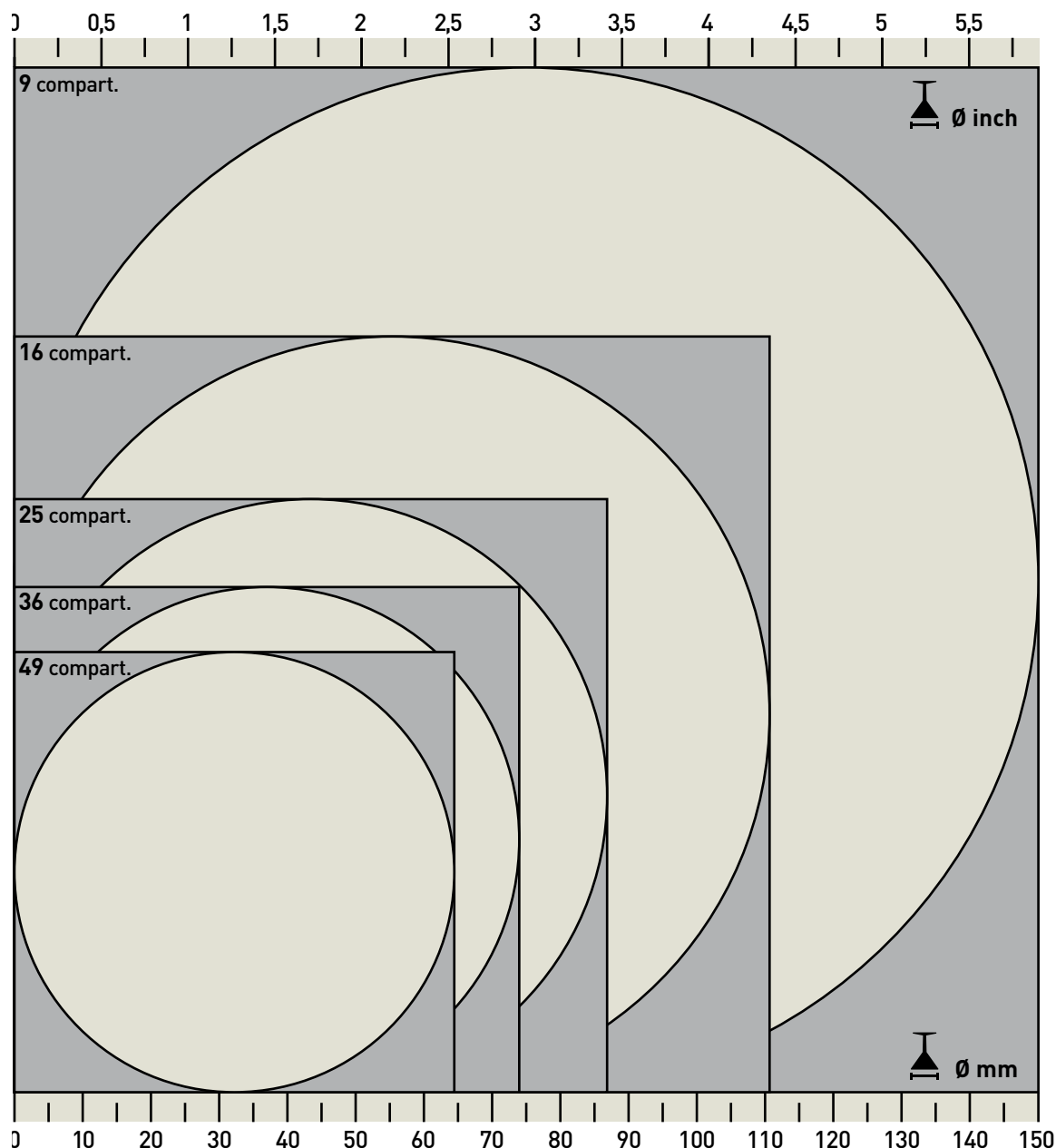

TRANSPORTE Y ALMACENAMIENTO /
 TRANSPORT & STORAGE /
 TRANSPORT ET STOCKAGE

CARROS DE SERVICIO EN MADERA / WOODEN SERVING TROLLEYS / CHARIOTS DE SERVICE EN BOIS / SERVIERWAGEN AUS HOLZ

CUBIC® BY PUJADAS

COLD

CARRO BUFFET CON POSIBILIDAD DE CONVERTIR EL CARRO EXPOSITOR EN MESA DE PRESENTACIÓN /
BUFFET TROLLEY WITH POSSIBLE TRANSFORMATION FROM AN EXPOSITOR TROLLEY TO A PRESENTATION TABLE /
CHARIOT BUFFET AVEC POSSIBILITÉ DE CONVERTIR LE CHARIOT D'EXPOSITION EN UNE TABLE DE PRÉSENTATION /
BUFFETSERVIERWAGEN MIT DER MÖGLICHKEIT DIESEN IN EINEN PRÄSENTATIONSTISCH UMZUWANDELN

90490 Carro buffet negro 4 GN 1/1 / Black buffet trolley for 4 1/1 GN inserts /
Chariot buffet noir pour 4 bacs GN 1/1 / Schwarzer Buffetservierwagen 4 GN 1/1

MADERA CON TRATAMIENTO HIDRÓFUGO ESPECIAL, DE FÁCIL LIMPIEZA /

WOOD WITH SPECIAL WATERPROOF TREATMENT, EASY TO CLEAN /

BOIS AVEC UN TRAITEMENT HYDROFUGE SPÉCIAL, FACILE À NETTOYER /

HOLZ MIT SPEZIELLER WASSERABWEISENDER BEHANDLUNG, EINFACH ZU REINIGEN

ADAPTADO A MEDIDAS GASTRONORM /

SUITABLE FOR GASTRONORM SIZES /

ADAPTÉ AUX MESURES GASTRONORME /

GEEIGNET FÜR GASTRONORMGRÖSSEN

EXCLUSIVE



*Dos tapas incluidas en precio /
*Two covers are included on the price /
*Deux tablettes comprises dans le prix /
*Zwei Deckel im Preis inklusive

REF. 90492

900 mm

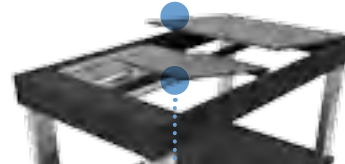

Tapa individual encaje GN 1/1 no incluida en precio /
Cover for 1/1 GN insert not included on the price /
Tablette de bac GN 1/1 non comprise dans le prix /
Individueller Deckel passend zu GN 1/1 nicht im Preis inklusive

REF. 90493

ELEGANTE COMBINACIÓN DE MADERA Y ALUMINIO /

OUTSTANDING COMBINATION OF WOOD AND ALUMINIUM /

COMBINAISON ÉLÉGANTE EN BOIS ET EN ALUMINIUM /

ELEGANTE KOMBINATION AUS HOLZ UND ALUMINIUM

RUEDAS GIRATORIAS E INSONORAS DE Ø 125 mm, CON FRENO /

SOUNDPROOF AND REVOLVING CASTORS Ø 125 mm, WITH BRAKES /

ROULETTES INSONORES ET PIVOTANTES DE Ø 125 mm, AVEC FREINS /

BEWEGLICHE UND GERÄUSCHLOSE RÄDER Ø 125 mm, MIT BREMSEN

SE SUMINISTRAN DESMONTADOS ENTRE 3 A 5 MINUTOS DE MONTAJE /

DELIVERED FLATPACKED BETWEEN 3 TO 5 MINUTES ASSEMBLY /

LIVRÉS DÉMONTÉS ENTRE 3 ET 5 MINUTES DE MONTAGE /

LIEFERUNG UNMONTIERT RÄDER MONTAGE ZWISCHEN 3 UND 5 MINUTEN



REF	TIPO / TYPE	€	U
90490*	4 X GN 1/1	1.182,65	1
90492	TAPA / COVER / TABLETTE / DECKEL	119,45	1
90493	TAPA / COVER / TABLETTE / DECKEL 1/1	42,70	1

WARM



**CARRO BUFFET ESPECIAL PARA TODO TIPO DE COMIDAS, FRÍAS, SEMI-FRÍAS O CALIENTES /
BUFFET TROLLEY SUITABLE FOR ALL KINDS OF FOOD, COLD, SEMI-COLD OR HOT /
CHARIOT BUFFET SPÉCIAL POUR TOUT TYPE DE NOURRITURES, FROIDES, SEMI-FROIDES OU CHAUDES /
BUFFETWAGEN GEIGNET FÜR ALLE MAHLZEITEN, KALT, WARM ODER GEMISCHT**

90495 Carro buffet 4 1/1 GN caliente / Buffet trolley 4 1/1 GN hot /
Chariot buffet 4 1/1 GN chaud / Buffetwagen (warm) 4 1/1 GN

SUPERFÍCIE SUPERIOR DE ABEDÚL FINLANDÉS DE ALTÍSIMA RESISTENCIA A AMBIENTES HÚMEDOS E INCLUSO A LA INTEMPERIE/

UPPER SURFACE OF FINNISH BIRCH, EXTREMELY RESISTANT TO HUMID ENVIRONMENTS AND EVEN OUTDOORS /

SURFACE SUPÉRIEURE EN BOULEAU FINLANDAIS, HAUTEMENT RÉSISTANTE AUX ENVIRONNEMENTS HUMIDES ET MÊME AUX INTEMPÉRIES /

OBERFLÄCHE FINNISCHER BIRKE, EXTREM WIDERSTANDSFÄHIG GEGEN FEUCHTE UND SOGAR IM FREIEN

ADAPTADO A MEDIDAS GASTRONORM / SUITABLE FOR GASTRONORM SIZES / ADAPTÉ AUX MESURES GASTRONORME / GEEIGNET FÜR GASTRONORMGRÖSSEN

EXCLUSIVE

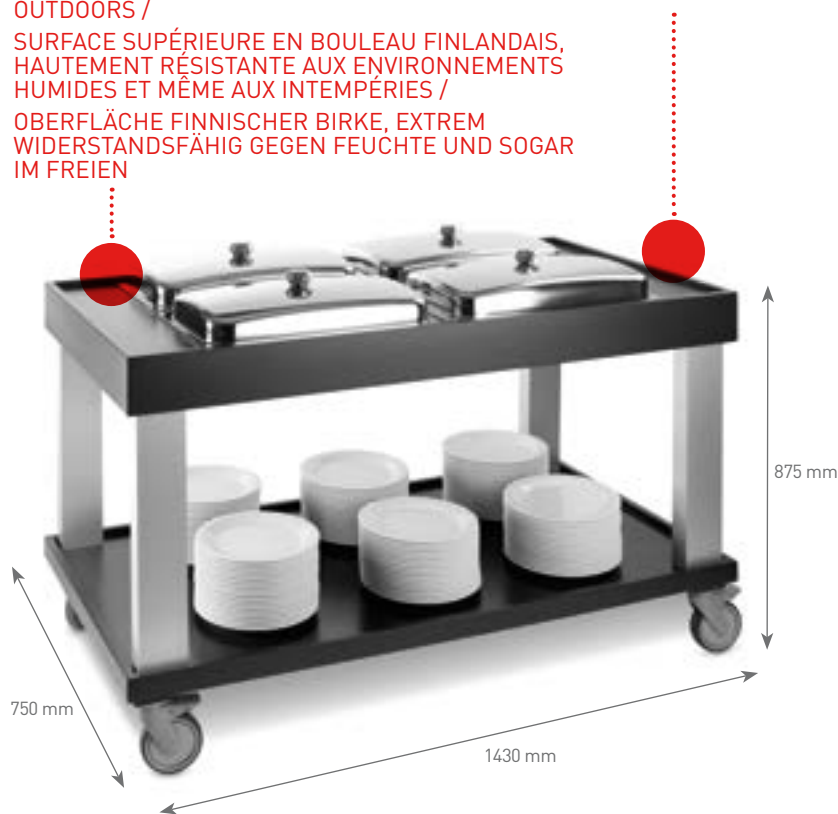

Opcional: se pueden adaptar placas de inducción /
Optional: can be adapted for induction plates /
Optionnel : on peut adapter des plaques à induction /
Zusatzausstattung: Passende Induktionsplatten verfügbar

***SE ENTREGA CON: 2 ELEMENTOS ELÉCTRICOS REF. 9500 + 4 CUBETAS GN 1/1 100 MM CON SOPORTE ELEMENTO ELÉCTRICO + 4 TAPAS GN 1/1 + 2 TAPAS MADERA /**

***COMES WITH: 2 ELECTRICAL ELEMENTS REF. 9500 + 4 TRAYS GN 1/1 100 MM WITH SUPPORT ELECTRIC ELEMENT + 4 COVERS GN 1/1 + 2 WOODEN COVERS /**

***FOURNI AVEC : 2 ÉLÉMENTS ÉLECTRIQUES RÉF. 9500 + 4 BACS GN 1/1 100 MM AVEC SUPPORT ÉLÉMENT ÉLECTRIQUE + 4 COUVERCLES GN 1/1 + 2 COUVERCLES BOIS /**

***IM LIEFERUMFANG ENTHALTEN: 2 ELEKTRISCHE ELEMENTE REF. 9500 + 4 SPEISEBEHÄLTER GN 1/1 100 MM MIT ELEKTRISCHEM ANSCHLUSS + 4 DECKEL GN 1/1 + 2 DECKEL, HOLZ**

INSTALACIÓN ELÉCTRICA PREPARADA PARA 4 ELEMENTOS ELÉCTRICOS /

ELECTRICAL SYSTEM DESIGNED FOR 4 ELECTRICAL ELEMENTS /

INSTALLATION ÉLECTRIQUE PRÉVUE POUR 4 ÉLÉMENTS

ÉLECTRIQUES / ELEKTRISCHE INSTALLATION VORBEREITET FÜR VIER ELEKTRISCHE ELEMENTE

LATERAL CON SOPORTE ESPECIAL PARA TAPAS CHAFING DISH /

SIDE WITH SPECIAL SUPPORT FOR CHAFING DISH COVERS /

PARTIE LATÉRALE AVEC SUPPORT SPÉCIAL POUR COUVERCLES CHAFING DISH /

SEITENELEMENTE MIT HALTERUNG FÜR DECKEL DES CHAFING-DISH



REF	TIPO / TYPE	€	U
90495*	4 x GN 1/1	2.298,00	1
90492	TAPA / COVER / TABLETTE / DECKEL	119,45	1
90493	TAPA / COVER / TABLETTE / DECKEL 1/1	42,70	1

CARROS DE SERVICIO EN MADERA / WOODEN SERVING TROLLEYS / CHARIOTS DE SERVICE EN BOIS / SERVIERWAGEN AUS HOLZ

TREND
CUBIC[®]
BY PUJADAS

Carro madera-aluminio 2 estanterías / wooden-aluminium trolley 2 shelves / Chariot en bois-aluminium 2 plateaux / Servierwagen Holz-Aluminium mit 2 Regalen

REF	COLOUR	€	U
80210	BLANCO / WHITE / BLANC / WEISS	537,35	1
80220	NEGRO / BLACK / NOIR / SCHWARZ	537,35	1

Ref. 80220



PIES EN ALUMINIO ANODIZADO / ANODISED ALUMINIUM FEET / PIEDS EN ALUMINIUM ANODISÉ / FÜSSE AUS ELOXIERTEM ALUMINIUM

RUEDAS GIRATORIAS E INSONORAS DE Ø 100 mm, DOS CON FRENO / SOUNDPROOF AND REVOLVING CASTORS Ø 100 mm, TWO WITH BRAKES / ROULETTES INSONORES ET PIVOTANTES DE Ø 100 mm, DEUX AVEC FREINS / BEWEGLICHE UND GRÄUSCHLOSE RÄDER Ø 100 mm, ZWEI MIT BREMSEN

Ref. 80210

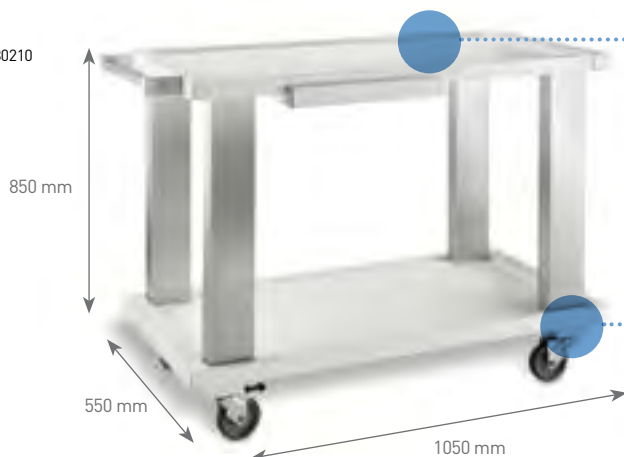

MADERA CON TRATAMIENTO HIDRÓFUGO / WOOD WITH WATERPROOF TREATMENT / BOIS AVEC UN TRAITEMENT HYDROFUGE / HOLZ MIT WASSERABWEISENDER BEHANDLUNG

SE SUMINISTRAN DESMONTADOS / DELIVERED FLATPACKED / LIVRÉS DÉMONTÉS / LIEFERUNG UNMONTIERT

Entre 3 a 5 minutos de montaje. Between 3 to 5 minutes assembly. Entre 3 et 5 minutes de montage. Montage zwischen 3 und 5 Minuten.

80219 Gueridón o carro auxiliar madera / wooden gueridon trolley / Chariot guéridon en bois / Abräum- oder Hilfswagen aus Holz

CUBIC[®]
BY PUJADAS

REF	COLOUR	€	U
80219	NEGRO / BLACK / NOIR / SCHWARZ	437,10	1

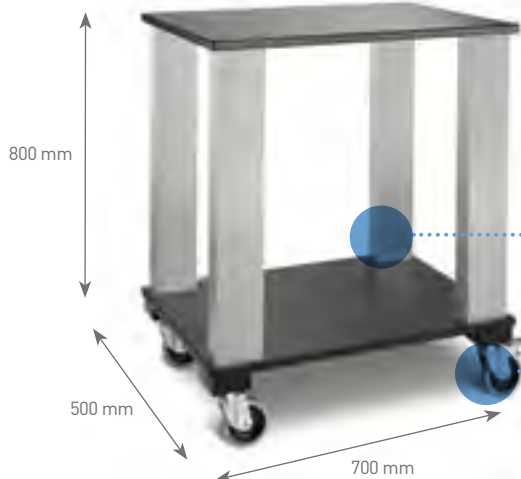

Madera con tratamiento hidrófugo. Wood with waterproof treatment. Bois avec un traitement hydrofuge. Holz mit wasserabweisender Behandlung.

Se suministran desmontados. Entre 3 a 5 minutos de montaje. Delivered flatpacked. Between 3 to 5 minutes assembly. Livrés démontés. Entre 3 et 5 minutes de montage. Lieferung unmontiert. Montage zwischen 3 und 5 Minuten.

PIES EN ALUMINIO ANODIZADO / ANODISED ALUMINIUM FEET / PIEDS EN ALUMINIUM ANODISÉ / FÜSSE AUS ELOXIERTEM ALUMINIUM

RUEDAS GIRATORIAS E INSONORAS DE Ø 100 mm, DOS CON FRENO / SOUNDPROOF AND REVOLVING CASTORS Ø 100 mm, TWO WITH BRAKES / ROULETTES INSONORES ET PIVOTANTES DE Ø 100 mm, DEUX AVEC FREINS / BEWEGLICHE UND GRÄUSCHLOSE RÄDER Ø 100 mm, ZWEI MIT BREMSEN

90813 Carro porta-cubiertos / Cutlery dispenser trolley / Chariot porte couverts / Transportwagen für besteck

EXCLUSIVE

CUBIC[®]
BY PUJADAS

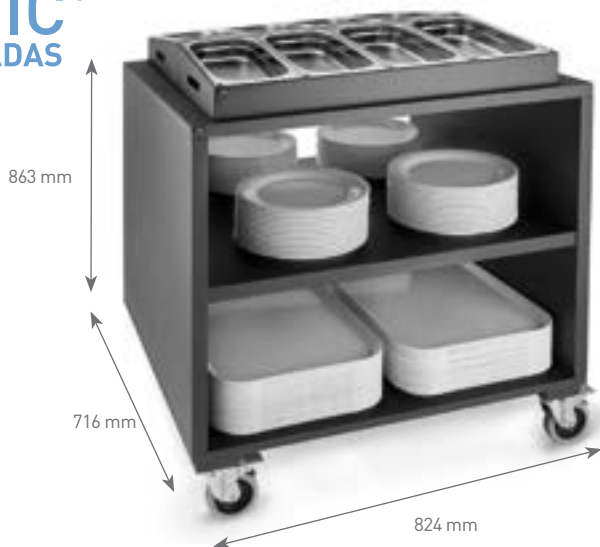

REF	€	U
90813	840,00	1



No incluye porta-cubiertos, cubetas GN, platos ni bandejas / Trays, dishes, GN containers and cutlery dispenser not included / Ramasse-couverts, bacs GN, assiettes, et plateaux pas compris / Besteckbehälter, GN behälter, platten und tablett nicht inklusive

90814 Porta-cubiertos / Cutlery bin / Ramasse-couverts / Besteckbehälter

EXCLUSIVE

CUBIC[®]
BY PUJADAS



4 x 1/3 GN
H max. 100 mm

REF	mm	€	U
90814	710 x 135 x 155	115,00	1



No incluye cubetas GN / GN containers not included / Bacs GN non inclus / GN behälter nicht inklusive

80216 Carro guerdón melamina roble / Oak melamine guerdon trolley / Chariot guerdon mélamine roure / Servierwagen aus eiche melamine

EXCLUSIVE

CUBIC[®]
BY PUJADAS



REF	€	U
80216	590,00	1

Se suministran desmontados. Entre 3 a 5 minutos de montaje / Delivered flatpacked. Between 3 to 5 minutes assembly / Livrés démontés. Entre 3 et 5 minutes de montage / Lieferung unmontiert räder. Montage zwischen 3 und 5 minuten

PIÉS EN ALUMINIO ANODIZADO NEGRO / BLACK ANODISED ALUMINIUM FEET / PIEDS EN ALUMINIUM ANODISÉ NOIR / MIT SCHWARZ, ELOXIERTEN ALUMINIUMSTÄNDERN

CON CHAPADO DE MELAMINA IMITACIÓN MADERA / WITH MELAMINE IMITATION WOOD VENEER / À REVÊTEMENT MÉLAMINÉ IMITATION BOIS / MIT MELAMINBESCHICHTUNG IN HOLZIMITATION

CARROS DE SERVICIO ALUMINIO / ALUMINIUM SERVING TROLLEYS / CHARIOT DE SERVICE EN ALUMINIUM / SERVICEWAGEN AUS ALUMINIUM

8090 Carro aluminio desembarace / Aluminium clearing trolley / Chariot débarrassage en aluminium / Aluminium Abräumwagen

EXCLUSIVE



REF	€	U
80900	317,20	1

Medidas de estantes adaptables a cubetas GN 1/1 y cestas FLAP-RACK® (500 x 500 mm). Carga máxima: total 150 Kg y con un máximo de 75 Kg por estante.

Racks adjustable to 1/1 GN containers and FLAP-RACK® (500 x 500 mm). Maximum load: 150 Kg and max. per level 75 Kg.

Clayettes adaptables à des bacs GN 1/1 et à casiers à vaisselle FLAP-RACK® (500 x 500 mm). Charge maximale: total 150 Kg et 75 Kg par niveau.

Masse der regale passend für GN behälter 1/1 und FLAP-RACK® spülkörbe (500 x 500 mm). Maximale tragkraft: total 150 Kg und maximal 75 Kg pro regal.

6411 Carro de servicio / Trolley / Chariot de service / Servierwagen



REF	DIM. ESTANTE / SHELF DIMENTION / DIM. NIVEAU / REGALGRÖSSE mm	€	U
641.100	780 x 485	198,80	1

Carga máxima 120 kgs
Maximum weight load 120 kgs
Charge maximale 120 kgs
Maximale Tragkraft 120 kg

Soportes de aluminio
Aluminium supports
Supports en aluminium
Aluminiumständer

642 / 643 Contenedor para cubiertos / Silverware container / Conteneur pour couverts / Besteckkasten
Contenedor para desperdicios / Refuse container / Conteneur pour déchets / Abfalleimer



REF	cm	Lts	€	U
642.000	32 x 19,5 x 16,5	9,00	28,05	1
643.000	33,5 x 23 x 56	80,00	56,25	1

640 Conjunto carro / Set trolley / Ensemble chariot / Servierwagenset



REF	DIM. ESTANTE / SHELF DIMENTION / DIM. NIVEAU / REGALGRÖSSE mm	€	U
640.000	780 x 485	300,10	1

CARRO SERVICIO ACERO INOXIDABLE / ST/STEEL SERVING TROLLEY / CHARIOT SERVICE EN ACIER INOXYDABLE / SERVIERWAGEN AUS EDELSTAHL

ESPAÑOL

ESTRUCTURA TUBULAR EN ACERO INOXIDABLE DE 1,5 mm ESPESOR.
ESTANTES INSONORIZADOS Y SOLDADOS A LA ESTRUCTURA TUBULAR (VERSIÓN CARROS MONTADOS).
RUEDAS GIRATORIAS INSONORAS DE ACERO Ø 125 mm. DOS DE ELLAS CON FRENO.
CARGA MÁXIMA: TOTAL 250 KG CON UN MÁXIMO DE 80 KG POR ESTANTE.

ENGLISH

1,5 mm THICK ST/STEEL TUBULAR FRAME.
SOUNDPROOF MOULDED SHELVES WELDED ON FRAME. (ONLY FOR ASSEMBLED TROLLEYS).
SOUNDPROOF REVOLVING CASTORS Ø 125 mm. TWO OF THEM WITH BRAKES.
MAXIMUM LOAD: 250 KG AND MAX. PER LEVEL 80 KG.

FRANÇAIS

STRUCTURE TUBULAIRE EN ACIER INOXYDABLE 1,5 mm ÉPAISSEUR.
PLATEAUX INSONORISÉS SOUDÉS À LA STRUCTURE TUBULAIRE. (VERSION CHARIOTS MONTÉS).
ROULETTES GIRATOIRES INSONORES DE Ø 125 mm. DEUX AVEC FREINS.
CHARGE MAXIMALE: TOTAL 250 KG ET 80 KG PAR NIVEAU.

DEUTSCH

STRUKTUR AUS EDELSATHLROHR VON 1,5 mm DICKE.
GERÄUSCHLOSE REGALE MIT DER STRUKTUR VERSCHWEISST. (VERSION MONTIERTE SERVIERWAGEN).
BEWEGLICHE GERÄUSCHLOSE RÄDER Ø 125 mm, ZWEI MIT BREMSEN.
MAXIMALE TRAGKRAFT: TOTAL 250 KG UND MAX 80 KG PRO REGAL.

Carro servicio acero inox / St/steel serving trolley / Chariot service en acier inox / Servierwagen Edelstahl

REF	ESTANTES / LEVELS / NIVEAUX / REGALE	DIM. ESTANTE / SHELF DIMENTION / DIM. NIVEAU / REGALGRÖSSE mm	A x B x C mm	€	U
80240	2	800 x 500	880 x 580 x 1015	368,50	1
80250	2	900 x 500	980 x 580 x 1015	431,10	1
80260*	2	1000 x 600	1080 x 680 x 1015	554,30	1
80270	3	800 x 500	880 x 580 x 1015	407,60	1
80280	3	900 x 500	980 x 580 x 1015	485,10	1
80290*	3	1000 x 600	1080 x 680 x 1015	583,20	1
80300	4	800 x 500	880 x 580 x 1300	618,35	1
80310	4	900 x 500	980 x 580 x 1300	685,00	1
80320*	4	1000 x 600	1080 x 680 x 1300	935,95	1

*Estantes de chapa de mayor espesor / Thicker shelves / Plateaux plus épais / Regal aus dickerem Blech

Disponible también con ruedas poliamida. Consultar precio.
Available also on polyamide castors. Please ask for price.
Disponible aussi avec roulettes polyamide. Consulter prix.
Auch lieferbar mit Polyamidrädern. Bitte Preis nachfragen.

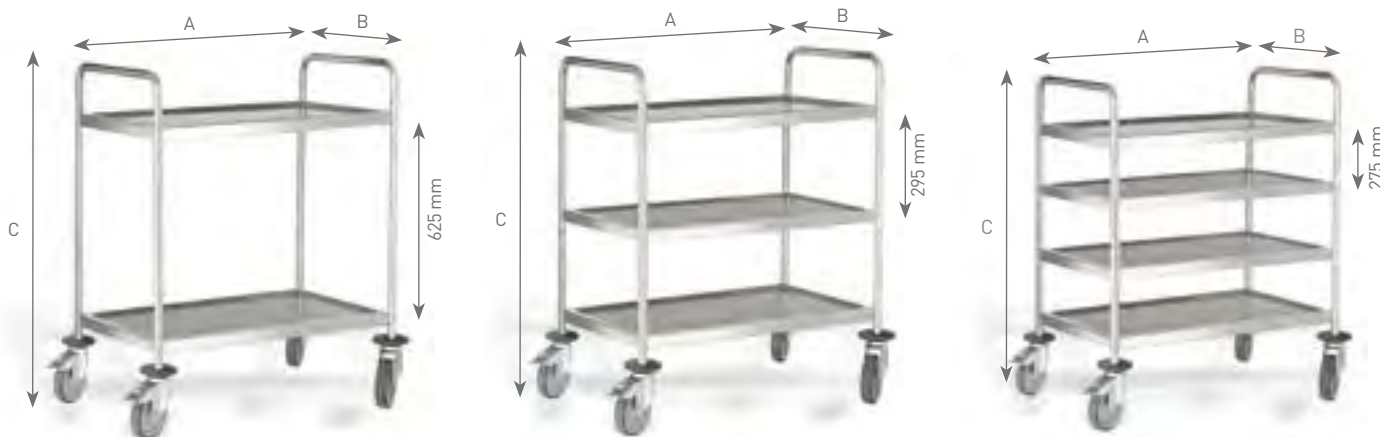

CARROS DE SERVICIO DESMONTABLES / DISASSEMBLED SERVING TROLLEYS / CHARIOTS DE SERVICE DÉMONTABLES / DEMONTIERBARE SERVIERWAGEN

..... ESPAÑOL
 SE ENTREGAN DESMONTADOS. MUY ROBUSTOS Y SÓLIDOS UNA VEZ MONTADOS. CARGA MÁXIMA POR BANDEJA DE 80 KG Y TOTAL MÁXIMO POR CARRO 250 KG. EL TIEMPO MEDIO DE MONTAJE ES DE 10 MINUTOS.

..... ENGLISH
 DELIVERED FLATPACKED. VERY STRONG AND RESISTANT ONCE ASSEMBLED. MAXIMUM LOAD PER SHELF IS 80 KG AND MAXIMUM PER TROLLEY IS 250 KG. APPROXIMATE TIME OF ASSEMBLY IS ABOUT 10 MINUTES.

..... FRANÇAIS
 LIVRÉS DÉMONTÉS. TRÈS ROBUSTES ET SOLIDES UNE FOIS MONTÉS. LA CHARGE MAX. PAR PLATEAU EST 80 KG ET PAR CHARIOT 250 KG. TEMPS MOYEN DE MONTAGE 10 MIN.

..... DEUTSCH
 LIEFERUNG UNMONTIERT. EINMAL MONTIERT SIND SIE SEHR ROBUST UND SOLIDE. MAXIMALE TRAGKRAFT PRO REGAL 80 KG UND TOTAL 250 KG. DIE MONTAGE DAUERT IM DURCHSCHNITT 10 MINUTEN.

Carro desmontable / Disassembled trolley / Chariot démontable / Demontierbarer Servierwagen

REF	ESTANTES / LEVELS / NIVEAUX / REGALE	DIM. ESTANTE / SHELF DIMENTION / DIM. NIVEAU / REGALGRÖSSE mm	A x B x C mm	€	U
80330	2	800 x 500	810 x 545 x 1040	409,95	1
80340	2	900 x 500	910 x 545 x 1040	475,20	1
80350	3	800 x 500	810 x 545 x 1040	483,00	1
80360	3	900 x 500	910 x 545 x 1040	572,65	1

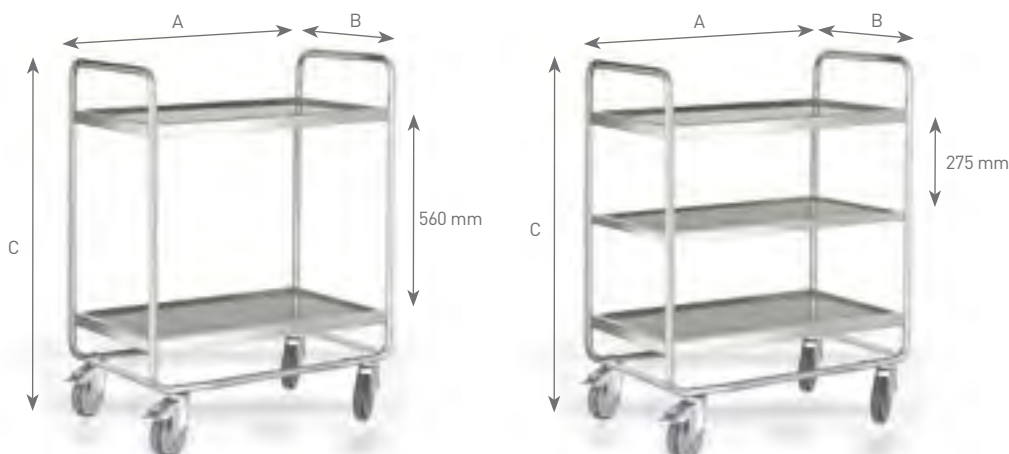

Carro desmontable ligero / Light disassembled trolley / Chariot démontable légère / Leichter demontierbarer Servierwagen

Ruedas acero Ø 100 mm. Dos con freno.
 Castors Ø 100 mm. Two with brakes.
 Roulettes Ø 100 mm. Deux avec freins.
 Edelstahlräder Ø 100 mm. Zwei mit Bremsen.

REF	ESTANTES / LEVELS / NIVEAUX / REGALE	DIM. ESTANTE / SHELF DIMENTION / DIM. NIVEAU / REGALGRÖSSE mm	€	U
80960	2	830 x 510	182,35	1
80961	3	830 x 510	217,85	1

GAMA ECONÓMICA / ECONOMIC LINE / GAMME ECONOMIQUE / ÖKONOMISCHE SERIE

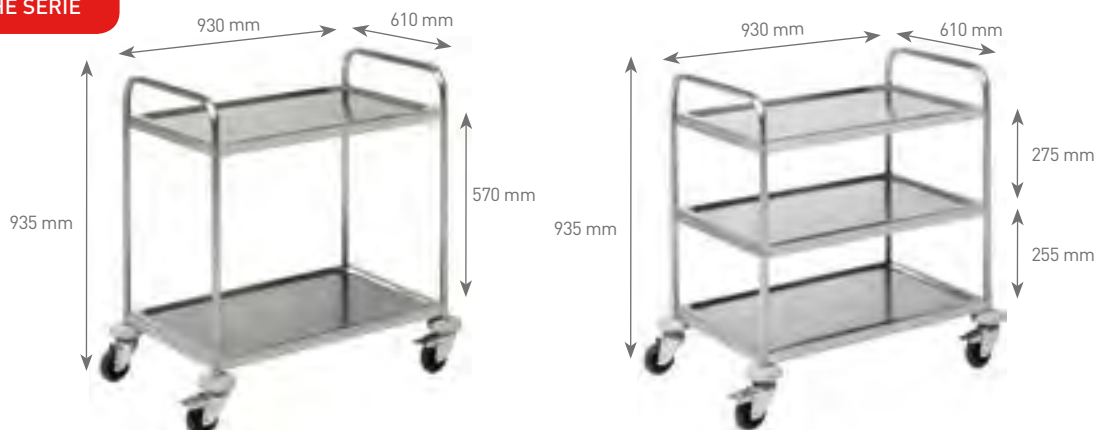

CARROS DE SERVICIO SOLDADOS / WELDED SERVING TROLLEYS / CHARIOTS DE SERVICE SOUDÉS / GESCHWEISSTE SERVIERWAGEN

8094 Carro servicio con barandilla / Serving trolley with guard-rail shelf / Chariot service avec galerie / Servierwagen mit Geländer

REF	ESTANTES / LEVELS / NIVEAUX / REGALE	DIM ESTANTE / SHELF DIMENTION / DIM NIVEAU / REGALGRÖSSE mm	€	U
80940	2	800 x 500	398,05	1
80941	3	800 x 500	523,80	1

Disponible también con ruedas poliamida. Consultar precio.
Available also on polyamide castors. Please ask for price.
Disponible aussi avec roulettes polyamide. Consulter prix.
Auch lieferbar mit Polyamidrädern. Bitte Preis nachfragen.



8068 Carro desembarace inox / St/Steel clearing trolley / Chariot de débarrassage en inox / Abräumwagen

REF	ESTANTES / LEVELS / NIVEAUX / REGALE	DIM ESTANTE / SHELF DIMENTION / DIM NIVEAU / REGALGRÖSSE mm	€	U
80680	2	1000 x 600	575,50	1

Disponible también con ruedas poliamida. Consultar precio.
Available also on polyamide castors. Please ask for price.
Disponible aussi avec roulettes polyamide. Consulter prix.
Auch lieferbar mit Polyamidrädern. Bitte Preis nachfragen.

No incluye cubeta Gastronorm 1/2.
1/2 Gastronorm container not included.
Bac Gastronorme 1/2 non inclus.
1/2 Gastronorm Behälter nicht im Preis inklusive.

Ø 165 mm



80374 Cubertero para carro servicio / Cutlery dispenser for serving trolley / Ramasse-couverts pour chariot service / Behälter für Servicewagen

REF	Mod	H mm	€	U
80374	GN 1/3	150	39,50	1





8080

Carro basculante 17 guías GN 1/1 / Swinging trolley 17 rails for 1/1 GN pans /
 Chariot basculant 17 glissières pour bacs GN 1/1 / Klappbarer Servierwagen mit 17 Einschüben für GN 1/1

PATENTED / EXCLUSIVE



REF	€	U
80800	892,00	1

Entrada 325 mm
 Entrance 325 mm
 Entrée 325 mm
 Eingang 325 mm

Carro especial para pequeños desniveles /
 Special trolley for uneven surfaces /
 Chariot spécial pour légers dénivelés /
 Spezieller Wagen für kleine Unebenheiten



Ideal para catering y cámaras frigoríficas /
 Ideal for catering service and cold rooms /
 Idéal pour traiteurs et chambres froides /
 Ideal für Catering oder Kühlkammern

8043

Carro 17 guías GN 1/1 / 17 rails trolley for 1/1 GN pans /
 Chariot 17 glissières pour bacs GN 1/1 / Servierwagen mit 17 Einschüben für GN 1/1



REF	€	U
80430	567,25	1

Entrada 325 mm
 Entrance 325 mm
 Entrée 325 mm
 Eingang 325 mm

Disponible también con ruedas poliamida. Consultar precio.
 Available also on polyamide castors. Please ask for price.
 Disponible aussi avec roulettes polyamide. Consulter prix.
 Auch lieferbar mit Polyamidrädern. Bitte Preis nachfragen.

8067

Carro doble 17 x 2 guías 1/1 / Double rail trolley 17 x 2 for 1/1 GN pans /
 Chariot double 17 x 2 glissières pour bacs GN 1/1 / Doppelservierwagen mit 17 x 2 Einschüben für GN 1/1



REF	€	U
80670	963,10	1

Entrada 325 mm
 Entrance 325 mm
 Entrée 325 mm
 Eingang 325 mm

Disponible también con ruedas poliamida. Consultar precio.
 Available also on polyamide castors. Please ask for price.
 Disponible aussi avec roulettes polyamide. Consulter prix.
 Auch lieferbar mit Polyamidrädern. Bitte Preis nachfragen.

CARROS CON GUÍAS / RAIL TROLLEYS / CHARIOT À GLISSIÈRES / SERVIERWAGEN MIT EINSCHÜBEN

8052 Carro encastrable 17 guías GN 1/1 / Stackable trolley 17 rails for 1/1 GN pans /
 Chariot emboîtable 17 glissières pour bacs GN 1/1 / Klappbarer Servierwagen mit 17 Einschüben für GN 1/1

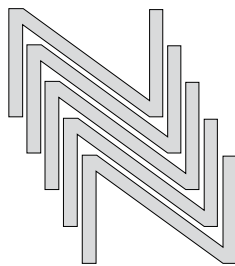

REF	€	U
80520	643,45	1

Entrada 325 mm
 Entrance 325 mm
 Entrée 325 mm
 Eingang 325 mm

Disponible también con ruedas poliamida. Consultar precio.
 Available also on polyamide castors. Please ask for price.
 Disponible aussi avec roulettes polyamide. Consulter prix.
 Auch lieferbar mit Polyamidrädern. Bitte Preis nachfragen.

8047 Carro desmontable 17 guías GN 1/1 / Disassembled trolley 17 rails for 1/1 GN pans /
 Chariot démontable 17 glissières pour bacs GN 1/1 / Demontierbarer Servierwagen mit 17 Einschüben für GN 1/1

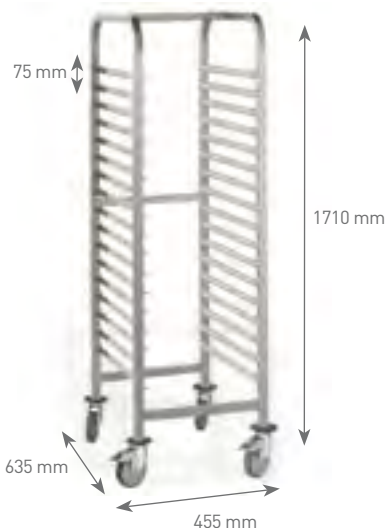

REF	€	U
80470	524,10	1

Entrada 325 mm
 Entrance 325 mm
 Entrée 325 mm
 Eingang 325 mm

Disponible también con ruedas poliamida. Consultar precio.
 Available also on polyamide castors. Please ask for price.
 Disponible aussi avec roulettes polyamide. Consulter prix.
 Auch lieferbar mit Polyamidrädern. Bitte Preis nachfragen.

Desmontado /
 Flat packed /
 Livré démonté /
 Demontiert

8097 Carro desmontable ligero 15 guías GN 1/1 / Light Disassembled trolley 15 rails for 1/1 GN pans /
 Chariot démontable léger 15 glissières pour bacs GN 1/1 /
 Leichter Demontierbarer Servierwagen mit 15 Einschüben für GN 1/1



REF	€	U
80970	395,15	1

Entrada 325 mm
 Entrance 325 mm
 Entrée 325 mm
 Eingang 325 mm

Ruedas acero Ø 120 mm. Dos con freno.
 Castors Ø 120 mm. Two with brakes.
 Roulettes Ø 120 mm. Deux avec freins.
 Edelstahlrollen Ø 120 mm. Zwei mit Bremsen.

GAMA ECONÓMICA /
 ECONOMIC LINE /
 GAMME ECONOMIQUE /
 ÖKONOMISCHE SERIE

8044 Carro 17 guías GN 2/1 / 17 rails trolley for 2/1 GN pans /
 Chariot 17 glissières pour bacs GN 2/1 / Servierwagen mit 17 Einschüben für GN 2/1



REF	€	U
80440	579,65	1

Entrada 530 mm
 Entrance 530 mm
 Entrée 530 mm
 Eingang 530 mm

Disponible también con ruedas poliamida. Consultar precio.
 Available also on polyamide castors. Please ask for price.
 Disponible aussi avec roulettes polyamide. Consulter prix.
 Auch lieferbar mit Polyamidrädern. Bitte Preis nachfragen.

8048 Carro desmontable 17 guías GN 2/1 / Disassembled trolley 17 rails for 2/1 GN pans /
 Chariot démontable 17 glissières pour bacs GN 2/1 / Demontierbarer Servierwagen mit 17 Einschüben für GN 2/1

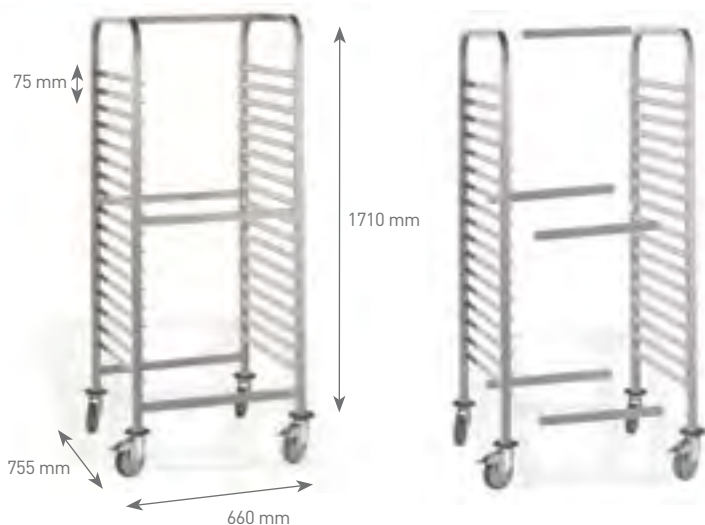

REF	€	U
80480	535,75	1

Entrada 530 mm
 Entrance 530 mm
 Entrée 530 mm
 Eingang 530 mm

Disponible también con ruedas poliamida. Consultar precio.
 Available also on polyamide castors. Please ask for price.
 Disponible aussi avec roulettes polyamide. Consulter prix.
 Auch lieferbar mit Polyamidrädern. Bitte Preis nachfragen.

Desmontado /
 Flat packed /
 Livré démonté /
 Demontiert

8051 Carro encastrable 17 guías GN 2/1 / Stackable trolley 17 rails for 2/1 GN pans /
 Chariot emboîtable 17 glissières pour bacs GN 2/1 / Klappbarer Servierwagen mit 17 Einschüben für GN 2/1

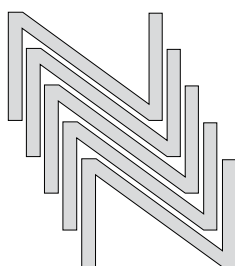

REF	€	U
80510	691,80	1

Entrada 530 mm
 Entrance 530 mm
 Entrée 530 mm
 Eingang 530 mm

Disponible también con ruedas poliamida. Consultar precio.
 Available also on polyamide castors. Please ask for price.
 Disponible aussi avec roulettes polyamide. Consulter prix.
 Auch lieferbar mit Polyamidrädern. Bitte Preis nachfragen.

8084 / 8085 / 8046 Carro pastelería / Pastry trolley / Chariot pâtisserie / Patisseriewagen



REF	MEDIDA GUÍAS / SIZE OF RAILS / DIMENSIONS GLISSIÈRES / EINSCHUBGRÖSSEN mm	Nº GUÍAS / NR. OF LEVELS / NUM. NIVEAUX / NR. EINSCHÜBE	DISTANCIA ENTRE GUÍAS / DISTANCE BETWEEN LEVELS / ESPACE ENTRE NIVEAUX / EINSCHUBABSTÄNDE mm	€	U
80840	600 x 400	15	85	573,45	1
80850	600 x 400	20	70	590,25	1
80460	600 x 400	30	45	624,80	1

Entrada 400 mm
Entrance 400 mm
Entrée 400 mm
Eingang 400 mm

Disponible también con ruedas poliamida. Consultar precio.
Available also on polyamide castors. Please ask for price.
Disponible aussi avec roulettes polyamide. Consulter prix.
Auch lieferbar mit Polyamidrädern. Bitte Preis nachfragen.

8087/8088/8050 Carro desmontable bandejas pastelería / Disassembled rail trolley for bakery / Chariots démontable pour plaques à pâtisserie / Demontierbarer Wagen für Patisserietabletts



REF	MEDIDA GUÍAS / SIZE OF RAILS / DIMENSIONS GLISSIÈRES / EINSCHUBGRÖSSEN mm	Nº GUÍAS / NR. OF LEVELS / NUM. NIVEAUX / NR. EINSCHÜBE	DISTANCIA ENTRE GUÍAS / DISTANCE BETWEEN LEVELS / ESPACE ENTRE NIVEAUX / EINSCHUBABSTÄNDE mm	€	U
80870	600 x 400	15	85	544,80	1
80880	600 x 400	20	70	560,80	1
80500	600 x 400	30	45	593,60	1

Entrada 400 mm
Entrance 400 mm
Entrée 400 mm
Eingang 400 mm

Disponible también con ruedas poliamida. Consultar precio.
Available also on polyamide castors. Please ask for price.
Disponible aussi avec roulettes polyamide. Consulter prix.
Auch lieferbar mit Polyamidrädern. Bitte Preis nachfragen.

Desmontado / Flat packed /
Livré démonté / Demontiert

8053 Carro encastrable pastelería 15 guías / Stackable pastry trolley 15 rails / Chariot emboîtable pâtisserie 15 glissières / Klappbarer Patisseriewagen 15 Einschübe



REF	€	U
80530	702,35	1

Disponible también con ruedas poliamida. Consultar precio.
Available also on polyamide castors. Please ask for price.
Disponible aussi avec roulettes polyamide. Consulter prix.
Auch lieferbar mit Polyamidrädern. Bitte Preis nachfragen.

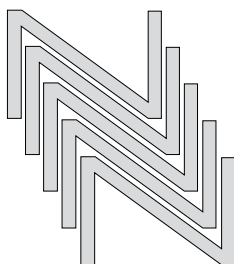

8081 Carro descongelación 9 guías / Defrost trolley 9 rails /
 Chariot à dégivrage 9 glissières / Auftauwagen mit 9 Einschüben

PATENTED EXCLUSIVE

REF	Mod	A x B x C mm	€	U
80810	GN 2/1	665 x 755 x 1720	1.034,05	1
80813	GN 1/1	455 x 635 x 1720	1.010,35	1



Ahorro de espacio en el proceso de descongelado de los alimentos
 Space saver while foodstuff defrost.
 Economie d'espace pendant le dégivrage des aliments.
 Platzsparend im Auftauverfahren von Lebensmitteln.

Disponible también con ruedas poliamida. Consultar precio.
 Available also on polyamide castors. Please ask for price.
 Disponible aussi avec roulettes polyamide. Consulter prix.
 Auch lieferbar mit Polyamidrädern. Bitte Preis nachfragen.



TRANSPORTE Y ALMACENAMIENTO /
 TRANSPORT & STORAGE /
 TRANSPORT ET STOCKAGE

80811 Cubeta especial GN para carro descongelación / Special GN container for defrost trolley /
 Bac GN spécial pour chariot dégivrage / Spezial GN Behälter zum Auftauen

REF	Mod	mm	H mm	Lts	€	U
80811	GN 2/1	650 x 530	100,0	28,90	96,05	1
80814	GN 1/1	530 x 325	100,0	14,20	47,80	1

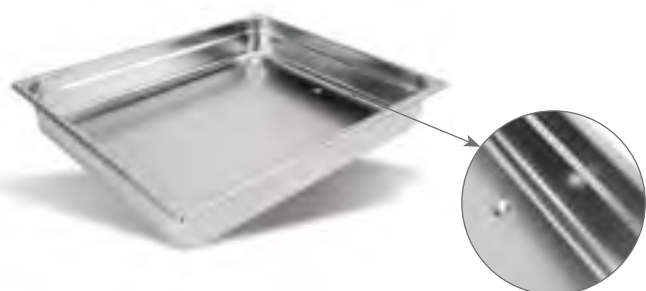

Cubeta con desagüe.
 Container with drainer hole.
 Bac avec dégorgeement.
 Behälter mit Abwasserloch.

215 / 115 Fondo perforado para cubeta / Perforated bottom /
 Egouttoir pour bac / Gelochter Einlegeboden für Behälter

REF	Mod	€	U
215.000 ¹	GN 2/1	76,05	1
115.000 ²	GN 1/1	37,40	1



¹ Recomendado para ref. 80811
 Recommended for item code 80811
 Recommandé pour réf. 80811
 Empfohlen für Art.Nr. 80811

² Recomendado para ref. 80814
 Recommended for item code 80814
 Recommandé pour réf. 80814
 Empfohlen für Art.Nr. 80814

CARROS CON GUÍAS / RAIL TROLLEYS / CHARIOT À GLISSIÈRES / SERVIERWAGEN MIT EINSCHÜBEN

ESPAÑOL

CARRO DE ACERO INOXIDABLE ESPECIALMENTE DISEÑADO PARA HORNOS DE PASTELERÍA Y PANIFICACIÓN. GUÍAS EN FORMA DE "L" CON TOPE ANTIDESLIZAMIENTO DE 90° PARA EVITAR DESPLAZAMIENTOS DE LAS BANDEJAS DURANTE SU TRANSPORTE.

ENGLISH

ST/STEEL TROLLEY SPECIALLY DESIGNED FOR PASTRY AND BAKERY OVENS. 90° "L" SHAPED RAILS TO AVOID MOVEMENTS OF TRAYS DURING TRANSPORTATION.

FRANÇAIS

CHARIOT EN ACIER INOXYDABLE SPÉCIALMENT CONÇU POUR FOURS DE PÂTISSERIE ET DE BOULANGERIE. GLISSIÈRES EN "L" A 90° POUR ÉVITER LES DÉPLACEMENTS PENDANT LE TRANSPORT.

DEUTSCH

WAGEN AUS ROSTFREIEM STAHL SPEZIELL FÜR PATISSERIE- UND BÄCKEREIBACKOFEN ENTWICKELT. EINSCHÜBE IN "L" FORM MIT 90° ANTIRUTSCHVERANKERUNG UM DAS VERRUTSCHEN DER TABLETTS BEIM TRANSPORT AUSZUSCHLIESSEN.



Ruedas giratorias de Ø 100 mm resistentes a altas temperaturas.
Revolving castors Ø 100 mm heat resistant.
Roulettes de Ø 100 mm résistantes à hautes températures.
Bewegliche Räder Ø 100 mm resistent gegen hohe Temperaturen.

- 30 °C
 + 280 °C

8089 Carro 17 guías para horno / Oven rail trolley 17 rails / Chariot pour four 17 glissières / Wagen für Backofen 17 Einschübe

ESPECIAL HORNO PANADERO /
SPECIAL TROLLEY FOR BAKERY /
CHARIOT SPECIAL BOULANGERIE /
SPEZIELL BÄCKEREIOFEN

REF	MEDIDA GUÍAS / SIZE OF RAILS / DIMENSIONS GLISSIÈRES / EINSCHUBGRÖSSE mm	€	U
80890	600 x 800	696,05	1
80891*	600 x 800	662,40	1

Entrada 600 mm
Entrance 600 mm
Entrée 600 mm
Eingang 600 mm

* Carro sin tejadillo acero inox
* Trolley without St/Steel roof
* Chariot sans toit en acier inox
* Wagen ohne Edelstahl Dach



8095 Carro self-service 12 guías / Self-service trolley 12 rails /
 Chariot self-service 12 glissières / Selbstbedienungswagen 12 Einschübe

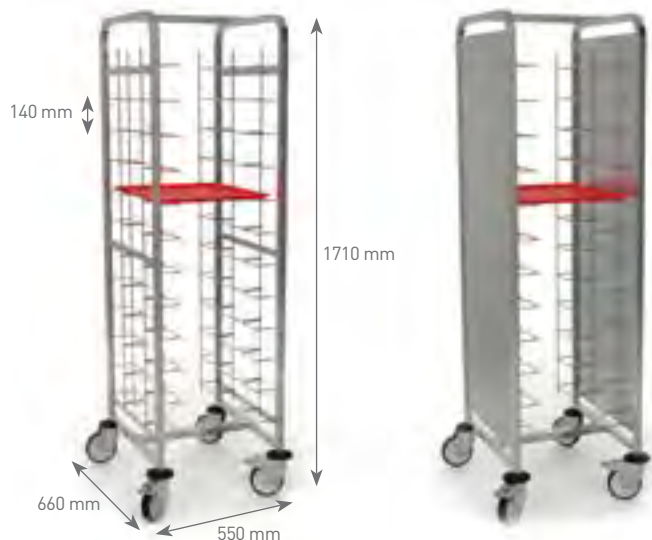

REF	€	U
80950	633,75	1
80951*	896,65	1
SC80957 Plafón lateral / Side Panel / Panneau latéral / Seitenwand	96,25	1

Para bandejas de ancho 365 mm hasta 420 mm
 For trays from 365 mm to 420 mm width
 Pour plateaux de 365 mm à 420 mm
 Für Tabletts der Breite von 365 mm bis 420 mm.

- * Con dos paneles laterales composite+aluminio.
- * With two side panels made of aluminium+composite .
- * Avec deux panneaux latéraux en composite+aluminium.
- * Mit zwei Seitenwänden aus composite+Aluminium.

8091 Carro doble para bandejas fast-food 12 guías / Double fast-food tray trolley 12 rails /
 Chariot double pour plateaux fast-food 12 glissières / Doppelwagen für Fast-Food Tabletts 12 Einschübe



REF	MEDIDA GUÍAS / SIZE OF RAILS / DIMENSIONS GLISSIÈRES / EINSCHUBGRÖSSE mm	€	U
80910	480 x 800	688,05	1

Entrada 480 mm
 Entrance 480 mm
 Entrée 480 mm
 Eingang 480 mm

Ideal para bandejas 480 x 370 mm
 Suitable for trays 480 x 370 mm
 Ideal pour plateaux 480 x 370 mm
 Ideal für Tabletts 480 x 370 mm

Disponible también con ruedas poliamida. Consultar precio.
 Available also on polyamide castors. Please ask for price.
 Disponible aussi avec roulettes polyamide. Consulter prix.
 Auch lieferbar mit Polyamidrädern. Bitte Preis nachfragen.

8049/8086 Carro desmontable bandejas hipermercado /
 Disassembled rail trolley for hipermarket trays /
 Chariots démontable à glissières pour plaques hypermarché /
 Demontierbarer Wagen für Grossmarkttabletts



REF	MEDIDA GUÍAS / SIZE OF RAILS / DIMENSIONS GLISSIÈRES / EINSCHUBGRÖSSE mm	Nº GUÍAS / NR. OF LEVELS / NUM. NIVEAUX / NR. EINSCHÜBE	DISTANCIA ENTRE GUÍAS / DISTANCE BETWEEN LEVELS / ESPACE ENTRE NIVEAUX / EINSCHUBABSTÄNDE mm	€	U
80490	585 x 410	15	85	535,75	1
80860	585 x 410	20	70	556,75	1

Entrada 410 mm
 Entrance 410 mm
 Entrée 410 mm
 Eingang 410 mm

Disponible también con ruedas poliamida. Precio consultar.
 Available also on polyamide castors. Please ask for price.
 Disponible aussi avec roulettes polyamide. Consulter prix.
 Auch lieferbar mit Polyamidrädern. Bitte Preis nachfragen.

925

Carro transporte bandejas isotérmicas / Transport trolley for isothermal trays /
Chariot transport plateaux isothermes / Transportwagen für isothermische Tablettis

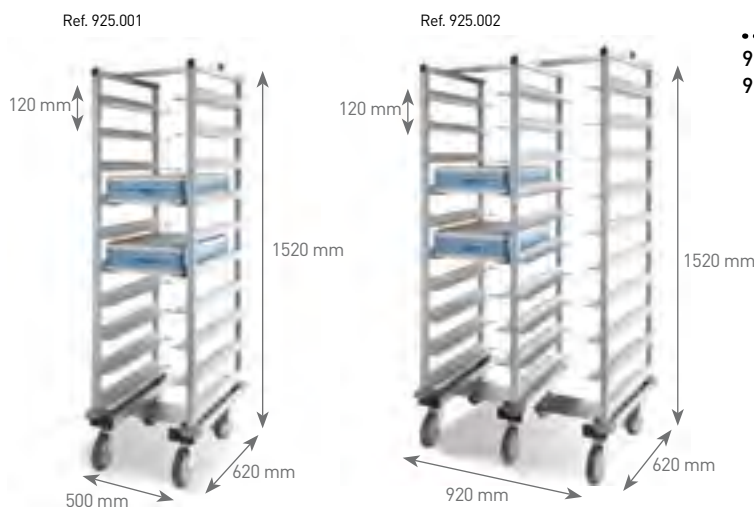

REF	MEDIDA GUÍAS / SIZE OF RAILS / DIMENSIONS GLISSIÈRES / EINSCHUBGRÖSSE / mm	Nº GUÍAS / NR. OF LEVELS / NUM. NIVEAUX / NR. EINSCHÜBE	€	U
925.001	550 x 375	10	936,25	1
925.002	550 x 375	20	1.251,65	1

8039

Carro porta cubetas GN / GN containers transport trolley /
Chariot transport bacs GN / Transportwagen für GN Behälter



REF	€	U
80390	530,70	1

No incluye cubetas GN.
GN containers not included.
Bacs GN non inclus.
GN Behälter nicht inklusive.

Disponible también con ruedas poliamida. Consultar precio.
Available also on polyamide castors. Please ask for price.
Disponible aussi avec roulettes polyamide. Consulter prix.
Auch lieferbar mit Polyamidrädern. Bitte Preis nachfragen.

8038

Carro porta cubeta GN 2/1 / 2/1 GN transport trolley /
Chariot transport bac GN 2/1 / Transportwagen für GN Behälter 2/1



REF	€	U
80380	478,60	1

No incluye cubetas GN.
GN containers not included.
Bacs GN non inclus.
GN Behälter nicht inklusive.

Disponible también con ruedas poliamida. Consultar precio.
Available also on polyamide castors. Please ask for price.
Disponible aussi avec roulettes polyamide. Consulter prix.
Auch lieferbar mit Polyamidrädern. Bitte Preis nachfragen.

Ref. 8039 / 8038

CARRO TRANSPORTE PARA CUBETAS GN
TRANSPORT TROLLEY FOR GN CONTAINERS
CHARIOTS DE TRANSPORT POUR BACS GN
TRANSPORTWAGEN FÜR GN BAEHÄLTER

Fabricados en acero inoxidable. Ideales para el almacenaje y transporte de alimentos preparados y salsas en grandes cantidades.
Made of St/Steel. Perfect for storing and transporting large quantities of prepared food and sauces.
Fabriqués en acier inoxydable. Idéales pour le stockage et le transport d'aliments cuisinés et sauces en grandes quantités.
Hergestellt aus Edelstahl. Ideal für die Lagerung und den Transport von vorbereiteten Lebensmittel und Sossen in grossen Mengen.

8074 Carro portacubiertos GN 1/3 y porta bandejas / Trolley cutlery dispenser GN 1/3 / Chariot porte-ramasse couverts GN 1/3 / Transportwagen für GN 1/3 Besteckbehälter und Tablett



REF	€	U
80740	435,55	1

No incluye cubetas GN.
GN containers not included.
Bacs GN non inclus.
GN Behälter nicht inklusive.

Disponible también con ruedas poliamida. Consultar precio.
Available also on polyamide castors. Please ask for price.
Disponible aussi avec roulettes polyamide. Consulter prix.
Auch lieferbar mit Polyamidrädern. Bitte Preis nachfragen.

8057 Carro para cargas pesadas / Trolley for heavy loads / Chariot à charges lourdes / Wagen für schwere Last

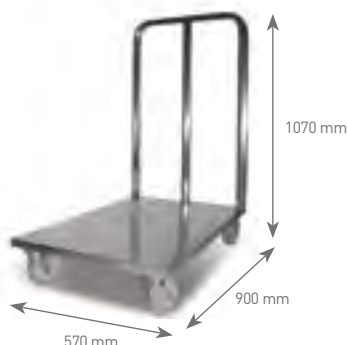

REF	€	U
80570	643,05	1

Carga máxima: 350 kg
Maximum load: 350 kg
Charge maximale: 350 kg
Maximale Tragkraft: 350 kg

8054 Carro transporte bandejas 7 guías / Tray transport trolley 7 rails / Chariot transport plateau 7 glissières / Tabletttransportwagen 7 Einschübe

REF	MEDIDA GUÍAS / SIZE OF RAILS / DIMENSIONS GLISSIÈRES / EINSCHUBGRÖSSE	A x B x C mm	DISTANCIA ENTRE GUÍAS / DISTANCE BETWEEN LEVELS / ESPACE ENTRE NIVEAUX / EINSCHUBABSTAND mm	€	U
80540	GN 1/1	455 x 635 x 900	75	451,05	1
80550	GN 2/1	660 x 750 x 900	75	505,65	1
80560	Pastelería / Pastry / Pâtisserie / Patisserie (600 x 400 mm)	525 x 700 x 900	85	492,00	1
80780	GN 1/1 Doble	810 x 635 x 900	75	834,45	1

Ref. 80540

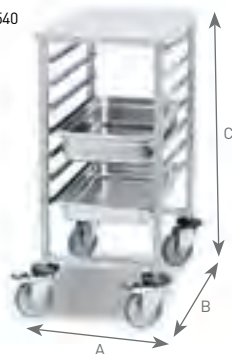

Ref. 80780

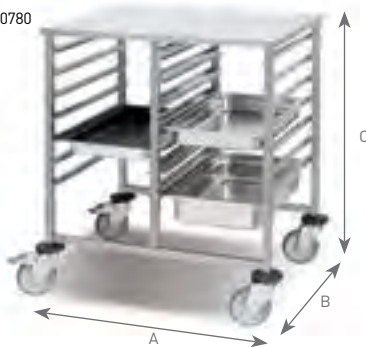

Disponible también con ruedas poliamida. Consultar precio.
Available also on polyamide castors. Please ask for price.
Disponible aussi avec roulettes polyamide. Consulter prix.
Auch lieferbar mit Polyamidrädern. Bitte Preis nachfragen.

8061 / 8062 / 8063 Fundas desechables de polietileno para carros (rollo de 100 unidades) / Disposable covers for trolleys (pack 100 pieces) / Housses jetables pour chariots (rouleau de 100 unités) / Einweghüllen aus Polyethylen für Wagen (Rollen von 100 Stück)



REF	€	U
80610 para carro 1/1 / for trolley 1/1 / pour chariot 1/1 / für Wagen 1/1	180,75	1
80620 para carro 2/1 / for trolley 2/1 / pour chariot 2/1 / für Wagen 2/1	203,55	1
80630 para carro pastelería 600 x 400 / for pastry trolley 600 x 400 / pour chariot pâtisserie 600 x 400 / für Patisseriewagen 600 x 400	183,60	1
80640 dispensador / dispenser / distributeur / Rollenhalter	189,65	1

Polietileno de densidad media.
Medium density polyethylene.
Poliéthylène de densité moyenne.
Polyethylen mittlere Stärke.

Para carros altos.
For high trolleys.
Pour chariots hauts.
Für hohe Wagen.

5015 / 5017 Carro de plástico para cestas / Plastic trolley for dishwasher racks / Chariot pour casiers à vaisselle / Plastikwagen für Spülkörbe

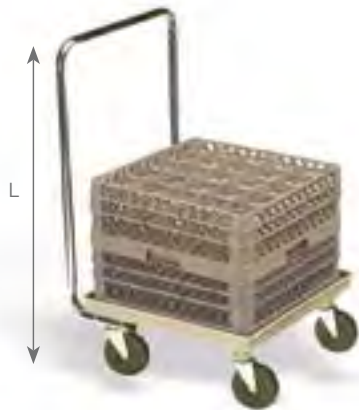

REF		L mm	€	U
5015	sin asa / without handle / sans anse / ohne Griff	230	92,20	1
5017	con asa / with handle / avec anse / mit Griff	980	143,45	1

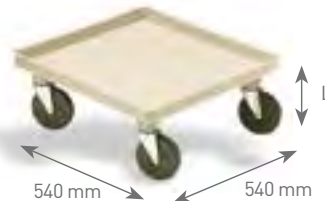

8058 / 8059 Carro inox para cestas / St/steel trolley for dishwasher racks / Chariot inox pour casiers à vaisselle / Edelstahlwagen für Spülkörbe

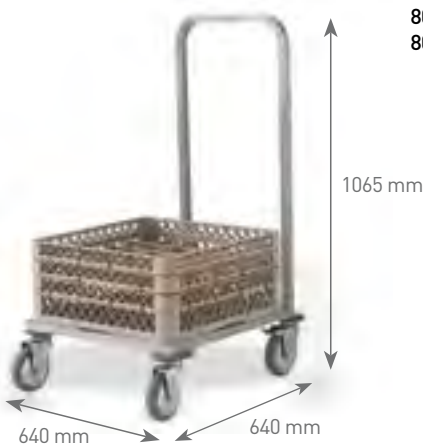

REF		€	U
80580	con asa / with handle / avec anse / mit Griff	345,30	1
80590	sin asa / without handle / sans anse / ohne Griff	230,20	1

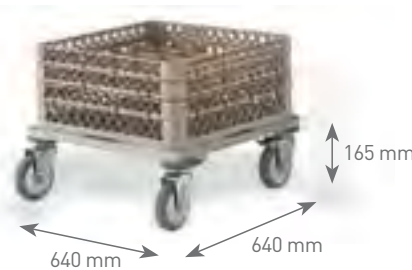

8075 / 8076 / 8077 Carro para cestas Vajillas / Dishwasher rack trolley / Chariot casiers à vaisselle / Wagen für Spülkörbe



REF	MEDIDA GUÍAS / SIZE OF RAILS / DIMENSIONS GLISSIÈRES / EINSCHUBGRÖSSE mm	Nº GUÍAS / NR. OF LEVELS / NUM. NIVEAUX / NR. EINSCHÜBE	A x B x C mm	€	U
80750	500 x 500	5	640 x 633 x 1160	433,85	1
80760	500 x 500	9	640 x 633 x 1710	662,90	1
80770	500 x 500 (doble/double)	9	1185 x 633 x 1710	885,40	1



8082 Carro ajustable para platos / Adjustable dish caddy /
 Chariot modulable pour assiettes / Einstellbarer Tellerwagen



REF	€	U
80820	1.138,40	1

Se sirve con 4 columnas separadoras más una funda protectora.
 Delivered with 4 posts plus 1 protection cover.
 Livré avec 4 colonnes de séparation et 1 housse de protection.
 Lieferung mit 4 Unterteilungssäulen und einer Schutzhülle.

Ajuste único y fácil por la parte superior.
 Unique and easy adjustment from the top.
 Reglage unique et facile de la partie supérieure.
 Einzigartige und einfache Einstellung des Oberteils.

COMBINACIONES /
 COMBINATIONS /
 COMBINATIONS /
 KOMBINATIONEN

Tamaño platos
 Size plates
 Taille assiettes
 Tellergröße

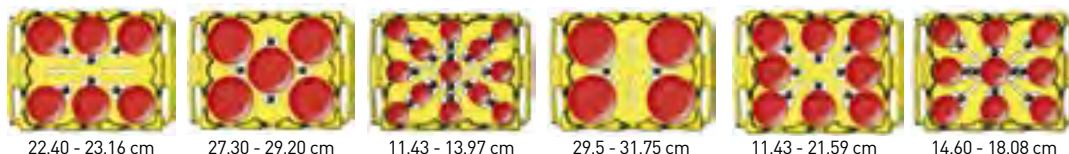

8092 Carro ajustable para platos cuadrados y redondos / Adjustable caddy for square & round dishes /
 Chariot modulable pour assiettes carrées et rondes / Einstellbarer Wagen für runde und quadratische Teller



Diseño exclusivo apilable.
 Unique, stackable design.
 Design exclusif empilable.
 Exclusives Design stapelbar.

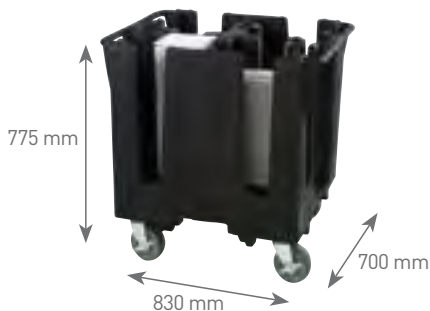

REF	€	U
80920	950,65	1

Se sirve con 5 columnas separadoras una de ellas en forma de cruz más una funda protectora.
 Delivered with 5 posts, one of them in cross shape plus 1 protection cover.
 Livré avec 5 colonnes de séparation une desquelles en forme de croix plus 1 housse de protection.

Livré avec 5 colonnes de séparation une desquelles en forme de croix plus 1 housse de protection.
 Lieferung mit 5 Unterteilungssäulen, eine von Ihnen in Kreuzform und einer Schutzhülle.

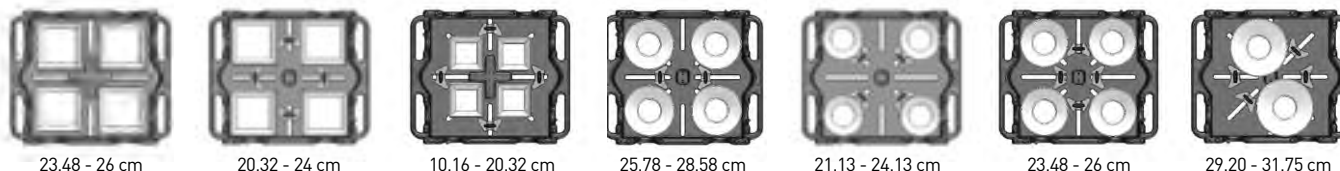

80821 Columna separadora carro platos / Post for dish trolley /
 Colonne séparation chariot assiettes / Unterteilungssäule für Tellerwagen



REF	€	U
80821	68,30	1

Compatible ref: 8082 y 8092.
 Compatible ref: 8082 & 8092.
 Compatible réf: 8082 et 8092.
 Passend für Art.Nr.: 8082 und 8092.

80822 / 80922 Funda protectora de vinilo para carro platos / Vinyl cover for dish trolley /
 Housse protection en vynil pour chariot assiettes / Vynilschutzhülle für Tellerwagen



REF	€	U
80822 ¹	74,95	1
80922 ²	62,10	1

¹ Funda para ref. 8082 / Cover for item 8082 /
 Housse pour réf. 8082 / Hülle für Art.Nr. 8082
² Funda para ref. 8092 / Cover for item 8092 /
 Housse pour réf. 8092 / Hülle für Art.Nr. 8092

TRANSPORTE Y ALMACENAMIENTO /
 TRANSPORT & STORAGE /
 TRANSPORT ET STOCKAGE

ESTANTERÍAS MODULARES DE ALUMINIO Y POLIPROPILENO /
ALUMINIUM AND POLYPROPYLENE MODULAR SHELVING /
ÉTAGÈRES MODULABLES EN ALUMINIUM ET POLYPROPYLÈNE /
KOMBINIERBARE REGALMODULE AUS ALUMINIUM UND POLYPROPYLEN

ESPAÑOL

ANTICORROSION - ESTANTERÍAS INOXIDABLES FABRICADAS CON ESTRUCTURA DE ALUMINIO ANODIZADO ESPECIAL QUE LAS HACE RESISTENTES AL FRÍO Y AL CALOR, LLEGANDO A SOPORTAR DESDE -30 °C HASTA +75 °C. ESTANTES/PARRILLAS DE POLIPROPILENO APTO PARA USO ALIMENTARIO.

ENGLISH

ANTICORROSIVE - RUST-RESISTANT SHELVING. MANUFACTURED WITH SPECIAL ANODISED ALUMINIUM FRAME PROVIDING COLD AND HEAT RESISTANCE FROM -30 °C TO +75 °C. POLYPROPYLENE RACK/SHELVES, SUITABLE FOR FOODSTUFFS USE.

FRANÇAIS

ANTI-CORROSION - ÉTAGÈRES INOXYDABLES, FABRIQUÉES AVEC UNE STRUCTURE EN ALUMINIUM ANODISÉ SPÉCIAL QUI LES FAIT RÉSISTANTES À LA CHALEUR ET AU FROID, DE -30 °C JUSQU'ÀUX +75 °C. CLAYETTES EN POLYPROPYLÈNE ALIMENTAIRE.

DEUTSCH

ANTIKORRUSION - NICHT ROSTENDE REGALE AUS SPEZIAL ELOXIERTEM ALUMINIUM HERGESTELLT, WELCHES SIE RESISTENT GEGEN KÄLTE UND WÄRME MACHT (VON -30 °C BIS +75 °C). REGALE UND BÖDEN AUS POLYPROPYLEN GEEIGNET FÜR LEBENSMITTEL.



FACILIDAD Y RAPIDEZ DE MONTAJE /
EASY AND QUICK ASSEMBLY /
FACILE ET RAPIDE MONTAGE /
EINFACHE UND SCHNELLE MONTAGE

ROBUSTEZ Y RESISTENCIA

MUY ROBUSTAS Y RESISTENTES CON UNA CAPACIDAD DE CARGA POR ESTANTE DE 150 KG (CARGA REPARTIDA UNIFORMEMENTE A LO LARGO DE TODO EL ESTANTE) Y TOTAL POR CONJUNTO ESTANTERÍA DE 420 KG.

ESTANTES/PARRILLAS CON UN DISEÑO ESPECIAL QUE DA GRAN ROBUSTEZ A LA MISMA Y HACE QUE EL APOYO SOBRE LA ESTANTERÍA SEA MUY FIRME Y RESISTENTE.

ROBUSTNESS AND RESISTANCE

VERY STRONG AND RESISTANT WITH A LOAD CAPACITY PER SHELF OF 150 KG (UNIFORMLY DISTRIBUTED LOAD ALONG THE ENTIRE SHELF) AND 420 KG TOTAL SHELVING.

RACK/SHELVES WITH A SPECIAL DESIGN PROVIDING ROBUSTNESS TO ITSELF AND PROVIDING ALSO A VERY STRONG AND RESISTANT SUPPORT ON THE FRAME.

ROBUSTESSE ET RESISTANCE

TRÈS ROBUSTES ET RÉSISTANTES, AVEC UNE CHARGE MAXIMALE DE 150 KG (POIDS RÉPARTIE UNIFORMEMENT TOUT AU LONG DE L'ÉTAGÈRE) PAR NIVEAU ET 420 KG DE CHARGE TOTALE.

CLAYETTES AVEC UN DESSIN QUI DONNE UNE GRANDE ROBUSTESSE ET UN APPUI TRÈS FERME ET SOLIDE SUR LA STRUCTURE.

ROBUST UND RESISTENT

SEHR ROBUST UND RESISTENT MIT EINER TRAGKRAFT VON 150 KG PRO REGALBODEN (LAST GLEICHMÄSSIG AUF DER LÄNGE DES REGALBODENS VERTEILT) UND DIE GESAMTTRAGKRAFT DES REGALS BETRÄGT 420 KG.

REGALBÖDEN/GITTER MIT SPEZIELLEM DESIGN, WELCHES EINE GROSSE ROBUSTHEIT ANSICH VERLEIHT UND EINEN SEHR SICHEREN UND RESISTENTEN HALT GARANTIERT.

ESTANTERÍAS MODULARES DE ALUMINIO Y POLIPROPILENO /
ALUMINIUM AND POLYPROPYLENE MODULAR SHELVING /
ÉTAGÈRES MODULABLES EN ALUMINIUM ET POLYPROPYLÈNE /
KOMBINIERBARE REGALMODULE AUS ALUMINIUM UND POLYPROPYLEN

ESPAÑOL

COMPATIBILIDAD CON GASTRONORM

MEDIDAS ADAPTADAS A LA NORMA GASTRONORM. HAY DOS FONDOS DISPONIBLES, GASTRONORM 1/1 Y 2/3, QUE PERMITEN COLOCAR INDISTINTAMENTE TANTO LOS ESTANTES/PARILLAS O DIRECTAMENTE CUBETAS GASTRONORM 1/1 Ó 2/3 SEAN DE ACERO INOXIDABLE O DE POLICARBONATO (COMPATIBLES CON LA MAYORÍA DE CUBETAS GASTRONORM DEL MERCADO).

ENGLISH

GASTRONORM COMPATIBILITY

ADAPTED TO GASTRONORM SIZES. TWO AVAILABLE DEPTHS, 1/1 AND 2/3 GASTRONORM SIZES. IT IS POSSIBLE TO PUT EQUALLY THE RACK/SHELVES OR DIRECTLY THE 1/1 AND 2/3 GASTRONORM CONTAINERS, ST/STEEL OR POLYCARBONATE (COMPATIBLE WITH MOST OF GASTRONORM PANS OF THE MARKET).

FRANÇAIS

COMPATIBILITÉ AVEC GASTRONORME

ÉTAGÈRES ADAPTÉES AUX DIMENSIONS GASTRONORME. DEUX PROFONDEURS DISPONIBLES, GASTRONORME 1/1 ET 2/3. ON PEUT PARFAITEMENT Y POSER INDISTINCTEMENT LES CLAYETTES OU DIRECTEMENT LES BACS GASTRONORME 1/1 OU 2/3 SOIT EN INOX OU EN POLYCARBONATE (COMPATIBLES AVEC LA PLUPART DES BACS DU MARCHÉ).

DEUTSCH

PASSEND FÜR GASTRONORM

PASSEND FÜR GASTRONORMGRÖSSEN. ES GIBT ZWEI LIEFERBARE TIEFEN, GASTRONORM 1/1 UND 2/3. SOWOHL DIE REGAL/GITTERBODEN ALS AUCH DIE GASTRONORMBEHÄLTER 1/1 UND 2/3 AUS EDELSTAHL ODER POLYCARBONAT SIND IN DEN RAHMEN EINSETZBAR (PASSEND FÜR DIE MEISTEN GASTRONORMBEHÄLTER AUF DEM MARKT).



ALUMINIO Y POLIPROPILENO / ALUMINIUM AND POLYPROPYLENE /
ALUMINIUM ET POLYPROPYLÈNE / ALUMINIUM UND POLYPROPYLEN

Parrillas / Rack shelves / Clayettes / Gitterböden

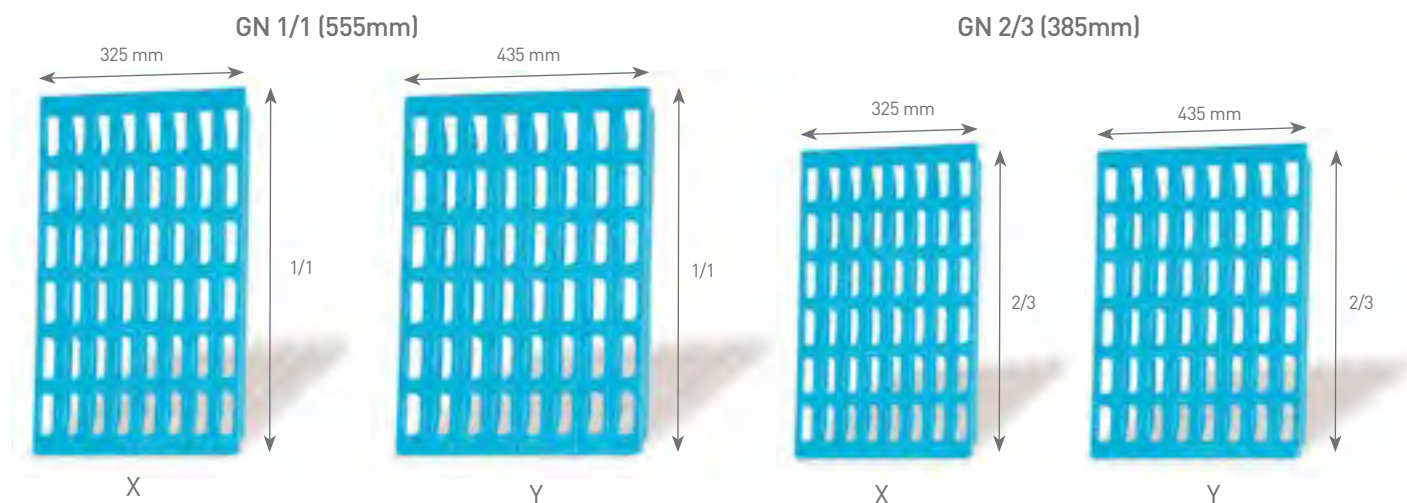

Apto para lavavajillas
Dishwasher safe
Apte pour lave-vaisselle
Geeignet für Spülmaschinen

Combinando parrillas de la misma profundidad (X/Y) permite personalizar las longitudes de las estanterías a cada una de las necesidades. (Ver en página siguiente combinaciones propuestas)

Combining rack shelves among the same group (X/Y) allows to personalize the lengths of each shelf. (Refer to next page for proposed combinations)

En combinant des clayettes du même groupe (X/Y) permet de personnaliser les longueurs des étagères à n'importe quel besoin. (Voir page suivante pour des combinaisons proposées)

Die Kombination der Gitterböden gleicher Tiefe (X/Y) erlaubt die Länge der Regale individuell je nach Bedarf zu bestimmen. (Siehe Kombinerungsvorschläge folgende Seite)

Pieza soporte travesaños / Support for grossbars / Crochet support pour largerons / Halterungsteil Traversen

Sistema especial de fijación de soporte para travesaños que ofrece la máxima seguridad, fiabilidad y robustez.

Special fixing system support for crossbars which offers the highest security, reliability and robustness.

Système spécial de fixation des supports pour longerons qui offre la sécurité, fiabilité et robustesse maximale.

Spezielles System der Halterverankerung für die Traversen, welches die höchste Sicherheit, Zuverlässigkeit und Robustheit bietet.



Pies regulables / Leveling feet / Pieds régulateurs / Regulierbare Füße

Pies regulables con rosca oculta para suelos con desniveles. Con la posibilidad de adaptar ruedas de Ø 125 mm.

Levelling feet with hidden thread, for gradient floors. It is also possible to adapt Ø 125 mm wheels.

Pieds régulateurs avec filet cache.

Il est aussi possible d'y adapter des roues de Ø 125 mm.

Regulierbare Füße mit verborgenem Gewinde für unebene Böden. Mit der Möglichkeit Räder Ø 125 mm anzubringen.

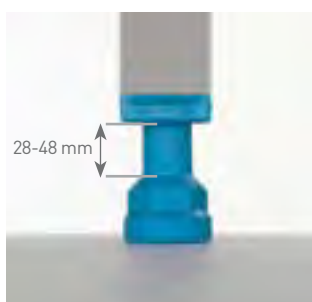

Alturas estándar de los niveles / Standard heights of levels / Hauteur standard des niveaux / Standardhöhe der Ebenen

Altura 1280 mm / 3 niveles
Height 1280 mm / 3 levels
Hauteur 1280 mm / 3 niveaux
Höhe 1280 mm / 3 Ebenen

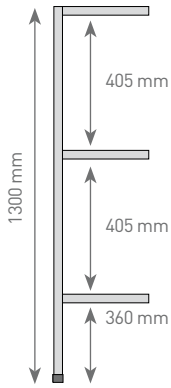

Altura 1750 mm / 3 niveles
Height 1750 mm / 3 levels
Hauteur 1750 mm / 3 niveaux
Höhe 1750 mm / 3 Ebenen

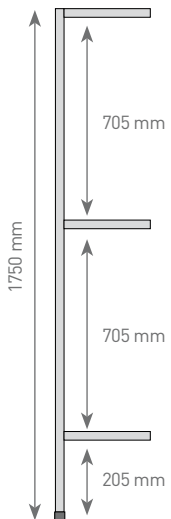

Altura 2050 mm / 4 niveles
Height 2050 mm / 4 levels
Hauteur 2050 mm / 4 niveaux
Höhe 2050 mm / 4 Ebenen

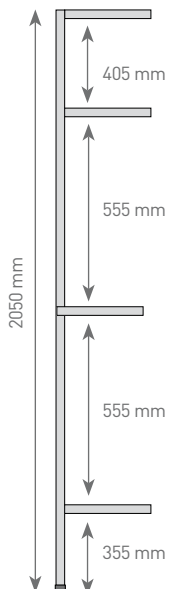

Altura 1750 mm / 4 niveles
Height 1750 mm / 4 levels
Hauteur 1750 mm / 4 niveaux
Höhe 1750 mm / 4 Ebenen

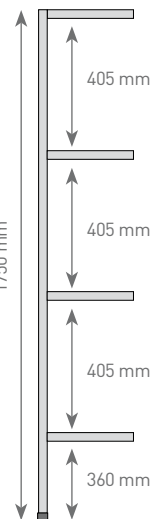

Altura 2050 mm / 5 niveles
Height 2050 mm / 5 levels
Hauteur 2050 mm / 5 niveaux
Höhe 2050 mm / 5 Ebenen

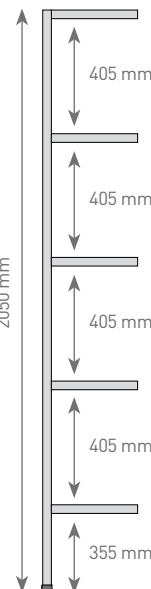

Altura 1750 mm / 5 niveles
Height 1750 mm / 5 levels
Hauteur 1750 mm / 5 niveaux
Höhe 1750 mm / 5 Ebenen

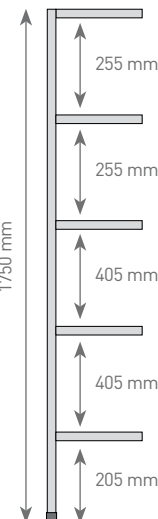

Altura 2050 mm / 6 niveles
Height 2050 mm / 6 levels
Hauteur 2050 mm / 6 niveaux
Höhe 2050 mm / 6 Ebenen

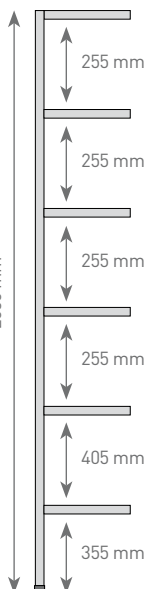

Combinaciones /
Combinations /
Combinaisons /
Kombinationen

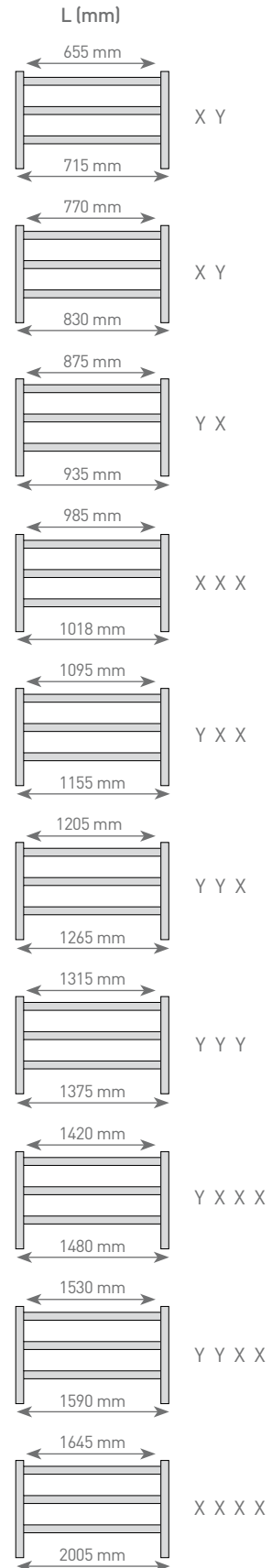

**ESTANTES (PARRILLAS + TRAVESAÑOS) / SHELVES (RACK/SHELVES + CROSSBARS) /
 NIVEAU COMPLET (CLAYETTES + LONGERONS) / REGALE (GITTEBÖDEN + TRAVERSEN)**

Fondo 385 mm. Adaptable a las cubetas gastronorm 2/3
 Depth 385 mm. Suitable for 2/3 gastronorm containers
 Profondeur 385 mm. Adaptable aux bacs gastronorme 2/3
 Tiefe 385 mm. Passend für Gastronormbehälter 2/3

X significa una parrilla de ancho 325 mm.
 Y significa una parrilla de ancho 435 mm.

X is a rack 325 mm width.
 Y is a rack 435 mm width.

X est une clayette de 325 mm de largeur.
 Y est une clayette de 435 mm de largeur.

X Bezeichnet einen Einlegeboden der Breite von 325 mm.
 Y Bezeichnet einen Gitterboden der Breite von 435 mm.

REF	MOD	COMBINACIÓN / COMBINATION / COMBINAISON / KOMBINATION	A mm	B mm	€
7575	T61	X + X	655	385	34,35
7576	T71	X + Y	770	385	38,05
7577	T81	Y + Y	875	385	41,00
7578	T91	X + X + X	985	385	44,45
7579	T101	Y + X + X	1095	385	48,65
7580	T111	Y + Y + X	1205	385	52,90
7581	T131	Y + Y + Y	1315	385	57,70
7582	T141	Y + X + X + X	1420	385	61,65
7583	T151	Y + Y + X + X	1530	385	65,95
7584	T161	Y + Y + Y + X	1645	385	70,30

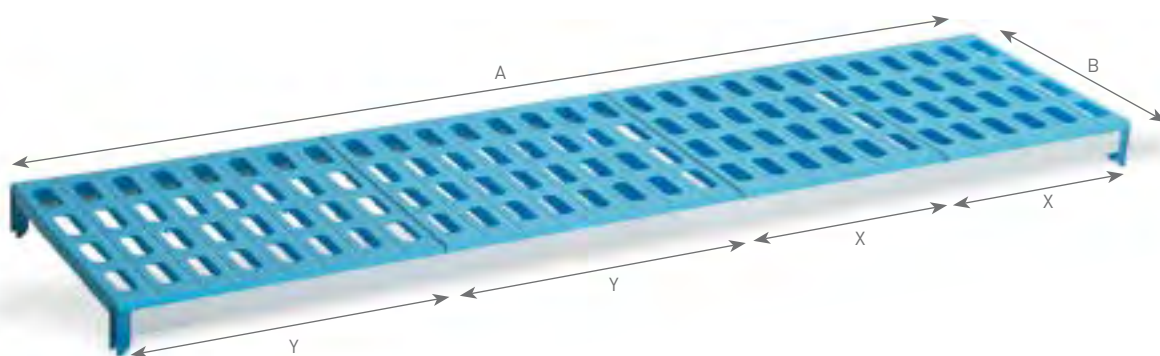

Fondo 555 mm. Adaptable a las cubetas gastronorm 1/1
 Depth 555 mm. Suitable for 1/1 gastronorm containers
 Profondeur 555 mm. Adaptable aux bacs gastronorme 1/1
 Tiefe 555 mm. Passend für Gastronormbehälter 1/1

X significa una parrilla de ancho 325 mm.
 Y significa una parrilla de ancho 435 mm.

X is a rack 325 mm width.
 Y is a rack 435 mm width.

X est une clayette de 325 mm de largeur.
 Y est une clayette de 435 mm de largeur.

X Bezeichnet einen Einlegeboden der Breite von 325 mm.
 Y Bezeichnet einen Gitterboden der Breite von 435 mm.

REF	MOD	COMBINACIÓN / COMBINATION / COMBINAISON / KOMBINATION	A mm	B mm	€
7565	T6	X + X	655	555	38,35
7566	T7	X + Y	770	555	41,90
7567	T8	Y + Y	875	555	45,80
7568	T9	X + X + X	985	555	50,45
7569	T10	Y + X + X	1095	555	56,10
7570	T11	Y + Y + X	1205	555	61,75
7571	T13	Y + Y + Y	1315	555	65,05
7572	T14	Y + X + X + X	1420	555	70,40
7573	T15	Y + Y + X + X	1530	555	74,25
7574	T16	Y + Y + Y + X	1645	555	79,90

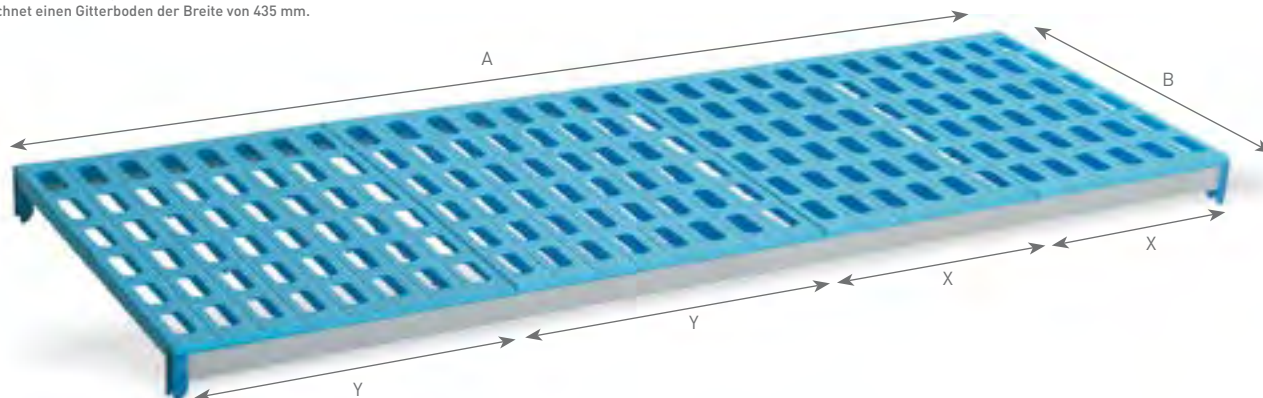

ESTANTES (PARRILLAS + TRAVESAÑOS) / SHELVES (RACK/SHELVES + CROSSBARS) / NIVEAU COMPLET (CLAYETTES + LONGERONS) / REGALE (GITTEBÖDEN + TRAVERSEN)

Soportes laterales / Lateral supports / Support latéraux / Seitliche Ständer

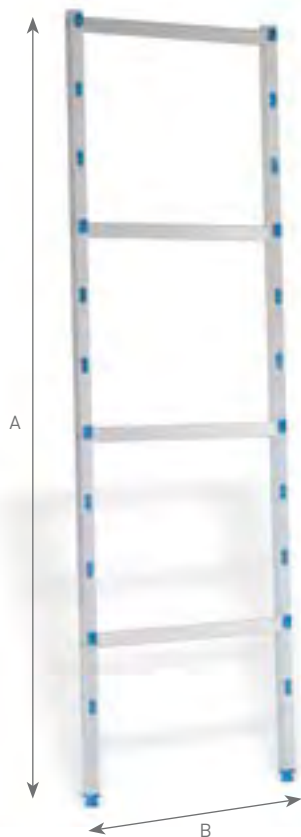

REF	MOD	A mm	B mm	NIVELES/ LEVELS/ NIVEAUX/ EBENEN	€	U
7585	S1	1750	555	3	69,80	1
7586	S2	1750	555	4	72,15	1
7587	S3	1750	555	5	74,65	1
7646	S0	2000	555	4	79,90	1
7588	S4	2000	555	5	91,45	1
7589	S5	2000	555	6	93,85	1
7590	S6	1300	555	3	57,20	1
7591	S7	1750	385	3	63,15	1
7592	S8	1750	385	4	66,15	1
7593	S9	1750	385	5	69,60	1
7647	S13	2000	385	4	78,25	1
7594	S10	2000	385	5	89,00	1
7595	S11	2000	385	6	91,95	1
7596	S12	1300	385	3	54,20	1

2 Fondos disponibles :
555 mm, gastronorm 1/1
385 mm, gastronorm 2/3

2 Available depths:
555 mm, 1/1 gastronorm
385 mm, 2/3 gastronorm

2 profondeurs disponibles:
555 mm, gastronorme 1/1
385 mm, gastronorme 2/3

2 Tiefen erhältlich:
555 mm, Gastronorm 1/1
385 mm, Gastronorm 2/3

Soportes laterales con ruedas / Lateral support with wheels / Supports latéraux avec roues / Seitliche Ständer mit Räder

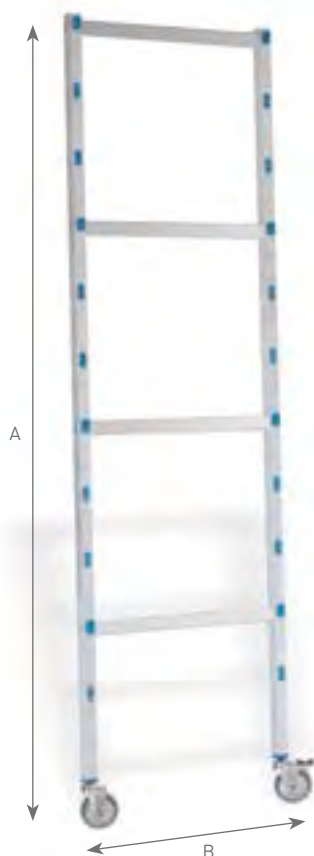

REF	A mm*	B mm	NIVELES/ LEVELS/ NIVEAUX/ EBENEN	€	U
7597	1880	555	3	166,60	1
7598	1880	555	4	183,05	1
7599	1880	555	5	188,20	1
7600	1880	385	3	164,25	1
7601	1880	385	4	178,45	1
7602	1880	385	5	183,25	1

Para montar estanterías móviles con ruedas.
To assembly mobile shelving with wheels.
Pour monter étagères mobiles avec roues.
Für die Montage von mobilen Regalen mit Räder.

* Altura con rueda incluida
* Height including wheel
* Hauteur avec la roue
* Höhe inklusive Räder

Ruedas de Ø 125 mm, dos de ellas con freno.
Wheels Ø 125 mm, two of them with brake.
Roues de Ø 125 mm, deux avec frein.
Räder Ø 125 mm, zwei von ihnen mit Bremsen.

No se recomiendan longitudes de travesaños superiores a 1400 mm.
We do not advise crossbars longer than 1400 mm.
Nous ne conseillons pas des longerons plus longues de 1400 mm.
Wir empfehlen nicht die Länge der Traversen von 1400 mm zu überschreiten.

Travesaños / Crossbars / Longerons / Traversen

REF	L mm	€	U
7632	655	10,35	1
7633	770	11,50	1
7634	875	12,70	1
7635	985	13,45	1
7636	1095	14,20	1
7637	1205	16,25	1
7638	1315	17,15	1
7639	1420	17,80	1
7640	1530	18,15	1
7641	1645	20,15	1



Parrillas / Rack-shelves / Clayettes / Einlegeböden

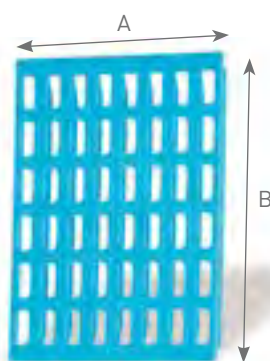

REF	TIPO / TYPE	A mm	B mm	GN Para / For / Pour / Für	€	U
7628	Y	435	555	1/1	10,15	1
7629	X	325	555	1/1	8,70	1
7630	Y	435	385	2/3	8,20	1
7631	X	325	385	2/3	7,45	1

Ganchos para formar ángulos / Hooks to form angles / Crochets pour faire les angles / Haken für Winkelbildung

REF	€	U
7642	4,15	1



Permiten el montaje de los ángulos por lo que se ahorran soportes laterales y se aprovecha al máximo el espacio.
With these hooks it is possible to form angles so you will not need lateral supports and will save the maximum space as possible.
Pour le montage des angles avec un maximum profit de place.
Diese Haken erlauben es Winkel zu montieren ohne den Gebrauch zusätzlicher Seitenständer, um so den maximalen Raum auszunutzen.

Pieza soporte para travesaños / Support for crossbars / Support pour largerons / Halterteil für Traversen

REF	€	U
7643	2,30	1



Esta pieza es necesaria para ampliar el número de niveles estándares en las referencias del catálogo.
This piece is necessary to increase the number of standard levels from the catalogue's references.
Cette pièce est nécessaire pour augmenter le nombre de niveaux standards des références du catalogue.
Dieses Teil ist nötig, um die Standardanzahl der Regalebene, im Katalog aufgelistet, zu erhöhen.

Bancadas / Bench / BanCS / Bänke

Diseñadas para su uso en lugares donde se prohíbe depositar cajas directamente en el suelo. Capacidad de carga de hasta 175 Kg por bancada, repartidos a lo largo de la bancada. Pie regulable para suelos desnivelados.

Designed to be used in places where it is forbidden to put boxes directly on the floor. Maximum load charge 175 Kg per bench, distributed weight throughout the bench. Leveling feet for gradient floors.

Dessinés pour être utilisés quand il est interdit de poser les boîtes directement par terre. Charge maximale 175 Kg, distribués tout au long du banc. Pieds réglateurs pour sols inégaux.

Design für den Gebrauch in Räumen, in denen es verboten ist Kisten direkt auf den Boden zu stellen. Die Tragkraft beträgt bis zu 175 Kg pro Bank, wenn die Last gleichmäßig auf der Länge verteilt ist. Regulierbare Füße für unebene Böden.

REF	A mm	B mm	C mm	€	U
7603	715	555	280	114,90	1
7604	830	555	280	119,05	1
7605	935	555	280	128,10	1
7606	1045	555	280	133,65	1
7607	1155	555	280	137,15	1
7608	1265	555	280	147,30	1
7609	1375	555	280	151,45	1
7610	1480	555	280	160,60	1
7611	715	385	280	112,80	1
7612	830	385	280	117,30	1
7613	935	385	280	122,55	1
7614	1045	385	280	132,70	1
7615	1155	385	280	134,85	1
7616	1260	385	280	145,10	1
7617	1375	385	280	147,40	1
7618	1480	385	280	157,00	1

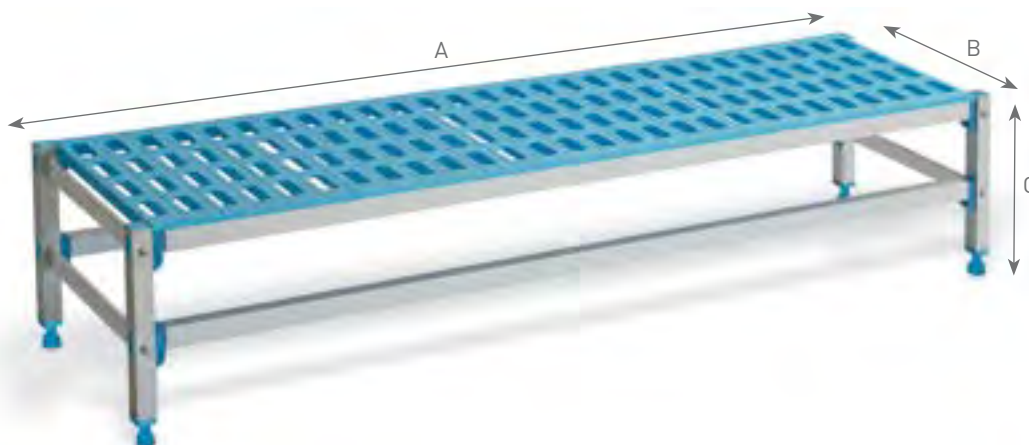

Conjunto completo con ruedas / Complet kits with wheels / Kit préparés avec roues / Komplettes Set mit Rädern



REF	A mm	B mm	C mm	TIPO / TYPE	NIVELES / LEVELS / NIVEAUX / EBENEN	€	U
7143R	935	555	1880	GN 1/1	3	470,95	1
7002R	935	385	1880	GN 2/3	3	451,65	1
7145R	1145	555	1880	GN 1/1	3	501,95	1
7004R	1145	385	1880	GN 2/3	3	474,80	1
7146R	1265	555	1880	GN 1/1	3	518,60	1
7005R	1265	385	1880	GN 2/3	3	487,60	1
7147R	1375	555	1880	GN 1/1	3	528,75	1
7006R	1375	385	1880	GN 2/3	3	538,55	1



Reforzada / Reinforced / Renforcée / Verstärkte

TRANSPORTE Y ALMACENAMIENTO / TRANSPORT & STORAGE / TRANSPORT ET STOCKAGE

3 NIVELES /
LEVELS /
NIVEAUX /
EBENEN

Kits completos / complete kits / Kits préparés/ Komplettssets

Distintas combinaciones /
Diferent combinations /
Diferentes combinaisons /
Verschiedene Kombinationen



Compatible con cubetas 2/3 /
Compatible with 2/3 containers /
Compatible avec bacs 2/3 /
Kombinierbar mit Behältern 2/3

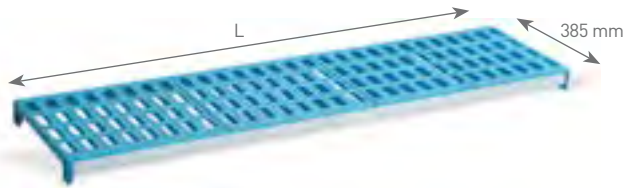

Compatible con cubetas 1/1 /
Compatible with 1/1 containers /
Compatible avec bacs 1/1 /
Kombinierbar mit Behältern 1/1

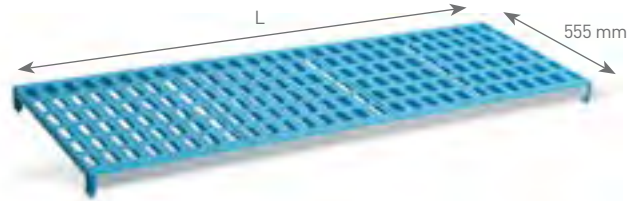

REF	L mm	€	REF	L mm	€
7000	715	229,20	7024	3380	611,20
7001	830	240,40	7025	3513	703,95
7002	935	249,50	7026	3621	716,60
7003	1045	259,60	7027	3729	729,30
7004	1155	272,50	7028	3841	743,60
7005	1265	285,15	7029	3953	757,85
7006	1375	299,40	7030	4065	772,10
7007	1480	311,20	7031	4170	783,80
7008	1590	324,25	7032	4275	795,55
7009	1705	337,25	7033	4380	807,35
7010	1840	435,70	7034	4490	820,25
7011	1950	445,85	7035	4600	833,25
7012	2060	455,95	7036	4710	846,30
7013	2170	469,00	7037	4825	859,30
7014	2280	482,00	7038	4940	872,20
7015	2388	494,60	7039	5055	885,30
7016	2496	507,20	7040	5186	979,95
7017	2608	521,50	7041	5298	994,05
7018	2720	535,80	7042	5410	1.008,45
7019	2825	547,55	7043	5515	1.020,10
7020	2930	559,25	7044	5620	1.031,90
7021	3040	572,25	7045	5725	1.043,60
7022	3150	585,25	7046	5830	1.055,25
7023	3265	598,25			

REF	L mm	€	REF	L mm	€
7141	715	254,75	7165	3380	688,95
7142	830	265,40	7166	3513	801,65
7143	935	277,20	7167	3621	818,30
7144	1045	290,80	7168	3729	834,85
7145	1155	308,20	7169	3841	844,95
7146	1263	324,85	7170	3953	855,10
7147	1375	334,85	7171	4065	865,25
7148	1480	350,75	7172	4170	881,05
7149	1590	362,55	7173	4275	896,95
7150	1705	379,30	7174	4380	912,85
7151	1840	484,45	7175	4490	924,65
7152	1950	498,25	7176	4600	936,35
7153	2060	512,00	7177	4710	948,00
7154	2170	529,25	7178	4825	964,85
7155	2280	546,60	7179	4940	981,55
7156	2388	563,25	7180	5055	998,40
7157	2496	579,80	7181	5186	1.110,05
7158	2608	589,90	7182	5298	1.120,20
7159	2720	600,05	7183	5410	1.130,30
7160	2825	615,95	7184	5515	1.146,20
7161	2930	631,85	7185	5620	1.162,10
7162	3040	643,55	7186	5725	1.177,90
7163	3150	655,30	7187	5830	1.193,85
7164	3265	672,05			

3 NIVELES / LEVELS / NIVEAUX / EBENEN

Estanterías angulares / shelvings for angle / Étagères angulaires / Rechtwinklige Regale

Distintas combinaciones /
Diferent combinations /
Diferentes combinaisons /
Verschiedene Kombinationen



Incluido / Included / Compris / Inklusive:
Ganchos para formar ángulos /
Hooks to form angles /
Crochets pour faire les angles /
Haken für Winkelbildung



Compatible con cubetas 2/3 /
Compatible with 2/3 containers /
Compatible avec bacs 2/3 /
Kombinierbar mit Behältern 2/3

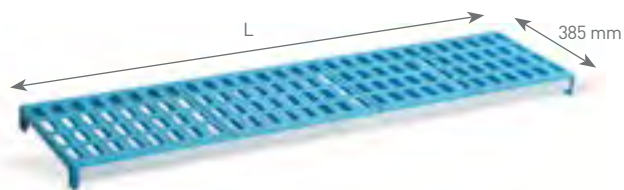

Compatible con cubetas 1/1 /
Compatible with 1/1 containers /
Compatible avec bacs 1/1 /
Kombinierbar mit Behältern 1/1

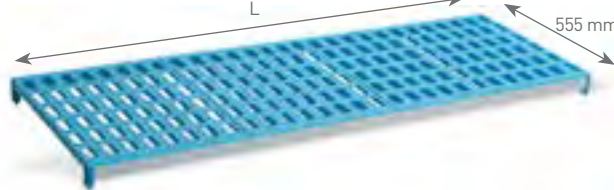

REF	L mm	€	REF	L mm	€
7282	685	191,30	7306	3350	573,35
7283	800	202,60	7307	3483	666,20
7284	905	211,55	7308	3591	678,80
7285	1015	221,55	7309	3699	691,40
7286	1125	234,70	7310	3811	705,65
7287	1233	247,30	7311	3923	719,95
7288	1345	261,60	7312	4035	734,15
7289	1450	273,30	7313	4140	745,95
7290	1560	286,30	7314	4245	757,65
7291	1675	299,30	7315	4350	769,40
7292	1810	397,85	7316	4460	782,40
7293	1920	407,90	7317	4570	795,35
7294	2030	418,05	7318	4680	808,35
7295	2140	431,05	7319	4795	821,25
7296	2250	444,10	7320	4910	834,45
7297	2358	456,65	7321	5025	847,35
7298	2466	469,30	7322	5156	847,35
7299	2578	483,55	7323	5268	956,25
7300	2690	497,85	7324	5380	970,50
7301	2795	509,60	7325	5485	982,20
7302	2900	521,30	7326	5590	993,95
7303	3010	534,30	7327	5695	1.005,65
7304	3120	547,35	7328	5800	1.017,40
7305	3235	560,35			

REF	L mm	€	REF	L mm	€
7423	685	210,25	7447	3350	644,35
7424	800	220,85	7448	3483	757,10
7425	905	232,65	7449	3591	773,75
7426	1015	246,30	7450	3699	790,25
7427	1125	263,65	7451	3811	800,40
7428	1233	280,25	7452	3923	810,55
7429	1345	290,40	7453	4035	820,65
7430	1450	306,20	7454	4140	836,45
7431	1560	318,00	7455	4245	852,40
7432	1675	334,75	7456	4350	868,30
7433	1810	439,95	7457	4460	880,10
7434	1920	453,70	7458	4570	891,75
7435	2030	467,45	7459	4680	903,55
7436	2140	484,85	7460	4795	920,30
7437	2250	502,05	7461	4910	937,15
7438	2358	518,70	7462	5025	953,85
7439	2466	535,20	7463	5156	1.065,60
7440	2578	545,35	7464	5268	1.075,60
7441	2690	555,50	7465	5380	1.085,85
7442	2795	571,40	7466	5485	1.101,65
7443	2900	587,35	7467	5590	1.117,60
7444	3010	599,00	7468	5695	1.133,40
7445	3120	610,80	7469	5800	1.149,40
7446	3235	627,50			

TRANSPORTE Y ALMACENAMIENTO /
TRANSPORT & STORAGE /
TRANSPORT ET STOCKAGE

4 NIVELES /
LEVELS /
NIVEAUX /
EBENEN

Kits completos / Complete kits / Kits préparés / Komplettssets

Distintas combinaciones /
Diferent combinations /
Diferentes combinaisons /
Verschiedene Kombinationen

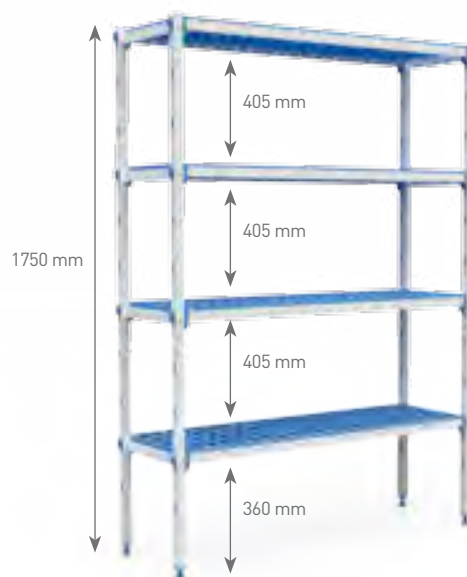

Compatible con cubetas 2/3 /
Compatible with 2/3 containers /
Compatible avec bacs 2/3 /
Kombinierbar mit Behältern 2/3

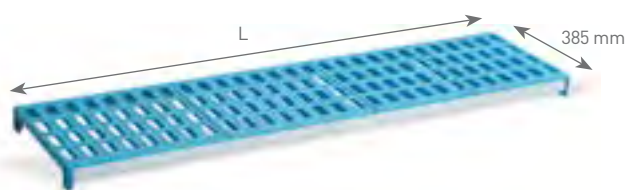

Compatible con cubetas 1/1 /
Compatible with 1/1 containers /
Compatible avec bacs 1/1 /
Kombinierbar mit Behältern 1/1

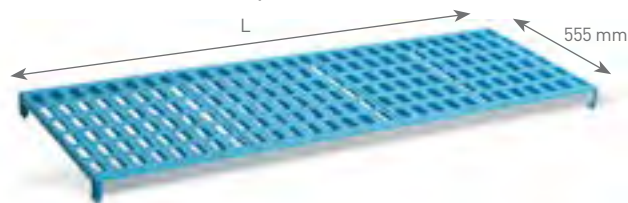

REF	L mm	€	REF	L mm	€
7047	715	269,55	7071	3380	760,85
7048	830	284,55	7072	3513	866,45
7049	935	296,55	7073	3621	883,30
7050	1045	309,95	7074	3729	900,20
7051	1155	327,30	7075	3841	919,25
7052	1263	344,15	7076	3953	938,15
7053	1375	363,20	7077	4065	957,30
7054	1480	378,90	7078	4170	972,90
7055	1590	396,15	7079	4275	988,50
7056	1705	413,50	7080	4380	1.004,20
7057	1840	460,60	7081	4490	1.021,45
7058	1950	540,30	7082	4600	1.038,85
7059	2060	553,85	7083	4710	1.056,20
7060	2170	571,10	7084	4825	1.073,55
7061	2280	599,30	7085	4940	1.090,80
7062	2388	605,30	7086	5055	1.108,15
7063	2496	622,15	7087	5186	1.216,15
7064	2608	641,15	7088	5298	1.235,30
7065	2720	660,25	7089	5410	1.254,30
7066	2825	675,75	7090	5515	1.269,90
7067	2930	691,50	7091	5620	1.285,55
7068	3040	708,85	7092	5725	1.301,25
7069	3150	726,20	7093	5830	1.316,85
7070	3265	743,50			

REF	L mm	€	REF	L mm	€
7188	715	297,95	7212	3380	855,90
7189	830	312,15	7213	3513	985,40
7190	935	327,85	7214	3621	1.007,55
7191	1045	346,10	7215	3729	1.029,70
7192	1155	369,25	7216	3841	1.043,15
7193	1263	391,40	7217	3953	1.056,60
7194	1375	404,80	7218	4065	1.070,15
7195	1480	426,00	7219	4170	1.091,30
7196	1590	441,65	7220	4275	1.112,55
7197	1705	464,00	7221	4380	1.133,70
7198	1840	583,40	7222	4490	1.149,40
7199	1950	601,65	7223	4600	1.164,90
7200	2060	620,00	7224	4710	1.180,60
7201	2170	643,15	7225	4825	1.203,05
7202	2280	666,30	7226	4940	1.225,35
7203	2388	688,35	7227	5055	1.247,70
7204	2496	710,50	7228	5186	1.375,85
7205	2608	724,05	7229	5298	1.389,25
7206	2720	737,50	7230	5410	1.402,85
7207	2825	758,65	7231	5515	1.424,00
7208	2930	779,85	7232	5620	1.445,05
7209	3040	795,45	7233	5725	1.466,25
7210	3150	811,20	7234	5830	1.487,55
7211	3265	833,45			

4 NIVELES /
LEVELS /
NIVEAUX /
EBEBEN

Estanterías angulares / Shelvings for angle / Étagères angulaires / Rechtwinklige Regale

Distintas combinaciones /
Diferent combinations /
Diferentes combinaisons /
Verschiedene Kombinationen



Incluido / Included / Compris / Inklusive:
Ganchos para formar ángulos /
Hooks to form angles /
Crochets pour faire les angles /
Haken für Winkelbildung

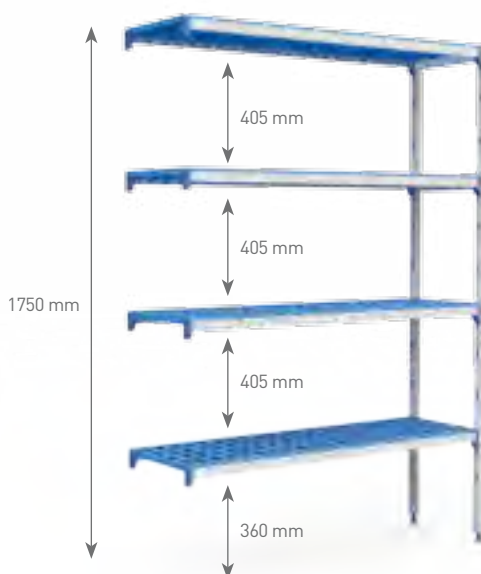

Compatible con cubetas 2/3 /
Compatible with 2/3 containers /
Compatible avec bacs 2/3 /
Kombinierbar mit Behältern 2/3

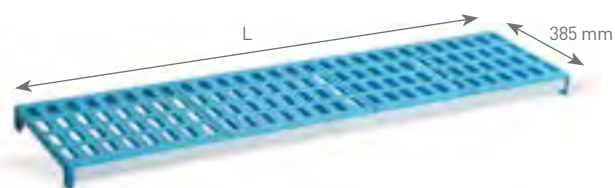

Compatible con cubetas 1/1 /
Compatible with 1/1 containers /
Compatible avec bacs 1/1 /
Kombinierbar mit Behältern 1/1

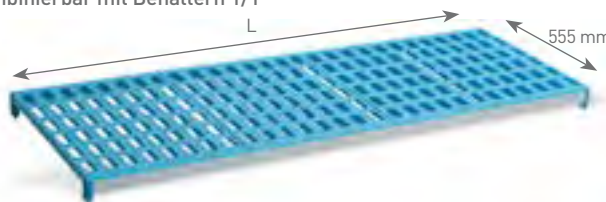

REF	L mm	€	REF	L mm	€
7329	685	228,60	7353	3350	698,90
7330	800	243,60	7354	3483	801,55
7331	905	255,60	7355	3591	817,85
7332	1015	269,05	7356	3699	834,25
7333	1125	286,40	7357	3811	852,70
7334	1233	303,20	7358	3923	871,20
7335	1345	322,25	7359	4035	889,60
7336	1450	337,95	7360	4140	904,80
7337	1560	355,25	7361	4245	947,70
7338	1675	372,60	7362	4350	963,20
7339	1810	485,95	7363	4460	980,55
7340	1920	499,35	7364	4570	997,90
7341	2030	512,95	7365	4680	1.015,30
7342	2140	530,15	7366	4795	1.032,60
7343	2250	547,55	7367	4910	1.049,90
7344	2358	564,50	7368	5025	1.067,25
7345	2466	581,20	7369	5156	1.175,25
7346	2578	600,25	7370	5268	1.194,35
7347	2690	619,35	7371	5380	1.213,25
7348	2795	634,95	7372	5485	1.228,95
7349	2900	650,60	7373	5590	1.244,55
7350	3010	667,90	7374	5695	1.260,30
7351	3120	685,30	7375	5800	1.275,90
7352	3235	693,15			

REF	L mm	€	REF	L mm	€
7470	685	251,05	7494	3350	809,00
7471	800	265,20	7495	3483	938,45
7472	905	280,95	7496	3591	960,60
7473	1015	299,20	7497	3699	982,70
7474	1125	322,25	7498	3811	996,25
7475	1233	344,45	7499	3923	1.009,65
7476	1345	357,90	7500	4035	1.023,25
7477	1450	379,10	7501	4140	1.044,40
7478	1560	394,70	7502	4245	1.065,60
7479	1675	417,10	7503	4350	1.086,80
7480	1810	536,20	7504	4460	1.102,40
7481	1920	554,75	7505	4570	1.118,00
7482	2030	573,05	7506	4680	1.133,70
7483	2140	596,20	7507	4795	1.156,05
7484	2250	619,35	7508	4910	1.178,55
7485	2358	641,50	7509	5025	1.200,75
7486	2466	663,60	7510	5156	1.328,95
7487	2578	677,05	7511	5268	1.342,35
7488	2690	690,55	7512	5380	1.355,80
7489	2795	711,75	7513	5485	1.377,05
7490	2900	731,90	7514	5590	1.398,25
7491	3010	748,55	7515	5695	1.419,45
7492	3120	764,15	7516	5800	1.440,60
7493	3235	786,55			

TRANSPORTE Y ALMACENAMIENTO /
TRANSPORT & STORAGE /
TRANSPORT ET STOCKAGE

ESTANTERÍA COMPLETA / FULL SHELF / ÉTAGÈRE PLEINE

5 NIVELES /
LEVELS /
NIVEAUX /
EBENEN

Kits completos / Complete kits / Kits préparés / Komplettssets

Distintas combinaciones /
Diferent combinations /
Diferentes combinaisons /
Verschiedene Kombinationen



Compatible con cubetas 2/3 /
Compatible with 2/3 containers /
Compatible avec bacs 2/3 /
Kombinierbar mit Behältern 2/3



Compatible con cubetas 1/1 /
Compatible with 1/1 containers /
Compatible avec bacs 1/1 /
Kombinierbar mit Behältern 1/1

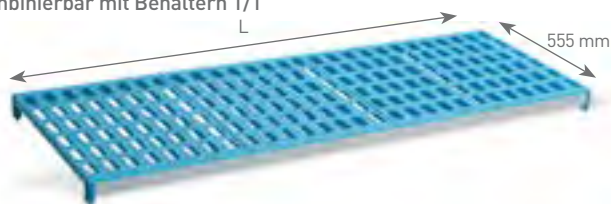

REF	L mm	€	REF	L mm	€
7094	715	309,25	7118	3380	911,70
7095	830	329,40	7119	3513	1.030,70
7096	935	344,45	7120	3621	1.051,75
7097	1045	361,30	7121	3729	1.072,70
7098	1155	382,95	7122	3841	1.096,60
7099	1263	404,00	7123	3953	1.120,30
7100	1375	427,75	7124	4065	1.144,05
7101	1480	447,30	7125	4170	1.163,70
7102	1590	469,00	7126	4275	1.183,20
7103	1705	490,60	7127	4380	1.202,85
7104	1840	619,25	7128	4490	1.224,45
7105	1950	636,10	7129	4600	1.246,15
7106	2060	652,90	7130	4710	1.267,75
7107	2170	674,65	7131	4825	1.289,45
7108	2280	696,20	7132	4940	1.311,15
7109	2388	717,35	7133	5055	1.332,75
7110	2496	738,40	7134	5186	1.454,80
7111	2608	762,15	7135	5298	1.478,45
7112	2720	785,95	7136	5410	1.502,35
7113	2825	805,45	7137	5515	1.521,75
7114	2930	825,00	7138	5620	1.541,40
7115	3040	846,70	7139	5725	1.560,95
7116	3150	868,40	7140	5830	1.580,45
7117	3265	890,00			

REF	L mm	€	REF	L mm	€
7235	715	341,15	7259	3380	1.022,95
7236	830	358,90	7260	3513	1.169,25
7237	935	378,45	7261	3621	1.196,85
7238	1045	401,40	7262	3729	1.224,55
7239	1155	430,25	7263	3841	1.241,35
7240	1263	457,95	7264	3953	1.258,25
7241	1375	474,80	7265	4065	1.275,05
7242	1480	501,25	7266	4170	1.301,65
7243	1590	520,80	7267	4275	1.328,10
7244	1705	548,80	7268	4380	1.354,55
7245	1840	682,40	7269	4490	1.374,05
7246	1950	705,25	7270	4600	1.393,60
7247	2060	728,10	7271	4710	1.413,25
7248	2170	757,00	7272	4825	1.441,25
7249	2280	785,85	7273	4940	1.469,15
7250	2388	813,50	7274	5055	1.497,20
7251	2496	841,20	7275	5186	1.641,50
7252	2608	858,10	7276	5298	1.658,40
7253	2720	874,95	7277	5410	1.675,20
7254	2825	901,40	7278	5515	1.701,80
7255	2930	927,95	7279	5620	1.728,25
7256	3040	947,50	7280	5725	1.754,70
7257	3150	967,00	7281	5830	1.781,15
7258	3265	994,95			

5 NIVELES / LEVELS / NIVEAUX / EBENEN

Estanterías angulares / Shelvings for angle / Étagères angulaires / Rechtwinklige Regale

Distintas combinaciones / Different combinations / Diferentes combinaisons / Verschiedene Kombinationen



Incluido / Included / Compris / Inklusive:
Ganchos para formar ángulos / Hooks to form angles / Crochets pour faire les angles / Haken für Winkelbildung



Compatible con cubetas 2/3 / Compatible with 2/3 containers / Compatible avec bacs 2/3 / Kombinierbar mit Behältern 2/3

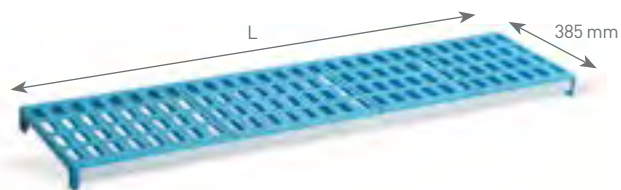

Compatible con cubetas 1/1 / Compatible with 1/1 containers / Compatible avec bacs 1/1 / Kombinierbar mit Behältern 1/1

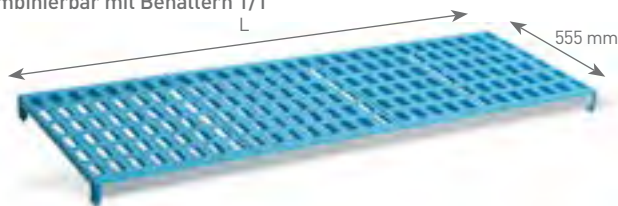

REF	L mm	€	REF	L mm	€
7376	685	266,35	7400	3350	867,30
7377	800	285,05	7401	3483	986,30
7378	905	300,10	7402	3591	1.007,30
7379	1015	316,90	7403	3699	1.028,40
7380	1125	338,55	7404	3811	1.052,25
7381	1233	359,65	7405	3923	1.075,90
7382	1345	383,45	7406	4035	1.099,70
7383	1450	402,95	7407	4140	1.119,20
7384	1560	424,65	7408	4245	1.138,85
7385	1675	446,25	7409	4350	1.158,50
7386	1810	574,95	7410	4460	1.180,10
7387	1920	591,75	7411	4570	1.201,80
7388	2030	608,60	7412	4680	1.223,40
7389	2140	630,35	7413	4795	1.245,10
7390	2250	651,90	7414	4910	1.266,80
7391	2358	673,00	7415	5025	1.288,40
7392	2466	694,10	7416	5156	1.410,30
7393	2578	717,85	7417	5268	1.434,15
7394	2690	741,60	7418	5380	1.457,90
7395	2795	761,15	7419	5485	1.477,45
7396	2900	780,70	7420	5590	1.496,95
7397	3010	802,40	7421	5695	1.516,60
7398	3120	824,00	7422	5800	1.536,15
7399	3235	845,70			

REF	L mm	€	REF	L mm	€
7517	685	291,85	7541	3350	973,60
7518	800	309,55	7542	3483	1.119,85
7519	905	329,20	7543	3591	1.147,55
7520	1015	352,00	7544	3699	1.175,15
7521	1125	380,85	7545	3811	1.192,00
7522	1233	408,55	7546	3923	1.208,80
7523	1345	425,35	7547	4035	1.225,65
7524	1450	451,85	7548	4140	1.252,20
7525	1560	471,45	7549	4245	1.278,70
7526	1675	499,35	7550	4350	1.305,15
7527	1810	633,00	7551	4460	1.324,70
7528	1920	655,85	7552	4570	1.344,35
7529	2030	678,80	7553	4680	1.363,85
7530	2140	707,60	7554	4795	1.391,75
7531	2250	736,55	7555	4910	1.419,75
7532	2358	764,15	7556	5025	1.447,85
7533	2466	791,85	7557	5156	1.592,25
7534	2578	808,70	7558	5268	1.609,15
7535	2690	825,60	7559	5380	1.625,90
7536	2795	852,10	7560	5485	1.652,45
7537	2900	878,55	7561	5590	1.678,95
7538	3010	897,75	7562	5695	1.705,40
7539	3120	917,70	7563	5800	1.731,85
7540	3235	945,60			

TRANSPORTE Y ALMACENAMIENTO / TRANSPORT & STORAGE / TRANSPORT ET STOCKAGE

DESGLOSE CONJUNTOS DE ESTANTERÍAS / BREAKDOWN OF SHELVING SETS / SETS DES ÉTAGÈRES / AUFLISTUNGSÜBERSICHT DER REGALSETS

FONDO 385 mm. Adaptable a GASTRONORM 2/3 / DEEPH 385 mm. Suitable for 2/3 GASTRONORM / PROFONDEUR 385 mm. Adaptable aux GASTRONORME 2/3 / Tiefe 385 mm. Passend für Gastronorm 2/3

REF. 3 niveles 3 levels 3 niveaux 3 Ebenen	DESGLOSE BREAKDOWN COMPOSITION AUFLISTUNG	REF. 4 niveles 4 levels 4 niveaux 4 Ebenen	DESGLOSE BREAKDOWN COMPOSITION AUFLISTUNG	REF. 5 niveles 5 levels 5 niveaux 5 Ebenen	DESGLOSE BREAKDOWN COMPOSITION AUFLISTUNG
7000	2 S7 + 3 T61	7047	2 S8 + 4 T61	7094	2 S9 + 5 T61
7001	2 S7 + 3 T71	7048	2 S8 + 4 T71	7095	2 S9 + 5 T71
7002	2 S7 + 3 T81	7049	2 S8 + 4 T81	7096	2 S9 + 5 T81
7003	2 S7 + 3 T91	7050	2 S8 + 4 T91	7097	2 S9 + 5 T91
7004	2 S7 + 3 T101	7051	2 S8 + 4 T10	7098	2 S9 + 5 T101
7005	2 S7 + 3 T111	7052	2 S8 + 4 T111	7099	2 S9 + 5 T111
7006	2 S7 + 3 T131	7053	2 S8 + 4 T131	7100	2 S9 + 5 T131
7007	2 S7 + 3 T141	7054	2 S8 + 4 T141	7101	2 S9 + 5 T141
7008	2 S7 + 3 T151	7055	2 S8 + 4 T151	7102	2 S9 + 5 T151
7009	2 S7 + 3 T161	7056	2 S8 + 4 T161	7103	2 S9 + 5 T161
7010	3 S7 + 6 T81	7057	3 S8 + 8 T81	7104	3 S9 + 10 T81
7011	3 S7 + 3 T81 + 3 T91	7058	3 S8 + 4 T81 + 4 T91	7105	3 S9 + 5 T81 + 5 T91
7012	3 S7 + 6 T91	7059	3 S8 + 8 T91	7106	3 S9 + 10 T91
7013	3 S7 + 3 T91 + 3 T101	7060	3 S8 + 4 T91 + 4 T101	7107	3 S9 + 5 T91 + 5 T101
7014	3 S7 + 6 T101	7061	3 S8 + 8 T101	7108	3 S9 + 10 T101
7015	3 S7 + 3 T101 + 3 T111	7062	3 S8 + 4 T101 + 4 T111	7109	3 S9 + 5 T101 + 5 T111
7016	3 S7 + 6 T111	7063	3 S8 + 8 T111	7110	3 S9 + 10 T111
7017	3 S7 + 3 T111 + 3 T131	7064	3 S8 + 4 T111 + 4 T131	7111	3 S9 + 5 T111 + 5 T131
7018	3 S7 + 6 T131	7065	3 S8 + 8 T131	7112	3 S9 + 10 T131
7019	3 S7 + 3 T131 + 3 T141	7066	3 S8 + 4 T131 + 4 T141	7113	3 S9 + 5 T131 + 5 T141
7020	3 S7 + 6 T141	7067	3 S8 + 8 T141	7114	3 S9 + 10 T141
7021	3 S7 + 3 T141 + 3 T151	7068	3 S8 + 4 T141 + 4 T151	7115	3 S9 + 5 T141 + 5 T151
7022	3 S7 + 6 T151	7069	3 S8 + 8 T151	7116	3 S9 + 10 T151
7023	3 S7 + 3 T151 + 3 T161	7070	3 S8 + 4 T151 + 4 T161	7117	3 S9 + 5 T151 + 5 T161
7024	3 S7 + 6 T161	7071	3 S8 + 8 T161	7118	3 S9 + 10 T161
7025	4 S7 + 6 T101 + 3 T111	7072	4 S8 + 8 T101 + 4 T111	7119	4 S9 + 10 T101 + 5 T111
7026	4 S7 + 3 T101 + 6 T111	7073	4 S8 + 4 T101 + 8 T111	7120	4 S9 + 5 T101 + 10 T111
7027	4 S7 + 9 T111	7074	4 S8 + 12 T111	7121	4 S9 + 15 T111
7028	4 S7 + 6 T111 + 3 T131	7075	4 S8 + 8 T111 + 4 T131	7122	4 S9 + 10 T111 + 5 T131
7029	4 S7 + 3 T111 + 6 T131	7076	4 S8 + 4 T111 + 8 T131	7123	4 S9 + 5 T111 + 10 T131
7030	4 S7 + 9 T131	7077	4 S8 + 12 T131	7124	4 S9 + 15 T131
7031	4 S7 + 6 T131 + 3 T141	7078	4 S8 + 8 T131 + 4 T141	7125	4 S9 + 10 T131 + 5 T141
7032	4 S7 + 3 T131 + 6 T141	7079	4 S8 + 4 T131 + 8 T141	7126	4 S9 + 5 T131 + 10 T141
7033	4 S7 + 9 T141	7080	4 S8 + 12 T141	7127	4 S9 + 15 T141
7034	4 S7 + 6 T141 + 3 T151	7081	4 S8 + 8 T141 + 4 T151	7128	4 S9 + 10 T141 + 5 T151
7035	4 S7 + 3 T141 + 6 T151	7082	4 S8 + 4 T141 + 8 T151	7129	4 S9 + 5 T141 + 10 T151
7036	4 S7 + 9 T151	7083	4 S8 + 12 T151	7130	4 S9 + 15 T151
7037	4 S7 + 6 T151 + 3 T161	7084	4 S8 + 8 T151 + 4 T161	7131	4 S9 + 10 T151 + 5 T161
7038	4 S7 + 3 T151 + 6 T161	7085	4 S8 + 4 T151 + 8 T161	7132	4 S9 + 5 T151 + 10 T161
7039	4 S7 + 9 T161	7086	4 S8 + 12 T161	7133	4 S9 + 15 T161
7040	5 S7 + 6 T111 + 6 T131	7087	5 S8 + 8 T111 + 8 T131	7134	5 S9 + 10 T111 + 10 T131
7041	5 S7 + 3 T111 + 9 T131	7088	5 S8 + 4 T111 + 12 T131	7135	5 S9 + 5 T111 + 15 T131
7042	5 S7 + 12 T131	7089	5 S8 + 16 T131	7136	5 S9 + 20 T131
7043	5 S7 + 3 T141 + 9 T131	7090	5 S8 + 4 T141 + 12 T131	7137	5 S9 + 5 T141 + 15 T131
7044	5 S7 + 6 T131 + 6 T141	7091	5 S8 + 8 T131 + 8 T141	7138	5 S9 + 10 T131 + 10 T141
7045	5 S7 + 3 T131 + 9 T141	7092	5 S8 + 4 T131 + 12 T141	7139	5 S9 + 5 T131 + 15 T141
7046	5 S7 + 12 T141	7093	5 S8 + 16 T141	7140	5 S9 + 20 T141

DESGLASE CONJUNTOS DE ESTANTERÍAS / BREAKDOWN OF SHELVING SETS / SETS DES ÉTAGÈRES / AUFLISTUNGSÜBERSICHT DER REGALSETS

FONDO 555 mm. Adaptable a GASTRONORM 1/1 / DEEPH 555 mm. Suitable for 1/1 GASTRONORM / PROFONDEUR 555 mm. Adaptable aux GASTRONORME 1/1 / Tiefe 555 mm. Passend für Gastronorm 1/1

REF. 3 niveles 3 niveaux 3 Ebenen	DESGLASE BREAKDOWN COMPOSITION AUFLISTUNG
7141	2 S1 + 3 T6
7142	2 S1 + 3 T7
7143	2 S1 + 3 T8
7144	2 S1 + 3 T9
7145	2 S1 + 3 T10
7146	2 S1 + 3 T11
7147	2 S1 + 3 T13
7148	2 S1 + 3 T14
7149	2 S1 + 3 T15
7150	2 S1 + 3 T16
7151	3 S1 + 6 T8
7152	3 S1 + 3 T8 + 3 T9
7153	3 S1 + 6 T9
7154	3 S1 + 3 T9 + 3 T10
7155	3 S1 + 6 T10
7156	3 S1 + 3 T10 + 3 T11
7157	3 S1 + 6 T11
7158	3 S1 + 3 T11 + 3 T13
7159	3 S1 + 6 T13
7160	3 S1 + 3 T13 + 3 T14
7161	3 S1 + 6 T14
7162	3 S1 + 3 T14 + 3 T15
7163	3 S1 + 6 T15
7164	3 S1 + 3 T15 + 3 T16
7165	3 S1 + 6 T16
7166	4 S1 + 6 T10 + 3 T11
7167	4 S1 + 3 T10 + 6 T11
7168	4 S1 + 9 T11
7169	4 S1 + 6 T11 + 3 T13
7170	4 S1 + 3 T11 + 6 T13
7171	4 S1 + 9 T13
7172	4 S1 + 6 T13 + 3 T14
7173	4 S1 + 3 T13 + 6 T14
7174	4 S1 + 9 T14
7175	4 S1 + 6 T14 + 3 T15
7176	4 S1 + 3 T14 + 6 T15
7177	4 S1 + 9 T15
7178	4 S1 + 6 T15 + 3 T16
7179	4 S1 + 3 T15 + 6 T16
7180	4 S1 + 9 T16
7181	5 S1 + 6 T11 + 6 T13
7182	5 S1 + 3 T11 + 9 T13
7183	5 S1 + 12 T13
7184	5 S1 + 3 T14 + 9 T13
7185	5 S1 + 6 T13 + 6 T14
7186	5 S1 + 3 T13 + 9 T14
7187	5 S1 + 12 T14

REF. 4 niveles 4 levels 4 niveaux 4 Ebenen	DESGLASE BREAKDOWN COMPOSITION AUFLISTUNG
7188	2 S2 + 4 T6
7189	2 S2 + 4 T7
7190	2 S2 + 4 T8
7191	2 S2 + 4 T9
7192	2 S2 + 4 T10
7193	2 S2 + 4 T11
7194	2 S2 + 4 T13
7195	2 S2 + 4 T14
7196	2 S2 + 4 T15
7197	2 S2 + 4 T16
7198	3 S2 + 8 T8
7199	3 S2 + 4 T8 + 4 T9
7200	3 S2 + 8 T9
7201	3 S2 + 4 T9 + 4 T10
7202	3 S2 + 8 T10
7203	3 S2 + 4 T10 + 4 T11
7204	3 S2 + 8 T11
7205	3 S2 + 4 T11 + 4 T13
7206	3 S2 + 8 T13
7207	3 S2 + 4 T13 + 4 T14
7208	3 S2 + 8 T14
7209	3 S2 + 4 T14 + 4 T15
7210	3 S2 + 8 T15
7211	3 S2 + 4 T15 + 4 T16
7212	3 S2 + 8 T16
7213	4 S2 + 8 T10 + 4 T11
7214	4 S2 + 4 T10 + 8 T11
7215	4 S2 + 12 T11
7216	4 S2 + 8 T11 + 4 T13
7217	4 S2 + 4 T11 + 8 T13
7218	4 S2 + 12 T13
7219	4 S2 + 8 T13 + 4 T14
7220	4 S2 + 4 T13 + 8 T14
7221	4 S2 + 12 T14
7222	4 S2 + 8 T14 + 4 T15
7223	4 S2 + 4 T14 + 8 T15
7224	4 S2 + 12 T15
7225	4 S2 + 8 T15 + 4 T16
7226	4 S2 + 4 T15 + 8 T16
7227	4 S2 + 12 T16
7228	5 S2 + 8 T11 + 8 T13
7229	5 S2 + 4 T11 + 12 T13
7230	5 S2 + 16 T13
7231	5 S2 + 4 T14 + 12 T13
7232	5 S2 + 8 T13 + 8 T14
7233	5 S2 + 4 T13 + 12 T14
7234	5 S2 + 16 T14

REF. 5 niveles 5 levels 5 niveaux 5 Ebenen	DESGLASE BREAKDOWN COMPOSITION AUFLISTUNG
7235	2 S3 + 5 T6
7236	2 S3 + 5 T7
7237	2 S3 + 5 T8
7238	2 S3 + 5 T9
7239	2 S3 + 5 T10
7240	2 S3 + 5 T11
7241	2 S3 + 5 T13
7242	2 S3 + 5 T14
7243	2 S3 + 5 T15
7244	2 S3 + 5 T16
7245	3 S3 + 10 T8
7246	3 S3 + 5 T8 + 5 T9
7247	3 S3 + 10 T9
7248	3 S3 + 5 T9 + 5 T10
7249	3 S3 + 10 T10
7250	3 S3 + 5 T10 + 5 T11
7251	3 S3 + 10 T11
7252	3 S3 + 5 T11 + 5 T13
7253	3 S3 + 10 T13
7254	3 S3 + 5 T13 + 5 T14
7255	3 S3 + 10 T14
7256	3 S3 + 5 T14 + 5 T15
7257	3 S3 + 10 T15
7258	3 S3 + 5 T15 + 5 T16
7259	3 S3 + 10 T16
7260	4 S3 + 10 T10 + 5 T11
7261	4 S3 + 5 T10 + 10 T11
7262	4 S3 + 15 T11
7263	4 S3 + 10 T11 + 5 T13
7264	4 S3 + 5 T11 + 10 T13
7265	4 S3 + 15 T13
7266	4 S3 + 10 T13 + 5 T14
7267	4 S3 + 5 T13 + 10 T14
7268	4 S3 + 15 T14
7269	4 S3 + 10 T14 + 5 T15
7270	4 S3 + 5 T14 + 10 T15
7271	4 S3 + 15 T15
7272	4 S3 + 10 T15 + 5 T16
7273	4 S3 + 5 T15 + 10 T16
7274	4 S3 + 15 T16
7275	5 S3 + 10 T11 + 10 T13
7276	5 S3 + 5 T11 + 15 T13
7277	5 S3 + 20 T13
7278	5 S3 + 5 T14 + 15 T13
7279	5 S3 + 10 T13 + 10 T14
7280	5 S3 + 5 T13 + 15 T14
7281	5 S3 + 20 T14

DESGLOSE CONJUNTOS DE ESTANTERÍAS / BREAKDOWN OF SHELVING SETS / SETS DES ÉTAGÈRES / AUFLISTUNGSÜBERSICHT DER REGALSETS

FONDO 385 mm. Adaptable a GASTRONORM 2/3 / DEEPH 385 mm. Suitable for 2/3 GASTRONORM / PROFONDEUR 385 mm. Adaptable aux GASTRONORME 2/3 / Tiefe 385 mm. Passend für Gastronorm 2/3

REF. 3 niveles 3 levels 3 niveaux 3 Ebenen	DESGLOSE BREAKDOWN COMPOSITION AUFLISTUNG	REF. 4 niveles 4 levels 4 niveaux 4 Ebenen	DESGLOSE BREAKDOWN COMPOSITION AUFLISTUNG	REF. 5 niveles 5 levels 5 niveaux 5 Ebenen	DESGLOSE BREAKDOWN COMPOSITION AUFLISTUNG
7282	1 S7 + 3 T61	7329	1 S8 + 4 T61	7376	1 S9 + 5 T61
7283	1 S7 + 3 T71	7330	1 S8 + 4 T71	7377	1 S9 + 5 T71
7284	1 S7 + 3 T81	7331	1 S8 + 4 T81	7378	1 S9 + 5 T81
7285	1 S7 + 3 T91	7332	1 S8 + 4 T91	7379	1 S9 + 5 T91
7286	1 S7 + 3 T101	7333	1 S8 + 4 T101	7380	1 S9 + 5 T101
7287	1 S7 + 3 T111	7334	1 S8 + 4 T111	7381	1 S9 + 5 T111
7288	1 S7 + 3 T131	7335	1 S8 + 4 T131	7382	1 S9 + 5 T131
7289	1 S7 + 3 T141	7336	1 S8 + 4 T141	7383	1 S9 + 5 T141
7290	1 S7 + 3 T151	7337	1 S8 + 4 T151	7384	1 S9 + 5 T151
7291	1 S7 + 3 T161	7338	1 S8 + 4 T161	7385	1 S9 + 5 T161
7292	2 S7 + 6 T81	7339	2 S8 + 8 T81	7386	2 S9 + 10 T81
7293	2 S7 + 3 T81 + 3 T91	7340	2 S8 + 4 T81 + 4 T91	7387	2 S9 + 5 T81 + 5 T91
7294	2 S7 + 6 T91	7341	2 S8 + 8 T91	7388	2 S9 + 10 T91
7295	2 S7 + 3 T91 + 3 T101	7342	2 S8 + 4 T91 + 4 T101	7389	2 S9 + 5 T91 + 5 T101
7296	2 S7 + 6 T101	7343	2 S8 + 8 T101	7390	2 S9 + 10 T101
7297	2 S7 + 3 T111 + 3 T111	7344	2 S8 + 4 T101 + 4 T111	7391	2 S9 + 5 T101 + 5 T111
7298	2 S7 + 6 T111	7345	2 S8 + 8 T111	7392	2 S9 + 10 T111
7299	2 S7 + 3 T111 + 3 T131	7346	2 S8 + 4 T111 + 4 T131	7393	2 S9 + 5 T111 + 5 T131
7300	2 S7 + 6 T131	7347	2 S8 + 8 T131	7394	2 S9 + 10 T131
7301	2 S7 + 3 T131 + 3 T141	7348	2 S8 + 4 T131 + 4 T141	7395	2 S9 + 5 T131 + 5 T141
7302	2 S7 + 6 T141	7349	2 S8 + 8 T141	7396	2 S9 + 10 T141
7303	2 S7 + 3 T141 + 3 T151	7350	2 S8 + 4 T141 + 4 T151	7397	2 S9 + 5 T141 + 5 T151
7304	2 S7 + 6 T151	7351	2 S8 + 6 T151	7398	2 S9 + 10 T151
7305	2 S7 + 3 T151 + 3 T161	7352	2 S8 + 4 T151 + 4 T161	7399	2 S9 + 5 T151 + 5 T161
7306	2 S7 + 6 T161	7353	2 S8 + 8 T161	7400	2 S9 + 10 T161
7307	3 S7 + 6 T101 + 3 T111	7354	3 S8 + 8 T101 + 4 T111	7401	3 S9 + 10 T101 + 5 T111
7308	3 S7 + 3 T101 + 6 T111	7355	3 S8 + 4 T101 + 8 T111	7402	3 S9 + 5 T101 + 10 T111
7309	3 S7 + 9 T111	7356	3 S8 + 12 T111	7403	3 S9 + 15 T111
7310	3 S7 + 6 T111 + 3 T131	7357	3 S8 + 8 T111 + 4 T131	7404	3 S9 + 10 T111 + 5 T131
7311	3 S7 + 3 T111 + 6 T131	7358	3 S8 + 4 T111 + 8 T131	7405	3 S9 + 5 T111 + 10 T131
7312	3 S7 + 9 T131	7359	3 S8 + 12 T131	7406	3 S9 + 15 T131
7313	3 S7 + 6 T131 + 3 T141	7360	3 S8 + 8 T131 + 4 T141	7407	3 S9 + 10 T131 + 5 T141
7314	3 S7 + 3 T131 + 6 T141	7361	3 S8 + 4 T131 + 8 T141	7408	3 S9 + 5 T131 + 10 T141
7315	3 S7 + 9 T141	7362	3 S8 + 12 T141	7409	3 S9 + 15 T141
7316	3 S7 + 6 T141 + 3 T151	7363	3 S8 + 8 T141 + 4 T151	7410	3 S9 + 10 T141 + 5 T151
7317	3 S7 + 3 T141 + 6 T151	7364	3 S8 + 4 T141 + 8 T151	7411	3 S9 + 5 T141 + 10 T151
7318	3 S7 + 9 T151	7365	3 S8 + 12 T151	7412	3 S9 + 15 T151
7319	3 S7 + 6 T151 + 3 T161	7366	3 S8 + 8 T151 + 4 T161	7413	3 S9 + 10 T151 + 5 T161
7320	3 S7 + 3 T151 + 6 T161	7367	3 S8 + 4 T151 + 8 T161	7414	3 S9 + 5 T151 + 10 T161
7321	3 S7 + 9 T161	7368	3 S8 + 12 T161	7415	3 S9 + 15 T161
7322	4 S7 + 6 T111 + 6 T131	7369	4 S8 + 8 T111 + 8 T131	7416	4 S9 + 10 T111 + 10 T131
7323	4 S7 + 3 T111 + 9 T131	7370	4 S8 + 4 T111 + 12 T131	7417	4 S9 + 5 T111 + 15 T131
7324	4 S7 + 12 T131	7371	4 S8 + 16 T131	7418	4 S9 + 20 T131
7325	4 S7 + 3 T141 + 9 T131	7372	4 S8 + 4 T141 + 12 T131	7419	4 S9 + 5 T141 + 15 T131
7326	4 S7 + 6 T131 + 6 T141	7373	4 S8 + 8 T131 + 8 T141	7420	4 S9 + 10 T131 + 10 T141
7327	4 S7 + 3 T131 + 9 T141	7374	4 S8 + 4 T131 + 12 T141	7421	4 S9 + 5 T131 + 15 T141
7328	4 S7 + 12 T141	7375	4 S8 + 16 T141	7422	4 S9 + 20 T141

DESGLOSE CONJUNTOS DE ESTANTERÍAS / BREAKDOWN OF SHELVING SETS / SETS DES ÉTAGÈRES / AUFLISTUNGSÜBERSICHT DER REGALSETS

FONDO 555 mm. Adaptable a GASTRONORM 1/1 / DEEPH 555 mm. Suitable for 1/1 GASTRONORM / PROFONDEUR 555 mm. Adaptable aux GASTRONORME 1/1 / Tiefe 555 mm. Passend für Gastronorm 1/1

REF. 3 niveles 3 levels 3 niveaux 3 Ebenen	DESGLOSE BREAKDOWN COMPOSITION AUFLISTUNG	REF. 4 niveles 4 levels 4 niveaux 4 Ebenen	DESGLOSE BREAKDOWN COMPOSITION AUFLISTUNG	REF. 5 niveles 5 levels 5 niveaux 5 Ebenen	DESGLOSE BREAKDOWN COMPOSITION AUFLISTUNG
7423	1 S1 + 3 T6	7470	1 S2 + 4 T6	7517	1 S3 + 5 T6
7424	1 S1 + 3 T7	7471	1 S2 + 4 T7	7518	1 S3 + 5 T7
7425	1 S1 + 3 T8	7472	1 S2 + 4 T8	7519	1 S3 + 5 T8
7426	1 S1 + 3 T9	7473	1 S2 + 4 T9	7520	1 S3 + 5 T9
7427	1 S1 + 3 T10	7474	1 S2 + 4 T10	7521	1 S3 + 5 T10
7428	1 S1 + 3 T11	7475	1 S2 + 4 T11	7522	1 S3 + 5 T11
7429	1 S1 + 3 T13	7476	1 S2 + 4 T13	7523	1 S3 + 5 T13
7430	1 S1 + 3 T14	7477	1 S2 + 4 T14	7524	1 S3 + 5 T14
7431	1 S1 + 3 T15	7478	1 S2 + 4 T15	7525	1 S3 + 5 T15
7432	1 S1 + 3 T16	7479	1 S2 + 4 T16	7526	1 S3 + 5 T16
7433	2 S1 + 6 T8	7480	2 S2 + 8 T8	7527	2 S3 + 10 T8
7434	2 S1 + 3 T8 + 3 T9	7481	2 S2 + 4 T8 + 4 T9	7528	2 S3 + 5 T8 + 5 T9
7435	2 S1 + 6 T9	7482	2 S2 + 8 T9	7529	2 S3 + 10 T9
7436	2 S1 + 3 T9 + 3 T10	7483	2 S2 + 4 T9 + 4 T10	7530	2 S3 + 5 T9 + 5 T10
7437	2 S1 + 6 T10	7484	2 S2 + 8 T10	7531	2 S3 + 10 T10
7438	2 S1 + 3 T10 + 3 T11	7485	2 S2 + 4 T10 + 4 T11	7532	2 S3 + 5 T10 + 5 T11
7439	2 S1 + 6 T11	7486	2 S2 + 8 T11	7533	2 S3 + 10 T11
7440	2 S1 + 3 T11 + 3 T13	7487	2 S2 + 4 T11 + 4 T13	7534	2 S3 + 5 T11 + 5 T13
7441	2 S1 + 6 T13	7488	2 S2 + 8 T13	7535	2 S3 + 10 T13
7442	2 S1 + 3 T13 + 3 T14	7489	2 S2 + 4 T13 + 4 T14	7536	2 S3 + 5 T13 + 5 T14
7443	2 S1 + 6 T14	7490	2 S2 + 8 T14	7537	2 S3 + 10 T14
7444	2 S1 + 3 T14 + 3 T15	7491	2 S2 + 4 T14 + 4 T15	7538	2 S3 + 5 T14 + 5 T15
7445	2 S1 + 6 T15	7492	2 S2 + 6 T15	7539	2 S3 + 10 T15
7446	2 S1 + 3 T15 + 3 T16	7493	2 S2 + 4 T15 + 4 T16	7540	2 S3 + 5 T15 + 5 T16
7447	2 S1 + 6 T16	7494	2 S2 + 8 T16	7541	2 S3 + 10 T16
7448	3 S1 + 6 T10 + 3 T11	7495	3 S2 + 8 T10 + 4 T11	7542	3 S3 + 10 T10 + 5 T11
7449	3 S1 + 3 T10 + 6 T11	7496	3 S2 + 4 T10 + 8 T11	7543	3 S3 + 5 T10 + 10 T11
7450	3 S1 + 9 T11	7497	3 S2 + 12 T11	7544	3 S3 + 15 T11
7451	3 S1 + 6 T11 + 3 T13	7498	3 S2 + 8 T11 + 4 T13	7545	3 S3 + 10 T11 + 5 T13
7452	3 S1 + 3 T11 + 6 T13	7499	3 S2 + 4 T11 + 8 T13	7546	3 S3 + 5 T11 + 10 T13
7453	3 S1 + 9 T13	7500	3 S2 + 12 T13	7547	3 S3 + 15 T13
7454	3 S1 + 6 T13 + 3 T14	7501	3 S2 + 8 T13 + 4 T14	7548	3 S3 + 10 T13 + 5 T14
7455	3 S1 + 3 T13 + 6 T14	7502	3 S2 + 4 T13 + 8 T14	7549	3 S3 + 5 T13 + 10 T14
7456	3 S1 + 9 T14	7503	3 S2 + 12 T14	7550	3 S3 + 15 T14
7457	3 S1 + 6 T14 + 3 T15	7504	3 S2 + 8 T14 + 4 T15	7551	3 S3 + 10 T14 + 5 T15
7458	3 S1 + 3 T14 + 6 T15	7505	3 S2 + 4 T14 + 8 T15	7552	3 S3 + 5 T14 + 10 T15
7459	3 S1 + 9 T15	7506	3 S2 + 12 T15	7553	3 S3 + 15 T15
7460	3 S1 + 6 T15 + 3 T16	7507	3 S2 + 8 T15 + 4 T16	7554	3 S3 + 10 T15 + 5 T16
7461	3 S1 + 3 T15 + 6 T16	7508	3 S2 + 4 T15 + 8 T16	7555	3 S3 + 5 T15 + 10 T16
7462	3 S1 + 9 T16	7509	3 S2 + 12 T16	7556	3 S3 + 15 T16
7463	4 S1 + 6 T11 + 6 T13	7510	4 S2 + 8 T11 + 8 T13	7557	4 S3 + 10 T11 + 10 T13
7464	4 S1 + 3 T11 + 9 T13	7511	4 S2 + 4 T11 + 12 T13	7558	4 S3 + 5 T11 + 15 T13
7465	4 S1 + 12 T13	7512	4 S2 + 16 T13	7559	4 S3 + 20 T13
7466	4 S1 + 3 T14 + 9 T13	7513	4 S2 + 4 T14 + 12 T13	7560	4 S3 + 5 T14 + 15 T13
7467	4 S1 + 6 T13 + 6 T14	7514	4 S2 + 8 T13 + 8 T14	7561	4 S3 + 10 T13 + 10 T14
7468	4 S1 + 3 T13 + 9 T14	7515	4 S2 + 4 T13 + 12 T14	7562	4 S3 + 5 T13 + 15 T14
7469	4 S1 + 12 T14	7516	4 S2 + 16 T14	7563	4 S3 + 20 T14



**MAQUINARIA /
MACHINERY / MACHINES / MASCHINEN**

4.1	MANTECADORAS HELADO / ICE-CREAM MAKERS / TURBINES À GLACE / EISMASCHINEN	188
4.2	PROCESADOR ALIMENTOS / FOOD PROCESSORS / ROBOTS MULTIFONCTION / LEBENSMITTELMASCHINEN	193
4.3	BRAZOS TRITURADORES / IMMERSION BLENDERS / MIXEURS / STABMIXER	196
4.4	BATIDORAS / BLENDERS / MIXEURS/ MIXER	199
4.5	FREIDORAS / FRYERS / FRITEUSES/ FRITEUSEN	211
4.6	TOSTADORAS / TOASTERS / TOASTEURS/ TOASTER	213
4.7	GRILL DE CONTACTO Y PLANCHAS ELÉCTRICAS / CONTACT GRILL AND ELECTRIC GRIDDLES / GRILL DE CONTACT ET PLAQUES ÉLECTRIQUES / KONTAKTGRILL UND ELEKTRISCHE GRILLS	217
4.8	PLACAS INDUCCIÓN / INDUCTION HOBBS / PLAQUES INDUCTION / INDUKTIONSKOCHFELDER	221
4.9	HORNOS Y MICRO-ONDAS / OVENS & MICRO-WAVES / FOURS ET MICRO-ONDES / OFEN UND MIKROWELLEN	223
4.10	MAQUINARIA MANTENEDORA DE TEMPERATURA / MACHINERY FOR KEEPING TEMPERATURE / APPAREILS DE MAINIEN EN TEMPÉRATURE / WARMHALTEMASCHINEN	225

GELATO 5K CREA SC

La mantecadora más compacta totalmente automática / The most compact completely automatic ice-cream maker /
La turbine à glace la plus compacte totalement automatique / Die kompakteste vollautomatische Eismaschine

INOX - ST/STEEL
EDELSTAHL



70 RPM

REF	VOLUMEN CONTENEDOR / CONTAINER VOLUME / VOLUME CONTENEUR / GROSSER BEHÄLTER L	W	V	Hz	Kg	€	U
38.250.250	3,20	650	220-240	50	34	4.800,00	1

1,25 Kg / 1,75 L

Capacidad productiva por ciclo.
Production capacity per cycle.
Capacité productive par cycle.
Verbesserte Produktionskapazität
durch zyklischen Betrieb.

12-15 min.

Tiempo de preparación.
Preparation time.
Temps de préparation.
Zubereitungszeit.

5 Kg / 7,00 L

Preparación máxima horaria.
Maximum hourly preparation.
Préparation maximum horaire.
Maximierte stündliche Zubereitung.



Tapa con imán de seguridad.
Lid with safety magnet.
Couvercle à aimant de sécurité.
Deckel mit Magnetverschluss.



Introducción fácil de ingredientes.
Easy introduction of ingredients.
Introduction facile d'ingrédients.
Einfache Befüllung.



Sistema de desague, fácil limpieza.
Easy clean, drain system.
Système d'écoulement, nettoyage
facile.
Wasserablaufsystem, einfach zu
reinigen.

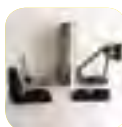

Raspadoras ajustables
extraíbles.
Adjustable removable blades.
Racloirs réglables amovibles.
Verstellbare Abstreifer,
abnehmbar.



Función manual.
Manual function.
Fonction manuelle.
Manueller Betrieb.



4 programas de mantecación.
4 ice-cream making programmes.
4 programmes de malaxage.
Vier Eiszubereitungsprogramme.



4 x 4 programas de conservación.
4 x 4 conserving programmes.
4 x 4 programmes de conservation.
4 x 4 Konservationsprogramme.

Mantecadora para producir, almacenar y distribuir helado.

1. Produce helado de forma automática y en poco tiempo.
2. Conserva el helado dentro de la máquina.
3. Distribuir el helado directamente.

Los 4 programas de mantecación.

- Gelato clásico.
- Gelato semi-soft.
- Granita (Granizado).
- Abatidor rápido de temperatura.

Control de la densidad automática. La pala se detiene automáticamente cuando el helado está listo.

Desagüe de limpieza.
Cuerpo y pala en acero inoxidable.
Refrigeración por aire. Gas R404.

Ice-cream maker to produce, store and dispense ice-cream.

1. Quickly and automatically produce ice-cream.
2. Conserve the ice-cream inside the machine.
3. Dispense ice-cream directly.

The 4 ice-cream making programmes.

- Classic ice-cream.
- Semi-soft ice-cream.
- Granita (crystallised ice).
- Fast chiller.

Automatic density control. The blade stops automatically when the ice cream is ready.
Cleaning drain.
Stainless steel body and blade.
Air cooling. Gas R404.

Turbine à glace pour produire, conserver et distribuer des glaces.

1. Produit des glaces de façon automatique et en peu de temps.
2. Conserve la glace dans la machine.
3. Distribue directement les glaces.

Les 4 programmes de malaxage.

- Gelato classique.
- Gelato semi-soft.
- Granita (Granité).
- Refroidisseur rapide de température.

Contrôle de densité automatique. La pale s'arrête automatiquement quand la glace est prête.
Écoulement de nettoyage.

Corps et pale en acier inoxydable.
Réfrigération à l'air. Gaz R404.

Eismaschine für die Herstellung, Aufbewahrung und Ausgabe von Eis

1. Automatische, schnelle Eisherstellung
2. Aufbewahrung des Eis in der Maschine
3. Ausgabe des Eis direkt aus der Maschine

Die vier Eiszubereitungsprogramme

- Klassisches Eis
- Halbweiches (semi-soft) Eis
- Granita (Slush - sizilianische Eisspeise).
- Schnellfrierprogramm

Automatische Kontrolle der Festigkeit. Die Rührklinge stoppt automatisch, wenn das Eis fertig ist.

Ablaufreinigung.
Körper und Klinge aus rostfreiem Stahl.
Luftkühlung. Gas R404

GELATO 5K SC

Mantecadora / Ice-cream maker / Turbine à glace / Eismaschine

INOX - ST/STEEL
EDELSTAHL



70 RPM

REF	VOLUMEN CONTENEDOR / CONTAINER VOLUME / VOLUME CONTENEUR / GROSSER BEHÄLTER L	W	V	Hz	Kg	€	U
38.240.250	3,20	600	220-240	50	34	3.900,00	1



Mantecadora para producir helados y sorbetes.

Control de la densidad automática. La pala se detiene automáticamente cuando el helado está listo. Desagüe de limpieza. Cuerpo, cubeta fija y pala (con insertos reemplazables) en acero inoxidable. Refrigeración por aire. Gas R404.

Turbine à glace pour produire des glaces et sorbets.

Contrôle automatique de densité. La pale s'arrête automatiquement quand la glace est prête. Écoulement de nettoyage. Corps, cuve fixe et pale (à inserts interchangeables) en acier inoxydable. Réfrigération par air. Gaz R404.

Ice-cream maker to produce ice-cream and sorbets.

Automatic density control. The blade stops automatically when the ice-cream is ready. Drain for cleaning. Body, fixed pail and blade (with replaceable inserts) in stainless steel. Air cooled. Gas R404.

Eismaschine für die Herstellung von Eis und Sorbets

Automatische Kontrolle der Festigkeit. Die Klinge stoppt automatisch, wenn das Eis fertig ist. Reinigungsablauf Körper, Eisbehälter und Schaufeln (mit auswechselbaren Einsätzen) Edelstahl Luftkühlung. Gas R404.



1. Tapa con imán de seguridad. Lid with safety magnet. Couvercle à aimant de sécurité. Deckel mit Magnetverschluss.
2. Introducción fácil de ingredientes. Easy introduction of ingredients. Introduction facile d'ingrédients. Einfache Befüllung.
3. Sistema de desagüe, fácil limpieza. Easy clean, drain system. Système d'écoulement, nettoyage facile. Wasserablaufsystem, einfach zu reinigen.
4. Raspadoras ajustables extraíbles. Adjustable removable blades. Raclours réglables amovibles. Verstellbare Abstreifer, abnehmbar.

1,25 Kg / 1,75 L

Capacidad productiva por ciclo. Production capacity per cycle. Capacité productive par cycle. Verbesserte Produktionskapazität durch zyklischen Betrieb.

12-15 min.

Tiempo de preparación. Preparation time. Temps de préparation. Zubereitungszeit.

5 Kg / 7,00 L

Preparación máxima horaria. Maximum hourly preparation. Préparation maximum horaire. Maximierte stündliche Zubereitung.



Ideal para los pequeños restaurantes. Ideal for small restaurants. Idéal pour les petits restaurants. Ideal für kleine Restaurants.

GELATO 3K TOUCH

MANTECADORAS / ICE-CREAM MAKERS / TURBINES À GLACE / EISMASCHINEN

INOX - ST/STEEL
EDELSTAHL



63 RPM

REF	VOLUMEN CONTENEDOR / CONTAINER VOLUME / VOLUME CONTENEUR / GROSSER BEHÄLTER L	W	V	Hz	Kg	€	U
38.550.250	1,70	350	220-240	50	21	2.800,00	1



Mantecadora para producir helados y sorbetes.

Control de la densidad automática. La pala se detiene automáticamente cuando el helado está listo. Desagüe de limpieza. Cuerpo, cubeta fija y pala (con insertos reemplazables) en acero inoxidable. Refrigeración por aire. Gas R404.

Turbine à glace pour produire des glaces et sorbets.

Contrôle automatique de densité. La pale s'arrête automatiquement quand la glace est prête. Corps, cuve fixe et pale (à inserts interchangeables) en acier inoxydable. Réfrigération par air. Gas R404.

Ice-cream maker to produce ice-cream and sorbets.

Automatic density control. The blade stops automatically when the ice-cream is ready. Body, fixed pail and blade (with replaceable inserts) in stainless steel. Air cooled. Gas R404.

Eismaschine für die Herstellung von Eis und Sorbets

Automatische Kontrolle der Festigkeit. Die Klinge stoppt automatisch, wenn das Eis fertig ist. Körper, Eisbehälter und Schaufeln (mit auswechselbaren Einsätzen) Edelstahl Luftkühlung. Gas R404.



1. Tapa con imán de seguridad. Lid with safety magnet. Couvercle à aimant de sécurité. Deckel mit Magnetverschluss.
2. Introducción fácil de ingredientes. Easy introduction of ingredients. Introduction facile d'ingrédients. Einfache Befüllung.
3. Sistema de desagüe, fácil limpieza. Easy clean, drain system. Système d'écoulement, nettoyage facile. Wasserablaufsystem, einfach zu reinigen.
4. Raspadoras ajustables extraíbles. Adjustable removable blades. Raclours réglables amovibles. Verstellbare Abstreifer, abnehmbar.

0,8 Kg / 1,20 L

Capacidad productiva por ciclo. Production capacity per cycle. Capacité productive par cycle. Verbesserte Produktionskapazität durch zyklischen Betrieb.

12-15 min.

Tiempo de preparación. Preparation time. Temps de préparation. Zubereitungszeit.

3 Kg / 4,40 L

Preparación máxima horaria. Maximum hourly preparation. Préparation maximum horaire. Maximierte stündliche Zubereitung.

GELATO CHEF 5L AUTOMATIC

MANTECADORAS / ICE-CREAM MAKERS / TURBINES À GLACE / EISMASCHINEN

INOX - ST/STEEL
EDELSTAHL



REF	VOLUMEN CONTENEDOR / CONTAINER VOLUME / VOLUME CONTENEUR / GROSSER BEHÄLTER L	W	V	Hz	Kg	€	U
36.790.250	2,50	280	220-240	50/60	20	2.000,00	1

63 RPM



Mantecadora para uso profesional.
Control de la densidad automática. La pala se detiene automáticamente cuando el helado está listo. Cuerpo, cubeta fija y pala (con insertos reemplazables) en acero inoxidable. Timer mecánico de 60 minutos. Refrigeración por aire. Gas R404.

Turbine à glace à usage professionnel.
Contrôle automatique de densité. La pale s'arrête automatiquement quand la glace est prête. Corps, cuve fixe et pale (à inserts interchangeables) en acier inoxydable. Minuteur mécanique de 60 minutes. Réfrigération par air. Gas R404.

Ice-cream maker for professional use.
Automatic density control. The blade stops automatically when the ice-cream is ready. Body, fixed pail and blade (with replaceable inserts) in stainless steel. 60 minute mechanical timer. Air cooled. Gas R404.

Eismaschine für die professionelle Nutzung.
Automatische Kontrolle der Festigkeit. Die Klinge stoppt automatisch, wenn das Eis fertig ist. Körper, Eisbehälter und Schaufeln (mit auswechselbaren Einsätzen) Edelstahl. Mechanische Zeitschaltuhr 60 Minuten. Luftkühlung. Gas R404.



1. Tapa con imán de seguridad.
Lid with safety magnet.
Couvercle à aimant de sécurité.
Deckel mit Magnetverschluss.
2. Temporizador e interruptor refrigeración.
Timer and cooling switch.
Temporisateur et interrupteur réfrigération.
Zeitschaltuhr für Gefrierprozess.
3. Cubeta extraíble (aluminio).
Removable pail (aluminium).
Cuve amovible (aluminium).
Herausnehmbarer Behälter (Aluminium).
4. Raspadoras extraíbles.
Removable blades.
Racloirs amovibles.
Herausnehmbare Abstreifer.

1 Kg / 1,50 L

Capacidad productiva por ciclo.
Production capacity per cycle.
Capacité productive par cycle.
Verbesserte Produktionskapazität durch zyklischen Betrieb.

20-30 min.

Tiempo de preparación.
Preparation time.
Temps de préparation.
Zubereitungszeit.

2 Kg / 3,20 L

Preparación máxima horaria.
Maximum hourly preparation.
Préparation maximum horaire.
Maximierte stündliche Zubereitung.

COMPARATIVA / COMPARISON / COMPARATIF / VERGLEICH

	GELATO 5K CREA SC	GELATO 5K SC	GELATO 3K TOUCH	GELATO CHEF 5L AUTOMATIC
Alimentación / Power supply / Alimentation / Befüllung	220-240 V 50 Hz 650 W	220-240 V 50 Hz 600 W	220-240 V 50 Hz 350 W	220-240 V 50/60 Hz 280 W
Potencia / Power / Puissance / Leistung				
Revoluciones por minuto / Revolutions per minute / Tours par minute / Umdrehungen pro Minute	70 RPM	70 RPM	63 RPM	63 RPM
Volumen contenedor / Container volume / Volume conteneur / Behältergröße	3,20 L	3,20 L	1,70 L	2,50 L
Desagüe / Drain / Vidange / Wasserablaufsystem	✓	✓	x	x
Cubeta extraíble / Removable pail / Cuve amovible / Herausnehmbarer Behälter	x	x	✓	✓
Capacidad productiva por ciclo / Production capacity per cycle / Capacité productive par cycle / Verbesserte Produktionskapazität durch zyklischen Betrieb	1,25 Kg / 1,75 L	1,25 Kg / 1,75 L	0,8 Kg / 1,20 L	1 Kg / 1,50 L
Tiempo de preparación / Preparation time / Temps de préparation / Zubereitungszeit	12-15 min.	12-15 min.	12-15 min.	20-30 min.
Preparación máxima horaria / Maximum hourly preparation / Préparation maximum horaire / Maximierte stündliche Zubereitung /	5 Kg / 7,00 L	5 Kg / 7,00 L	3 Kg / 4,40 L	2 Kg / 3,20 L
Programa de producción y conservación automática / Automatic production and preservation programme / Programme de production et conservation automatique / Programm für die automatische Produktion und Lagerung	✓	x	x	x
Dimensiones / Dimensions / Dimensions / Abmessungen	465 x 480 x 395 mm	465 x 480 x 395 mm	340 x 430 x 250 mm	450 x 320 x 315 mm
Peso neto / Net weight / Poids net / Nettogewicht	34 Kg	34 Kg	21 Kg	20 Kg
Precio / Price / Prix / Preis	4800,00 €	3900,00 €	2800,00 €	2000,00 €



**INOX - ST/STEEL
EDELSTAHL**

2000 RPM

- 2 velocidades (1-2 minutos).
- 2 speeds (1-2 minutes).
- 2 vitesses (1-2 minutes).
- 2 geschwindigkeiten (1-2 minuten).

FRIX'AIR

**Emulsionador y procesador de alimentos /
Food emulsifier and processor /
Émulsionneur et processeur d'aliments /
Emulgator und Küchenmaschine**

REF	W	V	Hz	Kg	€	U
94.500.250	600	220-240	50/60	21	3.100,00	1

Procesador profesional que permite emulsionar, mezclar y triturar tanto alimentos congelados como frescos.

- Frix'Air funciona con recipientes monodosis de 180 ml con muchas ventajas:
- Máxima higiene.
 - Congelación muy rápida.
 - Disponibilidad inmediata de varias preparaciones.
 - Garantiza la cadena de frío.
 - Ocupan poco espacio.
 - Apilables.

Professional processor that allows emulsifying, mixing and blending of both frozen and fresh food.

- Frix'Air works with 180 ml single-dose containers with many advantages:
- Maximum hygiene.
 - Very quick freezing.
 - Immediate availability of various preparations.
 - It guarantees the cold chain.
 - They take up little space.
 - Stackable.

Robot professionnel à émulsionner, mixer et mouliner des aliments surgelés ou frais.

- Frix'Air fonctionne à l'aide de récipients monodose de 180 ml offrant de nombreux avantages :
- Hygiène maximum.
 - Congélation très rapide.
 - Disponibilité immédiate de plusieurs préparations.
 - Garantit la chaîne du froid.
 - Prend peu de place.
 - Empilables.

Profi-Processor, zum Emulgieren, Mischen und Zerkleinern von sowohl gefrorene und auch frische Lebensmittel.

- Frix'Air arbeitet mit 180 ml Einzelbehältern mit vielen Vorteilen:
- Maximale Hygiene.
 - Sehr schnelles Einfrieren.
 - Sofortige Verfügbarkeit der verschiedenen Zubereitungen.
 - Gewährleistet Kühlkette.
 - Raumsparend.
 - Stapelbar.



Ideal para preparar mousses, sorbetes, helados, salsas, sopas, cócteles y aperitivos.

Ideal for preparing mousses, sorbets, ice-creams, sauces, soups, cocktails and aperitifs.

Idéal pour préparer des mousses, sorbets, glaces, sauces, soupes, cocktails et apéritifs.

Ideal für die Herstellung Mousses, Sorbets, Eis, Soßen, Suppen, Cocktails und Aperitifs.

**Set recipientes Frix'Air en plástico para congelador y microondas /
Set of Frix'Air plastic containers for freezers and microwaves /
Set récipients Frix'Air en plastique pour congélateur et micro-ondes /
Plastikbehälter Frix'Air zum Einfrieren und für die Mikrowelle**

REF	ml	Ø mm	h mm	€	U/pack
99.00.000	180	72	95	150,00	50



**H.A.C.C.P.
NO PROBLEM**

Colores / Colours / Couleurs / Farben



**Cada pack contiene 10 u. de cada color.
Each pack contains 10 units of each colour.
Chaque pack contient 10 u. de chaque couleur.
Jedes Set enthält zehn Stück jeder Farbe.**

Accesorios incluidos:

- 2 Cuchillas de acero inoxidable.
- 1 Cuchilla de plástico.
- 2 Junta protectora.
- 2 Lleva recipientes en acero.
- 5 Recipientes de plástico con tapa.
- 1 Desmontador de cuchilla.

Accessories included:

- 2 St/Steel blades.
- 1 Plastic blade.
- 2 Protective seals.
- 2 Stainless steel containers.
- 5 Plastic containers with lid.
- 1 Blade remover.

Accessoires inclus :

- 2 lames en acier inoxydable.
- 1 lame en plastique.
- 2 joints protecteurs.
- 2 Muni de récipients en acier.
- 5 Récipients en plastique avec couvercle.
- 1 Outil démontage de lame.

Zubehör im Lieferumfang enthalten:

- 2 Edelstahlklingen.
- 1 Kunststoffmesser.
- 2 Schutzstecker
- 2 Stahlbehälter eingeschlossen.
- 5 Kunststoffbehälter mit Deckel.
- 1 Abnehmbare Klinge.

Fácil identificación y separación de diferentes preparaciones.

Easy for identification and separation of different foodstuffs.

Identification et séparation faciles des différentes préparations.

Einfaches Erkennen und Unterscheiden unterschiedlicher Zubereitungen.



REBANADORAS Y CORTADORAS / SLICERS AND CUTTERS /
 TRANCHEURS ET COUPEURS / REIBEN UND SCHNEIDER

15090 / 15091 Cortadora eléctrica de fiambres / Electric slicing machine /
 Trancher électrique / Elektrische Aufschnittmaschine

REF	V	Hz	W	Ø CUCHILLA BLADE LAME MESSER cm	ESPESOR CORTE SLICER THICKNESS ÉPAISSEUR DE COUPE SCHNITTBREITE mm	Dim cm	Kg	€	U
15089	220	50	120	22	0-11	48 x 40 x 37	13,3	388,15	1
15090	220	50	150	25	0-11	48 x 40 x 37	14,3	480,10	1
15091	220	50	250	30	0-14	59 x 38 x 43	24,3	769,45	1



Ref. 15090
 Ø 25 cm
 Cuchilla / Blade / Lame / Messer

Cuerpo: aluminio pintado.
 Body: painted aluminium.
 Corps: aluminium peint.
 Körper : Aluminiumbeschichtet.



Ref. 15091
 Ø 30 cm
 Cuchilla / Blade / Lame / Messer

Cuerpo: aluminio anodizado.
 Body: anodized aluminium.
 Corps: aluminium anodisé.
 Körper : eloxiertes aluminium.

15095 Cortador de verduras / Vegetable cutter / Coupe-légumes / Gemüseschneider

Cuerpo / Body / Corps / Körper :
 Aluminio / Aluminium

150 Kg/h

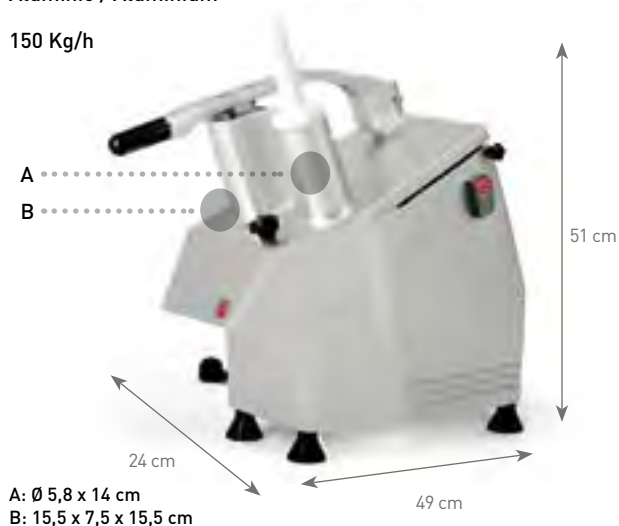

REF	V	Hz	W	Kg	€	U
15095	220	50	3/4 HP / 550 W	26,0	978,10	1

5 discos Incluidos / 5 disk included/ 5 lames Incluses / 5 Scheiben inklusive:
 Disco rallador de 3, 5 y 7 mm + Disco rebanador de 2 y 4 mm /
 Shredding disc 3, 4 & 7 mm + Slicing disc 2 & 4 mm /
 Disque à émincer de 3, 5 et 7 mm + Disque à trancher 2 et 4 mm /
 Scheibenschneider 3, 5 und 7 mm + Reibescheibe 2 und 4 mm

Disco rallador /
 Shredding disc /
 Disque à émincer /
 Reibscheibe



Disco rebanador /
 Slicing disc /
 Disque à trancher /
 Schneidscheibe



REF	CORTE / CUT COUPE / SCHNITT	€	U
RE15095-1	3 mm	50,35	1
RE15095-2	5 mm	50,35	1
RE15095-3	7 mm	50,35	1

REF	CORTE / CUT COUPE / SCHNITT	€	U
RE15095-4	2 mm	50,35	1
RE15095-5	4 mm	50,35	1

DISCOS DE RECAMBIO / REPLACEMENT DISCS / DISQUES DE RÉCHANGE / WECHSELSCHEIBEN

Disco patatas fritas /
 French fries disc /
 Disque Coupe frites /
 Pommesschneider



Disco para dados /
 Dicing disc /
 Disque dés /
 Würfelscheibe



Disco rebanador
 complementario /
 Complementary
 slicing disc /
 Disque laminoir
 complémentaire /
 Ergänzende
 Schneidscheibe



*Para cortar patatas fritas o dados es imprescindible utilizar junto con el disco rebanador complementario.

*In order to cut chipped or diced potatoes the use of the complementary slicing disc is essential.

*Pour couper des frites ou des dés, il est indispensable d'utiliser, avec le disque, le laminoir complémentaire.

*Zum Schneiden von Pommes Frites oder für Würfel, ist die Benutzung der Zusatzscheibe unabdinglich.

REF	CORTE / CUT COUPE / SCHNITT	€	U
RE15095-6	8 x 8	98,35	1
RE15095-7	10 x 10	98,35	1

REF	CORTE / CUT COUPE / SCHNITT	€	U
RE15095-8	8 x 8	124,20	1
RE15095-9	10 x 10	124,20	1

REF	CORTE / CUT COUPE / SCHNITT	€	U
RE15095-10	8 x 8	71,50	1
RE15095-11	10 x 10	71,50	1

WFP16SE / WFP16SCDE

Procesador de alimentos de 3.75 L con cierre hermético LiquiLock /
3.75-Litre Commercial Food Processor with LiquiLock Seal System /
Robot multifonction avec bol de 3.75 L et système d'étanchéité LiquiLock /
3.75 Liter Multifunktionsroboter mit hermetisches Verschlussystem LiquiLock



REF	Lts	Potencia/Power	€	U
WFP16SE	3,75	2HP	1.174,00	1
WFP16SCDE*	3,75	2HP	1.628,85	1

Bol transparente de 3,75 L con sello hermético LiquiLock, ideal para procesar sopas, salsa, aderezos y mucho más. Motor de inducción de 2 HP. Incluye una cuchilla hermética, un disco rebanador ajustable, un disco triturador/rallador reversible y un disco batidor hermético.

Los modelos WFP16SCDE también incluyen un bol para procesado continuo.
*El modelo WFP16SCDE incluye 2 bols: transparente + continuo. Base de aluminio de fundición extremadamente resistente para uso intensivo.

LiquiLock Seal System – perfect for processing soups, sauces, dressings and more. 2 HP induction motor. Includes Sealed S-Blade, Adjustable Slicing Disc, Reversible Shredding Disc and Sealed Whipping Disc.
*WFP16SCDE includes clear + continuous bowl. Heavy-duty die-cast base.

Bol transparente de 3,75 L avec système d'étanchéité LiquiLock – parfait pour les soupes, sauces, vinaigrettes et plus encore. Moteur à induction de 2 HP. Inclut un couteau, un disque à trancher réglable, un disque à émincer réversible, un disque à râper 2 mm et un disque à fouetter hermétique.

*Le modèle WFP16SCDE inclus 2 bols: Transparente + continu. Socle robuste en fonte d'aluminium.

Transparenter 3.75 L Behälter mit hermetisches Verschlussystem LiquiLock ideal für die Zubereitung von Suppen, Sossen, Dressings und vielem mehr. 2 HP Induktionsmotor. Inklusive ein hermetisches Messer, ein einstellbarer Scheibenschneider, eine reversible Reib/Häcklerscheibe und ein hermetischer Mixer. Die Modelle *Das Model WFP16SCDE ist inklusive 2 Behälter: transparent + kontinuierlich. Der Mixerarm ist für den leichten Gebrauch.

EL PRECIO INCLUYE LOS SIGUIENTES ACCESORIOS /
THE FOLLOWING ACCESSORIES ARE INCLUDED ON THE PRICE /
LES PRIX COMPRIS LES SUIVANTS ACCESSOIRES /
DER PREIS BEINHaltet FOLGENDE ACCESSORIES



Bol hermético.
Sealed Batch Bowl.
Bol hermétique.
Hermetischer Behälter.

Lique sopas, salsas, adobos y mucho más, sin derrame.
Process soups, sauces, marinades and more without leaks.
Mixez soupes, sauces, marinades et plus encore, sans fuites.
Zubereitung von Suppen, Sossen, Dressings und vieles mehr, ohne überlaufen.



Cuchilla hermética con sistema de bloqueo.
Sealed & Locked S-Blade.
Lame hermétique avec système de blocage.
Hermetisches Messer mit Blockiersystem.

Permanece en posición al vaciar el bol, para mayor comodidad y seguridad.
Blade locks in place for easier, safer pouring.
Le couteau reste en place lorsqu'on vide le bol, pour un maximum de sûreté.
Permanente Position des Messers im Behälter, für mehr Sicherheit und Bequemlichkeit.

Accesorios adicionales / Additional discs / Accessoires additinells / Zusatzartikel



Disco rebanador ajustable
Adjustable Slicing Disc
Disque à trancher réglable
Einstellbarer Scheibenschneider

REF	€	U
WFP16S10	59,45	1



Disco batidor hermético
Sealed Whipping Disc
Disque à fouetter hermétique
Hermetische Mixerscheibe

REF	€	U
WFP16S11	123,90	1



Disco triturador / rallador reversible
Reversible Shredding Disc
Disque à émincer réversible
reversible Reib / Häcklerscheibe

REF	€	U
WFP16S12	56,75	1



Cuchilla hermética
Sealed, serrated S-blade
Lame hermétique
Hermetisches Messer

REF	€	U
WFP16S1	163,10	1

PROCESADOR ALIMENTOS / FOOD PROCESSORS /
ROBOTS MULTIFONCTION / LEBENSMITTELMASCHINEN



Ref. WFP14SE



Ref. WFP14SCE

WFP14SE / WFP14SCE

Procesador de alimentos de 3.35 l con cierre hermético LiquiLock /
3.35-Litre Commercial Food Processor with LiquiLock Seal System /
Robot multifonction avec bol de 3.35 l et système d'étanchéité LiquiLock /
3.35 Liter Küchenroboter mit hermetischem Verschlussystem LiquiLock

REF	W	€	U
WFP14SE	1 HP/745W	867,00	1
WFP14SCE*	1 HP/745W	884,80	1

Bol transparente de 3,35 L con sello hermético LiquiLock, ideal para procesar sopas, salsa, aderezos y mucho más.

Motor de inducción de 1 HP.
Incluye una cuchilla hermética, un disco rebanador ajustable, un disco triturador/rallador reversible y un disco batidor hermético.

*El modelo WFP14SCE incluye 2 bols: transparente + continuo.

3.35-litre clear-view batch bowl with LiquiLock Seal System – perfect for processing soups, sauces, dressings and more.

1 HP induction motor.
Includes Sealed S-Blade, Adjustable Slicing Disc, Reversible Shredding Disc and Sealed Whipping Disc.

*WFP14SCE includes clear + continuous bowl.

Bol transparent de 3,35 L avec système d'étanchéité LiquiLock – parfait pour les soupes, sauces, vinaigrettes et plus encore.

Moteur à induction de 1 HP.
Inclut un couteau, un disque à trancher réglable, un disque à émincer réversible, un disque à râper 2 mm et un disque à fouetter hermétique.

*Le modèle WFP14SCE inclus 2 bols: Transperente + continu.

Durchsichtige Behälter mit hermetischem Verschlussystem LiquiLock ideal für die Zubereitung von Suppen, Sossen, Dressings und vieles mehr.

1 HP Induktionsmotor.
Inklusive ein hermetisches Messer, ein einstellbarer Scheibenschneider, eine reversible Reibe/Häckslerscheibe und ein hermetischer Mixer. Die Modelle.

*Das Model WFP14SCE ist inklusive 2 Behälter: transparent + kontinuierlich.

EL PRECIO INCLUYE LOS SIGUIENTES ACCESORIOS /
THE FOLLOWING ACCESSORIES ARE INCLUDED ON THE PRICE /
LES PRIX COMPRIS LES SUIVANTS ACCESSOIRES /
DER PREIS BEINHaltet FOLGENDE ACCESSORIES



Bol hermético.
Sealed Batch Bowl.
Bol hermétique.
Hermetischer Behälter.

Lique sopas, salsas, adobos y mucho más, sin derrame.
Process soups, sauces, marinades and more without leaks.
Mixez soupes, sauces, marinades et plus encore, sans fuites.
Zubereitung von Suppen, Sossen, Dressings und vieles mehr, ohne überlaufen.



Cuchilla hermética con sistema de bloqueo.
Sealed & Locked S-Blade.
Lame hermétique avec système de blocage.
Hermetisches Messer mit Blockiersystem.

Permanece en posición al vaciar el bol, para mayor comodidad y seguridad.
Blade locks in place for easier, safer pouring.
Le couteau reste en place lorsqu'on vide le bol, pour un maximum de sûreté.
Permanente Position des Messers im Behälter, für mehr Sicherheit und Bequemlichkeit.

Accesorios adicionales / Additional discs / Accessoires additinnells / Zusatzartikel



0,5 - 6 mm

Disco rebanador ajustable
Adjustable Slicing Disc
Disque à trancher réglable
Einstellbarer Scheibenschneider

REF	€	U
WFP14S10	61,00	1



Disco batidor hermético
Sealed Whipping Disc
Disque à fouetter hermétique
Hermetische Mixerscheibe

REF	€	U
WFP14S11	123,95	1



Disco triturador / rallador reversible
Reversible Shredding Disc
Disque à émincer réversible
Reversible Reib / Häckslerscheibe

REF	€	U
WFP14S12	56,80	1



Cuchilla hermética
Sealed, serrated S-blade
Lame hermétique
Hermetisches Messer

REF	€	U
WFP14S1	163,10	1



Ref. WFP116



Ref. WFP113



WFP7E

Procesador de alimentos de 1.7 L /
1.7-Liter Commercial Food Processor /
Robot de cuisine professionnel de 1,7 L /
1.7 Liter Küchenroboter

REF	W	€	U
WFP7E	3/4 HP / 560W	366,15	1

Motor de servicio pesado de 3/4 HP/560W.
Bol transparente irrompible.
Control de ENCENDIDO/APAGADO/PULSO fácil de usar.
Cuchilla tipo "S" de acero inoxidable para picar, moler, mezclar y hacer purés (WFP7K1), disco rebanador 2 mm (WFP116), disco rallador fino (WFP113) y adaptador amovible (WFP7K2).
Juego de empujadores con sistema de seguridad.
230V CA, 50 Hz, 410 vatios, 1.8 A
Homologado CE y RoHS.

Moteur haute performance de 3/4 HP/560W.
Bol transparent incassable.
Touche MARCHE/ARRÊT/PULSE facile à utiliser.
Couteau en acier inoxydable pour hacher, broyer, mélanger et réduire en purée (WFP7K1), disque à trancher 2 mm (WFP116), disque à râper fin (WFP113) et adaptateur amovible (WFP7K2).
Petit et gros poussoirs avec mécanisme de sécurité.
230V C.A., 50 Hz, 410 watts, 1,8 A
Homologué CE et RoHS.

Heavy-duty 3/4 HP high performance motor/560W.
Clear-view unbreakable workbowl.
Easy ON/OFF/PULSE control
Stainless steel serrated S-blade to chop, grind, mix, and purée (WFP7K1), 2 mm slicing disc (WFP116), fine grating disc (WFP113), and detachable disc stem (WFP7K2).
Small and large pushers with safety interlock sleeve.
230 VAC, 50 Hz, 410 W, 1.8 amps
CE, RoHS.

Hochleistungsmotor 3/4 HP/560W.
Unzerbrechlicher transparenter Behälter. Einfache EIN/AUS/PULSE Bedienung.
Messer Typ "S" aus rostfreiem Stahl zum Zerkleinern, Mahlen, Mixen und Pürieren (WFP7K1), Schneidscheibe 2 mm (WFP116), feine Reibscheibe (WFP113) und austauschbarer Adapter (WFP7K2).
Schubsatz mit Sicherheitssystem.
230 V CA, 50 Hz, 410 W, 1.8 A
Zertifiziert mit CE, RoHS.

WCG75E

Picadora - Moledora Pro Prep /
Pro Prep Chopper Grinder /
Hachoir - Broyeur Pro Prep /
Fleischwolf - Mühle Pro Prep

REF	W	€	U
WCG75E	3/4 HP / 560W	298,35	1

Capacidad de 700 ml .
Dos juegos de bol y cuchilla: uno para picar y otro para moler
Potente motor de inducción de dos polos, de 3/4 HP/560W.
230V CA, 50 Hz, 0.9 A.
Homologado RoHS.

Capacité de 700 ml.
Deux bols/couteaux : un pour mouder et un pour émincer. Puissant moteur 2 pôles à induction de 3/4 HP/560W.
230V C.A., 50 Hz, 0,9 A.
Homologué RoHS.

700 ml capacity.
Two separate bowl and blade assemblies: one for grinding — one for chopping.
Powerful high-speed 2-pole 3/4 HP induction motor/560W.
230V VAC, 50 Hz, 0.9 amps.
RoHS.

700 ml Fassungsvermögen.
2 Behälter und Messer; eines für den Fleischwolf eines für die Mühle.
Starker Induktionsmotor mit zwei Polen, von 3/4 HP/560W.
230V CA, 50 Hz, 0.9 A
Zertifiziert mit RoHS.



Lleve a cabo cualquier tarea de mezclado/licuado con los brazos trituradores portátiles Waring Commercial. Desde el versátil modelo QuickStik hasta el modelo de servicio pesado de 1 HP Big Stix, estos brazos trituradores son herramientas básicas para las cocinas más atareadas de hoy. Con varillas de 17.75 a 53.5 cm, permiten procesar desde 11.5 hasta 200 litros a la vez. Las cuchillas multifunción de acero inoxidable garantizan un licuado homogéneo, y el cómodo mango ofrece mayor control. ¡Licue, bata, mezcle y haga purés sin esfuerzo gracias a Waring!

Power through any mixture with the portable handheld Waring Commercial Immersion Blenders. From the versatile QuikStik to the heavy-duty 1 HP Big Stix, these are essential tools for today's busy kitchens. The shaft sizes range from 17.75 cm to 53.5 cm with capacities from 11.5 to 200 liters. The all-purpose stainless steel blades ensure smooth, consistent blending, and the comfort grips keep the user in control. Blend, whisk, mix, purée and whip with Waring!

Mixez en toute facilité grâce aux mixeurs Waring Commercial. Du plus pratique (le QuikStik) au plus puissant (le Big Stix de 1 HP), ce sont des outils essentiels pour les cuisines modernes. Leurs pieds de 17,75 à 53,5 cm permettent de mixer 11,5 à 200 L à la fois. Leurs lames en acier inoxydable garantissent des résultats homogènes. Leurs poignées ergonomiques offrent un maximum de confort. Mixez, fouettez, mélangez et réduisez en purée sans effort grâce à Waring !

Leistungsstarkes Mixen und Verflüssigen mit den Stabmixern Waring Commercial. Von dem vielseitigen Modell QuickStik bis hin zum robusten 1 HP Big Stix sind diese Stabmixer heutzutage ein wesentliches Werkzeug der vielbeschäftigten modernen Küchen. Mit Stablängen von 7.75 bis 53.5 cm kann man von 11.5 bis 200 Liter auf einmal bearbeiten. Die Multifunktionsmesser aus rostfreiem Stahl garantieren ein homogenes Zerkleinern und die bequemen Griffe bieten eine gute Kontrolle. Verflüssigen, Mixen und Pürieren Sie mühelos mit Waring!

WSB50E / WSB55E / WSB60E / WSB65E / WSB70E

Brazo triturador de servicio pesado Big Stix /
Heavy-Duty Big Stix /
Mixeur à usage intensif Big Stix /
Einarmiger Hochleistungsstabmixer Big Stix



WSB50E
30,5 cm / 40 L

WSB55E
35,5 cm / 60 L

WSB60E
40,5 cm / 100 L



WSB65E
45,5 cm / 140 L

WSB70E
53,5 cm / 200 L



WSB50ST

WSB55ST

WSB60ST

WSB65ST

WSB70ST



WSBPPCE

Bloque motor / Bloc-moteur
Power Pack / Motorblock

REF	€	U
WSBPPCE	321,00	1

WSBBC

Abrazadera / Pince
Bowl Clamp / Halter

REF	€	U
WSBBC	131,70	1

REF	VARILLA EXTRAIBLE / REMOVABLE SHAFT / PIED AMOVIBLE / ABNEHMBARER STAB	CAPACIDAD / CAPACITY / CAPACITÉ / KAPAZITÄT	€	U
WSB50E (50 Hz)	30,5 cm	40 L	476,00	1
WSB55E (50 Hz)	35,5 cm	60 L	494,30	1
WSB60E (50 Hz)	40,5 cm	100 L	518,65	1
WSB65E (50 Hz)	45,5 cm	140 L	533,40	1
WSB70E (50 Hz)	53,5 cm	200 L	549,15	1

VARILLA / SHAFT / PIÉD / STAB

REF	VARILLA EXTRAIBLE / REMOVABLE SHAFT / PIED AMOVIBLE / ABNEHMBARER STAB	€	U
WSB50ST	30,5 cm	183,90	1
WSB55ST	35,5 cm	189,80	1
WSB60ST	40,5 cm	201,70	1
WSB65ST	45,5 cm	213,65	1
WSB70ST	53,5 cm	225,45	1

Bloque motor universal adaptable a todos los brazos y batidores.
Motor de servicio pesado de 1 HP (potencia de entrada máxima)
Velocidad variable.
18 000 RPM a velocidad alta (1600 RPM con los batidores).
Función de encendido continuo.
Acoplamientos (bloque-motor y varilla) reemplazables por el usuario.
Cómodo mango cubierto de caucho y empuñadura auxiliar, para mayor control y seguridad.
Varilla de acero inoxidable sellada, removible y apta para lavavajillas.

Universal power pack fits all shafts and whisk attachments.
1 peak input HP heavy-duty motor.
Variable speed operation
18,000 RPM on high (1,600 for whipping paddles).
Continuous ON feature.
User-replaceable couplings on power pack and shaft.
Rubberized comfort grip and second handle for safe and controlled operation.
Completely sealed stainless steel shaft is easily removable and dishwasher safe.

Bloc-moteur universel adaptable à tous les pieds et fouets.
Moteur haute performance de 1 HP (puissance d'entrée maximale).
Vitesse variable.
18.000 tr/mn à haute vitesse (1 600 tr/mn avec les fouets).
Marche continue.
Accouplements (bloc-moteur et pied) faciles à changer.
Poignée caoutchoutée et poignée auxiliaire, pour davantage de confort et de sécurité.
Pied hermétique en acier inoxydable, amovible et compatible lave-vaisselle.

Universeller Motorblock geeignet für alle Stablängen und Halter.
Hochleistungsmotor von 1 HP (max. Eingangsleistung). Variable Geschwindigkeit. Max. 18.000 U/min (1.600 U/min. Rührbesen).
Funktion Dauerbetrieb.
Durch Kopplung (Motorblock - Stab) vom Benutzer austauschbar.
Bequemer Griff mit Kautschukbeschichtung und Hilfsgriff bieten eine höhere Kontrolle und Sicherheit. Stab aus versiegeltem rostfreiem Stahl, austauschbar und Spülmaschinen geeignet.



1600 RPM

INOX - ST/STEEL
EDELSTAHL



WSB2W
Accesorio batidor
Whisk Attachment
Fouets
Rührbesen Zubehör

REF	L cm	€	U
WSB2W	25,5	238,05	1



WSB01
Gancho colgador
Wall Hook
Crochet de suspension
Aufhängehaken

REF	€	U
WSB01	36,60	1

WSBPPWE

Batidor de servicio pesado Big Stik /
Heavy-Duty Big Stik with whisk attachment /
Mixeur à usage intensif Big Stik avec fouets /
Hochleistungsstabmixer Big Stik

REF	W	€	U
WSBPPWE	1 HP / 650 W	567,50	1



Acoplamientos (bloque-motor y accesorio batidor) reemplazables por el usuario.
Caja de engranaje de fundición, para mejor desempeño.

Accouplements (bloc-moteur et batteurs) faciles à changer.
Engrenage en acier moulé, pour des performances optimales.

User-replaceable couplings on powerpack and whisk attachment.
Die-cast gears for optimal performance.

Durch Kopplung (Motorblock - Stab) vom Benutzer austauschbar.
Gegossenes Getriebegehäuse für eine bessere Performenz.

WSB33XE

Brazo triturador de servicio ligero Quik Stik /
Light-Duty Quik Stik /
Mixeur Quick Stik à usage léger /
Stabmixer leichter Gebrauch Quik Stik

REF	€	U
WSB33XE	113,35	1

Motor de alta eficacia, con dos velocidades
Varilla fija de 17.75 cm
Capacidad de 11.5 litros
230V, 50 Hz, 0.4 A, 175W
Homologado CE y RoHS

Moteur hautement efficace à deux vitesses
Pied fixe de 17,75 cm
Capacité de 11,5 litres
230V, 50 Hz, 0,4A, 175W
Homologué CE et RoHS

2-speed high-efficiency motor
17.75 cm fixed shaft
11.5-liter capacity
230 volts, 50 Hz, 0.4 amps, 175W
CE, RoHS

Motor mit hoher Leistung und zwei Geschwindigkeiten und festem Stab von 17.75 cm Länge.
Bearbeitungsvermögen 11.5 Liter. 230V, 50 Hz, 0.4 A, 175W
Zertifiziert mit CE und RoHS



WSB40E

Brazo triturador de servicio mediano Quik Stik Plus /
Medium-Duty Quik Stik Plus /
Mixeur Quick Stik Plus à usage moyen /
Stabmixer mittlerer Gebrauch Quik Stik Plus

REF	€	U
WSB40E	315,05	1

Motor de servicio pesado de 1/2 HP, con 2 velocidades/370W.
Varilla fija de 25.5 cm.
Capacidad de 23 litros
230V, 50 Hz, 1.5 A.
Homologado CE y RoHS.

Puissant moteur de 1/2 HP, à deux vitesses/370W.
Pied fixe de 25,5 cm.
Capacité de 23 litres.
230V, 50 Hz, 1,5A.
Homologué CE et RoHS.

1/2 HP, 2-speed heavy-duty motor/370W.
25.5 cm fixed shaft.
23-liter capacity .
230 volts, 50 Hz, 1.5 amps. CE, RoHS

Ochleistungsmotor von 1/2 HP, mit 2 Geschwindigkeiten /370W.
Fester Stab von 25.5 cm.
Bearbeitungsvermögen 23 Liter. 230V, 50 Hz, 1,5 A, Zertifiziert mit CE und RoHS





Desde 1937, Waring Commercial domina el mercado de las batidoras de vaso profesionales, gracias a sus potentes batidoras de alto rendimiento. Equipadas con motores de servicio pesado de hasta 2800W, estas rápidas e inigualables herramientas son capaces de licuar cualquier combinación de alimentos, rápidamente y sin esfuerzo. Sus vasos de policarbonato, cristal o acero inoxidable con capacidad de 1 a 4 litros han sido diseñados para satisfacer las exigencias de cualquier cocina comercial. ¡Estas potentes batidoras son herramientas básicas, con habilidades excepcionales!

Since 1937, the Waring Commercial Blender has led the industry in power and performance. With unequalled speed and efficiency, the heavy-duty motors use up to 2800W to power through any combination of ingredients in no time. Capacities range from 1 to 4 liters with polycarbonate, glass, and stainless containers designed to meet the demands of every commercial kitchen. It's the basic tool with exceptional abilities!

Depuis 1937, les puissants bols mixeurs à usage intensif Waring Commercial dominent le marché des bols mixeurs professionnels. Équipés de moteurs haute performance jusqu'à 2800W, ces puissants appareils sont capables de mixer n'importe quels ingrédients, rapidement et sans effort. Leurs bols en polycarbonate, verre ou acier inoxydable de 1 à 4 L ont été conçus pour répondre aux exigences de toutes les cuisines commerciales.

Des outils de base...un talent hors du commun !

Seit 1937 dominiert Waring Commercial den Markt der professionellen Standmixer und Behälter, dank seiner leistungsstarken Mixer. Ausgestattet mit starken und effizienten Motoren bis zu 2800W sind sie schnelle und unvergleichbare Werkzeuge, die jedwede Lebensmittelkombination verflüssigen; schnell und einfach. Ihre Behälter aus Polycarbonat, Glas oder Edelstahl mit einem Fassungsvermögen von 1 bis 4 Liter sind entwickelt worden um die Ansprüche der professionellen Küche zufriedenzustellen. Diese leistungsstarken Standixer sind Basiswerkzeuge mit aussergewöhnlichen Qualitäten!



20500 RPM - 2,2 A



BB180PE

Batidora de vaso comercial NuBlend /
NuBlend Commercial Blender /
Mixeur à jarre commerciale NuBlend /
Gewerblicher Standmixer NuBlend

REF	V	W	Hz	€	U
BB180PE	230	3/4HP / 560W	50/60	323,40	1

Jarra copoliéster.
Controles mecánicos: Alto, Bajo,
Apagado y Pulso.

Bol en copolyester.
Interrupteurs à bascule: Haut, Bas, Arrêt
et Pulse.

Copolyester container.
High, Low, Off and Pulse toggle switches.

Behälter aus copolyester.
Mechanische Kontrolle: High, Low, Off
und Puls.



CAC87

Jarra / Container /
Bol / Karaffen

REF	Lts	€	U
CAC87	1,40	103,40	1



20500 RPM - 2,2 A



BB185PE

Batidora de vaso comercial NuBlend /
NuBlend Commercial Blender /
Mixeur à jarre commerciale NuBlend /
Gewerblicher Standmixer NuBlend

REF	V	W	Hz	€	U
BB185PE	230	3/4HP / 560W	50/60	323,40	1

Jarra copoliéster.
Controles electrónicos: Alto, Bajo,
Apagado y Pulso.

Bol en copolyester.
Contrôle électronique: Haut, Bas, Arrêt
et Pulse.

Copolyester container.
High, Low, Off and Pulse electronic
controls.

Behälter aus copolyester.
Elektronische Kontrolle: High, Low, Off
und Puls.

24500 RPM - 3,3 A



Ref. HGB25E



Ref. CAC31

HGB25E

Batidora de vaso de 2 litros /
2-Liter food blender /
Blender de 2 litres /
2 Liter Standmixer

REF	Lts	V	W	Hz	€	U
HGB25E	2	220-240	1,5 HP / 1120 W	50/60	549,10	1
CAC31	2	Jarra/Jar/Pot/Behälter			264,45	1

2 velocidades.
Jarra y cuchilla de acero inoxidable.
Acoplamiento de eje de caucho reforzado
con metal, fácil de reemplazar.

2 vitesses.
Bol et couteau en acier inoxydable.
Accouplement renforcé en métal, facile à
remplacer.

2 speeds.
Stainless steel container and blade.
Easily replaceable metal-reinforced rubber
drive coupling

2 geschwindigkeiten.
Behälter und Messer aus rostfreiem Stahl.
Kupplungsachse aus Kautschuk mit
metallischer Verstärkung, einfach
austauschbar.



Las batidoras de vaso profesionales Waring Commercial son herramientas esenciales para cualquier bar o restaurante. Esta línea clásica siempre logra resultados profesionales, gracias a características profesionales: resistentes jarras de alta capacidad de acero inoxidable, copoliéster sin bisfenol-A o cristal; potentes motores de hasta 1120W y cuchillas de acero inoxidable que siempre logran resultados rápidos y homogéneos. ¡Pique hielo y prepare bebidas en tan sólo segundos con las potentes licuadoras profesionales Waring Commercial!

The staple in any bar or restaurant, the Waring Commercial Blender consistently delivers a professional blend. This classic product line offers a variety of sizes, styles and capacities in durable stainless, BPA-free copolyester, or glass containers. Powerful, professional motors with up to 1120W HP drive stainless steel cutting blades for quick, consistent results. Crush ice in seconds and make drinks instantly with the power of Waring Commercial!

Les blenders Waring Commercial sont les outils de base par excellence pour tout type de bar ou restaurant. Disponibles en plusieurs tailles et styles (acier inoxydable, copolyester sans BPA, verre), ces outils classiques sont équipés de puissants moteurs professionnels jusqu'à 1120W et de couteaux en acier inoxydable, pour des résultats rapides et homogènes. Broyez de la glace et préparez des boissons en quelques secondes grâce aux puissants bols mixeurs Waring Commercial!

Die professionellen Standmixer von Waring Commercial sind essentielle Werkzeuge für jede Bar oder Restaurant. Die klassische Produktlinie bietet immer professionelle Ergebnisse, dank seiner professionellen Eigenschaften:

Resistente Behälter von grossem Fassungsvermögen aus rostfreiem Stahl, Glas oder Copolyester ohne Bisfenol-A (BPA); leistungsstarken Motoren von bis zu 1120W und messer aus rostfreiem Stahl, die immer für ein schnelles und homogenes Ergebnis sorgen. Zerkleinern Sie Eis und bereiten Sie Getränke in Sekundenschnelle mit den leistungsstarken Mixern von Waring Commercial!

BATIDORAS PARA ALIMENTOS & CÓCTELES / FOOD & BAR BLENDERS / BOLS MIXEURS / ESSENS- U. GETRÄNKEMIXER

MARGARITA Batidoras de vaso "Elite" / Elite Series Blenders / Blenders "Elite" / Mixer "Elite"

32000 RPM

Jarra apilable transparente de 1.4 L resistente, de servicio pesado y de calidad profesional. Diseño único, para máxima eficacia y rendimiento.

1.4L clear-view stackable jar – commercial grade, heavy-duty and break-resistant. Uniquely shaped for maximum efficiency and performance.

Resistente cuchilla de acero inoxidable con robustas piezas de acero, hechas para durar pero reemplazables por el usuario. Su forma "agresiva" ha sido especialmente diseñada para este vaso y es capaz de picar hielo al instante.

Heavy-duty stainless steel blade with solid steel blending assembly – built to last but completely user-replaceable. This aggressive blade design is configured specifically for this jar and is engineered to crush ice instantly.

Base resistente y compacta con potente motor de 2 HP/1490 vatios y cojinete amortiguador removible para facilitar la limpieza.

Heavy-duty base with powerful 2 HP, 1490W motor – this amazing combination makes for big power yet small foot print and includes a removable jar pad for easy cleanup.

Bol transparent empilable de 1,4 L résistant, à usage intensif et de qualité professionnelle. Spécialement conçu pour maximiser l'efficacité et le rendement.

1,4 l stapelbarer transparenter Behälter, resistent gegen häufigen Gebrauch und mit professioneller Qualität. Einzigartiges Design für höchste Effizienz und Leistung.

Couteau en acier inoxydable avec pièces en acier massif construits pour durer mais remplaçables par l'utilisateur. Couteau "agressif" spécialement conçu pour le bol et capable de broyer la glace instantanément.

Resistente Messer aus rostfreiem Stahl mit robusten Stahlteilen, gemacht für Langlebigkeit aber auch durch den Benutzer austauschbar. Die "aggressive" Form ist speziell für den Behälter disignt und ist in der Lage Eis sehr schnell zu crashen.

Boitier résistant et compact avec puissant moteur de 2 HP/1490W et coussin amortisseur amovible pour faciliter le nettoyage.

Resistente und kompakte Basis mit einem leistungsstarkem Motor von 2 HP, 1490W und mit abnehmbarer Stossdämpfungseinheit zur einfachen Reinigung.

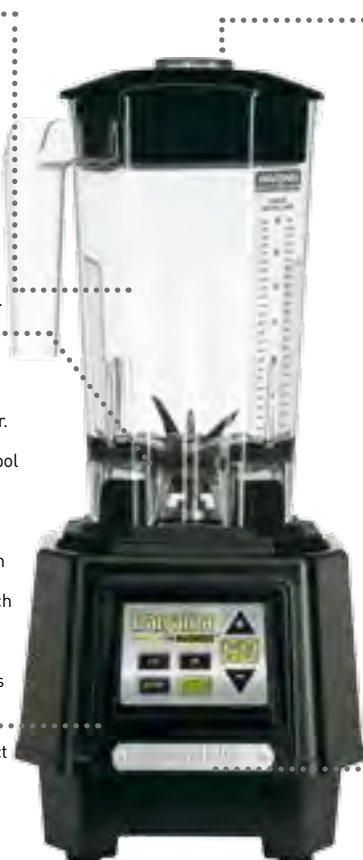

Tapa para alimentos/ líquidos calientes de vino con tapón extraíble.

Vinyl lid for hot food/ beverage blending and removable center cap that locks into place or can be removed to feed ingredients while blending.

Couvercle en vinyle pour aliments/liquides chauds avec bouchon doseur amovible.

Deckel für heiße Lebensmittel/ Flüssigkeiten aus Vinyl mit abnehmbaren Verschlusskopf.

Controles HI/LO/STOP/PULSE con temporizador de cuenta progresiva de 60 segundos (modelos sin temporizador también disponibles) – Las batidoras de vaso Margarita Madness® Elite vienen equipadas con tres tipos de controles: mecánicos, electrónicos y electrónicos con temporizador.

HI/LO/STOP/PULSE controls with 60-second countdown timer (non-timer versions available) – the Margarita Madness Elite Series Blenders feature three control styles – a simple toggle switch control, electronic keypad and electronic keypad with 60-second countdown timer.

Commandes HAUT/BAS/ ARRÊT et PULSE avec minuteur de 60 secondes (modèles sans minuteur également disponibles). Les bols mixeurs de la série Margarita Madness Elite sont disponibles en trois styles : commandes mécaniques, commandes électroniques ou commandes électroniques avec minuteur de 60 secondes.

HI/LO/STOP/PULSE Kontrolle mit 60 Sekunden Countdown. (Modelle ohne Timerfunktion auch erhältlich) – Die Mixer Margarita Madness® Elite sind ausgestattet mit 3 verschiedenen Kontrollen: Mechanisch, Elektronisch oder Elektronisch mit Timerfunktion.



Ref. CAC1061

MMB145CE / MMB150CE / MMB160CE

Batidora de vaso Margarita Madness® Elite / Margarita Madness® Elite Series Blenders / Blenders Margarita Madness® Elite / Mixer der Serie Margarita Madness® Elite

Robusto motor de 2 HP/1490W, con dos velocidades. ¡Capaz de preparar 3 Margaritas de 455 ml en 8 segundos o menos!

MMB145CE – Controles mecánicos clásicos
MMB150CE – Controles electrónicos fáciles de limpiar

MMB160CE – Controles electrónicos con temporizador de cuenta regresiva de 60 segundos

Jarra apilable de copoliéster sin bisfenol A (BPA) de 1.4 L

Duradero acoplamiento de eje de acero

inoxidable, reemplazable por el usuario

Controles de ALTO/BAJO/APAGADO y PULSO

Garantía limitada de un año

Homologado CE y RoHS

High-performance 2 HP/1490W, 2-speed motor. Three 16-oz. margaritas in 8 seconds or less!

MMB145CE – classic toggle switch design
MMB150CE – easy-to-clean electronic keypad
MMB160CE – electronic keypad with 60-second countdown timer

1.4L stackable BPA-free copolyester container

Durable stainless steel user-replaceable drive coupling

HI/LO/STOP and PULSE controls

Limited One Year Warranty

CE, RoHS

Moteur haute performance de 2 HP/1490W, à deux vitesses. Permet de préparer 3 Margaritas de 455 ml en 8 secondes ou moins !

MMB145CE – interrupteur à bascule
MMB150CE – contrôle électronique facile à nettoyer

MMB160CE – contrôle électronique avec minuteur de 60 secondes

Bol en copolyester sans BPA de 1,4 L, empilable

Coupleur en acier inoxydable, résistant et facilement remplaçable par l'utilisateur

Commandes HAUT/BAS/ARRÊT et PULSE

Garantie limitée d'un an

Homologué CE et RoHS

Robuster Motor HP/1490W, 2

Geschwindigkeiten. Fähig 3 Margaritas von 455 ml in 8 oder weniger Sekunden herzustellen!

MMB145CE – Klassischer Kontrollmechanismus
MMB150CE – elektronische Kontrolle einfach zu reinigen
MMB160CE – elektronische Kontrolle mit 60 Sekunden Countdown Timer

1,4 Liter Behälter aus Copolyester ohne Bisfenol A (BPA)

Zusammensetzbare Kupplungsachse aus langlebigem rostfreiem Stahl durch den Benutzer austauschbar

Funktionen HI/LO/STOP und PULSE

Garantie auf ein Jahr begrenzt

Zertifiziert mit CE, RoHS



REF	Lts	€	U
MMB145CE	1,40	564,70	1
MMB150CE	1,40	588,55	1
MMB160CE	1,40	640,75	1



22000 RPM - 1,4 A



Ref. BB25ES



Ref. BB25EP

BB25EP/BB25ES

Batidoras de vaso para cócteles básicas / Basic Bar Blenders /
Blenders de bar / Basis Cocktail Mixer

REF	V	W	Hz	€	U
BB25EP	230	0,5 HP / 370 W	50	255,10	1
BB25ES	230	0,5 HP / 370 W	50	290,80	1

2 velocidades.

BB25EP: Jarra copoliéster.

BB25ES: Jarra de acero inoxidable.

2 speeds.

BB25EP: Copolyester container.

BB25ES: St/Steel container

2 vitesses.

BB25EP: Bol en copolyester.

BB25ES: Bol en acier inoxydable.

2 geschwindigkeiten.

BB25EP: Behälter aus copolyester.

BB25ES: Behälter aus rostfreiem Stahl.



Ref. CAC29



Ref. CAC37

CAC29/CAC37

Jarras / Containers / Bols / Karaffen

REF	Lts	€	U
CAC29	1,40	95,00	1
CAC37	1,00	137,05	1

28000 RPM - 1,4 A



CBL10



Tapa para líquidos calientes.
Hot blending lid.
Couvercle pour liquides chauds.
Deckel für heisse Flüssigkeiten.

CB15VE

Batidora de vaso 4 litros / 4-Liter food blender /
Bol mixeur 4 litres / Standmixer mit 4 Liter Behälter

REF	Lts	V	W	Hz	€	U
CB15VE	4,0	230	3,75 HP / 2800W	50	2.312,80	1
CAC72	Jarra / Container / Bol / Behälter					1
CBL10						1

Jarra de acero inoxidable con asas y tapa de caucho.

Cojinete amortiguador de una pieza, apto para lavavajillas.

Controles de velocidad variable (no se muestra).

Stainless steel container with two handles and rubberized lid.

Dishwasher-safe one-piece jar pad for easy cleaning.

Variable speed controls (not shown).

Bol en acier inoxydable avec anses et couvercle caoutchouté.

Coussin amortisseur d'une pièce, compatible lave-vaisselle.

Contrôle de vitesse variable (non représenté).

Behälter und Griffe aus rostfreiem Stahl und Deckel aus Kautschuk.

Stossdämpfereinheit aus einem Stück für Spülmaschinen geeignet.

Variable Geschwindigkeitskontrolle (nicht gezeigt).



Con potencia máxima de hasta 3½ HP/2600W, las batidoras de vaso de alta potencia de la serie Xtreme de Waring Commercial dan una potente ventaja a cualquier negocio. Logran impecables resultados y ofrecen mayor versatilidad, gracias a características únicas como temporizador integrado y velocidad variable hasta 30 000+ RPM. Con duraderas jarras de acero inoxidable o copoliéster sin bisfenol A (BPA) y controles electrónicos o mecánicos fáciles de usar, son perfectas para todas sus tareas de preparación de bebidas y alimentos.

Waring Commercial heavy-duty 3½ peak HP/2600W Blenders give every commercial environment a high-powered advantage. With 30,000+ RPM and models with built-in timers and variable speeds, these high-performance blenders produce flawless results every time. The durable BPA-free copolyester or stainless steel containers with simple touchpads or toggles are perfect for anything from food prep to smoothies!

Les blenders de la gamme Xtreme, équipés de moteurs de 3½ HP/2600W, sont un atout de taille pour les professionnels de la restauration. Dotés de caractéristiques uniques (moteurs à vitesse variable de 30.000+ tr/mn, minuteur sur certains modèles), ces puissants appareils permettent de toujours obtenir des résultats optimaux. Équipés de bols en copolyester sans PBA ou en acier inoxydable et de contrôles électroniques ou interrupteurs à bascule, ils sont parfaits pour toutes les tâches de préparation d'aliments et de boissons.

Mit der Höchstleistung von bis zu 3½ HP/2600W, geben die Xtreme Hochleistungsstandmixer von Waring Commercial jedem Geschäft einen aussagekräftigen Vorteil.

Sie bieten unschlagbare Ergebnisse und eine hohe Vielseitigkeit, dank seiner einzigartigen Eigenschaften mit einem integrierten Timer und einer regulierbaren Geschwindigkeit von bis zu 300.000+ U/min. Mit langlebigen Behältern aus Edelstahl oder Copolyester ohne Bisphenol A (BPA) und einer elektronischen oder mechanischen Kontrolle für die einfache Handhabung, eignen sie sich perfekt für alle Aufgaben der Getränke und Lebensmittelzubereitung.

ROBUSTO MOTOR DE 3½ HP/2600W
VELOCIDAD SUPERIOR A 30 000 RPM COJINETE
AMORTIGUADOR DE UNA PIEZA,
EXTRAIBLE Y APTO PARA LAVAVAJILLAS

HEAVY-DUTY 3.5 PEAK/2600W HP MOTOR BLADE
SPEED OF OVER 30,000 RPM
ONE-PIECE DISHWASHER-SAFE
REMOVABLE JAR PAD

MOTEUR HAUTE PERFORMANCE DE 3½
HP/2600W VITESSE SUPÉRIEURE À 30 000 TR/
MN COUSSIN AMORTISSEUR D'UNE PIÈCE,
AMOVIBLE ET COMPATIBLE LAVE-VAISSELLE

ROBUSTER MOTOR 3½ HP/2600W
HÖCHSTGESCHWINDIGKEIT ÜBER 30 000 U/MIN
STOSSDÄMPEREINHEIT AUS EINEM STÜCK
AUSTAUSCHBAR UND SPÜLMASCHINEN
GEEIGNET



BATIDORAS PARA ALIMENTOS & CÓCTELES / FOOD & BAR BLENDERS / BOLS MIXEURS / ESSENS- U. GETRÄNKEMIXER

Cojinete amortiguado de una sola pieza extraíble y apto para lavavajillas.
One-piece dishwasher-safe removable jar pad.
Coussin amortisseur d'une pièce, amovible et compatible lave-vaisselle.
Stossdämpereinheit aus einem Stück.



30000 RPM



MX1000XTXEE / MX1000XTPEE

REF	Lts	W	€	U
MX1000XTXEE	2,00	3,5 HP / 2600 W	934,55	1
MX1000XTPEE	1,40	3,5 HP / 2600 W	934,55	1

Sencillos controles mecánicos:
ALTO/BAJO/APAGADO y PULSO.

Interrupteurs à bascule HAUT/
BAS/ARRÊT et PULSE.

Simple HIGH, LOW, OFF and
PULSE paddle switches.

Einfache mechanische Kontrolle:
HIGH, LOW, OFF und PULSE.



45000 RPM



MX1100XTXSEE / MX1100XTPSEE

REF	Lts	W	€	U
MX1100XTXSEE	2,00	3,5 HP / 2600 W	1.129,50	1
MX1100XTPSEE	1,40	3,5 HP / 2600 W	1.129,50	1

Controles electrónicos fáciles de
limpiar con funciones de
ENCENDIDO/APAGADO, ALTO,
BAJO, PAUSA y PULSO
Temporizador electrónico de
cuenta regresiva de 30 segundos
Con recinto insonorización

Contrôle électronique facile à
nettoyer avec boutons
MARCHÉ/ARRÊT, HAUT, BAS,
PAUSE et PULSE
Minuteur électronique de 30
secondes
Avec système d'insonorisation

Easy-to-clean electronic
membrane keypad with simple
ON/OFF, HIGH, LOW, STOP and
PULSE controls
30-second electronic countdown
timer
With sound enclosure

Elektronische Kontrolle einfach zu
reinigen mit Funktionen ON/OFF,
HIGH, LOW, STOP und PULSE.
Elektronischer Timer mit 30
Sekunden Countdown Funktion.
Gehäuse mit Geräuschisolierung



45000 RPM



MX1500XTXSEE / MX1500XTPSEE

REF	Lts	W	€	U
MX1500XTXSEE	2,00	3,5 HP / 2600 W	1.331,65	1
MX1500XTPSEE	1,40	3,5 HP / 2600 W	1.331,65	1

4 botones programables para
preparar bebidas
Pantalla LCD con retroiluminación
azul, para mayor comodidad
Contador de bebidas con total y total
diario
Velocidad variable
Función de pulso con control de
velocidad programable
Con recinto de insonorización.

Quatre boutons programmables pour la
préparation
des boissons
Écran numérique avec rétro-éclairage
Compteur qui affiche le total de
préparations du jour et le grand total
Vitesse variable
Double fonction PULSE avec vitesse
programmable
Avec système d'insonorisation.

4 reprogrammable beverage stations
LCD display with blue backlight for
easy viewing and program selection
Daily and total drink counter display
Adjustable speed controls
Dual PULSE feature with
reprogrammable speed control.
With sound enclosure.

Station mit 4 programmierbaren
Knöpfen zur Getränkezubereitung.
LCD Display mit blauer Beleuchtung,
für die einfache Handhabung.
Gesamt- und Tageseinheitenzähler.
Variable Geschwindigkeit
PULSE Funktion mit
programmierbarer Geschwindigkeit.
Gehäuse mit Geräuschisolierung.

BATIDORAS PARA ALIMENTOS & CÓCTELES / FOOD & BAR BLENDERS / BOLS MIXEURS / ESSENS- U. GETRÄNKEMIXER



20000 RPM



MX1200TXEE

Batidora de vaso de alta potencia con velocidad variable /
 Hi-Power Variable Speed Blender /
 Blender haute puissance à vitesse variable /
 Hochleistungsstandmixer mit variabler Geschwindigkeit

REF	Lts	W	€	U
MX1200TXEE	2,00	3,5 HP / 2600 W	1.064,60	1

Cojinete amortiguador de una pieza, extraíble y apto para lavavajillas. Garantía limitada de tres años (motor) y dos años (materiales y mano de obra). Jarras y recintos de insonorización disponibles.

One-piece dishwasher-safe removable jar pad. Limited three year motor and two year parts and labor warranty. All units available with the following jars and sound enclosures.

Coussin amortisseur d'une pièce, amovible et compatible lave-vaisselle. Garantie limitée de 3 ans (moteur) et deux ans (pièces et main d'œuvre). Bols et systèmes d'insonorisation disponibles.

Stossdämpfereinheit aus einem Stück, austauschbar und spülmaschinene geeignet. 3 Jahres Garantie (Motor) und 2 Jahre auf Material und Funktion. Behälter und Gehäuse mit Geräuschisolierung erhältlich.



Ideal para amasar masa de pan, montar claras, licuar sopas y batidos y mucho más.
 Ideal for whipped egg whites, soups, smoothies and everything in between.
 Idéal pour pain aux blancs d'œufs en neige, soupes, milk-shakes et plus encore.
 Ideal für durchzuführen, Durchkneten von Teigmassen, Eiweiss schlagen, Suppen verflüssigen, Mischen und vieles mehr.



CAC95I
 Jarra de copoliéster sin bisfenol A (BPA) de 2 L
 2 L. BPA-free copolyester jar
 Bol en copolyester sans BPA de 2 L
 2 l. Behälter aus Copolyester ohne BPA

REF	€	U
CAC95I	337,80	1



CAC93XI
 Jarra de copoliéster sin bisfenol A (BPA) de 1.4 L
 1,4 L BPA-free copolyester jar
 Bol en copolyester sans BPA de 1,4 L
 1,4 l. Behälter aus Copolyester ohne BPA

REF	€	U
CAC93XI	225,90	1



CAC90I
 Jarra de acero inoxidable de 2 L
 2 L stainless steel jar
 Bol en acier inoxydable de 2 L
 2 l. Behälter aus Edelstahl

REF	€	U
CAC90I	225,90	1



SE1000
 Compatible con todas las batidoras de vaso Waring® Commercial Xtreme de 2 L
 Commercial Xtreme. Retrofits all blenders in Waring® Commercial Xtreme Series - 2 L containers
 Compatible avec tous les blenders de 2 L de la gamme Waring® Commercial Xtreme
 Geeignet für alle 2 l. Standmixer Waring® Commercial Xtreme.

REF	€	U
SE1000	291,30	1



SE500
 Compatible con todas las batidoras de vaso Waring® Commercial Xtreme de 1.4 L
 Retrofits all blenders in Waring® Commercial Xtreme Series - 1,4 L containers
 Compatible avec tous les blenders 1,4 L de la gamme Waring® Commercial Xtreme.
 Geeignet für alle 1,4 l. Standmixer Waring® Commercial Xtreme.

REF	€	U
SE500	267,45	1

BATIDORAS PARA ALIMENTOS & CÓCTELES / FOOD & BAR BLENDERS / BOLS MIXEURS / ESSENS- U. GETRÄNKEMIXER



UNA BATIDORA DE VASO PARA CADA NECESIDAD /
A BLENDER FOR EVERY NEED /
UN BLENDER POUR TOUS LES BESOINS /
EIN STANDMIXER FÜR JEDES BEDÜRFNIS



NuBlend™

Margarita
Margarita
Madness
Margarita

X

Batidoras de vaso para cócteles
Bar Blenders
Blenders de bar
Barcocktailstandmixer

Batidoras de vaso profesionales
NuBlend Commercial Blenders
Blenders professionnels NuBlend
NuBlend professioneller
Standmixer

Margarita
Madness
Margarita

Batidoras de vaso de servicio pesado
Heavy Duty Blenders
Blenders haute puissance
Hochleistungsstandmixer

Batidoras de vaso de 4 L
4-Liter Food Blenders
Blenders de 4 L
4 Liter Standmixer

BEBIDAS POR DÍA / DRINKS PER DAY / BOISSONS - JOUR / GETRÄNKE PRO TAG

1 - 24

25 - 49

50 - 74

75 +

100 +

USO Y SERVICIO / USAGE AND APPLICATION TYPE / UTILISATION / GEBRAUCH UND EINSATZMÖGLICHKEIT

Preparación de bebidas Servicio ligero a mediano	Preparación de alimentos y bebidas Servicio ligero a mediano	Preparación de alimentos y bebidas Servicio mediano a pesado	Preparación de bebidas y alimentos Servicio pesado	Preparación de alimentos Servicio pesado
Light to Medium Beverage Prep	Light to Medium Food and Beverage Prep	Medium to Heavy Food and Beverage Prep	Heavy Food and Beverage Prep	Heavy Food Prep
Préparation de boissons Usage léger à moyen	Préparation de boissons et culinaire, usage léger et moyen	Préparation de boissons et préparation culinaire Usage moyen à intensif	Préparation de boissons et préparation culinaire Usage intensif	Préparation culinaire Usage intensif
Zubereitung von Getränken Gering- oder Mittelgebrauch	Zubereitung von Lebensmittel und Getränken Gering- oder Mittelgebrauch	Zubereitung von Lebensmittel und Getränken Mittel- und Vielgebrauch	Zubereitung von Lebensmittel und Getränken Vielgebrauch	Zubereitung von Lebensmittel Vielgebrauch

IDEAL PARA / GREAT FOR USE IN / TYPES DE COMMERCE / IDEAL FÜR

Bares	Bares, restaurantes pequeños y heladerías	Bares, restaurantes y heladerías	Heladerías, cafeterías, restaurantes, bares, establecimientos de cuidado de la salud, escuelas, instituciones	Restaurantes grandes, establecimientos de cuidado de la salud, escuelas, instituciones
Bars	Bars, Small Restaurants, Smoothie Shops	Bars, Restaurants, Smoothie Shops	Smoothie Shops, Coffee Shops, Restaurants, Bars, Healthcare, Schools, Institutions	Large Restaurants, Healthcare, Schools, Institutions
Bars	Bars, petits restaurants, commerces de jus de fruits frais	Bars, restaurants, commerces de jus de fruits frais	Bars/Commerces de jus de fruit, salons de thé, restaurants, centres de remise en forme, établissements scolaires ou médicaux, institutions	Restaurants, brasseries, établissements scolaires ou médicaux, institutions
Bars	Bars, kleine Restaurants und Eisdielen	Bars, Restaurants und Eisdielen	Eisdielen, Bsitros, Restaurants, Bars, Wellnesseinrichtungen, Schulen, Institute	Grosse Restaurants, Wellnesseinrichtungen, Schulen, Institute

APLICACIONES RECOMENDADAS / RECOMMENDED APPLICATIONS / IDÉAL POUR LA PRÉPARATION DE / IDEAL FÜR DIE ZUBEREITUNG VON

Bebidas heladas, batidos de fruta, margaritas y mucho más	Cócteles helados, batidos de helado, salsas frías y calientes, aderezos y más	Margaritas, daiquiris, granitas, salsas, sopas y más	Batidos de fruta, bebidas de café helado, cócteles helados, salsas, aderezos, sopas, postres, aliños y mucho más	Aliños, salsas, aderezos, sopas y más
Frozen Drinks, Smoothies, Margaritas and More	Frozen Cocktails, Ice Cream Drinks, Dips, Salsas, Sauces and More	Margaritas, Daiquiris, Granitas, Sauces, Soups and more	Fruit Smoothies, Iced Coffee Drinks, Frozen Cocktails, Salsas, Sauces, Soups, Desserts, Dressings and more	Dressings, Salsas, Sauces, Soups and More
Milkshakes, boissons glacées, cocktails, Margaritas, etc.	Boissons glacées, milkshakes, cocktails, sauces, etc.	Margaritas, Daiquiris, Granitas, sauces, soupes, etc.	Smoothies, café glacé, cocktails glacés, sauce, crèmes, soupes, desserts, vinaigrettes, etc.	Vinaigrettes, sauces, crèmes, soupes, etc.
Gefrorene Getränke, Fruchtcocktails, Magaritas und vieles mehr	Eiscocktails, Eishakes, kalte und heisse Sossen, Dressings und vieles mehr	Magaritas, Daiquiris, Granitas, Sossen, Suppen und vieles mehr	Fruchtcocktails, gefrorene Kaffegetränke, Eiscocktails, Sossen, Nachtisch, Dressings und vieles mehr	Dressing, Sossen, Suppen und vieles mehr

MAQUINARIA /
MACHINERY /
MACHINES



Ref. WDM120E
16000 RPM



Ref. WDM240E
20000 RPM



Ref. WDM360E
25000 RPM



Ref. CAC20

INCLUYE VASOS DE ACERO INOXIDABLE /
INCLUDES STAINLESS STEEL MALT BEVERAGE CUPS /
INCLUT DES GOBELETS EN ACIER INOXYDABLE /
INKLUSIVE EDELSTAHLBEHÄLTER

WDM120E/WDM240E/WDM360E

Batidora para batidos / Drink Mixers /
Shaker électrique / Getränkemixer

REF	Lts	W	€	U
WDM120E	0,80	1 HP / 740 W	606,95	1
WDM240E	0,80	1 HP / 740 W	1.267,40	1
WDM360E	0,80	1 HP / 740 W	1.394,35	1

Incluye un agitador de aletas, un agitador macizo y un vaso de acero inoxidable.
Potente motor comercial, reemplazable por el usuario.

Includes solid and butterfly and removable agitator and stainless steel malt beverage cup.
Powerful, user-replaceable commercial motor.

Inclut un agitateur plein, un agitateur à ailettes et un gobelet en acier inoxydable.
Puissant moteur commercial remplaçable par l'utilisateur.

Inklusive Schmetterlingsmischer, massiver Mixer und Edelstahlbehälter.
Starker professioneller Motor durch den Benutzer austauschbar.

3600 RPM - 1,4 A



6001X

Licadora de servicio pesado / Heavy-Duty Juice Extractor /
Centrifugeuse à usage intensif / Hochleistungs Entsafter

REF	V	W	Hz	€	U
6001X	230	330	50	600,75	1

Cuchilla flotante de acero inoxidable, para extraer el zumo y eliminar la pulpa rápidamente.

Stainless steel blade speeds up juice flow with faster distribution of pulp.

Lame flottante en acier inoxydable qui extrait le jus rapidement, réduisant ainsi la quantité de pulpe.

Messer aus rostfreiem Stahl, zum schnellen Entsaften und Fruchtfleischentfernung.

8,00 - 10,00 L

Preparación máxima horaria / Maximum hourly preparation /
Préparation maximum horaire / Maximierte stündliche Zubereitung

BJX240

Exprimidora para bares / Bar Juicer / Presse-agrumes de bar / Fruchtpresse für Bars

0,5 A



REF	V	W	Hz	€	U
BJX240	230	110	50	284,75	1

Incluye un vaso de 1 L (no enseñado).
120 naranjas/h.

Inclut un récipient de 1 L pour servir le jus (non montré).
120 oranges/h.

Includes 1 L serving container (not shown).
120 oranges/h.

Inclusive 1 L Behälter (nicht gezeigt).
120 Orangen/h.

JX40CE

Exprimidora de servicio pesado / Heavy-Duty Citrus Juicer / Presse-agrumes à usage intensif / Hochleistungsfruchtpresse

620 W
1800 RPM



REF	€	U
JX40CE	833,75	1

Recolector de zumo de acero inoxidable, con ancho pico.
230V CA, 50 Hz, 2,7 A.

Récipient en acier inoxydable avec gros bec verseur.
230V C.A., 50 Hz, 2,7 A.

Stainless steel juice collector with large spout.
230 VAC, 50 Hz, 2.7 amps.

Edelstahl Saftkollektor mit breitem Ausguss.
230V CA, 50 Hz, 2,7 A.

WKS800E

Afilador de cuchillos comercial / Commercial Knife Sharpener

Aiguiseur électrique commercial / Kommerzieller Messerschärfer



REF	V	W	Hz	A	€	U
WKS800E	230	25	50/60	0,1	261,25	1

Dos ruedas de afilar (fino/grueso) y una rueda de pulir.
Afila a un ángulo de 18–22°, el ángulo recomendado por los fabricantes de cuchillos.

Deux meules d'affûtage (grains fins/grossiers) et une meule de polissage.
Aiguise à un angle de 18–22°, l'angle recommandé par les fabricants de couteaux.

La rueda de pulir gira en dirección opuesta para remover las asperidades en el filo del cuchillo de manera óptima y lograr un pulido más efectivo

La meule de polissage tourne dans les deux sens, pour un meilleur affilage.

Two grinding wheels (fine/coarse), one stropping wheel.
Grinds at 18–22° angles — optimum angles recommended by knife manufacturers.
Stropping wheel also operates in reverse direction, allowing for a more efficient removal of burrs and polishing of the blade.

Zwei Schärfräder (fein/grob) und ein Polierrad.
Schärfwinkel 18–22°, von den Messerhersteller empfohlen.
Das Polierrad dreht sich in der entgegengesetzten Richtung, um die Schärfrückstände optimal zu entfernen und um eine effiziente Polierung zu erreichen.

WSG30E Molinillo de especias profesional / Professional Electric Spice Grinder
Moulin à épices professionnel / Professionelle Gewürzmühle

19000 RPM - 0,76 A



Ref. CAC103



REF	V	W	Hz	Lts	€	U
WSG30E	230	175	50	0,40	236,35	1

Acción de pulso para controlar precisamente la consistencia de las especias. Incluye tres recipientes de acero inoxidable con tapas, aptos para lavavajillas.

Action intermittente, pour davantage de contrôle. Inclut trois récipients en acier inoxydable avec couvercles, compatibles lave-vaisselle.

PULSE actuation to easily manage consistency of grind. Includes 3 fully removable and dishwasher-safe stainless steel grinding bowls with convenient storage lids.

Pulsfunktion um die perfekte Konsistenz der Gewürze zu kontrollieren. Inklusive 3 Edelstahlbehälter mit Deckeln, spülmaschinengeeignet.

WSG60E Molinillo profesional - seco & húmedo / Professional grinder - dry & wet /
Moulin professionnel - sec & humide / Professionelle Mühle - trocken und feucht



25000 RPM - 3 A



REF	V	W	Hz	Lts	€	U
WSG60E	230	200	50	0,70	498,00	1

Carcasa de alta resistencia de aluminio de fundición. Incluye tres recipientes. Bloqueo de seguridad de la carcasa superior. Cuchillas de acero inoxidable durables. Incluye dos recipientes de acero inoxidable con tapas, aptos para lavavajillas.

Carcasse haute résistance en fonte d'aluminium. Muni de trois récipients. Blocage de sécurité de la carcasse supérieur. Lames en acier inoxydable durables. Muni de deux récipients en acier inoxydable à couvercles, va au lave-vaisselle.

High-strength aluminium casing. It includes three containers. Upper housing safety lock upper. Durable stainless steel blades. It includes two stainless steel containers with lids, dishwasher safe.

Strapazierfähiges Aluminiumgehäuse. Beinhaltet drei Behälter. Behälter mit leistungsfähigerem Sicherheitsverschluss. Haltbare Edelstahlklingen. Zwei Stahlbehälter mit Deckel, spülmaschinenfest sind eingeschlossen.

IDEA!

Perfecto para los granos de pimienta, canela, nueces, ajo, hierbas y otras mezclas secas y húmedas / Perfect for peppercorns, cinnamon, nuts, garlic, herbs, and other dry and wet blends / Parfait pour grains de poivre, cannelle, noix, ail, herbes et autres mélanges secs et humides / Perfekt für Pfefferkörner, Zimt, Walnüsse, Knoblauch, Kräutern und andere trockene und feuchte Mischungen

IC70E Triturador de hielo profesional / Professional ice crusher
Broyeur à glace professionnel / Professioneller Eiscrusher

0,22 Kg / min
13,6 Kg / h



REF	V	W	Hz	A	€	U
IC70E	240	0,5 HP / 240 W	50	1,5	236,35	1

Función START&STOP automática. Capacidad para 2.8 litros de hielo triturado. Admite sólo cubitos inferiores a 45 g.

Function START&STOP automatique. Bac à glace d'une capacité de 2,8 L. Pour des glaçons de moins de 45g.

Automatic START&STOP operation. Container holds up to 2.8 liters of crushed ice. Only admit ice cubes smaller than 45g.

Automatische START&STOP Funktion. Fassungsvermögen von 2,8 Liter gecrashtem Eis. Lässt nur Würfel bis zu 45g zu.



Freidoras equipadas con un termostato EGO, un termostato de seguridad, luces piloto indicadores y zona fría.

Las unidades de calentamiento se quitan y ponen fácilmente para facilitar la limpieza. Temperatura variable hasta 190 °C.

Las cubas llevan asas entrantes móviles (15070, 15071, 15000, 15001).

The deep fat fryers equipped with EGO thermostat, thermal cut-out, indicator lights, cold zone.

The heating unit is easily removable and thus facilitating maintenance and cleaning.

Variable temperature control up to 190 °C.

Removable inner pan with recessed handles (15070, 15071, 15000, 15001).

Les friteuses sont équipées d'un thermostat EGO, un thermostat de sécurité, des voyants lumineux et une zone froide.

Resistance amovible pour faciliter le nettoyage. Température variable jusqu'à 190 °C.

Les cuves, avec anses pliables, sont amovibles (15070, 15071, 15000, 15001).

Fritteuse hergestellt ausgestattet mit EGO-Thermostat, ein Sicherheitsthermostat, Kontrolllichter und kalte Zone.

Zur besseren Reinigung lassen sich die Hitzelemente einfach herausnehmen und zusammenbauen.

Variable Temperatur bis 190 °C.

Die Frittierkörbe werden mit abnehmbaren Griffen geliefert (15070, 15071, 15000, 15001).



FREIDORAS / FRYERS / FRITEUSES / FRITTEUSE

15070 Freidora 5 lts / 5 lts fryer / Friteuse 5 lts / 5 Liter Fritteuse

INOX - ST/STEEL
EDELSTAHL
18/10



REF	Lts	V	W	€	U
15070	5,00	230	2000	192,55	1

Medida cesta / Basket size / Mesure panier / Frittierkorbgröße 21 x 14 x 12,5 cm

15071 Freidora 5+5 lts / 5+5 lts fryer / Friteuse 5+5 lts / 5+5 Liter Fritteuse

INOX - ST/STEEL
EDELSTAHL
18/10



REF	Lts	V	W	€	U
15071	5,00+5,00	2 x 230	2 x 2000	388,95	1

Medida cesta / Basket size / Mesure panier / Frittierkorbgröße 21 x 14 x 12,5 cm

15000 Freidora 8 Lts / 8 Lts Fryer / Friteuse 8 Lts / 8 Liter Fritteuse

INOX - ST/STEEL
EDELSTAHL
18/10



REF	Lts	V	W	€	U
15000	8,00	230	3250	241,25	1

Medida cesta / Basket size / Mesure panier / Frittierkorbgröße 24 x 18 x 14 cm

15001 Freidora 8+8 Lts / 8+8 Lts Fryer / Friteuse 8+8 Lts / 8+8 Liter Fritteuse

INOX - ST/STEEL
EDELSTAHL
18/10



REF	Lts	V	W	€	U
15001	8,00+8,00	2 x 230	2 x 3250	486,70	1

Medida cesta / Basket size / Mesure panier / Frittierkorbgröße 24 x 18 x 14 cm

15002 Freidora 8 Lts con grifo de vaciado / 8 Lts fryer with drainage tap / Friteuse 8 Lts avec robinet vidange / 8 Liter Fritteuse mit Ablaufhahn

INOX - ST/STEEL
EDELSTAHL
18/10



REF	Lts	V	W	€	U
15002	8,00	230	3250	351,60	1

Medida cesta / Basket size / Mesure panier / Frittierkorbgröße 24 x 18 x 14 cm

15003 Freidora 8+8 LTS con grifo de vaciado / 8+8 Lts fryer with drainage tap / Friteuse 8+8 Lts avec robinet vidange / 8+8 Liter Fritteuse mit Ablaufhahn

INOX - ST/STEEL
EDELSTAHL
18/10



REF	Lts	V	W	€	U
15003	8,00+8,00	2 x 230	2 x 3250	609,25	1

Medida cesta / Basket size / Mesure panier / Frittierkorbgröße 24 x 18 x 14 cm





CAUTION - HOT SURFACES

WARING
COMMERCIAL

C-T-5

CONVEYOR TOASTING
SYSTEM

POWER ON

READY

ON

OFF

DARKEN

1 2 3 4 5

CONVEY

WARING

NSF
SUPPORTED

15042 / 15043 Tostadora continua / Conveyor toaster / Toasteur convoyeur / Durchlauf toaster

INOX - ST/STEEL
EDELSTAHL
18/10

REF	TIPO / TYPE	A x B x C cm	Cap. Max	V	W	€	U
15042	200	37 x 39 x 39	500 u/h	230	1940	896,60	1
15043	300	47 x 39 x 39	700 u/h	230	2640	1.192,95	1



El color de las tostadas puede determinarse por la velocidad de la banda transportadora, así como por las resistencias superior e inferior que se controlan independientemente. El aparato está completamente aislado para que emita un calor mínimo a su alrededor. El interruptor encendido-apagado contempla la posición extra de standby. La longitud de la banda transportadora permite 2 hileras de tostadas (tipo 200) y 3 hileras (tipo 300).

Toast colour can be determined by conveyor speed as well as by independently controlled heating elements. Units are fully insulated to emit only minimal heat to surroundings. Main switch with extra standby position. The toasters can be used for bread as well as for buns. The toasting belt is suitable for 2 rows for toast, 200 type and 3 rows, 300 type.

La couleur du pain se détermine par la vitesse de la bande de transport ainsi que par les résistances contrôlées indépendamment. Les appareils sont isolés entièrement et n'émettent qu'une chaleur minimale à la température ambiante. Interrupteur marche-arrêt qui inclut le mode veille standby. La Largeur de la bande de transport permet 2 rangées de tranches, type 200 et 3 rangées, type 300.

Die Farbe der Toasts kann durch die Geschwindigkeit des Laufbands bestimmt werden, sowie durch die oberen als auch durch die unteren Heizelementen, welche unabhängig von einander kontrolliert werden können. Das Gerät ist komplett isoliert um die Umgebungstemperatur minimal zu beeinflussen. Ein/ Aus Schalter mit extra Standby Position. Die Breite des Laufbands erlaubt 2 Toastreihen (Typ 200) y 3 Toastreihen (Typ 300).

CTS1000E Tostadora comercial de servicio pesado con transportador / Heavy-Duty Commercial Conveyor Toaster / Grille-pain à convoyeur à usage intensif / Kommerzieller Hochleistungs - Durchlauf toaster



REF	V	W	A	€	U
CTS1000E	230	2700	11,25	953,70	1



Pre-calentamiento ultra rápido de 5 minutos.
Ancha abertura de 5 cm para tostar rebanadas gruesas y panecillos.
Modo de espera para ahorrar energía.
Transportador con velocidad variable.
Permite tostar por una sola cara.

Ultra-fast, 5-minute heat-up time.
Large 5 cm opening accommodates thick breads and bagels.
Energy-saving standby function
Conveyor speed control to suit all toasting preferences.
Allows toasting on one side only.

Mise à température rapide (5 minutes).
Ouverture de 5 cm, pour les tranches épaisses.
Mode veille pour économiser de l'énergie.
Convoyeur à vitesse variable.
Permet de griller d'un seul côté.

Ultra schnelle Vorerhitzung von 5 Minuten. Öffnungshöhe von 5 cm zum Toasten von dicken Scheiben und Brötchen. Energiesparende Standby Funktion.
Laufband mit regulierbarer Geschwindigkeit.
Einseitiger Toaster.

15038 Tostadora / Sandwich toaster / Toasteur / Sandwichtoaster

INOX - ST/STEEL
EDELSTAHL
18/10



REF	V	W	€	U
15038	230	1700	253,50	1

Las resistencias se pueden controlar por separado. Con temporizador y bandeja limpieza recoge migas. 4 tubos de cuarzo.

Les résistances se contrôlent séparément. Avec minuterie, tiroir ramasse miettes et 4 tubes quartz.

Heating elements separately controllable. With timer, drip tray and 4 quartz heating elements.

Unabhängig steuerbare Hitzestäbe. Mit Timer und reinigbarer Krümelplatte, 4 Quarzrohre.

Se entregan con 3 pinzas para sandwich /
Delivered with 3 sandwich tongs /
Livrées avec 3 pinces à sandwich /
Lieferung mir 3 Sandwichzangen

15039 Tostadora / Sandwich toaster / Toasteur / Sanwichtoaster

INOX - ST/STEEL
EDELSTAHL
18/10



REF	V	W	€	U
15039	230	3000	290,40	1

2 niveles. Las resistencias funcionan por separado. Con temporizador, bandeja recoge migas. 6 tubos de cuarzo.

2 niveaux. Les résistances se contrôlent séparément. Avec minuterie, tiroir ramasse miettes et 6 tubes quartz.

2 levels. Heating elements separately controllable. With timer, drip tray and 6 quartz heating elements.

2 Ebenen. Unabhängig steuerbare Hitzestäbe. Mit Timer und reinigbarer Krümelplatte, 6 Quarzrohre.

Se entregan con 6 pinzas para sandwich /
Delivered with 6 sandwich tongs /
Livrées avec 6 pinces à sandwich /
Lieferung mir 6 Sandwichzangen

TOSTADORAS / TOASTERS / TOASTEURS / TOASTER

15040 / 15041 Tostadora / Toaster / Toasteur / Toaster



REF	RANURAS / SLOTS / FENTES / SCHLITZE	V	W	€	U
15040	4	230	2000	188,25	1
15041	6	230	3000	233,35	1

Ref. 15040



Fabricada en acero inoxidable. Con conmutador ahorro energía para decidir la cantidad de rebanadas a tostar. 2 ó 4 (ref.15040) / 3 ó 6 (ref.15041). Con temporizador. Ancho de ranura 2,5 cm.

Habillage en acier inoxydable. Avec commutateur économiseur pour choisir le nombre de tranches à griller: 2 ou 4 (ref. 15040) / 3 ou 6 (ref. 15041). Avec minuterie. Large fente 2,5 cm.

All St/Steel construction. With energy-saving switch to decide how many slices to toast. 2 or 4 (ref.15040) / 3 or 6 (ref.15041). With timer. Slot wide 2,5 cm.

Hergestellt aus rostfreiem Stahl. Mit energiesparendem Schalter um die Anzahl der zu toastenden Scheiben zu bestimmen. 2 oder 4 (Art.Nr.15040) / 3 oder 6 (Art. Nr.15041). Mit Timer. Schlitzbreite 2,5 cm.

Ref. 15041



WCT708E Tostadora de servicio mediano de 4 rebanadas / 4-Slice Medium-Duty Toaster / Grille-pain à usage moyen / 4 Scheiben Mittelleistungs Toaster



REF	RANURAS / SLOTS / FENTES / SCHLITZE	V	W	Hz	A	€	U
WCT708E	4	230	1800	50	7,8	246,95	1



Cuatro ranuras extra anchas de 3,5 cm. 225 rebanadas por hora. Con expulsión automática. Four extra-wide 3.5 cm slots, great for bagels. 225 slices per hour. With pop up system.

Quatre fentes extra-larges de 3,5 cm. Capacité de 225 tranches/heure. Avec éjection automatique. Vier Schieben extrabreit 3,5 cm. Automatischer Auswurf. 225 Scheiben pro Stunde.



GRILL DE CONTACTO / CONTACT GRILL / GRILL DE CONTACT / KONTAKTGRILL

Planchas de fundición.
 *Ranuras arriba y abajo.
 Tiempo de precalentamiento muy breve.
 Bandeja y recoge jugos.
 Borde antisalpicaduras.
 Luces piloto.
 Termostato ajustable hasta 300 °C.

Cast iron griddle plates.
 *Both plates with parallel grooves.
 Short warming-up time.
 Large drip tray.
 High turned-up spatter rim.
 Indicator lights.
 Adjustable thermostat to 300 °C.

Plaque en fonte.
 *Rainures en bas et en haut.
 Mise à température rapide.
 Tiroir de propreté.
 Bourdure anti projections haute.
 Voyants lumineux.
 Thermostat réglable jusqu'à 300 °C.

Grillplatten aus Gusseisen.
 *Rillen oben und unten.
 Sehr kurze Aufwärmzeit.
 Fettauffangsschale.
 Seiten mit Antispritzschutz.
 Kontrollleuchten.
 Einstellbares Thermostat bis 300 °C.



Ref. 818.000

Incluido en el precio / Included on the price /
 Inclus dans le prix / Inklusiv im Preis

15004

Grill de contacto "SOLO COMPACT" /
 "SOLO COMPACT" Contact grill /
 Grill de contact "SOLO COMPACT" /
 "SOLO COMPACT" Kontaktgrill



INOX - ST/STEEL
 EDELSTAHL
 18/10



REF	Superficie de cocción / Cooking surface / Surface de cuisson / Grillplattenfläche cm	V	W	€	U
15004*	22 x 23	230	1800	364,45	1

15007

Grill de contacto "DUETTO COMPACT" /
 "DUETTO COMPACT" Contact grill /
 Grill de contact "DUETTO COMPACT" /
 "DUETTO COMPACT" Kontaktgrill



INOX - ST/STEEL
 EDELSTAHL
 18/10



REF	Superficie de cocción / Cooking surface / Surface de cuisson / Grillplattenfläche cm	V	W	€	U
15007*	47 x 23	230	3600	593,65	1
15008	47 x 23	230	3600	593,65	1

15005
 15006

Grill de contacto "SOLO GRANDE" /
 "SOLO GRANDE" Contact grill /
 Grill de contact "SOLO GRANDE" /
 "SOLO GRANDE" Kontaktgrill



INOX - ST/STEEL
 EDELSTAHL
 18/10



REF	Superficie de cocción / Cooking surface / Surface de cuisson / Grillplattenfläche cm	V	W	€	U
15005*	32 x 21	230	2200	388,95	1
15006	32 x 21	230	2200	388,95	1

15009

Grill de contacto "DUETTO GRANDE" /
 "DUETTO GRANDE" Contact grill /
 Grill de contact "DUETTO GRANDE" /
 "DUETTO GRANDE" Kontaktgrill



INOX - ST/STEEL
 EDELSTAHL
 18/10



REF	Superficie de cocción / Cooking surface / Surface de cuisson / Grillplattenfläche cm	V	W	€	U
15009*	2 x (32 x 21)	2x230	2x2200	811,35	1

GRILL DE CONTACTO / CONTACT GRILL / GRILL DE CONTACT / KONTAKTGRILL

Placa superior articulada y auto-equilibrada, para acomodar piezas gruesas de hasta 7,5 cm.
Termostato ajustable hasta 300 °C.

Hinged self-balancing top plate to accommodate foods up to 7,5 cm thick.
Adjustable thermostat to 300 °C.

Charnière flottante qui s'adapte à l'épaisseur des aliments (jusqu'à 7,5 cm).
Thermostat réglable jusqu'à 300 °C.

Obere Grillplatte beweglich und selbsteinstellend, um sich dicken Stücken bis zu 7,5 cm selbst anzupassen.
Einstellbares Thermostat bis 300 °C.



Ref. CAC105

Incluido en el precio / Included on the price
Inclus dans le prix / Inklusiv im Preis

Parrilla/Sandwichera compacta /
Compact Panini Grill /
Grill/Presse-panini compact /
Kompakter Sandwichgrill

WPG150E



REF	Superficie de cocción / Cooking surface / Surface de cuisson / Grillplattenfläche cm	V	W	€	U
WPG150E	24 x 23,5	230	2000	494,40	1

Parrilla/Sandwichera grande /
Large Panini Grill /
Grand grill/presse-panini /
Grosser Sandwichgrill

WPG250E



REF	Superficie de cocción / Cooking surface / Surface de cuisson / Grillplattenfläche cm	V	W	€	U
WPG250E	37 x 28	230	2400	706,80	1

Borde antisplapicaduras alto.
Máximo aprovechamiento de la superficie de la plancha.
Termostato de la superficie con dos pilotos de control y bandeja recoge grasas incorporada.
Termostato ajustable hasta 300 °C.

High anti-splash upstand.
Two indicators lights, thermostat and build-in fat dripping tray.
Adjustable thermostat to 300 °C.

Avec bords anti-éclaboussement.
Profit maximum de la plaque.
Thermostat, deux voyants de contrôle et bac ramasse-graisse.
Thermostat réglable jusqu'à 300 °C.

Hohen Antipritzschutzeiten.
Maximale Nutzung der Grilläche.
Oberflächenthermostat mit zwei Kontrollleuchten und eingebauter Fettaufschale.
Einstellbares Thermostat bis 300 °C.

Plancha eléctrica lisa /
Electric griddle plain /
Plaque électrique unie /
Elektrische Grillplatte

15084



INOX - ST/STEEL
EDELSTAHL
18/10



REF	DIMENSIONES PLANCHA mm / DIMENSIONS GRIDDLE mm / DIM.SUPERFICE TRAVAIL mm / DIMENSIONEN GRILLFLÄCHE mm /	V	W	€	U
15084	400 x 400	230	3000	363,85	1

Plancha eléctrica 1/2 lisa - 1/2 ranurada /
Electric griddle 1/2 plain - 1/2 grooved /
Plaque électrique 1/2 unie - 1/2 rainurée /
Elektrische Grillplatte 1/2 glatt - 1/2 gerillt

15086



INOX - ST/STEEL
EDELSTAHL
18/10



REF	DIMENSIONES PLANCHA mm / DIMENSIONS GRIDDLE mm / DIM.SUPERFICE TRAVAIL mm / DIMENSIONEN GRILLFLÄCHE mm /	V	W	€	U
15086	400 x 400	230	3000	363,85	1

688085 Hervidor de arroz / Rice cooker / Cuiseur à riz / Reiskocher



REF	Ø cm	Lts	H	V	W	ARROZ / RICE / RIZ / REIS Kg	€	U
688.085	46	5,40	40	220-230/50Hz	1950	9,8	262,20	1
688.087	56	8,20	40	230/50Hz	2500	15	367,45	1



Ref: 688.085



Ref: 688.087

15036 Salamandra con parte superior regulable / Salamander with adjustable top / Salamandre hauteur réglable / Salamander mit regulierbarem Oberteil



INOX - ST/STEEL
EDELSTAHL
18/10



Ref	Grill cm	V	W	€	U
15036	44 x 33	230	3000	997,30	1

Con bandeja limpieza, rejilla cromada móvil y regulador de temperatura /

Avec tiroir de propreté, grille chromée amovible et régulateur de temperature

With dripping tray, heavy chrome-plated grid and adjustable temperature switch /

Mit Reinigungsblech, herausnehmbaren Chromrost und Temperaturregler.

15044 Máquina para cocer pasta con grifo de desagüe / Pasta cooker with drainage tap / Cuiseur à pâtes avec robinet vidange / Nudelkocher mit Ablaufhahn



REF	Lts	V	W	€	U
15044	25,00	230	3250	872,15	1

Con 3 cestas de malla fina: 1 de 145 x 280 x 175 (H) mm y 2 de 145 x 145 x 175 (H) mm.

Avec 3 corbeilles à mailles fines. 1-145 x 280 x 175 (H) mm et 2-145 x 145 x 175 (H) mm

With 3 fine mesh baskets, 1-145 x 280 x 175 (H) mm and 2-145 x 145 x 175 (H) mm

Mit 3 feinmaschigen Nudelsieben: 1-145 x 280 x 175 (H) mm und 2-145 x 145 x 175 (H) mm

PLACAS INDUCCIÓN / INDUCTION HOBBS / PLAQUES INDUCTION / INDUKTIONSFELDER



LAS PLACAS DE INDUCCIÓN OFRECEN MÁXIMA PRODUCTIVIDAD / INDUCTION HOBBS OFFER MAXIMUM PRODUCTIVITY / LES PLAQUES À INDUCTION OFFRENT UNE PRODUCTIVITÉ OPTIMALE / DIE INDUKTIONSFELDER BIETEN EINE MAXIMALE PRODUKTIVITÄT

ALTA VELOCIDAD DE COCCIÓN, Y UNA ALTA EFICIENCIA ENERGÉTICA / HIGH-SPEED COOKING AND HIGH ENERGY EFFICIENCY / GRANDE VITESSE DE CUISSON ET GRANDE EFFICACITÉ ÉNERGÉTIQUE / HOCHGESCHWINDIGKEITS KOCHEN UND HOHE ENERGIEEFFIZIENZ

MIENTRAS LAS COCINAS VITRO-CERÁMICAS TRADICIONALES CALIENTAN EL RECIPIENTE A TRAVÉS DE UNA RESISTENCIA ELÉCTRICA, LAS PLACAS DE INDUCCIÓN CREAN UN CAMPO ELECTROMAGNÉTICO QUE SE TRANSFORMA EN VIBRACIÓN Y ÉSTA EN CALOR. PARA ELLO, ES NECESARIO QUE EL RECIPIENTE ESTÉ PREPARADO PARA ACTIVAR LA VIBRACIÓN, POR ESO ES NECESARIO QUE SU BASE TENGA UNA PARTE MAGNÉTICA.

WHILE TRADITIONAL CERAMIC HOBBS HEAT THE COOKING VESSEL USING ELECTRICAL RESISTANCE, INDUCTION HOBBS CREATE AN ELECTRO-MAGNETIC FIELD WHICH IS TURNED INTO VIBRATION AND THUS INTO HEAT. TO DO THIS, THE PAN NEEDS TO BE ABLE TO ACTIVATE THE VIBRATION WHICH MEANS THAT THE BASE HAS TO BE PARTLY MAGNETIC.

ALORS QUE LES CUISINIÈRES VITROCÉRAMIQUE TRADITIONNELLES CHAUFFENT LE RÉCIPENT AU MOYEN D'UNE RÉSISTANCE ÉLECTRIQUE, LES PLAQUES À INDUCTION CRÉENT UN CHAMP MAGNÉTIQUE QUI SE TRANSFORME EN UNE VIBRATION QUI PAR LA SUITE GÉNÈRE CHALEUR. POUR CELA, IL FAUT QUE LE RÉCIPENT SOIT À MÊME D'ACTIVER LA VIBRATION, C'EST POURQUOI CELUI-CI DOIT DISPOSER D'UNE PARTIE MAGNÉTIQUE À LA BASE.

WÄHREND DIE TRADITIONELLEN KOCHFELDER DIE KOCHTÖPFE MIT HILFE EINER ELEKTRISCHEN WÄRMEQUELLE ERHITZEN, ERZEUGEN DIE INDUKTIONSFELDER EIN ELEKTROMAGNETISCHES FELD UND ERHITZEN DURCH VIBRATION. DAFÜR IST ES NÖTIG, DASS DIE ZU ERHITZENDEN BEHÄLTER FÜR DIE VIBRATION VORBEREITET SEIN MÜSSEN, D.H. SIE MÜSSEN EINEN ZUM TEIL MAGNETISCHEN UNTERBODEN HABEN.

CUERPO EN ACERO INOXIDABLE 18/10 /
COOKWARE BODY MADE OF 18/10 ST/STEEL /
LE CORPS EST EN ACIER INOXIDABLE 18/10 /
KÖRPER AUS EDELSTAHL 18/10

BASE APTA PARA INDUCCIÓN /
BASE FOR INDUCTION /
BASE POUR INDUCTION /
UNTERBODEN FÜR INDUKTION

CONTROLES DE TEMPERATURA INSTANTÁNEA /
INSTANT TEMPERATURE CONTROL /
CONTRÔLES DE TEMPÉRATURE INSTANTANÉE /
SEKUNDENSCHNELLE TEMPERATURKONTROLLE



MAQUINARIA /
MACHINERY /
MACHINES

Más seguridad: calor de placas residual, reduciendo lesiones y quemaduras /

Safer: the heat of the hob is residual, reducing injuries and burns /

Plus de sécurité : la chaleur de la plaque est résiduelle, ce qui réduit le risque de lésion et de brûlure /

Mehr Sicherheit: Die Kochfelder erzeugen nur Nachwärme, deshalb werden Verletzungen und Verbrennungen minimiert.

Más limpieza: facilidad de limpieza de las manchas porque no se pegan /

Cleaner: easier to clean up spills as food won't stick to the surface /

Plus de propreté : facilité de nettoyage des taches car les aliments n'accrochent pas /

Reinigung: Einfache Reinigung von Flecken, weil sie sich nicht festbrennen.



15078 Placa de inducción / Induction cooker / Plaque à induction / Induktionskochfeld



REF	Ø cm	V	HZ	W	€	U
15078	20	220-240	50	3500	314,60	1



Cuerpo en acero inoxidable.
Reloj temporizador (0-180 minutos).
Pantalla LED con control táctil.
Regulador de temperatura 1-10 (500-3500W).
Rango temperatura 60-240 °C.
Cuatro ventiladores de refrigeración.

Corps en acier inoxydable
Minuteur. Ecran LED (0-180 minutes). Tactile.
1-10 Niveau de puissance (500-3500W).
Températures: 60-240 °C.
Quatre ventilateurs.

St/steel housing.
Timer. LED display (0-180 minutes).
Touch control.
1-10 Power level (500-3500W).
Temperatures: 60-240 °C.
Four fans.

Gehäuse aus rostfreiem Stahl.
Timer. Timer (0-180 Minuten).
LED Display mit Touch control.
Temperaturregler 1-10 (500-3500W).
Temperaturbereich von 60-240 °C.
4 Kühlventilatoren.

15072 Placa de inducción / Induction cooker / Plaque à induction / Induktionskochfeld



REF	Ø cm	V	W	€	U
15072	25	230	3500	332,55	1



Cuerpo en acero inoxidable.
Mando digital de tiempo de 0-180 minutos.
Temperatura de 60-240 °C. Potencia de 500-3500 W. 2 Ventiladores.

Habillage en inox. Minuterie digitale de 0-180 minutes.
Température de 60-240 °C. Puissance: 500-3500 W. 2 Ventilateurs.

St/Steel housing. Digital regulation of time 0-180 minutes, thermostat 60-240 °C and power 500-3500 W. 2 Fans.

Gehäuse aus rostfreiem Stahl. Digitale Timersteuerung von 0-180 Minuten. Temperatur von 60-240 °C. Leistung von 500-3500 W. 2 Kühlventilatoren.

15079 Placa de inducción / Induction cooker / Plaque à induction / Induktionskochfeld



REF	Ø cm	V	Hz	W	€	U
15079	25	230	50	3500	269,15	1



Cuerpo en acero inoxidable
Reloj temporizador (0-180 minutos).
Pantalla LED.
Rango temperatura 60-240 °C.
Un ventiladores de refrigeración

Corps en acier inoxydable.
Minuteur. Ecran LED (0-180 minutes).
Températures: 60-240 °C.
Un ventilateur.

St/steel housing.
Timer. LED display (0-180 minutes).
Temperatures: 60-240 °C.
One fan.

Gehäuse aus rostfreiem Stahl.
Timer von 0-180 Minuten. LED Display.
Temperaturbereich von 60-240 °C.
1 Kühlventilator.

15077 Placa inducción PEQUEÑA / SMALL Induction cooker / Plaque induction PETITE / Kleines Induktionskochfeld



REF	Ø cm	V	Hz	W	€	U
15077	20	230	50/60	2000	125,90	1



Cuerpo en plástico. Con panel control táctil LCD.
Reloj temporizador (0-180 minutos).
Rango temperaturas: 60-240 °C.

Corps en plastic avec écran LCD tactile.
Minuteur (0-180 minutes).
Températures: 60-240 °C.

Plastic housing with touch control LCD panel.
Timer (0-180 minutes).
Temperatures: 60-240 °C.

Gehäuse aus Plastik. Touch Control LCD Bildschirm.
Timer (0-180 Minuten).
Temperaturbereich von 60-240 °C.

6881 Horno convección función vapor / Convection oven with steam function /
Four à air pulsé avec fonction vapeur / Konvektionsbackofen mit Dampfgarfunktion



REF	CAP.	V	W	€	U
688.150	4 x 2/3 GN	230	2500	870,40	1



Interruptor de selección para convección, vapor o combinación vapor/convección. Termostato max. 200°C. Reloj 120 minutos.

Bouton de réglage convection, vapeur or une combinaison de ces 2 systèmes. Fonction décongélation. Thermostat 200°C max. 120 minutes.

Switch for convection, steam or combination steam/convection and defrost function. Thermostat max. 200 °C. Timer 120 minutes.

Schalter für die Auswahl Konvektion, Dampf oder Kombination Dampf/Konvektion. Thermostat max. 200°C. Timer 120 Minuten.

15035 Horno multifuncional de convección / Convection oven / Four à air pulse / Multifunktioneller Konvektionsbackofen



REF	REJILLA / GRILL / GRILLE / ROST	V	W	€	U
15035	43 x 32	230	2670	663,50	1

4 rejillas incluidas / 4 grids included
4 grilles incluses / 4 Roste inklusive

Este horno de convección se distingue por un atractivo diseño y una fácil utilización. El exterior es de acero inoxidable y el interior esmaltado con iluminación. Temporizador, pilotos luminosos, termostato (max. 300 °C), termostato de seguridad y doble vidrio anti-quemaduras.

Four à air pulsé de design attráctif et facile à utiliser. Corps en acier inoxydable. Intérieur émaillé et illuminé. Avec minuterie, voyants lumineux, thermostat (max. 300 °C), thermostat de sécurité et avec double vitre.mostat, thermostat de sécurité et avec vitre double.

Convection oven is distinguished by an attractive design and easy operation. St/Steel outside, enameled oven inside with light, timer, indicator lights, thermostat, (max. 300 °C) thermal cut-out and double glass.

Dieser Konvektionsbackofen besticht durch sein attraktives Design und einer einfachen Bedienung. Das Aussengehäuse ist aus Edelstahl, innen ist er emailliert und beleuchtet. Timer, Kontrollleuchten, Thermostat (max. 300 °C), Sicherheitsthermostat und Doppelglas gegen Verbrennungen.

WC0500XE Horno de convección con capacidad de 42,5 Lts / Half-Size Convection oven 42,5 Lts
Four à convection commerciale de 42,5 Lts / 42,5 Liter Konvektionsbackofen

INOX - ST/STEEL
EDELSTAHL
18/10



REF	REJILLA / GRILL / GRILLE / ROST cm	V	W	Hz	A	Lts	€	U
WC0500XE	4 x (46 x 33)	220-240	1700	50	7,4	42,5	681,55	1
WC0500TR							149,65	1

Horneado por convección: asado, horneado y gratinado. Incluye una bandeja de acero inoxidable y tres rejillas de metal niquelado.

Cuisson au four, cuisson au four à convection, rôtisserie à la broche, grill. Inclut un plat de cuisson en acier inoxydable et trois grilles en acier chromé.

Convection bake, roast, bake and broil functions. Includes stainless steel baking sheet/drip pan and three nickel-plated baking racks.

Konvektionsbacken, Braten, Backen und Gratinieren. Inklusive Backblech aus rostfreiem Stahl und 3 metallisch vernickelten Rosten.



Ref. WC0500TR

HORNOS Y MICRO-ONDAS / OVENS & MICRO-WAVES /
FOURS ET MICRO-ONDES / BACKÖFEN UND MIKROWELLEN

688 Microondas profesional "magnetron" / "magnetron" professional micro-waves /
Four micro-ondes professionnel "magnetron" / Professionelle "magnetron" Mikrowelle



OUTPUT 1800 W

REF	Lts	Kg	Dim int / Inner sizes / Dim. int. / Innenmasse cm	V	W	€	U
688.010	30,00	35	37 x 36 x 19	230	2800	999,90	1



**2 magnetrones / 2 magnetrons /
2 magnétrons / 2 Magnetrones**

Horno microondas de acero inoxidable con 10 programas distintos. Tres velocidades y descongelación. Fuente cerámica + bandeja intermedia de 39x37 cm.

Four micro-ondes tout en acier inoxydable avec fonctions touches, 10 possibilités de programmation, 3 puissances et décongélation, plaque céramique + plaque intermédiaire 39x37 cm.

Microwave oven made of all St/Steel. 10 program options and defrost system. With ceramic plate and tray of 39x37 cm.

Mikrowellenofen aus rostfreiem Stahl mit 10 verschiedenen Programmen. Drei Geschwindigkeiten und Auftauen. Keramische Platte + Zwischentablett von 39x37 cm.

15080 Microondas combi / combi micro-wave / Four micro-ondes / Kombi - Mikrowelle



REF	Lts	Dim int / Inner sizes / Dim. int. / Innenmasse cm	V	Max W	€	U
15080	23,0	31,5 x 31,5 x 19	230	2400	256,30	1



Output / Ausgangsleistung: 800 W
Grill: 1200 W
Convección / Convection / Konvektion: 1200 W

Ø plato giratorio / glass round dish /
Plateau tournant / Drehplatte 27 cm

Funciones: descongelar, gratinar y calentar
Functions: defrosting, baking and heating
Fonctions: décongeler, gratter et chauffer
Funktionen: Auftauen, überbacken und erhitzen

Baño maría 1/1 gastronorm / Bain-marie 1/1 gastronorm / Bain-marie 1/1 gastronorme / Wasserbad 1/1 Gastronorm



Termostato / Thermostat / Thermostat / Thermostat :
Temp. Max 90 °C

+30 °C
+90 °C



REF	Tipo / Type	V	W	€	U
15014	A	230	1200	195,25	1
15015	B	230	1200	245,00	1
15016	C	230	1200	260,15	1
15017	D	230	1200	275,80	1
15018	E	230	1200	259,85	1
15019	F	230	1200	274,75	1
15060	G	230	1200	230,10	1

Baño maría 1/1 Gastronorm de doble pared de acero inoxidable, sin soldadura y fácil limpieza. Para recipientes gastronorm de una profundidad de hasta 150 mm. Termostato regulable, luz piloto y resistencia interior encastada.

Bain-marie 1/1 Gastronorm inox à double paroi. Cuve emboutie, sans soudures et facile a nettoyer. Pour bacs gastronormes profondeur jusqu'à 150 mm. Thermostat réglable, voyant lumineux et résistance encastrée.

Bain-marie 1/1 Gastronorm. Double walled St/Steel. Deep drawn, easy-clean, seamless waterpan. For GN pans max. depth 150 mm. Adjustable thermostat, indicator light and built-in elements.

Wasserbad 1/1 Gastronorm, Doppelwand aus rostfreiem Stahl ohne Verschweissung, einfach zu reinigen. Für Gastronormbehälter bis zu einer Tiefe von 150 mm. Regulierbares Thermostat, Kontrollleuchten und eingebauten Heizstäben.

Baño maría 1/1 gastronorm con grifo desagüe / Bain-marie 1/1 gastronorm with drainage tap / Bain-marie 1/1 gastronorme avec robinet de vidange / Wasserbad 1/1 Gastronorm mit Ablaufhahn



Termostato / Thermostat / Thermostat / Thermostat :
Temp. Max 90 °C

+30 °C
+90 °C



REF	Tipo / Type	V	W	€	U
15020	A	230	1200	208,55	1
15021	B	230	1200	258,30	1
15022	C	230	1200	273,50	1
15023	D	230	1200	280,75	1
15024	E	230	1200	265,25	1
15025	F	230	1200	279,70	1
15061	G	230	1200	236,25	1

Baño maría 1/1 Gastronorm de doble pared de acero inoxidable, sin soldadura y fácil limpieza. Para recipientes gastronorm de una profundidad de hasta 150 mm. Termostato regulable, luz piloto y resistencia interior encastada.

Bain-marie 1/1 Gastronorm inox à double paroi. Cuve emboutie, sans soudures et facile a nettoyer. Pour bacs gastronormes profondeur jusqu'à 150 mm. Thermostat réglable, voyant lumineux et résistance encastrée.

Bain-marie 1/1 Gastronorm. Double walled St/Steel. Deep drawn, easy-clean, seamless waterpan. For GN pans max. depth 150 mm. Adjustable thermostat, indicator light and built-in elements.

Wasserbad 1/1 Gastronorm, Doppelwand aus rostfreiem Stahl ohne Verschweissung, einfach zu reinigen. Für Gastronorm Behälter bis zu einer Tiefe von 150 mm. Regulierbares Thermostat, Kontrollleuchten und eingebauten Heizstäben.

A	B	C	D	E	F	G
Sin cubetas Without bags Sans bacs Ohne Behälter		GN 1/1 150 mm - 20,2 Lts GN 1/2 150 mm - 9,70 Lts GN 1/3 150 mm - 5,80 Lts		GN 1/4 150 mm - 4,10 Lts GN 1/6 150 mm - 2,40 Lts		

Las tapas para las cubetas Gastronorm no están incluidas pero pueden suministrarse (con o sin agujero para cacillo).

Lids for Gastronorm containers are not included but they can be supplied (with or without groove for spoon).

Les couvercles pour les bacs Gastronorme ne sont pas inclus mais peuvent être fournis (avec ou sans encoche pour louche).

Die Deckel für die Gastronormbehälter sind nicht inklusive, können aber geliefert werden (mit oder ohne Schöpflöffelöffnung).

MAQUINARIA PARA CHOCOLATE / MACHINES FOR CHOCOLATE /
MACHINES POUR LE CHOCOLAT / MASCHINEN FÜR SCHOKOLADE

15096 Fuente Fondue chocolate / Chocolate fountain / Fontaine à chocolat / Schokoladenbrunnen

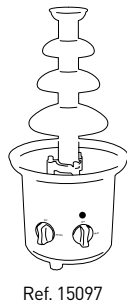
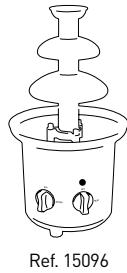

REF	ml	NIVELES / LEVELS / NIVEAUX / EBENEN	V	Hz	Ø cm	H cm	W	€	U
15096	700	3	230	50	21	38,0	250	69,00	1
15097	1200	4	230	50	23	45,0	250	85,05	1

Cuerpo y partes de acero inoxidable. Incorpora un regulador de temperatura y un regulador de velocidad. Muy fácil de desmontar y limpiar. Pie regulador para apoyo estable.

St/Steel body and parts. Temperature and speed control. Easy to clean. Adjustable foot for a stable standing.

Corps et composants en acier inoxydable. Regulateur température et vitesse. Très facile à nettoyer. Pied de régulation pour un appui stable.

Gehäuse und Teile aus rostfreiem Stahl. Eingebauter Temperatur- und Geschwindigkeitsregler. Einfach auseinander zu nehmen und zu reinigen. Regulierbarer Fuss für einen stabilen Stand.

15010 / 15011 Baño maría chocolate / Chocolate warmer /
Chauve-chocolat / Wasserbad



INOX - ST/STEEL
EDELSTAHL
18/10

Temp. Max 40 °C

REF	UNIDADES / UNITS / UNITÉS / EINHEIT	Lts	V	W	€	U
15010	1	4,50	230	165	376,60	1
15011	2	4,50 + 4,50	230	330	757,25	1



Especial chocolate
Special chocolate
Spécial chocolat
Spezial Schokolade

MAQUINARIA PARA CHOCOLATE / MACHINES FOR CHOCOLATE / MACHINES POUR LE CHOCOLAT / MASCHINEN FÜR SCHOKOLADE

WW180E / WW200E

Gofrera profesional / Heavy-duty waffle maker /
Gaufrier professionnelle / Professionelles Waffleisen



Ref. WW180E



Ref. WW200E

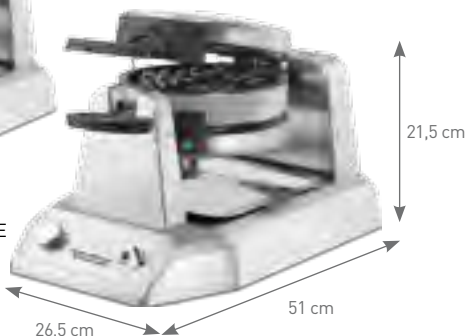

REF	Cap. Max	Tipo/Type	Ø cm	V	W	Hz	€	U
WW180E	25 u/h	sencilla/single	19,5	230	1200	50	435,50	1
WW200E	50 u/h	doble/double	19,5 x 2	230	1400	50	609,60	1

Moldes con triple capa antiadherente, para retirar fácilmente los gofres y limpiar rápidamente el aparato.

Plaques à triple revêtement antiadhésif, pour retirer facilement les gaufres et nettoyer rapidement.

Triple-coated nonstick plates allow for easy removal of waffle and quick cleanup.

Formen mit dreifacher Antihafbeschichtung, um die Waffeln einfach abzulösen und für eine einfache und schnelle Reinigung.

Máquina profesional para hacer conos de galleta /
Professional machine for making waffle cones /
Machine professionnelle pour faire des cônes en biscuit /
Gewerbliche Maschine zur Herstellung von Waffeltüten

WWCM180E



Ref. WWCMC121

REF	Cap. Max	TIPO/TYP	Ø cm	V	W	Hz	€	U
WWCM180E	60 u/h	sencilla/single	19	230	1200	50	685,00	1

Resistente base de fundición. Placas con triple capa antiadherente. Indicadores de "encendido", "listo para cocer" y "listo para comer".

Résistant base en fonte. Plaques à triple couche anti-adhérente. Voyants "allumage", "prêt à cuire" et "prêt à manger".

Durable cast-iron base. Plates with triple non-stick layer. "Power on", "ready to cook" and "ready to eat" indicators.

Solides Gusseisengestell. Dreifach-antihafbeschichtete Platten. Signalleuchten: "ein", "kochbereit" und "gar/essfertig".



15075 / 15076

Crêpera - Crêpera doble / Crêpe maker - double crêpe maker /
Crêpière - Crêpière double / Crêpe - Doppelcrêpeisen

Termostato / Thermostat / Thermostat / Thermostat :

Temp. Max 300 °C

Ref. 15075



Ref. 15076



REF	Ø cm	cm	V	W	€	U
15075	40	45 x 49	230	3000	606,20	1
15076	2 x 40	86 x 49	230	6000	1.114,70	1

Acero inoxidable con planchas de hierro fundido teflonadas. Indicador temperatura, cajón y espátula.

Acier inoxydable avec plaques en fonte avec revêtement en téflon. Témoin de controle, tiroir/plaque chauffante et étaleur de pâte.

St/Steel with cast iron teflon coated plates. Indicator light, drawer/warming tray and batter spreader.

Rostfreier Stahl und Platten aus Teflon- Gusseisen. Temperaturanzeige, Schublade und Spachtel.

ESPAÑOL

NUEVA GAMA DE CARROS CALIENTES PARA BANQUETES Y CATERING, QUE LE PERMITIRÁN ACERCAR LA COCINA ALLÍ DONDE ESTÉ EL CLIENTE, ASEGURANDO LA MÁXIMA CALIDAD Y LA ENTREGA DE LOS PLATOS POR ENCIMA DE LOS 65 °C.

ENGLISH

NEW RANGE OF HEATED TROLLEYS FOR BANQUETS AND OTHER CATERING EVENTS, A RANGE THAT ENABLES YOU TO TAKE THE KITCHEN TO CUSTOMER, GUARANTEEING MAXIMUM QUALITY AND THE DELIVERY OF DISHES AT TEMPERATURES ABOVE 65 °C.

FRANÇAIS

NOUVELLE GAMME DE CHARIOTS CHAUDS POUR BANQUETS ET SERVICE TRAITEUR (CATERING), POUR VOUS PERMETTRE DE RAPPROCHER LA CUISINE DU LIEU OÙ SE TROUVE LE CLIENT, EN GARANTISSANT LA QUALITE MAXIMALE ET LA LIVRAISON DES PLATS AU-DESSUS DE 65 °C.

DEUTSCH

NEUE PRODUKTPALETTE VON WARMHALTESCHRÄNKEN FÜR BANKETTS UND CATERING, UM DIE KÜCHE DEM KUNDEN ANZUNÄHERN, UM IHM EINE MAXIMALE QUALITÄT UND EINE SPEISENLIEFERUNG VON ÜBER 65 °C ZU VERSICHERN.

UNIFORMIDAD DE CIRCULACIÓN DEL AIRE CALIENTE / EVEN CIRCULATION OF HOT AIR / UNIFORMITÉ CIRCULATION AIR CHAUD / EINHEITLICHE HEISLUFTZIRKULATION

Circulación uniforme y constante del aire gracias a un sistema único que imposibilita el contacto de las cubetas con el fondo o las paredes.

The circulation of air is even and constant thanks to a unique system that makes it impossible for the containers to touch the cabinet base or sides.

La circulation d'air chaud est uniforme et constant grâce à un système unique qui empêche que les bacs touchent le fond ou les parois.

Einheitliche und konstante Heissluftzirkulation dank eines einzigartigen Systems, welches den Kontakt der Behälter mit den Böden oder Wänden unmöglich macht.



1

AISLAMIENTO EN LANA DE ROCA / ROCKWOOL INSULATION / ISOLATION EN LAINE DE ROCHE / ISOLIERUNG MIT STEINWOLLE

+ DURADERO

Aislamiento térmico en lana de roca evitando la deformación con el calor y ampliando la vida útil del armario.

+ AHORRO ENERGÉTICO

Gracias al extraordinario sistema de aislamiento, se consigue el grado de temperatura deseado, con mayor rapidez y permite conservar el calor durante un periodo de tiempo más prolongado.

+ HIGIÉNICO

Con el sistema de guías monobloc (sin soldaduras) la limpieza interior es mayor, más fácil y rápida.

+LONG LASTING

Thermal insulation provided by rockwool preventing deformation through heat and lengthening the useful life of the cabinet.

+ENERGY SAVING

Thanks to the extraordinary thermal insulation system, the desired temperature is achieved more quickly and the heat is conserved for longer periods.

+HYGIENE

With the exclusive system of monoblock guides (without welds) cleanliness inside is grater, easier and faster.

+DURABLE

Isolation thermique en laine de roche pour éviter la déformation par la chaleur et augmenter la vie utile de l'armoire.

+HYGIÉNIQUE

Grâce au système exclusif de glissières monobloc (sans soudures) le nettoyage intérieur est plus parfait, plus aisé et plus rapide.

+ÉCONOMIE D'ÉNERGIE

Grâce à l'extraordinaire système d'isolation thermique, la température souhaitée s'obtient plus rapidement et cela permet de conserver la chaleur pendant une plus longue période de temps.

+ LANGLEBIGKEIT

Hitzeisolierung durch Steinwolle, welche eine Hitzedeformierung ausschliesst und die Gebrauchsdauer verlängert.

+ ENERGIEERSPARNIS

Dank des aussergewöhnlichen Isolierungsystems lässt sich die gewünschte Temperatur schnell erreichen und sie wird für einen längeren Zeitraum beibehalten.

+ HYGIENE

Mit dem Einschubführungssystem Monoblock (ohne Verschweissungen) ist die Reinigung des Inneren besser, einfacher und schneller.

2

CAPACIDAD / CAPACITY / CAPACITÉ / KAPAZITÄT

Guías monobloc (sin soldaduras) para rejillas acero inoxidable y cubetas Gastronorm 2/1 y 1/1. Para platos hasta diámetro 31 cm.
 Monoblock guides (without welds) for St/Steel trays and Gastronorm containers 2/1 and 1/1. For dishes up to 31 cm diameter.
 Glissières monobloc (sans soudures) pour grilles acier inoxydable et bacs Gastronorm 2/1 et 1/1. Pour des assiettes jusqu'à 31 cm diamètre.
 Einschubführungen Monoblock (ohne Verschweissungen) für Roste aus rostfreiem Stahl und Gastronormbehälter 2/1 und 1/1. Für Teller bis zu einem Diameter 31 cm.

FÁCIL MANEJO / EASY HANDLING / MANUPULATION AISÉE / EINFACHE HANDHABUNG

Asas posteriores	Back side handles	Poignées postérieures	Griffe hinten
Ruedas pivotantes & 360°. Dos con freno	Rotating wheels 360°. Front wheels with brakes	Roues pivotantes 360°. Roues avant avec freins	Räder 360° drehbar. Zwei mit Bremsen.

3

BLOQUE CALÓRICO / HEAT BLOCK / BLOC CHAUFFANT / HITZEBLOCK

Extraíble sin necesidad de herramientas. Termostato regulador temperatura 0 °C a 100 °C. Recipiente humidificador integrado.	Extractable without the need of tools. Thermostat for regulation of temperature 0 °C to 100 °C. Provided with humidification container.	Amovible sans besoin d'outils. Thermostat régulateur de température 0 °C - 100 °C. Bac humidification intégré.	Auseinandernehmbar ohne den Bedarf von Werkzeugen. Regulierbares Thermostat von 0 °C a 100 °C. Integrierter Behälterluftbefeuchter.
--	---	--	---

810

Ref. 81000



Medidas Guías / Rails Dimensions / Dimensions Glissières / Einschubmasse	GN 2/1
Capacidad / Capacity / Capacité / Fassungsvermögen	10 GN 2/1 20 GN 1/1
Potencia / Potency / Puissance / Leistung	3000W
Tensión / Voltage / Voltage / Spannung	230 V II
Precio / Price / Prix / Preis	2.890,15 €

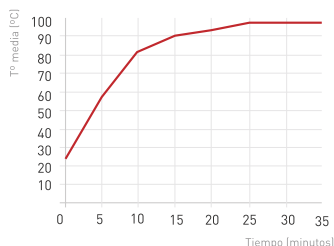

Ref. 81010



Medidas Guías / Rails Dimensions / Dimensions Glissières / Einschubmasse	GN 2/1
Capacidad / Capacity / Capacité / Fassungsvermögen	20 GN 2/1 40 GN 1/1
Potencia / Potency / Puissance / Leistung	3000W
Tensión / Voltage / Voltage / Spannung	230 V II
Precio / Price / Prix / Preis	3.745,90 €

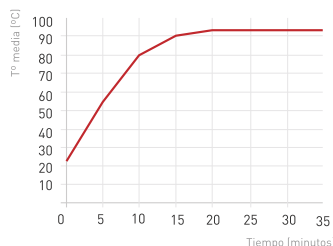

Ref. 81020



Medidas Guías / Rails Dimensions / Dimensions Glissières / Einschubmasse	GN 2/1
Capacidad / Capacity / Capacité / Fassungsvermögen	40 GN 2/1 80 GN 1/1
Potencia / Potency / Puissance / Leistung	4000W
Tensión / Voltage / Voltage / Spannung	230 V II
Precio / Price / Prix / Preis	5.376,65 €

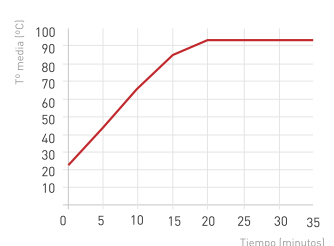

15026 / 15027 / 15028

Calentador de platos / Hot cupboards /
Chauffe-assiettes / Tellerwärmer

+35 °C
+85 °C

REF	CAPACIDAD PLATOS / CAPACITY PLATES / CAPACITÉ ASSIETTES / TELLERKAPAZITÄT	V	W	€	U
15026	30	230	400	496,65	1
15027	60	230	750	572,05	1
15028	120	230	1250	1.010,10	1

Ref. 15027



MEDIDAS INTERIORES / INNER SIZES /
MESURES INTERIEURES / INNENMASSE
41 x 38 x 66,5 cm

Ref. 15026



MEDIDAS INTERIORES / INNER SIZES /
MESURES INTERIEURES / INNENMASSE
33,5 x 37,5 x 38,5 cm

Ref. 15028



Calentadores de platos Cater Chef. Acero inoxidable, doble pared, completamente aislado térmicamente. Con termostato e interruptor con piloto de control. Estantes interiores regulables y extraíbles. Puertas con bisagras muy reforzadas. Diámetro máximo de los platos de 32 cm.

Hot cupboards. St/Steel, wholly insulated. With thermostat and switch with indicator light, removable and adjustable shelves. Door with heavy duty hinges. Diameter max. plates 32 cm.

Chauffe-assiettes. Inox, double paroi, entièrement calorifugée, avec thermostat et interrupteur avec voyant de contrôle, étagères ajustables et amovibles. Porte avec charnières très résistantes. Diamètre max. assiettes 32 cm.

Tellerwärmer Cater Chef aus rostfreiem Stahl, Doppelwändig, komplett wärmeisoliert. Mit Thermostat und Schalter mit Kontrollleuchten. Innere Einlegeböden regulierbar und herausnehmbar. Türen mit verstärkten Scharnieren. Max. Tellerdurchmesser 32 cm.

MEDIDAS INTERIORES / INNER SIZES /
MESURES INTERIEURES / INNENMASSE
70 x 35 x 80 cm

5080 Lámpara mantenimiento comida caliente con soporte mesa / Heat shade with table support /
Lampe chauffante avec support / Wärmelampe mit Tischständer



REF	cm	V	W	€	U
508.015	22 x 22 x 65	230	250	529,15	1

Lámpara adaptada para mantener caliente todos platos. Estructura compuesta de lámpara infrarojos con base en acero inoxidable. Bombilla roja (250 W) incluida en el precio.

Lampe adaptée pour maintenir au chaud tous vos plats. Structure composée par lampe infrarouge ave base en inoxydable. Livrée avec ampoule rouge (250 W).

Appliance adapted to heat and keep warm snacks and ready meals. Structure is composed by an infrared lamp with a stainless steel base. Delivered with red bulb (250 W).

Lampe geeignet zum Warmhalten von allen Speisen. Struktur zusammengebaut aus Infrarotbirne mit Gehäuse aus rostfreien Stahl. Rote Birne (250 W) im Preis inklusive.

6880 Lámpara mantenedora de comida caliente / Heat shade /
Abat-jour pour lampe chauffante / Wärmelampe

NUEVO MODELO /
NEW MODEL /
NOUVEAU MODÈLE /
NEUES MODELL



REF	Ø cm	V	€	U
688.045	23	230	141,95	1

Aluminio. Con interruptor. Se entrega sin lámpara. Cable extensible hasta 180 cm.

Aluminium avec interrupteur. Livraison sans ampoule. Avec cable extensible jusqu'à 180 cm.

Aluminium with on/off switch. Delivered without bulb. Cable with rise and fall mechanism upto 180 cm.

Aluminium. Mit Schalter. Lieferung ohne Birne. Auseinanderziehbares Kabel bis 180 cm.

15031 / 15032 Lámpara mantenedora de comida caliente / Heat shade with lamp /
Abat-jour pour lampe chauffante infra-rouge / Wärmelampe



REF. 15031

REF. 15032

REF	Ø cm	V	€	U
15031	23	230	204,50	1
15032	23	230	212,65	1

Cable fijo Se entrega con lámpara roja
Fixed cable Delivered with red bulb
Cable fixe Livraison avec ampoule rouge
Festes Kabel Lieferung mit roter Lampe



Aluminio o cobre. Con interruptor. Se pone en funcionamiento rápidamente y proporciona un calor penetrante sin solidificar la superficie de las salsas. Fácil de instalar. Se entrega con lámpara (250 W max). Versión con cable fijo.

Aluminium ou cuivre. Avec interrupteur. Mise en service rapide. Chaleur pénétrante sans coaguler la surface des sauces, etc. Facile à installer. Livraison avec ampoule (250 W max). Avec cable fixe.

Aluminium or copper. With on/off switch. It gives instant direct heat. Provides a penetrating heat without congealing surfaces, gravies, etc. Simple to install. Delivered with bulb (250 W max). Cable fixe.

Aluminium oder Kupfer. Mit Schalter. Schnelles Einschalten und verteilt eine durchdringende Wärme ohne die Oberfläche der Sossen zu verbrennen. Einfache Installierung. Lieferung mit Birne (250 W max). Mit festen Kabel.

LÁMPARAS CALENTADORAS / HEAT SHADE / LAMPE CHAUFFANTE / WÄRMELAMPEN

15029 / 15030 Lámpara mantenedora de comida caliente / Heat shade with lamp /
Abat-jour pour lampe chauffante infra-rouge / Wärmelampe

REF	Ø cm	V	€	U
15029	23	230	220,75	1
15030	23	230	237,15	1

Cable extensible
Rise&fall cable
Cable extensible
Festes Kabel

Se entrega con lámpara roja
Delivered with red bulb
Livraison avec ampoule rouge
Lieferung mit roter Lampe



Aluminio o cobre. Con interruptor. Se pone en funcionamiento rápidamente y proporciona un calor penetrante sin solidificar la superficie de las salsas. Fácil de instalar. Se entrega con lámpara (250 W max). Versión con cable de mecanismo extensible (máx. 140 cm).

Aluminium ou cuivre. Avec interrupteur. Mise en service rapide. Chaleur pénétrante sans coaguler la surface des sauces, etc. Facile à installer. Livraison avec ampoule (250 W max). Avec cable extensible (max. 140 cm).

Aluminium or copper. With on/off switch. It gives instant direct heat. Provides a penetrating heat without congealing surfaces, gravies, etc. Simple to install. Delivered with bulb (250 W max). Cable with rise and fall mechanism (max. 140 cm).

Aluminium oder Kupfer. Mit Schalter. Schnelles Einschalten und verteilt eine durchdringende Wärme ohne die Oberfläche der Sossen zu verbrennen. Einfache Installation. Lieferung mit Birne (250 W max). Mit ausziehbarem Kabel (máx. 140 cm).

15033 / 15034 Recambio lámparas / Bulb only / Ampoule seule / Ersatzbirnen



REF	COLOR / COLOUR / COULEUR / FARBE	W	€	U
15033	rojo / red / rouge / Rot	175	23,60	1
15034	blanco / white / blanc / Weiss	175	23,60	1
710.205	rojo / red / rouge / Rot	250	37,55	1
710.206	blanco / white / blanc / Weiss	250	37,55	1



962 Calentador de platos o bandejas / Hot tray warmer / Réchaud / Tablett- oder Tellerwarmhalter



REF	QUEMADORES / BURNERS / BRÛLEURS / BRENNER	mm	€	U
962.002	2	370 x 175 x 70	36,40	1
962.003	3	480 x 175 x 70	56,85	1

Inox con placa base de aluminio.
St/Steel with aluminium cover plate.
Inox avec plaque couvercle en aluminium.
Rostfreier Stahl mit Aluminium Basisplatte.

2 ó 3 quemadores.
2 or 3 burners.
2 ou 3 brûleurs.
2 oder 3 Brenner.

15073 / 15074 Placa caliente / Heating plate / Plaque chauffante / Heizplatte



REF	mm	V	W	€	U
15073	600 x 400	230	600	205,00	1
15074	530 x 325 (gastronorm 1/1)	230	600	188,25	1

Fabricada en acero inoxidable 18/10.
Termostato regulable hasta 75 °C.
Con interruptor central y piloto de control.



18/10 St/Steel. Adjustable thermostat up to 75 °C.
With on / off switch and indicator light.

Habillage en inox 18/10. Thermostat réglable jusqu'à 75 °C.
Interrupteur central et voyant de contrôle.

Hergestellt aus Edelstahl 18/10.
Thermostat regulierbar bis 75 °C.
Mit zentralem Schalter und Kontrollleuchten.

ARMARIOS BOTELLAS / CABINET FOR BOTTLES /
ARMOIRES CLIMATISATION BOUTEILLES / FLASCHENKLIMASCHRANK

ESPAÑOL

ENFRIADORES DE BOTELLAS DE VINO COLOR NEGRO EXTERIOR, CON PUERTA DE DOBLE CRISTAL AHUMADO. INCLUYEN TERMOSTATO, AUTO DESCONGELACIÓN AUTOMÁTICO, ILUMINACIÓN INTERIOR SUAVE Y PATAS NIVELADORAS. VENTILADOR DE REFRIGERACIÓN.

ENGLISH

BLACK COLOURED EXTERIOR CABINET FOR WINE BOTTLES WITH DOUBLE GLASSED (SHADED) DOOR, ADJUSTABLE THERMOSTAT FOR FULL TEMPERATURE CONTROL, AUTO DEFROST, SOFT INTERIOR LIGHTING, LEVELING FEET, FAN ASSISTED REFRIGERATION.

FRANÇAIS

ARMOIRE DE CLIMATISATION À VIN EN COULEUR NOIR EXTÉRIEUR, PORTE AVEC DOUBLE VITRAGE OMBRÉ, THERMOSTAT RÉGLABLE POUR CONTRÔLE TEMPÉRATURE. DÉGIVRAGE AUTOMATIQUE. ÉCLAIRAGE INTÉRIEUR ET PIEDS RÉGLABLES. VENTILATEUR DE REFRIGÉRATION.

DEUTSCH

WEINFLASCHENKLIMASCHRANK AUSSEN SCHWARZ, MIT GETÖNTER DOPPELGLATSÜR. INKLUSIVE THERMOSTAT, AUTOMATISCHE AUFTAUUNG, DEZENTE INNENBELEUCHTUNG UND EINSTELLBARE FÜSSE. KÜHLVENTILATOREN.

480 Armario reFrigeración botellas / Climatisation cabinet for wine bottles /
Armoire de climatisation à vin / Flaschenklimaschrank



Ref. 480.118

REF	Cap.	L	cm	V	W	€	U
480.118	18	52	49 x 35 x 66	230	70	226,30	1
480.028	28	80	52 x 45 x 73	230	130	300,00	1
480.018*	18	52	49 x 35 x 66	230	130	291,85	1
480.040*	40	110	53 x 54 x 88	230	160	600,15	1

* Zona dual de temperatura
Dual temperature zone
Zone de température double
Dual Temperaturzonen

REF	SUPERIOR / TOP / SUPÉRIEUR / OBEN °C	INFERIOR / BOTTOM / INFÉRIEUR / UNTEN °C
480.018	7 - 12	12 - 18
480.118		11 - 18
480.028		11 - 18
480.040	6 - 12	11 - 12



Ref. 480.028



Ref. 480.040



SERVICIO DE MESA Y BUFFET/ TABLE AND BUFFET SERVICE/SERVICE DE TABLE ET BUFFET/ TISCH- UND BUFFET-SERVICE

5.1 BUFFET Y PRESENTACIÓN / BUFFET AND PRESENTATION / BUFFET ET PRÉSENTATION / BUFFET UND PRÄSENTATION 236

CUBIC	236
VITRINAS / DISPLAY CABINETS / VITRINES / AUSLAGEVITRINE	263
UTENSILIOS BUFFET / BUFFET UTENSILS / USTENSILES BUFFET / BUFFETUTENSILIEN	264
PINZAS / TONGS / PINCES / ZANGEN	270
BANDEJAS PRESENTACIÓN / SERVING TRAYS / PLATEAUX DE SERVICE / SERVIERTABLETTS	272
BAÑO MARÍA / BAIN MARIE / BAIN-MARIE / WASSERBAD	274
CHAFING	276
BAMBÚ NATURAL & MADERA / NATURAL BAMBOO & WOOD / BAMBOU NATUREL & BOIS / NATURBAMBUS & HOLZ	280
CESTAS PRESENTACION / BASKETS / CORBEILLE / KÖRBE	282
MELAMINA / MELAMINE / MÉLAMINE/ MELAMIN	290

5.2 BAR 312

CUBETERA / WINE BUCKETS / SEAUX À CHAMPAGNE / KÜHLER	312
COMPLEMENTOS DE VINO / WINE COMPLEMENTS / ACCESSOIRES DU VIN / WEINZUBEHÖR	318
TETERA / TEA POT / THÉIÈRE / TEEKANNE	321
BANDEJA CAMARERO / ROUND SERVING TRAY / PLATEAU LIMONADIER / SERVICETABLETT	325
ALFOMBRAS CAUCHO / NATURAL RUBBER MATS / TAPIS EN CAOUTCHOUC / KAUTSCHUKMATTEN	326

5.3 SERVICIO DE MESA / TABLE TOP SERVICE / SERVICE DE TABLE / TISCHSERVICE 328

MANTEL INDIVIDUAL / PLACE MAT / SET DE TABLE / PLATZMATTE	328
MINIATURAS / MINIATURES / MINIATURES / MINIATUREN	330
PIZARRAS / SLATE TRAYS / ARDOISE / SCHIEFFERTAFELN	336
JARRA / SERVER / PICHET / KARAFFE	338
PORTAMENÚS / MENU HOLDER / PORTE-MENU / MENÜHALTER	346
CONSUMIBLES / DISPOSABLES / JETABLES / VERFÜGBAR	347

5.4 COLECTIVIDADES / INSTITUTIONS / COLLECTIVITÉS / KOLLEKTIVITÄT 352

CARROS Y DISPENSADORES / TROLLEYS & DISPENSERS / CHARIOT ET DISTRIBUTEURS / SERVICEWAGEN	352
SEÑALIZACIÓN / SIGNS / SIGNALISATION / MARKIERUNG	356

CUBIC[®] BY PUJADAS



**DESCUBRE LA MEJOR PRESENTACIÓN
DE BUFFET, PORQUE:**

ES ELEGANTE, ES ORIGINAL, AHORRA ESPACIO,
OFRECE MÚLTIPLES Y
VARIADAS COMBINACIONES.

**DISCOVER BEST BUFFET DISPLAY,
THANKS TO ITS:**

ELEGANCE, ORIGINALITY, SPACE SAVING PROPERTIES,
MULTI-COMBINATIONS.

EXCLUSIVE

PATENT PENDING



**DÉCOUVREZ LA MEILLEURE PRÉSENTATION BUFFET,
GRÂCE À SON:**

ÉLÉGANCE, ORIGINALITÉ, GAIN D'ESPACE,
MULTIPLES COMBINAISONS POSSIBLES.

**ENTDECKEN SIE DIE BESTE BUFFET-
PRÄSENTATION:**

ELEGANZ, ORIGINALITÄT, PLATZSPAREND,
VIELE VERSCHIEDENE
KOMBINATIONSMÖGLICHKEITEN

SERVICIO DE MESA Y BUFFET /
TABLE AND BUFFET SERVICE /
SERVICE DE TABLE ET BUFFET

Muebles presentación buffet / Display buffet cases /
Meubles présentation buffet / Buffet Präsentationsmöbel

ADAPTADO A MEDIDAS GASTRONORM /
SUITABLE FOR GASTRONORM SIZES /
ADAPTÉS AUX MESURES GASTRONORME /
GEEIGNET FÜR GASTRONORMGRÖSSEN



DOS COLORES DISPONIBLES:
BLANCO Y NEGRO /

TWO COLORS AVAILABLE:
WHITE AND BLACK /

DEUX COULEURS DISPONIBLES:
BLANC ET NOIR /

IN ZWEI FARBEN LIEFERBAR:
SCHWARZ UND WEISS

FABRICADOS EN MADERA CON TRATAMIENTO
HIDRÓFUGO ESPECIAL, DE FÁCIL LIMPIEZA /
MADE OF WOOD WITH SPECIAL WATERPROOF
TREATMENT, EASY TO CLEAN /

FABRIQUÉ EN BOIS AVEC UN TRAITEMENT
HYDROFUGE SPÉCIAL, FACILE À NETTOYER /
HERGESTELLT AUS HOLZ, SPEZIELL
WASSERABWEISEND BEHANDELT, EINFACH ZU
REINIGEN

Carro madera presentación buffet / Wooden buffet serving trolley /
Chariot buffet en bois présentation buffet / Buffetserverwagen aus Holz

ELEGANTE COMBINACIÓN DE MADERA Y ALUMINIO /
OUTSTANDING COMBINATION OF WOOD AND ALUMINIUM /
COMBINAISON ÉLÉGANTE EN BOIS ET EN ALUMINIUM /
ELEGANTE KOMBINATION AUS HOLZ UND ALUMINIUM



ADAPTADO A MEDIDAS
GASTRONORM /

SUITABLE FOR
GASTRONORM SIZES /
ADAPTÉS AUX MESURES
GASTRONORME /
GEEIGNET FÜR GASTRONORM-
GRÖSSEN

TRATAMIENTO HIDRÓFUGO
ESPECIAL, DE FÁCIL LIMPIEZA /

WOOD WITH SPECIAL
WATERPROOF TREATMENT,
EASY TO CLEAN /
BOIS AVEC UN TRAITEMENT
HYDROFUGE SPÉCIAL,
FACILE À NETTOYER /
SPEZIELLE WASSERABWEISENDE
BEHANDLUNG, EINFACH ZU REINGEN

POSIBILIDAD DE CONVERTIR EL CARRO
EXPOSITOR EN MESA DE PRESENTACIÓN /

POSSIBLE TRANSFORMATION FROM AN
EXPOSITOR TROLLEY TO A PRESENTATION TABLE /
POSSIBILITÉ DE CONVERTIR LE CHARIOT
D'EXPOSITION EN UNE TABLE DE PRÉSENTATION /
MÖGLICHKEIT DEN BUFFETWAGEN IN EINEN
PRÄSENTATIONSTISCH ZU VERWANDELN

EXCLUSIVE

PATENT PENDING

Cubo y estantes / Cubes & shelves /
Cubes et tablettes / Behälter und Regale



CUBO / CUBES / CUBES / BEHÄLTER

CON TAPA SUPERIOR TRANSFORMABLE EN MINI ESTANTE, APILABLES ENTRE SÍ, MÚLTIPLES COMBINACIONES POSIBLES, AHORRO DE ESPACIO DURANTE EL ALMACENAJE DE LAS PIEZAS, TRATAMIENTO HIDRÓFUGO ESPECIAL /

TOP COVER CONVERTIBLE ON MINI SHELF, STACKABLE, MULTICOMBINATIONS, SAVING SPACE WHEN STORING PARTS, SPECIAL WATERPROOF TREATMENT /

COUVERCLE TRANSFORMABLE EN MINI RAYON, EMPILABLES, MULTIPLES COMBINAISONS POSSIBLES, GAIN D'ESPACE POUR LE STOCKAGE DES COMPOSANTS, TRAITEMENT HYDROFUGE SPÉCIAL /

MIT DECKELOBERTEIL UMWANDELBAR IN EIN MINIREGAL, STAPELBAR, VIELE VERSCHIEDENE KOMBINATIONSMÖGLICHKEITEN, PLATZSPAREND BEI LAGERUNG DER TEILE, SPEZIELLE WASSERABWEISENDE BEHANDLUNG

ESTANTES /SHELVES / TABLETTEST / REGALE

TRES LONGITUDES: 50, 80 Y 100 CM, DOS PROFUNDIDADES: 18 Y 35 CM, MADERA INDEFORMABLE, DOS COLORES: BLANCO Y NEGRO. POSIBILIDAD DE COMBINACIÓN DE COLORES, TRATAMIENTO HIDRÓFUGO ESPECIAL /

THREE LENGTHS: 50, 80 AND 100 CM, TWO DEPTHS: 18 AND 35 CM, UNDEFORMABLE WOOD, TWO COLORS: WHITE AND BLACK. POSSIBILITY OF COLOR COMBINATIONS, SPECIAL WATERPROOF TREATMENT /

TROIS LONGUEURS: 50, 80 ET 100 CM, DEUX PROFONDEURS: 18 ET 35 CM, BOIS INDÉFORMABLE, DEUX COULEURS: BLANC ET NOIR. COMBINAISON DE COULEURS POSSIBLE, TRAITEMENT HYDROFUGE SPÉCIAL /

DREI LÄNGEN: 50, 80 UND 100 CM, ZWEI TIEFEN: 18 UND 35 CM, UNVERFORMBARES HOLZ, ZWEI FARBEN: WEISS UND SCHWARZ, MÖGLICHKEIT DER FARBENKOMBINIERUNG, SPEZIELLE WASSERABWEISENDE BEHANDLUNG

SERVICIO DE MESA Y BUFFET /
TABLE AND BUFFET SERVICE /
SERVICE DE TABLE ET BUFFET



UN BUFFET COMO NUNCA ANTES HABÍAS IMAGINADO /
A BUFFET DISPLAY YOU COULD NEVER HAVE DREAMT OF /
UN BUFFET COMME VOUS NE L'AVIEZ JAMAIS IMAGINÉ /
EIN BUFFET WIE SIE ES SICH FRÜHER NIE VORSTELLEN KONNTEN





SERVICIO DE MESA Y BUFFET /
TABLE AND BUFFET SERVICE /
SERVICE DE TABLE ET BUFFET

CUBIC[®]
BY PUJADAS

EXCLUSIVE

PATENT PENDING

MÁXIMA VERSATILIDAD PARA TUS BUFFETS /
MAXIMUM VERSATILITY FOR YOUR BUFFETS /
VERSATILITÉ OPTIMUM POUR VOS BUFFETS /
MAXIMALE VIELFÄLTIGKEIT IHRER BUFFETS

EXCLUSIVE

PATENT PENDING



**CON CUBIC, AHORA ES EL PRODUCTO
QUE SE ADAPTA A SUS NECESIDADES /**

WITH CUBIC, YOU NOW HAVE THE PRODUCT
THAT ADAPTS TO YOUR NEEDS /

AVEC CUBIC, C'EST DORÉNAVANT LE
PRODUIT QUI S'ADAPTE À VOS BESOINS /

MIT CUBIC, HABEN SIE JETZT DAS PRODUKT, WELCHES
SICH IHREN BEDÜRFNISSEN ANPASST





**MAYOR COMODIDAD Y FUNCIONALIDAD /
GREATER CONVENIENCE AND FUNCTIONALITY /
PLUS PRATIQUE ET PLUS FONCTIONNEL /
HÖHERER KOMFORT UND FUNKTIONALITÄT**

BANDEJAS APILABLES ENTRE SÍ /
STACKABLE TRAYS /
PLATEAUX EMPILABLES ENTRE EUX /
STAPELBARE TABLETS



**MODULARIDAD A LA MÁXIMA EXPRESIÓN /
MODULARITY THAT REFLECTS MAXIMUM EXPRESSION /
MODULARITÉ À SON EXPRESSION MAXIMALE /
MODULVIELFALT FÜR DEN MAXIMALEN AUSDRUCK**

- PERMITE OPTIMIZAR ESPACIO DE EXPOSICIÓN
- REDUCE EL TIEMPO DE MONTAJE Y DESMONTAJE
- FACILIDAD DE TRANSPORTE Y ALMACENAJE

- ALLOWS YOU TO MAXIMISE DISPLAY SPACE
- REDUCES ASSEMBLY AND DISASSEMBLY TIME
- EASY TRANSPORTATION AND STORAGE

- PERMET D'OPTIMISER L'ESPACE D'EXPOSITION
- RÉDUIT LE TEMPS DE MONTAGE ET DE DÉMONTAGE
- FACILITÉ DE TRANSPORT ET ENTREPOSAGE

- OPTIMIERT DEN PLATZ DER PRÄSENTATION
- REDUZIERUNG DER AUFBAU- UND ABBAUZEIT
- EINFACHER TRANSPORT UND LAGERUNG



**PERSONALIZACIÓN DEL BUFFET /
PERSONALISE YOUR BUFFET /
PERSONNALISATION DU BUFFET /
PERSONALISIERUNG DES BUFFETS**

CON LOS SOPORTES DE METACRILATO SE PUEDE IDENTIFICAR EL CONTENIDO DE CADA UNO DE LOS RECIPIENTES, DE UNA FORMA ÁGIL Y ELEGANTE.

METHACRYLATE SUPPORTS ALLOW YOU TO IDENTIFY THE CONTENTS OF EACH CONTAINER, IN AN AGILE AND ELEGANT WAY.

GRÂCE AUX SUPPORTS EN MÉTHACRYLATE ON PEUT IDENTIFIER LE CONTENU DE CHACUN DES RÉCIPIENTS DE FAÇON RAPIDE ET ÉLEGANTE.

MIT DEN STÄNDERN AUS METAARKRYLAT KÖNNEN SIE DEN INHALT JEDES EINZELNEN BEHÄLTERS IDENTIFIZIEREN, IN EINER GESCHICKTEN UND ELEGANTEN ART UND WEISE.



EXCLUSIVE



904.352 Mini bandeja presentación 2 pinchos / Mini 2 skewer serving tray /
Mini plateau présentation 2 piques / Mini Servierplatte für zwei Spiesschen



REF	mm	H mm	Ø AGUJEROS / HOLES / TROUS / LÖCHER mm	PINCHOS	€	U
904.352	152 x 62	40	4	2	63,00	1



904.351 Bandeja cuadrada presentación pinchos / Square skewer serving tray /
Plateau carré présentation piques / Viereckige Servierplatte für Spiesschen



REF	mm	H mm	Ø AGUJEROS / HOLES / TROUS / LÖCHER mm	PINCHOS	€	U
904.351	220 x 215	40	4	16	73,00	1



904.350 Bandeja GN presentación pinchos / GN skewer serving tray /
Plateau GN présentation piques / GN Servierplatte für Spiesschen



REF	mm	H mm	Ø AGUJEROS / HOLES / TROUS / LÖCHER mm	PINCHOS	€	U
904.350	539 x 335	77	4	84	231,50	1



Incluye: bandeja madera + bandeja melamina roble + soporte interior pinchos.
Includes: wooden tray + oak melamine tray + interior skewer stand.
Inclut : plateau bois + plateau mélamine chêne + support intérieur piques.
Enthält: Holztablett + Platte aus Eiche/Melamin + Lochplatte für Spiesschen.

904.370 Soporte polietileno presentación pincho / Polyethylene skewer serving stand /
Support polyéthylène présentation pique / Polyethylenhalterung zum Angebot von Spiesschen



REF	mm	H mm	Ø AGUJEROS / HOLES / TROUS / LÖCHER mm	PINCHOS	€	U
904.370	250 x 250	30	4	25	54,90	1
904.371	250 x 250	30	4	25	54,90	1

Polietileno / Polyethylene / Polyéthylène / Polyethylen
904.370 Blanco / White / Blanc / Weiss
904.371 Negro / Black / Noir / Schwarz

904.360 Soporte presentación pincho estante / Skewer serving rack stand /
Support présentation piques plaque / Schmale Regalhalterung zum Angebot von Spiesschen



INOX - ST/STEEL
EDELSTAHL



REF. 904.360

REF. 904.361

REF	mm	H mm	Ø AGUJEROS / HOLES / TROUS / LÖCHER mm	PINCHOS	€	U
904.360*	448 x 182	42	4	40	28,90	1
904.361**	748 x 182	42	4	68	35,00	1



* Para estante / For shelf / Pour tablette / Für holsregal 904.650 y 904651.
** Para estante / For shelf / Pour tablette / Für holsregal 904.680 y 904681.

Ver en página / Refer to page / Consulter page / Siehe Seite: 254

CUBIC

905.504

Conjunto soporte 4 bols cuadrados / Presentation kit for 4 square bowls /
 Kit support 4 bols carrés / Ständerset mit 4 quadratischen Schalen

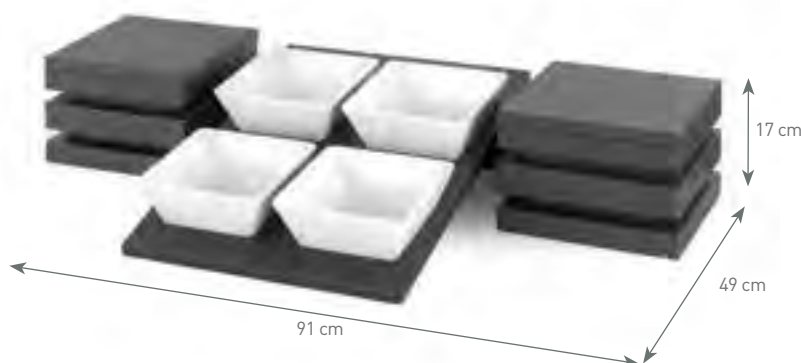

REF	€	U
905.504	346,75	1

Incluye: 2 cubos con tapa + 1 travesaño de 50 cm + 1 presentador de 4 bols + 4 bols de melamina.

Includes: 2 cubes with lid + 1 crossbar 50 cm length + 1 displayer for 4 bowls + 4 melamine bowls.

Inclus: 2 cubes avec couvercle + 1 longeron 50 cm + 1 présentoir pour 4 bols + 4 bols mélamine.

Inklusive: 2 Behälter mit Deckel + 1 Traverse von 50 cm + 1 Halter für 4 Schalen + 4 Schalen aus Melamin.

905.506

Conjunto soporte 6 bols cuadrados / Presentation kit for 6 square bowls /
 Kit support 6 bols carrés / Ständerset mit 6 quadratischen Schalen

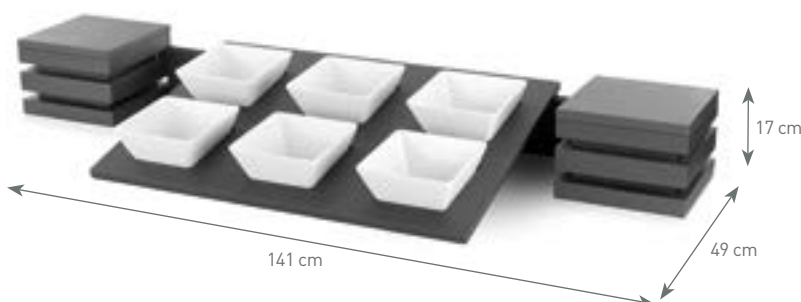

REF	€	U
905.506	378,30	1

Incluye: 2 cubos con tapa + 1 travesaño de 100 cm + 1 presentador de 6 bols + 6 bols de melamina.

Includes: 2 cubes with lid + 1 crossbar 100 cm length + 1 displayer for 6 bowls + 6 melamine bowls.

Inclus: 2 cubes avec couvercle + 1 longeron 100 cm + 1 présentoir pour 6 bols + 6 bols mélamine.

Inklusive: 2 Behälter mit Deckel + 1 Traverse von 100 cm + 1 Halter für 6 Schalen + 6 Schalen aus Melamin

905.516

Conjunto 2 niveles soporte 6 bols / 2 levels presentation kit for 6 square bowls /
 Kit support 6 bols carrés deux niveaux / 2 Ebenen Ständerset mit 6 quadratischen Schalen

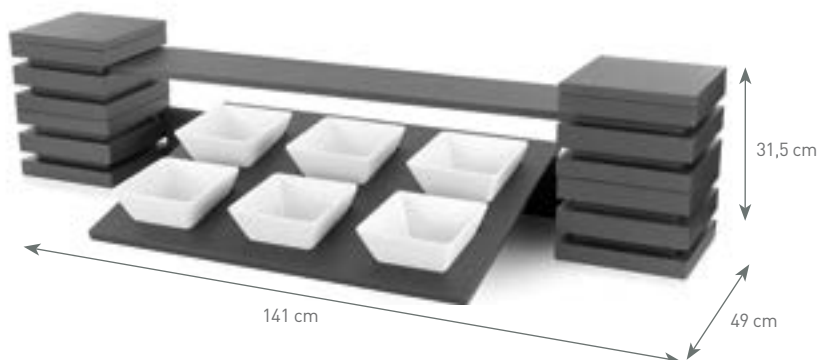

REF	€	U
905.516	619,45	1

Incluye: 4 cubos con tapa + 1 travesaño de 100 cm + 1 presentador de 6 bols + 6 bols de melamina + 1 estante estrecho de 100 cm.

Includes: 4 cubes with lid + 1 crossbar 100 cm length + 1 displayer for 6 bowls + 6 melamine bowls + 1 narrow shelf 100 cm.

Inclus: 4 cubes avec couvercle + 1 longeron 100 cm + 1 présentoir pour 6 bols + 6 bols mélamine + 1 tablette étroite 100 cm.

Inklusive: 4 Behälter mit Deckel + 1 Traverse von 100 cm + 1 Halter für 6 Schalen + 6 Schalen aus Melamin + 1 schmales Regal von 100 cm.

905.508 Conjunto soporte 8 bols cuadrados / Presentation kit for 8 square bowls /
 Kit support 8 bols carrés / Ständerset mit 8 quadratischen Schalen

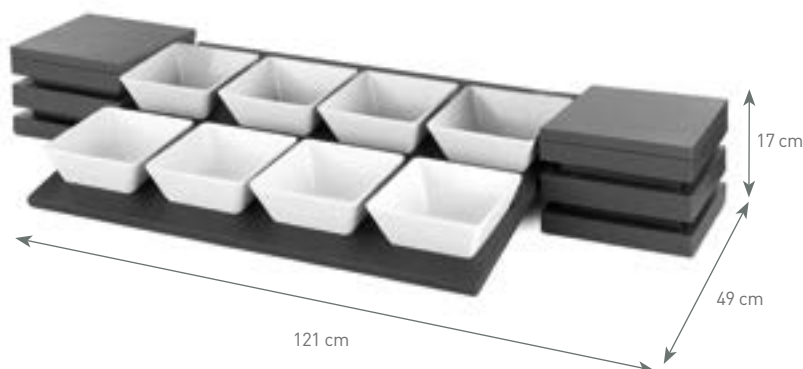

REF	€	U
905.508	393,30	1

Incluye: 2 cubos con tapa + 1 travesaño de 80 cm + 2 presentadores de 4 bols + 8 bols de melamina.

Includes: 2 cubes with lid + 1 crossbar 80 cm length + 2 displayers for 4 bowls + 8 melamine bowls.

Inclus: 2 cubes avec couvercle + 1 longeron 80 cm + 2 présentoirs pour 4 bols + 8 bols mélamine.

Inklusive: 2 Behälter mit Deckel + 1 Traverse von 80 cm + 1 Halter für 4 Schalen + 8 Schalen aus Melamin.

905.518 Conjunto 2 niveles soporte 8 bols / 2 levels presentation kit for 8 square bowls /
 Kit support 8 bols carrés deux niveaux / 2 Ebenen Ständerset mit 8 quadratischen Schalen

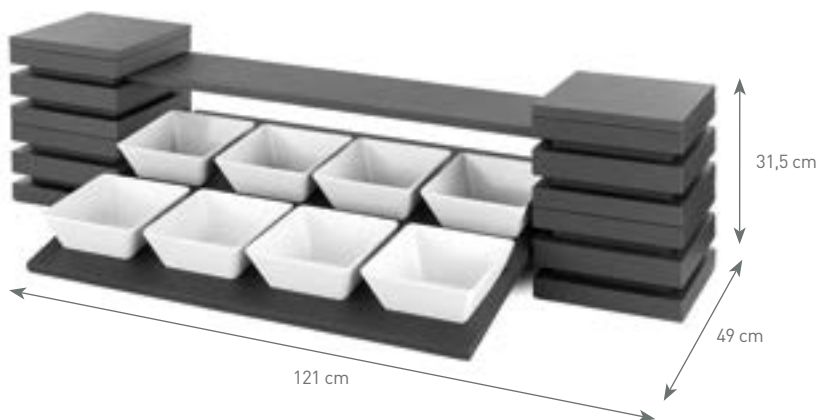

REF	€	U
905.518	620,50	1

Incluye: 4 cubos con tapa + 1 travesaño de 80 cm + 2 presentadores de 4 bols + 8 bols de melamina + 1 estante estrecho de 80 cm.

Includes: 4 cubes with lid + 1 crossbar 80 cm length + 2 displayers for 4 bowls + 8 melamine bowls + 1 narrow shelf 80 cm.

Inclus: 4 cubes avec couvercle + 1 longeron 80 cm + 2 présentoirs pour 4 bols + 8 bols mélamine + 1 tablette étroite 80 cm.

Inklusive: 4 Behälter mit Deckel + 1 Traverse von 80 cm + 1 Halter für 4 Schalen + 8 Schalen aus Melamin + 1 schmales Regal von 80 cm.

905.400 Conjunto básico estante 2 niveles / Basic two levels presentation kit /
 Kit basique présentation 2 niveaux / Basisregalset 2 Ebenen



REF	€	U
905.400	496,80	1

Incluye: 4 cubos con tapa + 1 estante ancho de 100 cm + 1 estante estrecho de 100 cm.

Includes: 4 cubes with lid + 1 wide shelf 100 cm + 1 narrow shelf 100 cm.

Inclus: 4 cubes avec couvercle + 1 tablette large 100 cm + 1 tablette étroite 100 cm.

Inklusive: 4 Behälter mit Deckel + 1 breites Regal von 100 cm + 1 schmales Regal von 100 cm.

CUBIC

905.410

Conjunto estante dos niveles forma "L" / "L" shape two levels presentation kit /
 Kit présentation "L" 2 niveaux / Regalset 2 Ebenen "L" Form

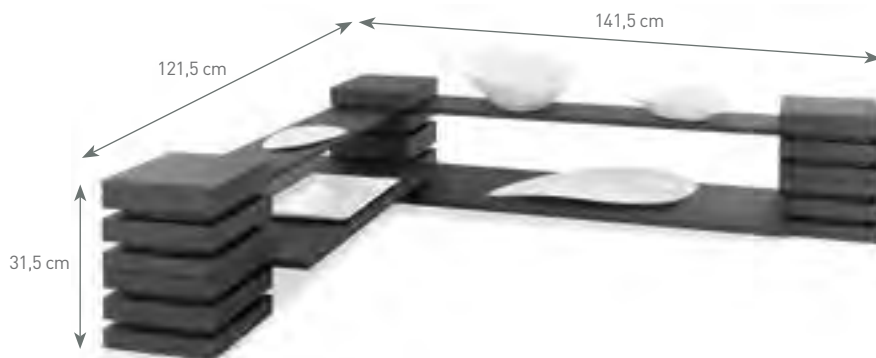

REF	€	U
905.410	786,60	1

Incluye: 6 cubos con tapa + 1 estante ancho de 100 cm + 1 estante estrecho de 100 cm + 1 estante ancho de 80 cm + 1 estante estrecho de 80 cm.

Includes: 6 cubes with lid + 1 wide shelf 100 cm + 1 narrow shelf 100 cm + 1 wide shelf 80 cm + 1 narrow shelf 80 cm.

Inclus: 6 cubes avec couvercle + 1 tablette large 100 cm + 1 tablette étroite 100 cm + 1 tablette large 80 cm + 1 tablette étroite 80 cm.

Inklusive: 6 Behälter mit Deckel + 1 breites Regal von 100 cm + 1 schmales Regal von 100 cm + 1 breites Regal von 80 cm + 1 schmales Regal von 80 cm.

905.300

Conjunto 2 bandejas presentación 40x40 cm / Two trays 40x40 cm presentation kit /
 Kit présentation pour deux plateaux 40x40 cm / Set mit 2 Präsentationstabletts 40x40 cm

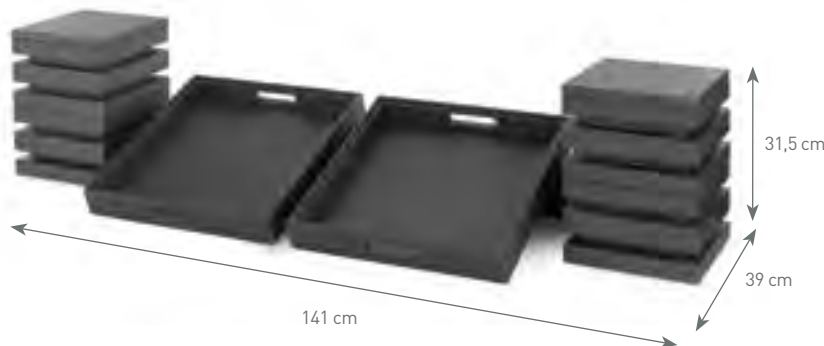

REF	€	U
905.300	595,15	1

Incluye: 4 cubos con tapa + 1 travesaño de 100 cm + 2 bandejas presentación de 40 x 40 cm.

Includes: 4 cubes with lid + 1 crossbar 100 cm length + 2 serving trays 40 x 40 cm.

Inclus: 4 cubes avec couvercle + 1 longeron 100 cm + 2 plateaux présentation 40 x 40 cm.

Inklusive: 4 Behälter mit Deckel + 1 Traverse von 100 cm + 2 tablettts 40 x 40 cm.

905.310

Conjunto 2 niveles bandejas 40x40 cm / 2 levels presentation kit for 40x40 cm trays /
 Kit présentation 2 niveaux pour plateaux 40x40 cm / Set 2 Ebenen mit 2 Präsentationstabletts 40x40 cm



REF	€	U
905.310	826,45	1

Incluye: 6 cubos con tapa + 1 travesaño de 100 cm + 2 bandejas presentación de 40 x 40 cm + 1 estante estrecho de 100 cm.

Includes: 6 cubes with lid + 1 crossbar 100 cm length + 2 serving trays 40 x 40 cm + 1 narrow shelf 100 cm.

Inclus: 6 cubes avec couvercle + 1 longeron 100 cm + 2 plateaux présentation 40 x 40 cm + 1 tablette étroite 100 cm.

Inklusive: 4 Behälter mit Deckel + 1 Traverse von 100 cm + 2 Präsentationstabletts 40 x 40 cm + 1 schmales Regal 100 cm.

905.320

Conjunto 2 bandejas 60x40 / Two trays 60x40 cm presentation kit /
Kit présentation pour deux plateaux 60x40 cm / Set mit 2 Präsentationstabletts 60x40 cm



REF	€	U
905.320	429,55	1

Incluye: 2 cubos con tapa + 1 travesaño de 100 cm + 2 bandejas presentación de 60 x 40 cm.

Includes: 2 cubes with lid + 1 crossbar 100 cm length + 2 serving trays 60 x 40 cm.

Inclus: 2 cubes avec couvercle + 1 longeron 100 cm + 2 plateaux présentation 60 x 40 cm.

Inklusive: 2 Behälter mit Deckel + 1 Traverse von 100 cm + 2 Präsentationstabletts 60 x 40 cm.

905.340

Conjunto 2 niveles para bandejas 60x40 cm / 2 levels for trays 60x40 presentation kit /
Kit présentation 2 niveaux pour plateaux 60x40 cm / Set 2 Ebenen mit 2 Präsentationstabletts 60x40

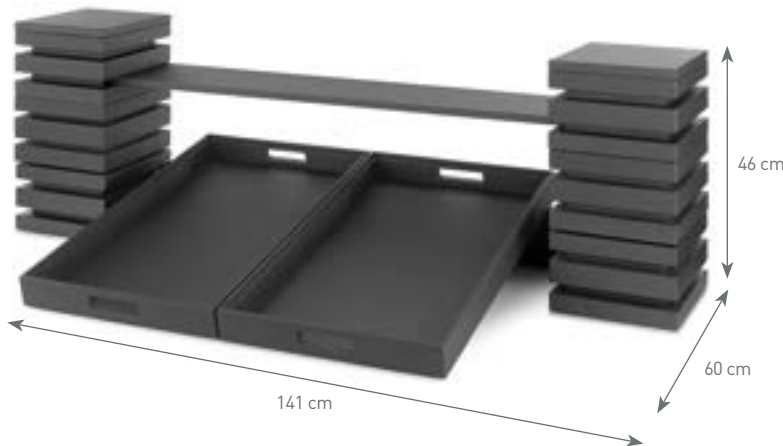

REF	€	U
905.340	853,90	1

Incluye: 6 cubos con tapa + 1 travesaño de 100 cm + 2 bandejas presentación de 60 x 40 cm + 1 estante estrecho de 100 cm.

Includes: 6 cubes with lid + 1 crossbar 100 cm length + 2 serving trays 60 x 40 cm + 1 narrow shelf 100 cm.

Inclus: 6 cubes avec couvercle + 1 longeron 100 cm + 2 plateaux présentation 60 x 40 cm + 1 tablette étroite 100 cm.

Inklusive: 6 Behälter mit Deckel + 1 Traverse von 100 cm + 2 Präsentationstabletts 60 x 40 cm + 1 schmales Regal 100 cm.

905.200

Conjunto buffet desayuno / Breakfast buffet displayer kit /
Kit présentation petit déjeuner / Frühstücksbuffetset



REF	€	U
905.200	641,70	1

Incluye: 2 cubos con tapa + 1 travesaño de 80 cm + 1 bandeja presentación de 60 x 40 cm + 1 kit completo dispensador de zumos de 6 lts.

Includes: 2 cubes with lid + 1 crossbar 80 cm length + 1 serving tray 60 x 40 cm + 1 complet kit juice dispenser 6 lts.

Inclus: 2 cubes avec couvercle + 1 longeron 80 cm + 1 plateau présentation 60 x 40 cm + 1 kit complet distributeur à jus 6 lts.

Inklusive: 2 Behälter mit Deckel + 1 Traverse von 80 cm + 2 Präsentationstabletts 60 x 40 cm + 1 komplettes Saftspenderset 6 Liter.

CUBIC

904.800

Dispensador zumos 6 lts. / Juice dispenser 6 lts. /
 Distributeur à jus 6 lts / Saftspender 6 Liter



REF	mm	H mm	Lts	€	U
904.800	230 x 390	490	6,00	305,35	1

904.790

Expositor GN 2/3, tres niveles / Three levels 2/3 GN stand /
 Présentoir 3 niveaux pour GN 2/3 / Ständer GN 2/3 drei Ebenen



REF	mm	H mm	€	U
904.790	650 x 380	590	203,40	1

Incluye: 3 cubetas GN 2/3 20 mm /
 Includes: 3 GN containers 2/3 20 mm /
 Inclus: 3 bags GN 2/3 20 mm /
 Inklusive: 3 GN 2/3 20 mm

**LOS DETALLES NOS IMPORTAN /
WE PAY ATTENTION TO DETAIL /
LES DÉTAILS NOUS IMPORTENT /
DIE DETAILS SIND UNS WICHTIG**



CUBIC

904.780 Bandeja porta-cubiertos / Cutlery-holder tray / Plateau porte-couverts / Beteckbehälter



GN 1/1



REF	mm	H mm	€	U
904.780	539 x 335	77	127,80	1

4

303 x 115 mm

Apilables /
Stackables /
Empilables /
Stapelbar

Compartimentos /
Compartments /
Compartiments /
Fächer

904.740 Bandeja presentación / Serving tray / Plateau présentation / Präsentationstablent



REF	mm	H mm	€	U
904.740	400 x 400	65	88,50	1

Apilables /
Stackables /
Empilables /
Stapelbar

904.760 Bandeja servicio y presentación / Serving tray / Plateau service et présentation / Servier- und Präsentationstablent



REF	mm	H mm	€	U
904.760	600 x 400	65	98,75	1

Apilables /
Stackables /
Empilables /
Stapelbar

IDEA!

Perfecta para servicio habitaciones /
Room service tray /
Plateau idéal pour service de chambre /
Perfekt für den Zimmerservice

904.711 Bandeja servicio y presentación GN 1/1 / 1/1 GN serving tray / Plateau service et présentation GN 1/1 / Servier- und Präsentationstablent GN 1/1



No incluye cubeta gastronorm 1/1 /
1/1 Gastronorm container not included /
Bac gastronorme 1/1 non inclus /
Nicht inklusive Gastronormbehälter 1/1

REF	mm	H mm	€	U
904.711	539 x 335 (1/1)	77	87,60	1

GN 1/1

Apilables /
Stackables /
Empilables /
Stapelbar



904.720 Servilletero y dispensador bolsas te y azúcar / Napkin and tea & sugar bags dispenser / Distributeur serviettes et des saquettes thé & sucre / Serviettenhalter und Tee- und Zuckerbeutelhalter

REF	mm	H mm	€	U
904.720	220 x 220	55	42,25	1
904.725	220 x 220	55	65,75	1



Ref. 904.720



Ref. 904.725

904.810 Mesita buffet baja + taco madera / Low wooden table + cutting board / Table basse en bois + planche à découper / Flaches Buffettischchen + Holzschneidebrett

REF	mm	H mm	€	U
904.810	325 x 220	120	103,00	1
904.820	325 x 220	165	114,70	1
904.890	325 x 220	210	124,75	1



Ref. 904.890

Ref. 904.820

Ref. 904.810

904.850 Mesita buffet GN 1/1 + taco madera / 1/1 GN wooden table + cutting board / Table GN 1/1 en bois + planche à découper / Buffettischchen GN 1/1 + Holzschneidebrett

REF	mm	H mm	€	U
904.850	530 x 325	120	135,30	1



20072 Portamenús metacrilato / Methacrylate holder / Porte-menus méthacrylate / Metaakrylat Kartenhalter

REF	cm	€	U
20072	6 x 6	6,65	1



CUBIC

904.600

Cubo con tapa madera / Wooden cube with lid /
Cube en bois avec couvercle / Behälter mit Holzdeckel

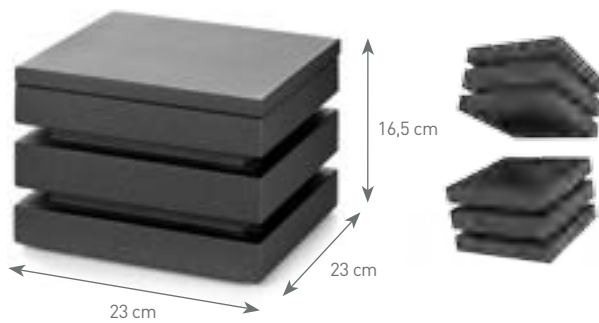

REF	COLOR	€	U
904.600	NEGRO / BLACK / NOIR / SCHWARZ	104,65	1
904.601	BLANCO / WHITE / BLANC / WEISS	104,65	1

904.660

Tapa madera / Wooden lid /
Couvercle en bois / Holzdeckel



REF	COLOR	€	U
904.660	NEGRO / BLACK / NOIR / SCHWARZ	14,90	1
904.661	BLANCO / WHITE / BLANC / WEISS	14,90	1

REF. 904.660 / 904.661

904.650

Estante madera estrecho / Wooden narrow shelf /
Tablette en bois étroite / Schmales Holzregal

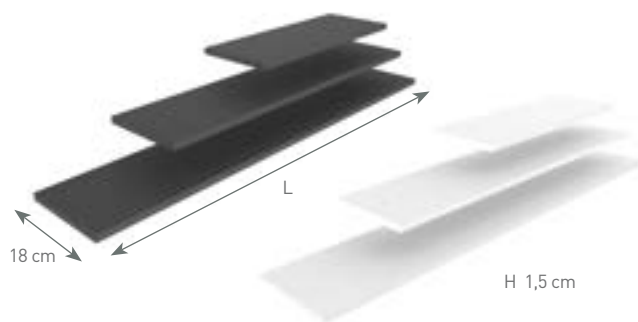

REF	COLOR	L cm	€	U
904.650	NEGRO / BLACK / NOIR / SCHWARZ	50	28,65	1
904.680	NEGRO / BLACK / NOIR / SCHWARZ	80	36,40	1
904.610	NEGRO / BLACK / NOIR / SCHWARZ	100	37,55	1
904.651	BLANCO / WHITE / BLANC / WEISS	50	28,65	1
904.681	BLANCO / WHITE / BLANC / WEISS	80	36,40	1
904.611	BLANCO / WHITE / BLANC / WEISS	100	37,55	1

904.652

Estante madera ancho / Wooden wide shelf /
Tablette en bois large / Breites Holzregalbrett

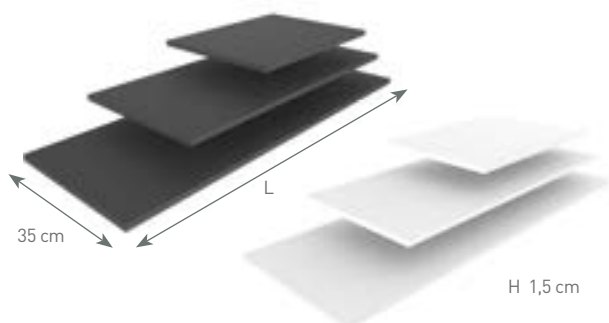

REF	COLOR	L cm	€	U
904.652	NEGRO / BLACK / NOIR / SCHWARZ	50	51,95	1
904.682	NEGRO / BLACK / NOIR / SCHWARZ	80	67,35	1
904.612	NEGRO / BLACK / NOIR / SCHWARZ	100	69,60	1
904.653	BLANCO / WHITE / BLANC / WEISS	50	51,95	1
904.683	BLANCO / WHITE / BLANC / WEISS	80	67,35	1
904.613	BLANCO / WHITE / BLANC / WEISS	100	69,60	1

904.950 Travesaño soporte bandejas / Crossbar buffet trays /
Longerons pour plateaux buffet / Tablethaltertraverse

REF	mm	H mm	€	U
904.950	500 x 124	20	49,20	1
904.980	800 x 124	20	53,85	1
904.990	1000 x 124	20	57,45	1



Ref. 904.950



Ref. 904.980



Ref. 904.990



904.937 Presentador 4 bols melamina cuadrados / Displayer for 4 melanine bowls /
Présntoir 4 bols melamine / Halter für 4 quadratische Melaminschalen

REF	mm	H mm	€	U
904.937	375 x 500	15	74,00	1



Para bols cuadrados 180 x 180 Ref. 22202 /
For square bowls 180 x 180 Ref. 22202 /
Pour bols carrés 180 x 180 Ref. 22202 /
Für quadratische Schalen 180 x 180 Ref. 22202

Ver en página / Refer to page / Consulter page / Siehe Seite: 306

904.975 Presentador 6 bols melamina cuadrados / Displayer for 6 melanine bowls /
Présntoir 6 bols melamine / Halter für 6 quadratische Melaminschalen

REF	mm	H mm	€	U
904.975	750 x 500	15	87,25	1



Para bols cuadrados 180 x 180 Ref. 22202 /
For square bowls 180 x 180 Ref. 22202 /
Pour bols carrés 180 x 180 Ref. 22202 /
Für quadratische Schalen 180 x 180 Ref. 22202

Ver en página / Refer to page / Consulter page / Siehe Seite: 306

CUBIC

904.155 Enfriador botellas buffet / Buffet wine cooler /
Refrâchisseur bouteilles / Buffetflaschenkühler

REF	cm	H cm	€	U
904.155	57 x 37	14,5	186,95	1

Incluye: marco madera + cubeta GN 1/1 150 mm /
Includes: wooden frame + 1/1 GN pan 150 mm /
Inclus: cadre en bois + bac GN 1/1 150 mm /
Inklusive: Holzrahmen + GN 1/1 Behälter 150 mm

904.157 Enfriador botellas caja madera / Wine cooler wooden box /
Boîte en bois refroidissement bouteilles / Flaschenkühler Holzkiste

REF	cm	H cm	€	U
904.157	32,5 x 26,5	15,0	62,65	1

Incluye: caja madera + cubeta GN 1/2 150 mm /
Includes: wooden box + 1/2 GN pan 150 mm /
Inclus: boîte en bois + bac GN 1/2 150 mm /
Inklusive: Holzkiste + GN 1/2 Behälter 150 mm

904.150 Buffet cubiteras / Buffet buckets display /
Buffet seaux à champagne / Buffetsektkühler

REF	COLOR	cm	H cm	€	U
904.150	NEGRO / BLACK / NOIR / SCHWARZ	57 x 37	25,5	245,55	1
904.150W	BLANCO / WHITE / BLANC / WEISS	57 x 37	25,5	245,55	1

Incluye: marco madera + soporte cubetas + cubeta GN 1/ 120 mm + 2 u. cubiteras /
Includes: wooden frame + bucket holder + gastronorm pan 1/120 mm + 2 u. wine buckets /
Inclus: cadre en bois + support seaux + bac GN 1/1 20 mm + 2 u. seaux à champagne /
Inklusive: Holzkiste + Kühlerhalter + GN 1/1 Behälter 120 mm + 2 Sektkühler

904.165 Buffet perforado / Perforated buffet display / Buffet perforé / Gelochte Buffetvitrine



REF	COLOR	cm	H cm	€	U
904.165	NEGRO / BLACK / NOIR / SCHWARZ	57 x 37	31,0	224,50	1
904.165W	BLANCO / WHITE / BLANC / WEISS	57 x 37	31,0	224,50	1

Incluye: marco madera + bandeja perforada gn 1/1 65 mm + cubeta GN 1/1 20 mm + cúpula roll-top /
 Includes: wooden frame + perforated 1/1 gn pan 65 mm + gastronorm pan 1/1 20 mm + roll-top lid /
 Inclus: cadre en bois + bac gn 1/1 65 mm perforé + bac GN 1/1 20 Mm + couvercle roll-top /
 Inklusive: Holzrahmen + gelochtes Tablett GN 1/1 Behälter 65 mm + GN 1/1 Behälter 20 mm + Rolldeckel

904.120 Buffet estandar / Standard buffet display / Buffet standard / Standardbuffet



REF	COLOR	cm	H cm	€	U
904.120	NEGRO / BLACK / NOIR / SCHWARZ	57 x 37	31,0	211,70	1
904.120W	BLANCO / WHITE / BLANC / WEISS	57 x 37	31,0	211,70	1

Incluye: marco madera + 2 u. + cubeta GN 1/1 20 mm + cúpula roll-top /
 Includes: wooden frame + 2u. 1/1 GN 1/1 20 mm + roll-top lid /
 Inclus: cadre en bois + 2 u. bacs GN 1/1 20 mm + couvercle roll-top /
 Inklusive: Holzrahmen + 2 GN 1/1 Behälter 20 mm + Rolldeckel

904.113 Buffet triple / Triple buffet display / Buffet triple / Dreifach Buffetvitrine



REF	COLOR	cm	H cm	€	U
904.113	NEGRO / BLACK / NOIR / SCHWARZ	57 x 37	31,0	223,75	1
904.113W	BLANCO / WHITE / BLANC / WEISS	57 x 37	31,0	223,75	1

Incluye: marco madera + 3 cubetas gn 1/3 + cubeta GN 1/1 20 mm + cúpula roll-top /
 Includes: wooden frame + 3 units 1/3 GN pans 65 mm + gastronorm pan 1/1 20 mm + roll-top lid /
 Inclus: cadre en bois + 3 bacs gn 1/3 65 mm + bac GN 1 20 mm + couvercle roll-top /
 Inklusive: Holzrahmen + 3 GN 1/3 Behälter + 1 GN 1/1 Behälter 20 mm + Rolldeckel

SERVICIO DE MESA Y BUFFET /
 TABLE AND BUFFET SERVICE /
 SERVICE DE TABLE ET BUFFET

CUBIC

904.140Buffet quesos / Cheese buffet display /
Buffet fromage / Buffetvitrine für Käse

REF	COLOR	cm	H cm	€	U
904.140	NEGRO / BLACK / NOIR / SCHWARZ	57 x 37	31,0	249,65	1
904.140W	BLANCO / WHITE / BLANC / WEISS	57 x 37	31,0	249,65	1

Incluye: marco madera + bandeja corte madera + cubeta GN 1/1 20 mm + cupula roll-top /
Includes: wooden frame + wooden cutting board + gastronorm pan 1/1 20 mm + roll-top lid /
Inclus: cadre en bois + planque à découper en bois + bac GN 1/1 20 mm couvercle roll-top /
Inklusive: Holzrahmen + Holzschneidebrett + 1 GN 1/1 Behälter 20 mm + Rolldeckel

904.145Buffet pan / Bread buffet display /
Buffet pain / Buffet Brotplatte

REF	COLOR	cm	H cm	€	U
904.145	NEGRO / BLACK / NOIR / SCHWARZ	57 x 37	14,5	166,85	1
904.145W	BLANCO / WHITE / BLANC / WEISS	57 x 37	14,5	166,85	1

Incluye: marco madera + cortador par madera + cubeta GN 1/1 20 mm /
Includes: wooden frame + bread cutting board + 1/1 GN container 1/1 20 mm /
Inclus: cadre en bois + plaque à découper pain en bois + bac GN 1/1 20 mm bac gn 1/1 20 mm /
Inklusive: Holzrahmen + Holzbrotschneidebrett + 1 GN 1/1 Behälter 20 mm

904.160Buffet pizarra melamina / Melaminese slate buffet displayer /
Mélamine buffet ardoise / Buffet Melaminschiefertafel

REF	COLOR	cm	H cm	€	U
904.160	NEGRO / BLACK / NOIR / SCHWARZ	57 x 37	14,5	180,45	1
904.160W	BLANCO / WHITE / BLANC / WEISS	57 x 37	14,5	180,45	1

Incluye: marco madera + tabla pizarra melamina + cubeta GN 1/1 20 mm /
Includes: wooden frame + melamine slate board + 1/1 GN container 1/1 20 mm /
Inclus: cadre en bois + plaque ardoise en melamine + bac GN 1/1 20 mm bac GN 1/1 20 mm /
Inklusive: Holzrahmen + Melaminschiefertafel + 1 GN 1/1 Behälter 20 mm

904.200 Marco madera / Wooden frame /
Cadre en bois / Holzrahmen



REF. 904.200

REF	COLOR / COULEUR	cm	H cm	€	U
904.200	NEGRO / BLACK / NOIR / SCHWARZ	57 x 37	14,5	111,30	1
904.100	BLANCO / WHITE / BLANC / WEISS	57 x 37	14,5	111,30	1

904.300 Tapa roll-top / Roll-top lid /
Couvercle roll-top / Rolldeckel



REF. 904.300

REF	cm	H cm	€	U
904.300	57 x 32,5	17,5	62,30	1

904.500 Placa enfriadora / Cooling plate /
Plaque réfrigérante / Kühlakku



REF	cm	H cm	€	U
904.500	47,5 x 27,7	3,0	59,50	1

- 12 °C

ADAPTABLE A CUBETA GN 1/1.
ADJUSTABLE TO 1/1 GN PAN.
ADAPTABLE À BAC GN 1/1
GEEIGNET FÜR GN 1/1 BEHÄLTER.

904.400 Tapete isotérmico / Isothermal mat /
Tapis isotherme / Isothermische Matte



REF. 904.400

REF	cm	H cm	€	U
904.400	47 x 26	2,0	9,40	1

FRÍO / COLD / FROID / KALT

CALIENTE / HOT / CHAUD / WARM



110.201 Cubeta gastronorm / Gastronorm container /
Bac gastronorme / Gastronormbehälter



REF	cm	H cm	€	U
110.201	53 x 32,5	2,0	18,05	1

CUBIC

904.151 Soporte cubiteras / Buckets holder /
Support seaux / Kühlerhalter

REF	cm	Ø cm	H cm	€	U
904.151	53 x 32,5	22	5,0	41,90	1

3110510 / 236.020 Cubitera y tapa / Bucket and lid /
Seau et couvercle / Kühler und Deckel

REF. 3110510

REF. 236.020

REF	Ø cm	H cm	€	U
3110510	20	20,0	29,60	1
236.020	20	-	15,35	1

904.142 Conjunto tabla madera + cubeta inox / Set wooden board + St/Steel container /
Set tablette en bois + bac inox / Set Holzschneidebrett + Edelstahlbehälter

GN 1/1

REF	cm	H cm	€	U
904.142	53 x 32,5	2,0	73,95	1

22161 Presentador pizarra-granito melamina / Melamine slate-granite display /
Présentoir ardoise-granite mélamine / Melamin Schiefer-Granittafel

GN 1/1

REF	cm	H cm	€	U
22161	53 x 32,5	0,7	40,40	1

904.146 Cortador pan madera / Wooden bread cutting board /
Plaque à découper pain en bois / Brotschneidebrett aus Holz

REF	cm	H cm	€	U
904.146	52 x 31,5	2,0	31,95	1

904.804 Taco madera para mesita buffet / Cutting board for wooden table /
 Planche à découper pour table en bois / Holzschneidebrett für Buffettisch



REF	mm	H mm	€	U
904.804 ¹	292 x 187	22	30,55	1
904.809 ²	497 x 292	22	41,30	1

(1) Para / for / pour / für: ref. 904.810 / 904.820 / 904.890
 (2) Para / for / pour / für: ref. 904.850

904.721 Soporte bolsas te/azúcar / Tea & sugar bag holder /
 Support pour saquettes de thé & sucre / Tee- & Zuckerbeutelhalter



REF	mm	H mm	€	U
904.721	198 x 198	49	25,40	1

Para / for / pour / für: Ref. 904.720

904.801 Cubo base dispensador zumos / Juice dispenser cube holder /
 Cube base distributeur à jus / Basisständer für Saftspender



REF	mm	H mm	€	U
904.801	230 x 230	215	119,05	1

904.807 Contenedor acrílico 6 lts dispensador zumos con tapa / 6 lts acrylic container with lid for juice dispenser /
 Conteneur acrylic 6 lts avec couvercle pour distributeur à jus / 6 Liter Acrylbehälter mit Deckel für Saftspender



REF	Ø cm	H cm	Lts	€	U
904.807	22	28,0	6,00	144,90	1

904.806 Soporte y rejilla dispensador de zumos / Base and grid for water drain /
 Base et grille pour distributeur à jus / Basis und Gitter für Saftspender



REF	mm	H mm	€	U
904.806	230 x 190	19,5	68,85	1

SERVICIO DE MESA Y BUFFET /
 TABLE AND BUFFET SERVICE /
 SERVICE DE TABLE ET BUFFET



VER EN / SEE ON /
VOIR PAGE / SIEHE SEITEN 149

590.001 Vitrina rectangular / Rectangular display cabinet /
Vitrine rectangulaire / Auslagevitrine, rechteckige



REF	cm	H cm	BASE ÚTIL / FUNCTIONAL BASIC / BASE UTILE / NÜTZLICHE GRUNDAUSRÜSTUNG cm	€	U
590.001	40 x 24,5	15,5	34 x 19	41,00	1
590.002	50,5 x 30,5	18,0	44 x 24,5	46,75	1

Plástico /
Plastic /
Plastique /
Plastik

590.003 Vitrina doble / Double display cabinet /
Vitrine double / Doppel -Auslagevitrine



REF	cm	H cm	BASE ÚTIL / FUNCTIONAL BASIC / BASE UTILE / NÜTZLICHE GRUNDAUSRÜSTUNG cm	€	U
590.003	40 x 24,5	32	2 x (34 x 19)	73,80	1
590.004	50,5 x 30,5	40	2 x (44 x 24,5)	93,50	1

Plástico /
Plastic /
Plastique /
Plastik

590.005 Vitrina redonda / Round display cabinet /
Vitrine ronde / Auslagevitrine, rund



REF	Ø cm	H cm	BASE ÚTIL / FUNCTIONAL BASIC / BASE UTILE / NÜTZLICHE GRUNDAUSRÜSTUNG cm	€	U
590.005	32	18	Ø 23,5	31,70	1
590.006	46	26	Ø 37,5	44,80	1

Plástico /
Plastic /
Plastique /
Plastik

BUFFET CLASSIC

361 Cacillo monobloc / One piece ladle / Louche monobloc / Schöpflöffel Monoblock



Mango anatómico
Anatomical handle
Manche anatomique
Anatomischer Griff

Monobloc
One piece
Monobloc
Monoblock

REF	Ø cm	L cm	Lts	€	U
361.000	9	30	0,10	12,20	1

362 Espumadera monobloc / One piece skimmer / Écumoire monobloc / Schaumlöffel Monoblock



REF	Ø cm	L cm	€	U
362.000	11	33,5	11,55	1

363 Espátula monobloc / One piece turner / Spatule monobloc / Pfannenwender Monoblock



REF	L cm	€	U
363.000	32	10,20	1

364 Cuchara de servicio monobloc / One piece serving spoon / Cuillère de service monobloc / Servierlöffel Monoblock



REF	L cm	€	U
364.000	31	9,15	1

365 Tenedor monobloc / One piece fork / Fourchette monobloc / Fleischgabel Monoblock



REF	L cm	€	U
365.000	32	8,20	1

360 Juego de cocina 5 piezas con soporte de pared / 5 pieces kitchen tool set with hook rack / Jeu de 5 ustensiles de cuisine avec support mural / 5- teiliges Küchenset mit Wandhalterung



REF	€	U
360.000	56,85	1

366 Cacillo salsas monobloc / One piece sauce ladle /
Cuillère à sauces monobloc / Sossenlöffel Monoblock



REF	Ø cm	L cm	€	U
366.000	7	28	10,95	1

367 Cuchara ensalada monobloc / One piece salad spoon /
Cuillère à salade monobloc / Salatlöffel Monoblock



REF	L cm	€	U
367.000	30	9,25	1

368 Cuchillo cocina / Carving knife /
Couteau de cuisine / Küchenmesser



REF	L cm	€	U
368.000	28,5	6,65	1

369 Pala pasteles / Cake server /
Pelle à gâteau / Keksschaufel



REF	L cm	€	U
369.000	22	7,45	1

370 Cuchillo pastelería / Cake knife /
Couteau à pâtisserie / Pâtisseriesmesser



REF	L cm	€	U
370.000	29,5	8,60	1

371 Soporte de pared con 5 ganchos / 5-hook rack /
Support mural avec 5 crochets / Wandhalter mit 5 Haken

**NUEVO MODELO /
NEW MODEL /
NOUVEAU MODÈLE /
NEUES MODELL**



REF	L cm	€	U
371.000	33	6,00	1

Pulido brillante
Mirror polishing
Polissage brillant
Glänzend poliert

BUFFET ERGO

3611 Cacillo monobloc / One piece ladle /
Louche monobloc / Schöpflöffel Monoblock

Mango anatómico
Anatomical handle
Manche anatomique
Anatomischer Griff

Monobloc
One piece
Monobloc
Monoblock

REF	Ø cm	L cm	Lts	€	U
361.100	9,5	32	0,15	8,70	1

Pulido brillante
Mirror polishing
Polissage brillant
Glänzend poliert

3621 Espumadera monobloc / One piece skimmer /
Écumoire monobloc / Schaumlöffel Monoblock

REF	Ø cm	L cm	€	U
362.100	11	35	7,90	1

Pulido brillante
Mirror polishing
Polissage brillant
Glänzend poliert

3631 Espátula monobloc / One piece turner /
Spatule monobloc / Pfannenwender Monoblock

REF	L cm	€	U
363.100	37	7,45	1

Pulido brillante
Mirror polishing
Polissage brillant
Glänzend poliert

3641 Cuchara de servicio monobloc / One piece serving spoon /
Cuillère de service monobloc / Servierlöffel Monoblock

REF	L cm	€	U
364.100	34,5	6,75	1

Pulido brillante
Mirror polishing
Polissage brillant
Glänzend poliert

3651 Tenedor monobloc / One piece fork /
Fourchette monobloc / Fleischgabel

REF	L cm	€	U
365.100	37	5,65	1

Pulido brillante
Mirror polishing
Polissage brillant
Glänzend poliert

3661 Cacillo salsas monobloc / One piece sauce ladle /
Cuillère à sauces monobloc / Sossenlöffel



REF	cm	L cm	Lts	€	U
366.100	6,5 x 8	36	0,04	7,35	1

Pulido brillante
Mirror polishing
Polissage brillant
Glänzend poliert

3671 Cuchara para spaghetti / Spaghetti server /
Cuillère à spaghetti / Spaghettilöffel



REF	L cm	€	U
367.100	35	6,75	1

Pulido brillante
Mirror polishing
Polissage brillant
Glänzend poliert

368 Cuchillo cocina / Carving knife /
Couteau de cuisine / Küchenmesser



REF	L cm	€	U
368.000	28,5	6,65	1

Pulido brillante
Mirror polishing
Polissage brillant
Glänzend poliert

3691 Pala pasteles / Cake server /
Pelle à gâteau / Keksschaufel



REF	L cm	€	U
369.100	31	4,30	1

Pulido brillante
Mirror polishing
Polissage brillant
Glänzend poliert

370 Cuchillo pastelería / Cake knife /
Couteau à pâtisserie / Patisseriemesser



REF	L cm	€	U
370.000	29,5	8,60	1

Pulido brillante
Mirror polishing
Polissage brillant
Glänzend poliert

346 Soporte de pared 5 piezas acero inox / 5-hook rack St/Steel /
Support mural 5 crochets acier inox / Edelstahl Wandhalterung mit 5 Haken

NUEVO MODELO /
NEW MODEL /
NOUVEAU MODÈLE /
NEUES MODELL



REF	L cm	€	U
346.000	33	8,80	1

Pulido brillante
Mirror polishing
Polissage brillant
Glänzend poliert

BUFFET COMET

341

Cacillo monobloc. Acero inox 18% cr. / One piece ladle. 18% cr. St/Steel /
Louche monobloc. inox 18% cr. / Schöpflöffel Monoblock. Edelstahl 18 % Cr



REF	Ø cm	L cm	Lts	€	U
341.000	8,5	28	0,10	6,75	1
Pulido satinado mate Mat satiny polishing Poli satiné mat Matt satiniert poliert					

342

Espumadera monobloc. inox 18% cr. / One piece skimmer. 18% cr. St/Steel /
Écumoire monobloc. inox 18% cr. / Schaumlöffel Monoblock. Edelstahl 18 % Cr



REF	Ø cm	L cm	€	U
342.000	11	33	6,65	1
Pulido satinado mate Mat satiny polishing Poli satiné mat Matt satiniert poliert				

343

Espátula monobloc. inox 18% cr. / One piece turner. 18% cr. St/Steel /
Spatule monobloc. inox 18% cr. / Pfannenwender Monoblock. Edelstahl 18 % Cr



REF	L cm	€	U
343.000	33	5,15	1
Pulido satinado mate Mat satiny polishing Poli satiné mat Matt satiniert poliert			

344

Tenedor monobloc. inox 18% cr. / One piece fork. 18% cr. St/Steel /
Fourchette monobloc. inox 18% cr. / Fleischgabel Monoblock. Edelstahl 18 % Cr



REF	L cm	€	U
344.000	30	4,85	1
Pulido satinado mate Mat satiny polishing Poli satiné mat Matt satiniert poliert			

345

Cuchara monobloc. inox 18% cr. / One piece spoon. 18% cr. St/Steel /
Cuillère monobloc. inox 18% cr. / Servieröffel Monoblock. Edelstahl 18 % Cr



REF	L cm	€	U
345.000	34	5,15	1
Pulido satinado mate Mat satiny polishing Poli satiné mat Matt satiniert poliert			

346

Soporte de pared. Acero inox 18/10 / 5-hook rack 18/10 St/Steel /
Support mural 5 crochets. Acier inox 18/10 / Edelstahl Wandhalterung mit 5 Haken

NUEVO MODELO /
NEW MODEL /
NOUVEAU MODÈLE /
NEUES MODELL



REF	L cm	€	U
346.000	33	8,80	1
Pulido brillante Mirror polishing Polissage brillant Glänzend poliert			

3612 Cacillo monobloc. Acero inox 18% cr. / One piece ladle. 18% cr. St/Steel /
Louche monobloc. Acier inox 18% cr. / Schöpplöffel Monoblock. Edelstahl 18 % Cr



REF	Ø cm	L cm	Lts	€	U
361.200	10	37	0,17	10,20	1

3662 Mini-cacillo salsas monobloc. Acero inox 18% cr. / One piece mini sauce ladle. 18% cr. St/Steel /
Mini louche à sauces monobloc. Acier inox 18% cr. / Mini-Sossenlöffel Monoblock. Edelstahl 18 % Cr



REF	Ø cm	L cm	Lts	€	U
366.200	7,5	27	0,06	7,90	1

3622 Espumadera monobloc. Acero inox 18% cr. / One piece skimmer. 18% cr. St/Steel /
Écumoire monobloc. Acier inox 18% cr. / Schaumlöffel Monoblock. Edelstahl 18 % Cr



REF	Ø cm	L cm	Lts	€	U
362.200	11	37		9,00	1

3632 Espátula monobloc. Acero inox 18% cr. / One piece turner. 18% cr. St/Steel /
Spatule monobloc. Acier inox 18% cr. / Pfannenwender Monoblock. Edelstahl 18 % Cr



REF	L cm	€	U
363.200	37	7,90	1
363.201*	37	8,70	1

*Perforada / Perforated / Perforée / Gelocht

3652 Tenedor monobloc. Acero inox 18% cr. / One piece fork. 18% cr. St/Steel /
Fourchette monobloc. Acier inox 18% cr. / Fleischgabel Monoblock. 18 % Cr Edelstahl



REF	L cm	€	U
365.200	35	6,35	1

3642 Cuchara monobloc. Acero inox 18% cr. / One piece spoon. 18% cr. St/Steel /
Cuillère monobloc. Acier inox 18% cr. / Servierlöffel Monoblock. 18 % Cr Edelstahl



REF	L cm	€	U
364.200	35	7,70	1
364.201*	35	8,60	1

*Perforada / Perforated / Perforée / Gelocht

3672 Cuchara spaghetti. Acero inox 18% cr. / Spaghetti server. 18% cr. St/Steel /
Cuillère à spaghetti. Acier inox 18% cr. / Spaghettilöffel. Edelstahl 18 % Cr



REF	L cm	€	U
367.200	35	8,60	1

PINZAS / TONGS / PINCES / ZANGEN

358 BPA FREEPinza buffet BPA Free color / Coloured BPA Free utility tong /
Pince buffet BPA Free couleur / Farbige BPA Free buffetzangen

NUEVO MODELO /
NEW MODEL /
NOUVEAU MODÈLE /
NEUES MODELL



REF	L cm	TRANSPARENTE / CLEAR / TRANSPARENT / TRANSPARENT	BLANCO / WHITE / BLANC / WEISS	ROJO / RED / ROUGE / ROT	NEGRO / BLACK / NOIR / SCHWARZ	€	U
358	23	0	1	2	7	3,30	1

Ref : 358 + L + Color / Colour / Couleur / Farbe

605 Pinza para pasta / Pasta tong /
Pince à pâtes / Nudelzange

REF	L cm	€	U
605.000	24	4,45	1

606 Pinza para pan / Bread tong /
Pince à pain / Brotzange

REF	L cm	€	U
606.000	25	18,30	12

359 Pinza de servicio / Serving tong /
Pince de service / Servierzange

REF	L cm	€	U
359.000	24	7,90	1

353 Pinza ensalada / Salad tong /
Pince à salade / Salatzange

REF	L cm	€	U
353.000	26,5	17,10	1

352 Pinza repostería / Cake tong /
Pince à gâteau / Konditoreizange

REF	L cm	€	U
352.000	18	9,25	1

617 Pinza anillas / Tong with ring /
Pince à anneaux / Zange mit Ringen

REF	L cm	€	U
617.014	14	5,35	1
617.017	17	5,65	1

MÁS PINZAS EN / MORE TONGS ON / PLUSIEURS PINCES EN PAGES / MEHR ZANGEN AUF SEITEN 62-63, 107, 109, 318

351 Pinza spaghetti / Spaghetti tong /
Pince à spaghetti / Spaghettizange



REF	L cm	€	U
351.000	19	3,20	12

3511 Pinza spaghetti reforzada / Reinforced spaghetti tong /
Pince à spaghetti renforcée / Verstärkte Spaghettizange



REF	L cm	€	U
351.100	19	6,35	12

611 Pinza dentada / Pom tong /
Pince ceinture / Gezahnte Zange



REF	L cm	€	U
611.001	24	1,95	24

389 Pinza para mariscos en aluminio /
Aluminium lobster cracker /
Casse-pattes en aluminium /
Meeresfrüchtezange aus Aluminium



REF	L cm	€	U
389.000	14	4,00	1

615 Cascanueces / Nut cracker /
Casse-noix / Nussknacker



REF	L cm	€	U
615.000	16,5	7,05	1

6151 Cascanueces inox / St/Steel nut cracker /
Casse-noix en inox / Edelstahl Nussknacker



REF	L cm	€	U
615.100	16,5	18,30	6

902 Pinza charcutería / Butcher's tong /
Pince à charcuterie / Metzgereizange



REF	cm	€	U
902.000	10,5 x 5	6,25	1

618 Pinza hamburguesa / Burger tong /
Pince à "burger" / Hamburgerzange



REF	L cm	€	U
618.000	24	10,95	1

BANDEJAS PRESENTACIÓN / SERVING TRAYS / PLATEAUX DE SERVICE / SERVIERTABLETTES

317 Fuente oval borde vuelto / Oval serving dish with rolled edge /
Plat ovale à bords ronds / Ovale Serviertablett mit abgerundetem Rand

Pulido satinado
Satin polished
Polissage satiné
Satiniert poliert



REF	cm	€	U
317.025	25 x 17,2	8,70	1
317.030	30 x 20,2	10,65	1
317.035	35 x 23,3	12,90	1
317.040	40 x 26,7	16,15	1
317.045	45 x 29,2	18,00	1
317.050	50 x 31,2	23,40	1

3174 Fuente oval borde vuelto económica / Economical oval serving dish with rolled edge /
Plat ovale à bords ronds économique / Ovale ökonomisches Serviertablett mit abgerundetem Rand

Pulido brillante
Bright polished
Polissage brillant
Glänzend poliert



REF	cm	€	U
317.425	25 x 17,5	6,35	1
317.430	30 x 21	7,15	1
317.435	35 x 24	8,50	1
317.440	40 x 26,5	9,45	1
317.445	45 x 29,5	11,55	1
317.450	50 x 34	14,70	1

3172 Fuente oval borde vuelto / Oval serving dish with rolled edge /
Plat ovale à bords ronds / Ovale Serviertablett mit abgerundetem Rand

Pulido brillante
Bright polished
Polissage brillant
Satiniert poliert



REF	cm	H cm	€	U
317.260	60 x 38,5	3,0	52,35	1
317.280	80 x 40,5	3,5	68,30	1

3171 Fuente de pescado borde vuelto / Fish tray with rolled edge /
Plat à poisson à bords ronds / Ovale Fischserviertablett mit abgerundetem Rand

Pulido brillante
Bright polished
Polissage brillant
Satiniert poliert



REF	cm	H cm	€	U
317.170	70 x 31,5	3	54,25	1

907 Sopera inox con base / St/Steel soup tureen with stand /
Soupière inox avec pied / Edelstahluppenschüssel mit Fuss

REF	Ø cm	Lts	€	U
907.024	24	2,50	15,25	1
907.026	26	3,50	17,40	1

927 Ensaladera acrílica redonda / Acrylic round salad bowl /
Saladier rond acrylique / Runde Acrylsalatschüssel

REF	Ø mm	H mm	€	U
927.000	258	158	27,50	1



928 Ensaladera acrílica cuadrada / Acrylic Squared salad bowl /
Saladier carré acrylique / Quadratische Acrylsalatschüssel

REF	mm	H mm	€	U
928.000	285 x 285	124	14,10	1
928.001	147 x 147	70	2,95	1



Ref. 928.000



Ref. 928.001

903 Placa enfriadora inoxidable 18/10 / 18/10 St/Steel cooling plate /
Plaque réfrigérante en acier inoxydable 18/10 / Kälteplatte Edelstahl 18/10

REF	TIPO/TYPE	mm	€	U
903.001	1/1	530 x 325	170,35	1
903.002	1/2	325 x 265	117,05	1

Para una presentación fácil e higiénica de alimentos fríos en los buffets.
For an easy and hygienic way of cold food presentation.
Pour une présentation hygienique et facile des aliments froids sur les buffets.
Für die einfache und hygienische Präsentation von kalten Lebensmitteln auf den Buffets.



En el congelador: Mínimo 4h por debajo de los -4 °C.
Aguanta 5-6h con temperaturas por debajo de los 23 °C.

In the freezer: Minimum 4h under -4 °C.
Tolerance under 23 °C: 5-6h.

Au congélateur: Minimum 4h à des températures inférieures à -4 °C.
Résistance à des températures inférieures à 23 °C: 5-6h.

Im Gefrierschrank: Mindestens 4h unter -4 °C.
Hält 5-6h Temperaturen unter 23 °C stand.



**BAÑO MARÍA ESPECIAL SERVICIO BUFFET /
SPECIAL BAIN MARIE BUFFET SERVICE /
BAIN-MARIE SPÉCIAL SERVICE BUFFET /
WASSERBAD SPEZIELL FÜR BUFFETSERVICE**



EXCLUSIVE

INDUCTION

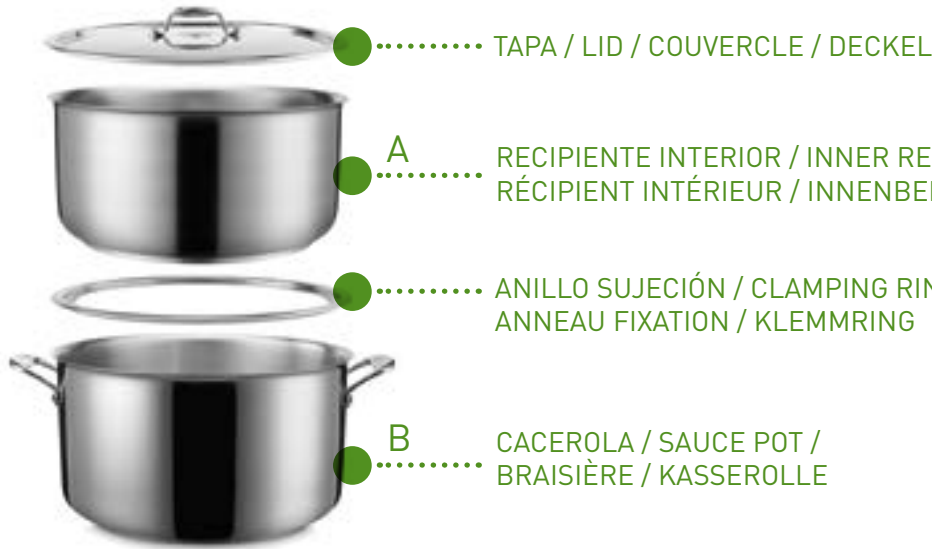

Colores disponibles bajo pedido /
Colours available upon request /
Couleurs disponibles sur commande /
Farben auf Anfrage

8945 Conjunto alto baño maría / High Bain marie set /
Ensemble haut bain-marie / Hohes Wasserbad Set



EXCLUSIVE



REF	Ø cm	H cm	Lts	Lts B Max.	€	U
894.524	A 20	10	3,10	-	147,80	1
	B 24	14	-	1,50		
894.528	A 24	12	5,40	-	181,35	1
	B 28	16	-	2,75		
894.532	A 28	14	8,60	-	201,90	1
	B 32	19	-	3,50		

8946 Conjunto bajo baño maría / Low Bain marie set /
Ensemble bas bain-marie / Flaches Wasserbad Set



EXCLUSIVE



REF	Ø cm	H cm	Lts	Lts B Max.	€	U
894.632	A 28	6	3,70	-	192,05	1
	B 32	12,5	-	5,00		

CHAFING DISHES

379 Chafing dish con tapa / Chafing dish with lid /
Chafing dish avec couvercle / Chafing dish mit Deckel

REF	cm	H cm	Lts	€	U
379.065	65 x 35	34	9,50	204,05	1

Soporte, recipiente, cubeta, tapa y asas de chapa en acero inox.
Con 2 quemadores.
Stand, water pan, insert, lid and St/Steel handles.
With 2 burners.
Support, récipient, bac, couvercle et poignées en acier inox.
Avec 2 brûleurs.
Ständer, Behälter, Wanne, Deckel und Griffe aus Edelstahlblech.
Mit 2 Brennern.

3795 Chafing dish económico con tapa / Economical chafing dish with lid /
Chafing dish économique avec couvercle / Ökonomischer Chafing dish mit Deckel

REF	cm	H cm	Lts	€	U
379.500	60 x 35	32	9,00	104,85	1

Soporte, recipiente, cubeta, tapa y asas de chapa en acero inox.
Con 2 quemadores.
Stand, water pan, insert, lid and St/Steel handles.
With 2 burners.
Support, récipient, bac, couvercle et poignées en acier inox.
Avec 2 brûleurs.
Ständer, Behälter, Wanne, Deckel und Griffe aus Edelstahlblech.
Mit 2 Brennern.

387 Chafing dish con tapa tipo roll top / Chafing dish with roll top lid /
Chafing dish avec couvercle roll top / Chafing dish mit Rolldeckel

REF	cm	H cm	Lts	€	U
387.065	65 x 38	39	9,50	258,40	1

Soporte, recipiente, cubeta, tapa y asas de chapa en acero inox.
Con 2 quemadores.
Stand, water pan, insert, lid and St/Steel handles.
With 2 burners.
Support, récipient, bac, couvercle et poignées en acier inox.
Avec 2 brûleurs.
Ständer, Behälter, Wanne, Deckel und Griffe aus Edelstahlblech.
Mit 2 Brennern.

3875 Chafing dish rectangular con tapa roll top / Rectangular chafing dish roll top lid /
Chafing dish rectangulaire avec couvercle roll top / Rechteckiger Chafing dish mit Rolldeckel

REF	cm	H cm	Lts	€	U
387.500	74 x 45	41	9,00	344,15	1

Soporte, recipiente, cubeta, tapa y asas de chapa en acero inox.
Con 2 quemadores.
Stand, water pan, insert, lid and St/Steel handles.
With 2 burners.
Support, récipient, bac, couvercle et poignées en acier inox.
Avec 2 brûleurs.
Ständer, Behälter, Wanne, Deckel und Griffe aus Edelstahlblech.
Mit 2 Brennern.

8975 Chafing dish redondo tapa roll top / Round chafing dish roll top lid /
Chafing dish rond avec couvercle roll top / Runder Chafing dish mit Rolldeckel



REF	Ø A cm	Ø B cm	H cm	Lts	€	U
897.500	35	51,5	48,5	6,00	307,35	1

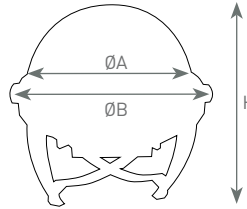

Apertura máxima: 180°
Max. opening: 180°
Ouverture maximale: 180°
Max. Öffnung: 180°

897 Chafing dish Redondo tapa roll top y pies dorados / Round Chafing dish with roll top lid and golden legs / Chafing dish rond avec couvercle roll top et pieds dorés / Runder Chafing dish mit Rolldeckel und vergoldeten Füßen



REF	Ø A cm	Ø B cm	H cm	€	U
897.000	35	45	45	538,40	1

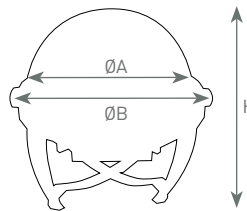

Apertura máxima: 180°
Max. opening: 180°
Ouverture maximale: 180°
Max. Öffnung: 180°

Patas de latón dorado
Golden brass legs
Pieds en laiton doré
Vergoldete Messingbeine

898 Chafing dish rectangular tapa roll top y pies dorados / Rectangular chafing dish with roll top lid and golden legs / Chafing dish rectangulaire avec couvercle roll top et pieds dorés / Rechteckiger Chafing dish mit Rolldeckel und vergoldeten Füßen



REF	A cm	B cm	H cm	€	U
898.000	76,9	50	41	594,80	1

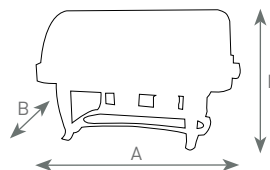

Apertura máxima: 180°
Max. opening: 180°
Ouverture maximale: 180°
Max. Öffnung: 180°

Patas de latón dorado
Golden brass legs
Pieds en laiton doré
Vergoldete Messingbeine

Soporte, recipiente, cubeta y tapa en acero inox.
Con 2 quemadores.

Stand, water pan, insert and St/Steel lid.
With 2 burners.

Support, récipient, bac et couvercle en acier inox.
Avec 2 brûleurs.

Ständer, Behälter, Wanne, Deckel und Griffe aus
Edelstahlblech. Mit 2 Brennern.

CHAFING DISHES

9500 Elemento eléctrico para chafing dish / Electric heating unit for chafing dish /
Corps de chauffe pour chafing dish / Elektrisches Element für chafing dish

REF	W	€	U
950.000	240	182,10	1

Adaptable a las referencias 379 y 387
Adaptable to ref. 379 and 387
Adaptable aux réf. 379 et 387
Geeignet für Art.Nr. 379 und 387

**3871 / 3872** Fuel para chafing dish / Chafing dish fuel /
Fuel pour chafing dish / Brennstoff für chafing dish

REF	mm	DURACIÓN / LENGHT / DUREE / DUAER	€	U
387.100	65 x 55	3 h	1,90	75
387.200	83 x 60	6 h	3,90	60

Gracias a su fórmula especial no hay ninguna restricción especial por almacenaje o transporte
No gotea ni se derrama.
No se evapora si se deja abierto.
Puede guardarse si no se consume todo.
No inflamable.
No tóxico.
Fácil de abrir y cerrar.
La lata no se calienta.
Fácil de encender una vez apagada.

Thanks to its special formula no storage or transport restriction are involved
Resealable.
Non spill - Non drip.
Non flammable.
Non combustible.
Non toxic fuel.
Easy open & close.
Container does not become hot to touch.
Does not evaporate if left uncapped.

Grâce à sa formule spéciale il n'y pas de restriction pour le stockage et le transport
Hermétique.
Non inflammable
Non combustible.
Non toxique.
Facile à ouvrir et fermer.
On peut le garder si on ne le consomme pas tout.
Facile à allumer une fois éteint.

Dank seiner speziellen Formel gibt es keinerlei spezielle Beschränkung für den Transport oder Lagerung.
Wiederverschliessbar.
Keine Verdampfung beim Auflassen.
Wiederverwendbar bei nicht vollständigem Verbrauch.
Nicht leicht entzündbar.
Nicht giftig.
Einfach zu öffnen und verschliessen.
Die Dose erhitzt sich nicht.
Einfach anzuzünden einmal ausgegangen.

3722 Contenedor para combustible de chafing dish / Burner holder for chafing dish /
Porte-brûleur pour chafing dish / Brennstoffbehälter für chafing dish

REF	€	U
372.200	8,20	1

Adaptable a las referencias 379, 387, 898 y 8991
Adaptable to ref. 379, 387, 898 and 8991
Adaptable aux réf. 379, 387, 898 et 8991
Geeignet für Ref. 379, 387, 898 und 899

685 Fuel para chafing dish / Chafing dish fuel barrel /
Bidon fuel chafing dish / Brennstoff für chafing dish

Ref.685.004



Ref.685.100

REF	Lts	Kg	€	U
685.004	5	4	31,45	1
685.100	DISPENSADOR / DISPENSER / POMPE DISTRIBUTRICE / SPENDER		13,50	1

8992 Dispensador de zumos - acero inox / Juice dispenser St/Steel /
Distributeur à jus - acier inox / Saftspender - Edelstahl

REF		Lts	€	U
899.000	Pie dorado / Golden leg / Pied doré / Vergoldeter Fuss	6,00	297,95	1
899.200		8,00	230,70	1
899.202		8,00 x 2,00	450,90	1

Ref. 899.200

Ref. 899.202

8993 Dispensador de leche - acero inox / St/Steel milk dispenser /
Distributeur à lait - acier inox / Milchspender Edelstahl

REF		Lts	€	U
899.300		8,00	251,70	1
899.302		8,00 x 2,00	482,40	1

Ref. 899.300

Ref. 899.302

9100 Olla eléctrica para buffet / Soup kettle / Marmite buffet chaud / Elektrischer Buffettopf

REF	cm	Lts	€	U
910.008	34 x 39	10,00	139,70	1



Piezas de repuesto:
Container interior inox. Resistencia.
Termostato. Control temperatura.
Conjunto piloto neón. Tapa.
Termostato regulador de temperatura
Resistencia 400 W, 1,9 amperios,
230 V monofase, 50/60 Hz
Tapa de acero inox
Cuerpo de aluminio con baño epoxy
Cuba interior de acero inox. con
capacidad para 10 litros.

Spare parts:
Inside container. Resistance.
Thermostat. Temperature control.
Light set. Lid.
Thermostat to regulate the
temperature
Resistance 400 W, 1,9 amperes, 230 V
single phase, 50/60 Hz
St/Steel lid
External aluminium body with epoxy
coating
Inside pool St/Steel, 10 lts. capacity.

Pièces de rechange:
Conteneur intérieur inox. Résistance.
Thermostat. Contrôle de température.
Indicateur néon. Couvercle.
Thermostat pour le réglage de la
température
Résistance 400 W, 1,9 ampères,
230 V monophasée, 50/60 Hz
Couvercle en acier inox
Corps en aluminium laqué epoxy
Cuve intérieure en acier inox. capacité
10 lts.

Austauschbare Teile:
Innenbehälter Edelstahl.
Heizelement. Thermostat.
Temperaturkontrolle.
Kotrolleuchten. Deckel.
Thermostat regulierbar
Heizelement 400W, 1,9 A, 230V,
50/60 Hz
Edelstahldeckel, Aluminiumkörper
mit Epoxybeschichtung.
Innenbehälter aus Edelstahl mit
Fassungsvermögen von 10 Liter.

BAMBÚ NATURAL & MADERA / NATURAL BAMBOO & WOOD
BAMBOU NATUREL & BOIS / NATURBAMBUS & HOLZ



NATURAL
FIBERS

..... ESPAÑOL
GAMA PRESENTACIÓN BAMBÚ NATURAL PARA LOS MÁS EXIGENTES.
..... ENGLISH
NATURAL BAMBOO PRESENTATION RANGE FOR THE MOST DEMANDING.
..... FRANÇAIS
GAMME DE PRÉSENTATION BAMBOU NATUREL PLUS EXIGEANTS .
..... DEUTSCH
PRÄSENTATIONSREIHE NATURBAMBUS FÜR DEN HÖCHSTEN ANSPRUCH.

10050 Tabla curvada bambú presentación sushi / Curved bamboo sushi board /
Planche bamboú incurvée présentation sushi / Gebogenes Bambus Sushitablett



REF	cm	H cm	€	U
100.500	24,5 x 15	3,0	17,75	1
100.501	32 x 18	3,0	22,70	1
100.502	40 x 23	3,0	39,05	1
100.503	47 x 27,5	3,0	56,75	1

Tabla bambú presentación sushi /
Bamboo sushi board /

10051 Planche bamboú présentation sushi /
Bambus Sushitisch



REF	cm	H cm	€	U
100.510	21 x 12	3,0	8,60	1
100.511	24 x 15	3,0	10,80	1
100.512	27 x 18	3,0	13,50	1

Tabla curvada bambú sushi /
Curved bamboo sushi board /

10052 Planche incurvée bambou présentation sushi /
Gebogener Bambus Sushitisch



REF	cm	H cm	€	U
100.520	21 x 12	2,5	9,25	1
100.521	24 x 15	3,0	11,30	1
100.522	27 x 18	3,0	14,00	1

10060 Barco presentación sushi / Sushi boat presentation /
Bateau présentation sushi / Präsentations Sushi-Boot



REF	cm	H cm	€	U
100.600	50 x 20	31,0	88,70	1
100.601	70 x 25,5	45,0	118,30	1

10054 Vaporera bambú redonda /
Round bamboo steamer /
Cuit vapeur bambou ronde /
Runder Bambus Dampfgarer



Sin tapa /
Without lid /
Sans couvercle /
Ohne Deckel

REF	Ø cm	H cm	€	U
100.540	10	4,0	3,45	1
100.541	13	5,0	5,05	1
100.542	15	5,0	5,15	1
100.543	21	5,0	6,45	1
100.544	27	5,5	9,25	1

10055 Tapa vaporera redonda /
Round steamer lid /
Couvercle cuit vapeur ronde /
Runder Dampfgarerdeckel



REF	Ø cm	H cm	€	U
100.550	10	3,0	3,25	1
100.551	13	3,5	4,55	1
100.552	15	3,5	4,80	1
100.553	21	4,0	5,80	1
100.554	27	4,0	8,60	1

10053 Bandeja rectangular presentación sushi / Rectangular tray for serving sushi /
Plateau rectangulaire présentation sushi / Sushi-Tablett, rechteckig



REF	cm	H cm	€	U
100.530	33 x 22,5	8,0	33,55	1
100.531	42 x 32	8,5	37,05	1

10057 Pinza bambú / Bamboo tong /
Pince bambou / Bambuszange

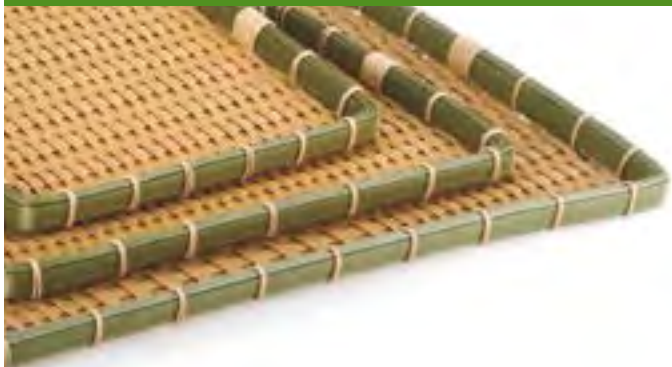

REF	L cm	€	U
100.570	20,0	1,20	1
100.571	25,5	1,35	1
100.572	30,0	1,50	1

BAMBÚ POLIPROPILENO / POLYPROPYLENE BAMBOO /
BAMBOU POLYPROPYLÈNE / BAMBUS POLYPROPYLEN**10063** Cedazo presentación / Presentation sieve /
Tamis présentation / Präsentationssieb

REF	Ø cm	H cm	€	U
100.630	18	6,0	5,70	1
100.631	21	6,0	6,45	1

10065 Bandeja cuadrada /
Square tray /
Plateau carré /
Quadratisches Tablett

REF	cm	H cm	€	U
100.650	16 x 16	2,0	5,05	1

10067 Cesta redonda alta / High round basket /
Corbeille haute ronde / Hoher runder Korb

REF	Ø cm	H cm	€	U
100.670	10	4,0	4,70	1
100.671	15	4,5	8,00	1
100.672	18	5,0	9,95	1
100.673	30	7,0	17,30	1
100.674	40	8,0	24,75	1

..... ESPAÑOL
CESTAS DE POLIPROPILENO TRENZADAS A MANO, CON
REFUERZO DE ACERO INOXIDABLE EN SU INTERIOR

..... ENGLISH
HAND MADE POLYPROPYLENE WICKERWARE WITH ST/
STEEL REINFORCEMENT RIM

..... FRANÇAIS
CORBEILLES EN POLYPROPYLÈNE TRÉSSÉES À LA MAIN,
AVEC RENFORT EN ACIER INOXYDABLE À L'INTÉRIEUR

..... DEUTSCH
HANDGEMACHTE KÖRBE AUS POLYPROPYLEN, MIT
VERSTÄRKUNGSDRÄHTEN AUS ROSTFREIEM STAHL

10064 Bol presentación / Presentation bowl /
Bol présentation / Präsentationschale

REF	Ø cm	H cm	€	U
100.640	20	10,0	8,90	1

10066 Bandeja cuadrada con pies /
Square tray with legs /
Plateau carré avec pieds /
Quadratisches Tablett mit Füßen

REF	cm	H cm	€	U
100.660	16 x 16	3,0	5,55	1
100.661	18 x 18	3,0	6,20	1
100.662	22 x 22	3,0	6,95	1

10068 Cesta redonda / Round basket /
Corbeille ronde / Runder Korb

REF	Ø cm	H cm	€	U
100.680	21	3,0	12,95	1
100.681	30	3,0	14,00	1
100.682	40	3,0	17,40	1
100.683	50	3,0	21,25	1
100.684	60	3,0	31,60	1

10069 Cesta cuadrada alta / High square basket /
Corbeille haute carrée / Quadratischer hoher Korb



REF	cm	H cm	€	U
100.690	30 x 30	6,0	21,25	1
100.691	40 x 30	6,0	27,15	1
100.692	45 x 30	10,0	31,60	1
100.693	60 x 45	10,0	43,90	1

10070 Cesta cuadrada / Square basket /
Corbeille carrée / Quadratischer Korb



REF	cm	H cm	€	U
100.700	30 x 23	3,0	14,80	1
100.702	30 x 30	3,0	16,35	1
100.701	40 x 30	3,0	19,35	1

10071 Pala presentación / Presentation peel /
Pelle présentation / Präsentationschaufel



REF	cm	H cm	€	U
100.713	12 x 10	4,7	4,70	1
100.712	18 x 15	6,0	7,05	1
100.714	23 x 19	5,5	8,60	1
100.710	30 x 30	12,0	16,80	1
100.711	40 x 40	16,0	21,25	1

10072 Cesta oval grande / Big oval basket /
Corbeille ovale grande / Grosser ovaler Korb



REF	cm	H cm	€	U
100.720	60 x 46	2,5	29,60	1

10073 Cesta de baguettes / Baguette basket /
Corbeille à baguettes / Baguettekorb



REF. 100.730

REF. 100.731

REF	Ø cm	H cm	€	U
100.730	32	35,5	50,40	1
100.731	32	35,5	50,40	1

CESTAS POLIPROPILENO / POLYPROPYLENE BASKETS /
CORBEILLES POLYPROPYLÈNE / POLYPROPYLEN KÖRBE

906.100 / 906.150

Dispensador de pan / Bread dispenser /
Présentoir à pain / Brotbehälter



EXCLUSIVE

REF	mm	H mm	€	U
906.100	355 x 500	1600	650,80	1
906.150	355 x 500	1600	613,20	1



Ref. 906.100

Ref. 906.150

Para cestas 10075 i 10078 /
For baskets 10075 i 10078 /
Pour corbeilles 10075 i 10078 /
Für Körbes 10075 i 10078

Ver en página / Refer to page /
Consulter page / Siehe Seite : 285

No incluye cestas.
Baskets not included.
Corbeilles non inclus.
Körbe nicht inklusive.

Incluye dos ruedas posteriores.
Includes two rear castors.
Pourvu de deux roues arrières.
Enthält zwei Hinterräder.

10074 Cesta pan / Bread basket /
Corbeille à pain / Brotkorb

REF	cm	H cm	€	U
100.740	29 x 29	47,5	50,05	1
100.741	36 x 30	21 / 39	37,30	1
100.742	Ø 29	21 / 39	37,30	1



REF. 100.740



REF. 100.741



REF. 100.742

10075 Cesta redonda inclinada / Slanted round basket /
Corbeille ronde inclinée / Schräger runder Korb



REF	Ø cm	H cm	€	U
100.750	36	10 / 20	18,45	1
100.751	40	13 / 23	23,70	1
100.752	36	10 / 20	18,45	1
100.753	40	13 / 23	23,70	1
100.754	36	10 / 20	18,45	1
100.755	40	13 / 23	23,70	1

10076 Cesta rectangular inclinada / Slated rectangular basket /
Corbeille rectangulaire inclinée / Schräger rechteckiger Korb



REF	cm	H cm	€	U
100.760	40 x 28	6 / 10	23,30	1
100.761	58 x 38	8 / 12	37,80	1

10077 Cesta rectangular dos compartimentos / Two compartments rectangular basket /
Corbeille rectangulaire deux compartiments / Rechteckiger Korb zwei Unterteilungen



REF	cm	H cm	€	U
100.770	49 x 31	10 / 14,3	32,60	1

10078 Cesta baguettes / Baguette basket /
Corbeille à baguettes / Baguettekorb



REF. 100.780

REF. 100.781

REF	Ø cm	H cm	€	U
100.780	35	35	28,60	1
100.781	36	36	26,95	1

**CESTAS POLIPROPILENO / POLYPROPYLENE BASKETS /
CORBEILLES POLYPROPYLÈNE / POLYPROPYLEN KÖRBE**
10079 Cesta redonda / Round basket /
Corbeille ronde / Runder Korb

REF	Ø cm	H cm	€	U
100.790	31	7,0	11,90	1
100.791	34,5	6,5	14,00	1
100.792	24	5,5	7,15	1
100.793	28	6,0	9,20	1

10080 Cesta redonda / Round basket /
Corbeille ronde / Runder Korb

REF	Ø cm	H cm	€	U
100.800	18,5	7,5	5,45	1
100.801	23	8,0	5,90	1
100.802	24	7,0	7,40	1
100.803	18	6,0	5,90	1
100.804	23	6,0	7,90	1
100.805	25	6,0	8,80	1

10081 Cesta redonda / Round basket /
Corbeille ronde / Runder Korb

REF	Ø cm	H cm	€	U
100.810	19,5	7,5	3,95	1
100.811	22	6,0	4,95	1
100.812	26	7,5	5,20	1
100.813	18,5	6,0	3,95	1
100.814	23	6,0	4,95	1
100.815	25,5	6,0	5,20	1

10082 Cesta redonda / Round basket /
Corbeille ronde / Runder Korb

REF	Ø cm	H cm	€	U
100.820	18,5	6,0	3,95	1
100.821	23	6,0	4,95	1
100.822	25,5	6,0	5,20	1

CESTAS POLIPROPILENO / POLYPROPYLENE BASKETS /
CORBEILLES POLYPROPYLÈNE / POLYPROPYLEN KÖRBE

10083 Cesta rectangular / Rectangular basket /
Corbeille rectangulaire / Rechteckiger Korb



REF	cm	H cm	€	U
100.830	37 x 24,5	4,0	14,50	1
100.831	41,5 x 30	4,0	17,10	1

10084 Cesta rectangular / Rectangular basket /
Corbeille rectangulaire / Rechteckiger Korb



REF	cm	H cm	€	U
100.840	21,5 x 18	8,0	7,15	1
100.841	26 x 20	7,5	6,45	1
100.842	23 x 23	9,0	7,70	1

10085 Cesta rectangular / Rectangular basket /
Corbeille rectangulaire / Rechteckiger Korb



REF	cm	H cm	€	U
100.850	30 x 22	6,0	12,35	1
100.851	40 x 28,5	7,0	17,20	1

10086 Cesta rectangular / Rectangular basket /
Corbeille rectangulaire / Rechteckiger Korb



REF	cm	H cm	€	U
100.860	37 x 27	7,0	15,15	1
100.861	46 x 34	7,0	20,50	1
100.862	46 x 34	12,0	24,75	1

10087 Cesta rectangular / Rectangular basket /
Corbeille rectangulaire / Rechteckiger Korb



REF	cm	H cm	€	U
100.870	37 x 26	7,0	15,15	1
100.871	42 x 30	7,0	20,50	1
100.872	46 x 34	7,0	24,75	1

**CESTAS POLIPROPILENO / POLYPROPYLENE BASKETS /
CORBEILLES POLYPROPYLÈNE / POLYPROPYLEN KÖRBE**
10088 Cesta oval / Oval basket /
Corbeille ovale / Ovaler Korb

REF	cm	H cm	€	U
100.880	18 x 12	6,5	4,45	1
100.881	23,5 x 15	7,0	5,50	1
100.882	28 x 14,5	7,5	6,95	1

10089 Cesta oval / Oval basket /
Corbeille ovale / Ovaler Korb

REF	cm	H cm	€	U
100.890	19 x 13	7,0	5,20	1
100.891	25 x 15	8,0	7,15	1
100.892	29 x 19	10,0	8,10	1

10090 Cesta oval / Oval basket /
Corbeille ovale / Ovaler Korb

REF	cm	H cm	€	U
100.900	30 x 23,5	7,5	7,90	1
100.901	36 x 27,5	9,0	9,85	1
100.902	41 x 31	9,0	14,80	1

10091 Cesta oval / Oval basket /
Corbeille ovale / Ovaler Korb

REF. 100.910

REF. 100.911

REF	cm	H cm	€	U
100.910	31 x 25	15,0	24,75	1
100.911	31 x 25	15,0	24,75	1

10092 Cesta oval / Oval basket /
Corbeille ovale / Ovaler Korb

REF. 100.920

REF. 100.921

REF	cm	H cm	€	U
100.920	28 x 21	15,0	9,85	1
100.921	28 x 21	15,0	9,85	1

10093 Cesta para cubiertos / Cutlery dispenser /
Corbeille à couverts / Besteckkorb



REF	cm	H cm	€	U
100.930	28 x 11	5,0	6,25	1
100.931	29 x 11	7,0	7,25	1
100.932	30 x 11	7,0	7,25	1

10094 Cesta para cubiertos / Cutlery dispenser /
Corbeille à couverts / Besteckkorb



REF	Ø cm	H cm	€	U
100.940	13	14,0	5,90	1

10095 Cesta buffet rectangular / Rectangular buffet basket /
Corbeille rectangulaire buffet / Rechteckiger Buffetkorb



REF	cm	H cm	€	U
100.950	53 x 31,5	26,0	29,10	1
100.951	53 x 31,5	26,0	29,10	1
100.955	Tapa PC / PC Lid / Couv PC / PC Deckel		54,25	1

10096 Cesta buffet redonda / Round buffet basket /
Corbeille ronde buffet / Runder Buffetkorb



REF	Ø cm	H cm	€	U
100.960	40	30	18,95	1
100.965	Tapa PC / PC Lid / Couv PC / PC Deckel		28,70	1

10097 Bandeja oval madera con tapa / Oval wooden tray with cover /
Plateau ovale en bois + couvercle / Ovale Holzplatte mit Deckel



REF	cm	H cm	€	U
100.970	26 x 20	13,0	29,60	1
100.971	30 x 24	15,0	34,70	1

MELAMINA / MELAMINE / MÉLAMINE / MELAMIN

MELAMINA Y PRESENTACIÓN / MELAMINE & PRESENTATION / MÉLAMINE ET PRÉSENTATION / MELAMIN UND PRÄSENTATION



ESPAÑOL

LA MELAMINA ES UNA RESINA SINTÉTICA QUE SE ENDURECE Y TOMA FORMA DESPUÉS DE UN PROCESO DE CALENTAMIENTO. ES UN MATERIAL MUY UTILIZADO EN EL SERVICIO DE MESA Y PRESENTACIÓN POR SUS PROPIEDADES.

ENGLISH

MELAMINE IS A SYNTHETIC RESIN WHICH BECOMES HARDEN AND FORMED AFTER HEATING. IT IS HIGHLY RECOMMENDED FOR TABLE & BUFFET SERVICE FOR ITS PROPERTIES.

FRANÇAIS

LA MÉLAMINE EST UNE RÉSINE SYNTHÉTIQUE QUI SE DURCIT ET PREND-FORME APRÈS UN PROCESSUS SPÉCIAL DE CHAUFFEMENT. TRÈS UTILISÉE DANS LE SERVICE DE TABLE ET BUFFET PAR SES PROPERTIES.

DEUTSCH

MELAMIN IST EIN KUNSTHARZ, WELCHES SICH VERHÄRTET UND NACH EINEM ERHITZUNGSPROZESS EINE FORM ANNIMMT. AUFGRUND SEINER EIGENSCHAFTEN IST ES EIN VIELBENUTZTES MATERIAL FÜR DEN TISCHSERVICE UND DIE PRÄSENTATION.

CARACTERÍSTICAS / MAIN FEATURES / PRINCIPALES CARACTÉRISTIQUES / PRODUKTMERKMALE

CONTACTO CON ALIMENTOS: CERTIFICADO POR SGS
CONDICIONES DE TRABAJO: ENTRE -20°C Y +70°C

FOOD CONTACT APPROVED: CERTIFIED BY SGS
WITHSTANDS TEMPERATURES: -20°C & +70°C

CONTACT AVEC ALIMENTS: CERTIFIÉ PAR SGS
TEMPÉRATURES ENTRE: -20°C ET +70°C

KONTAKT MIT LEBENSMITTELN: ZERTIFIZIERT
DURCH SGS
ARBEITSTEMPERATUREN: ZWISCHEN -20°C
UND +70°C

PROPIEDADES / PROPERTIES / PROPRIÉTÉS / EIGENSCHAFTEN

RESISTENTE AL CALOR
RESISTENTE A LA CORROSIÓN

NO TÓXICO
INODORO
LIGERO E INDEFORMABLE
POCO CONDUCTOR DEL CALOR

HEAT RESISTANT
CORROSION RESISTANT
NON-TOXIC
NON-ODOROUS
LIGHT WEIGHT AND FREE FORM DEFORMATION
LOW HEAT CONDUCTIVITY

RÉSISTANTE À LA CHALEUR
RÉSISTANTE À LA CORROSION
NON-TOXIQUE
INODORE
LÉGÈRE ET INDÉFORMABLE
BAISSE CONDUCTIVITÉ DE LA CHALEUR

HITZEBESTÄNDIG, RESISTENT GEGEN
KORROSION, NICHT GIFTIG, GERUCHLOS,
LEICHT UND UNVERFORMBAR,
GERINGE WÄRMELEITUNG

USOS / USES / USAGES / GEBRAUCH

NO RECOMENDADA / NOT RECOMMENDED /
NON RECOMMANDÉE / NICHT EMPFHOLEN

MICROONDAS
HORNO
DIRECTO AL FUEGO
ACEITE Y PRODUCTOS QUÍMICOS

MICROWAVE
OVEN
DIRECT FLAME
OIL AND CHEMICAL PRODUCTS

MICRO-ONDES
FOUR
DIRECT AU FEU
HUILE OU PRODUITS CHIMIQUES

MIKROWELLEN
ÖFEN
DIREKTE FLAMME
ÖL UND CHEMISCHE PRODUKTE



ESPAÑOL

EXCLUSIVA GAMA DE TABLAS DE MELAMINA DONDE LA APARIENCIA Y EL TACTO HACEN QUE LA IMITACIÓN DE ROBLE VIEJO SEA PRÁCTICAMENTE PERFECTA. PARA UNA PRESENTACIÓN ELEGANTE.

ENGLISH

EXCLUSIVE RANGE OF MELAMINE BOARDS SIMILAR TO OAK THANKS TO ITS APPEARANCE AND ITS TOUCH. IDEAL FOR A NICE PRESENTATION.

FRANCAIS

GAMME EXCLUSIVE DE TABLETTES DE MÉLAMINE DONT L'APPARENCE ET LE TOUCHER RESSEMBLENT TRÈS FORTEMENT AU BOIS DE CHÊNE. IDÉAL POUR UNE PRÉSENTATION ÉLÉGANTE.

DEUTSCH

EXCLUSIVE SERIE VON MELAMINPLATTEN, WELCHE DURCH IHRE ÄUSSERE ERSCHEINUNG UND DER OBERFLÄCHE DER RUSTIKALEN EICHE PRAKTISCH PERFECT ÄHNELT. FÜR EINE ELEGANTE PRÄSENTATION.

2265 Pala horno roble / Oven oak peel / Pelle four chêne / Backofenschaufel Eiche



REF	mm	€	U
22650	Ø 300	27,45	6
22651	530 x 200	31,05	6
22652	610 x 200	36,75	6

2260 Soporte presentación roble / Oak display plate / Présentoir chêne / Präsentationsständer Eiche



REF	MOD.	mm	€	U
22600	1/1	530 x 325	49,45	1
22601	1/2	325 x 265	26,10	6
22602	1/3	325 x 176	18,45	6
22603	1/4	265 x 162	15,25	6
22604	2/4	530 x 165	24,45	1
22605		500 x 250	33,10	1
22606		250 x 150	13,60	1



Con pies antideslizantes
With non-slip feet
Avec pieds antidérapants
Mit Antirutschfüßen

2262 Bandeja presentación roble / Oak serving tray / Plateau présentation bois / Eichentablett



REF	mm	H mm	€	U
22620	300 x 150	18	11,15	12
22621	300 x 200	18	13,35	12
22622	300 x 300	18	19,55	6



MELAMINA / MELAMINE / MÉLAMINE / MELAMIN

2261 Soporte presentación / Display plate /
Présentoir / Präsentationsplatte

REF	MOD.	mm	BLANCO / WHITE / BLANC / WEISS	NEGRO / BLACK / NOIR / SCHWARZ	€	U
22610	1/1	530 x 325	B	N	49,45	1
22611	1/2	325 x 265	B	N	26,10	6
22612	1/3	325 x 176	B	N	18,45	6
22613	1/4	265 x 162	B	N	15,25	6
22614	2/4	530 x 165	B	N	24,45	1
22615		500 x 250	B	N	33,10	1
22616		250 x 150	B	N	13,60	1



Con pies antideslizantes REF + código color
With non-slip feet REF + color code
Avec pieds antidérapants REF + code couleur
Mit Antirutschfüßen REF + Farbcode

2264 Bandeja base pizarra / Slate display plate /
Présentoir base ardoise / Präsentationstablent Schiefertafel

REF	MOD.	mm	BLANCO / WHITE / BLANC / WEISS	NEGRO / BLACK / NOIR / SCHWARZ	€	U
22640	1/2	325 x 265	B	N	26,40	6
22641	1/3	325 x 175	B	N	18,45	6
22642	1/4	265 x 160	B	N	15,25	6



Con pies antideslizantes REF + código color
With non-slip feet REF + color code
Avec pieds antidérapants REF + code couleur
Mit Antirutschfüßen REF + Farbcode

22161 Soporte presentación Pizarra-granito /
Slate-granite Display plate /
Presentoir Ardoise-granite /
Präsentationsplatte Schiefer-Granit

REF	MOD.	mm	H mm	€	U
22161	1/1	530 x 325	7,0	40,40	3
22162	1/2	325 x 265	7,0	19,10	3

Reversible: 1 cara pizarra - 1 cara granito
Reversible: 1 slate side - 1 granite side
Réversible: 1 face ardoise - 1 face granite
Reversibel: 1 Seite Schiefer - 1 Seite Granit

2267 Pala horno pizarra / Slate oven peel /
Pelle four ardoise / Ofenschieber, Schiefer

REF	Ø mm	L mm	H mm	€	U
22670	230	320	15	14,50	1
22671	300	430	15	27,60	1
22672	380	530	15	45,60	1

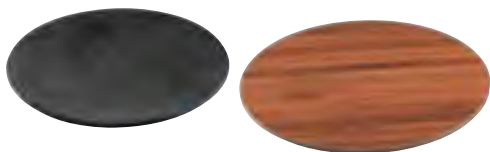
22144 Soporte presentación doble cara pizarra-bambú /
Double face slate-bamboo display plate /
22145 Présentoir double face bambou-ardoise /
Zweiseitige Präsentationsplatte Schiefer-Bambus

REF	Ø mm	H mm	€	U
22144	330	10	35,70	6
22145	430	10	52,45	6

22017 Soporte "mármol" / "Marble" display plate /
22018 Plateau "Marbre" / "Marmor" Platte

REF. 22017



REF. 22018

REF	mm	H mm	€	U
22017	590 x 240	24	47,85	3
22018	360	20	24,25	6

GN 1/1

530 x 325 mm

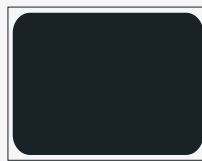

REF	H mm	€	U
22052	20	17,70	6
22054	40	25,15	3
22006	65	38,85	2

GN 1/1 DOUBLE

530 x 325 mm



REF	H mm	€	U
22089	65	50,50	2

GN 2/3

353 x 325 mm



REF	H mm	€	U
22048	65	30,95	3

GN 1/2

325 x 265 mm

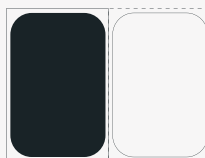

REF	H mm	€	U
22040	20	9,45	6
22042	40	17,30	3
22007	65	20,35	3
22083	100	25,80	3

GN 2/4

530 x 162 mm



REF	H mm	€	U
22087	20	19,00	6
22050	65	23,10	3

GN 1/3

325 x 175 mm

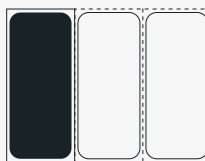

REF	H mm	€	U
22008	65	15,05	3
22079	100	20,05	3

GN 1/4

265 x 162 mm



REF	H mm	€	U
22044	65	14,50	3

GN 1/6

176 x 162 mm

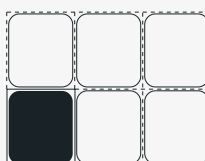

REF	H mm	€	U
22046	65	10,30	6
22081	100	14,20	6

MELAMINA / MELAMINE / MÉLAMINE / MELAMIN

GN 1/1

530 x 325 mm

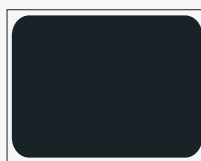

REF	H mm	€	U
22051	20	17,70	6
22053	40	25,15	3
22009	65	38,85	2

GN 2/3

353 x 325 mm



REF	H mm	€	U
22047	65	41,75	3

GN 1/2

325 x 265 mm

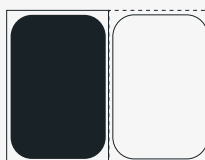

REF	H mm	€	U
22039	20	9,45	6
22041	40	17,30	3
22010	65	20,35	3
22084	100	25,80	3

GN 2/4

530 x 162 mm

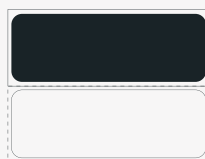

REF	H mm	€	U
22049	65	23,10	3

GN 1/3

325 x 175 mm

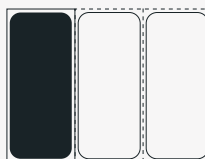

REF	H mm	€	U
22011	65	15,05	3
22080	100	20,05	3

GN 1/4

265 x 162 mm



REF	H mm	€	U
22043	65	14,50	3

GN 1/6

176 x 162 mm

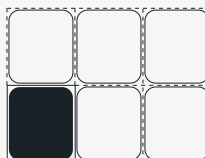

REF	H mm	€	U
22045	65	10,30	6
22082	100	14,20	6

GN 1/1

530 x 325 mm



Rojo / Red / Rouge / Rot

REF	H mm	€	U
22055	20	18,80	6
22056	40	26,55	3
22057	65	42,70	2

Amarillo / Yellow / Jaune / Gelb

REF	H mm	€	U
22058	20	18,80	6
22059	40	26,55	3
22060	65	42,70	2

Verde / Green / Vert / Grün

REF	H mm	€	U
22061	20	18,80	6
22062	40	26,55	3
22063	65	42,70	2

Azul / Blue / Bleu / Blau

REF	H mm	€	U
22064	20	18,80	6
22065	40	26,55	3
22066	65	42,70	2

GN 1/2

325 x 265 mm



Rojo / Red / Rouge / Rot

REF	H mm	€	U
22067	20	10,00	6
22068	40	18,30	3
22069	65	22,50	2

Amarillo / Yellow / Jaune / Gelb

REF	H mm	€	U
22070	20	10,00	6
22071	40	18,30	3
22072	65	22,50	2

Verde / Green / Vert / Grün

REF	H mm	€	U
22073	20	10,00	6
22074	40	18,30	3
22075	65	22,50	2

Azul / Blue / Bleu / Blau

REF	H mm	€	U
22076	20	10,00	6
22077	40	18,30	3
22078	65	22,50	2

22152

Cubeta GN curvada / Curved GN pan / GN courbé / Kurviger GN Behälter



REF	mm	H mm	€	U
22152	535 x 265 (GN 1/1)	65	22,70	2
22153	330 x 265 (GN 1/2)	65	13,65	3

22159

Stand GN curvado / GN curved system stand / Présentoir GN courbé / Kurviger GN Ständer

REF	mm	H mm	€	U
22159	580 x 525	325	38,40	1

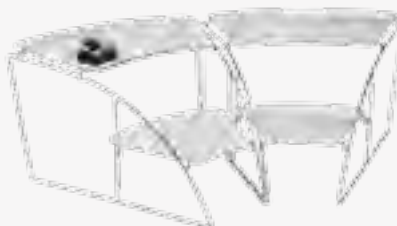

El precio no incluye cubetas / Price does not include containers / Les bacs ne sont pas inclus dans le PRIX / Behälter nicht im Preis inklusive

22154

Expositor buffet para cubetas GN 1/1 /
1/1 Gastronorm buffet displayer /
Présentoir buffet pour bacs GN 1/1 /
Buffetständer für GN 1/1 Behälter



REF	TIPO/TYPE	mm	H mm	€	U
22154	1/1	565 x 525	325	31,80	1

Cubetas no incluidas /
Containers not included /
Bacs non inclus /
Behälter nicht inklusive

22155

Expositor buffet para cubetas GN 1/2 /
1/2 Gastronorm buffet displayer /
Présentoir buffet pour bacs GN 1/2 /
Buffetständer für GN 1/2 Behälter



REF	TIPO/TYPE	mm	H mm	€	U
22155	1/2	360 x 525	325	30,05	1

Cubetas no incluidas /
Containers not included /
Bacs non inclus /
Behälter nicht inklusive

22156

Expositor buffet para cubetas GN 1/3 /
1/3 Gastronorm buffet displayer /
Présentoir buffet pour bacs GN 1/3 /
Buffetständer für GN 1/3 Behälter



REF	TIPO/TYPE	mm	H mm	€	U
22156	1/3	360 x 525	325	37,10	1

Cubetas no incluidas /
Containers not included /
Bacs non inclus /
Behälter nicht inklusive

22157

Expositor buffet para cubetas GN 1/6 /
1/6 Gastronorm buffet displayer /
Présentoir buffet pour bacs GN 1/6 /
Buffetständer für GN 1/6 Behälter



REF	TIPO/TYPE	mm	H mm	€	U
22157	1/6	360 x 525	325	36,70	1

Cubetas no incluidas /
Containers not included /
Bacs non inclus /
Behälter nicht inklusive

22123

Expositor 3 pisos con 3 bandejas /
3 Tier squared stand with 3 plates /
Présentoir 3 niveaux avec 3 Plateaux /
Buffetständer 3 Ebenen mit 3 Platten

NUEVO MODELO /
NEW MODEL /
NOUVEAU MODÈLE /
NEUES MODELL



REF	L mm	€	U
22123	770 x 460 x 830	133,85	1

22158

Expositor 4 vasijas /
4 Crocks system stand /
Présentoir 4 cruches /
Buffetständer 4 Gefässe



REF	mm	H mm	€	U
22158	580 x 528	325	33,55	1

Vasijas no incluidas. Ver 22160 pg 309 /
Crocks not included. View 22160 pg 309 /
Cruches pas incluses. Voir 22160 pg 309 /
Gefässe nicht inklusive. Siehe 22160 Seite 309

2222

Expositor bambú con 3 bols /
Bamboo displayer with 3 bowls /
Présentoir bambou avec 3 bols /
Buffetständer Bambus mit 3 Schalen



REF	mm	H mm	Lts	€	U
22220	290 x 110	35	0,20	31,75	6
22221	400 x 130	60	0,50	39,35	6
22222	495 x 160	85	1,10	64,00	6

MELAMINA / MELAMINE / MÉLAMINE / MELAMIN

2290 Plato / Dish / Assiette / Platte

REF	Ø mm	H mm	€	U
22901	195	28	6,50	12
22902	280	29	14,10	6

2297 Bol para noodles / Noodles bowl / Bol pour nouilles / Nudelschüssel

REF	Ø mm	H mm	€	U
22971	173	76	9,90	6
22972	250	87	17,60	6

2291 Bol / Bowl / Bol / Schüssel

REF	Ø mm	H mm	€	U
22911	101	40	3,35	24
22912	115	58	4,00	12

2296 Bol para salsas / Sauce bowl / Bol pour sauces / Schüssel für Sossen

REF	Ø mm	H mm	€	U
22960	115	55	3,65	20

2295 Plato para bol / Dish for bowl /
Assiette pour bol / Unterteller für Schüssel



REF	mm	H mm	€	U
22950	159 x 127	23	4,15	12

2294 Bandeja rectangular / rectangular Tray /
Plateau rectangulaire / Rechteckiges Tablett



REF	mm	H mm	€	U
22940	234 x 147	25	10,95	12

2292 Bandeja snacks o salsas /
Snacks or sauce tray /
Plateaux sauces /
Schale für Snacks oder Sossen



REF	mm	H mm	€	U
22920	190 x 80	30	5,85	12

2293 Bandeja snacks o salsas / Snacks or sauce tray /
Plateaux sauces / Schale für Snacks oder Sossen



REF	mm	H mm	€	U
22930	92 x 69	31	2,90	24

MELAMINA / MELAMINE / MÉLAMINE / MELAMIN

22270 Bandeja presentación oval pequeña /
Small oval plate /
Plateau présentation ovale petit /
Kleines ovales Buffertablett



REF	mm	H mm	€	U
22270	250 x 120	25	5,00	1

22271 Bandeja presentación cuadrada /
Square plate /
Plateau présentation carré /
Quadratisches Buffertablett



REF	mm	H mm	€	U
22271	365 x 365	44	20,65	1

22272 Bandeja presentación oval grande /
Large oval plate /
Plateau présentation ovale grand /
Grosses ovales Buffertablett



REF	mm	H mm	€	U
22272	530 x 265	45	31,95	1

22273 Bol ovalado pequeño /
Small oval bowl /
Bol ovale petit /
Kleine ovale Buffetschüssel



REF	mm	H mm	€	U
22273	250 x 120	75	7,00	1

22274 Bol cuadrado /
Square bowl /
Bol carré /
Quadratische Schüssel



REF	mm	H mm	€	U
22274	355 x 355	123	23,60	1

22275 Bol ovalado grande /
Large oval bowl /
Bol ovale grand /
Grosse ovale Schüssel



REF	mm	H mm	€	U
22275	530 x 270	107	39,25	1

22037 Fuente rectangular alta /
High oblong plate /
Plateau rectangulaire haut /
Hohe rechteckige Schale



REF	mm	H mm	€	U
22037	500 x 200	50	28,00	1

22038 Fuente rectangular alta /
High oblong plate /
Plateau rectangulaire haut /
Hohe rechteckige Schale



REF	mm	H mm	€	U
22038	350 x 250	50	25,15	1

2200 Fuente cuadrada / Squared tray /
Plateau carré / Quadratische Schale



REF	A mm	H mm	€	U
22001	335	55	22,50	3
22000	373	28	25,70	3

2201 Fuente rectangular / Oblong plate /
Plateau rectangulaire / Quadratische Schale



REF	A x B mm	H mm	€	U
22012	358 x 205	38	15,05	3
22013	443 x 221	44	18,50	3
22014	495 x 272	56	24,95	3
22015	557 x 322	52	27,70	3
22016	710 x 405	53	38,85	3

2209 Fuente rectangular honda / Classic deep dish /
Ravier carré / Tiefe quadratische Schale



REF	mm	H mm	€	U
22091	250 x 150	65	9,00	6
22092	305 x 220	25	11,85	6

22164 Fuente rectangular / Oblong serving dish /
Ravier / Quadratische Schale



REF	mm	H mm	€	U
22164	250 x 150	70	10,20	3
22165	350 x 250	70	21,30	3
22166	450 x 300	70	27,50	2



22090 Plato redondo de presentación /
Round plate presentation /
Plateau rond présentation /
Runder Servierteller



REF	Ø mm	H mm	€	U
22090	310	20	13,10	4

2215 Bandeja gastronorm /
Gastronorm tray /
Plateau gastronorme /
Gastronormplatte



REF	mm	H mm	€	U
22150	530 x 325	20	19,65	3
22151	325 x 265	20	15,85	6

22002 Bandeja exhibición cuadrada /
Squared display plate /
Plateau carré présentation /
Quadratische Präsentationsplatte



REF	mm	H mm	€	U
220021	305	35	19,10	3
22002	355	40	21,95	3
220023	405	45	28,35	3

22003 Bandeja exhibición cuadrada /
Squared display plate /
Plateau carré présentation /
Quadratische Präsentationsplatte



REF	mm	H mm	€	U
220031	310	40	12,80	3
22003	350	40	23,20	3
220033	420	50	30,65	3

2208 Bandeja exhibición rectangular / Oblong display tray /
Plateau rectangulaire / Quadratische Präsentationsplatte



REF	mm	H mm	€	U
22085	390 x 150	15	5,25	6
22086	500 x 180	18	7,35	6

22500 Fuente oval / Oval serving dish / Plat ovale / Ovale Buffetschale



REF	mm	H mm	€	U
22500	265 x 162	40	6,90	1
22501	325 x 200	40	10,30	1
22502	435 x 265	40	16,95	1



22170 Bandeja forma hoja / Leaf plate / Plateau forme feuille / Schale Blattform



REF	mm	H mm	€	U
22170	505 x 240	70	23,60	3

22163 Fuente oval / Oval serving dish / Plat ovale / Ovale Buffetschale



REF	mm	H mm	€	U
22163	715 x 285	40	40,90	3

22103 Bandeja 5 compartimentos / 5-Compartment bowl / Bol 5 compartiments / Schale 5 Unterteilungen



REF	Ø mm	H mm	€	U
22103	380	65	25,80	3



IDEA!

Espacio central ideal para salsas y dippear.
Central space ideal for sauces and dips.
Espace central idéal pour sauces et tartiner.
Das perfekte Mittelstück für Sossen und Dips.

22177 Bandeja redonda / round plate /
Plateau rond / Runder Servierteller



REF	Ø mm	H mm	€	U
22177	350	35	21,70	3

22023 Fuente oval honda / Oval plate /
Plateau ovale / Ovale tiefe Buffetschale



REF	mm	H mm	€	U
22023	500 x 360	67	20,25	3

22022 Fuente redonda / Round bowl /
Bol rond / Runde Buffetschüssel



REF	Ø mm	H mm	€	U
22022	360	70	19,75	3

22019 Bol redondo / Round bowl /
Bol rond / Runde Schüssel



REF	Ø mm	H mm	€	U
22019	200	90	12,50	3
22020	280	125	23,40	3
22021	380	170	32,20	3

2210 Bol redondo / Round bowl /
Bol rond / Runde Schüssel



REF	Ø mm	H mm	€	U
22100	160	90	5,15	6
22101	260	100	12,20	6
22102	360	130	21,30	3

22004 Bol cuadrado / Deep squared bowl /
Bol carré / Quadratische Schüssel



REF	mm	H mm	€	U
22004	250 x 250	88	16,60	3
22005	375 x 375	90	29,95	3

MELAMINA / MELAMINE / MÉLAMINE / MELAMIN

222

Bol cuadrado hondo /
Deep squared bowl /
Bol carré /
Tiefe quadratische Schüssel



REF	mm	H mm	€	U
22211	70 x 70	42	2,35	24
22200	90 x 90	55	3,05	12
22201	130 x 130	70	5,75	6
22202	180 x 180	85	9,45	6
22203	240 x 240	100	14,50	3
22204	300 x 300	115	20,45	3

2220

Bol cuadrado hondo dos colores /
Two tones deep squared bowl /
Bol carré deux couleurs /
Zweifarbige tiefe quadratische
Schüssel

REF	mm	H mm	ROJO / RED / ROUGE / ROT	AZUL / BLUE / BLEU / BLAU	AMARILLO / YELLOW / JAUNE / GELB	VERDE / GREEN / VERT / GRÜN	NEGRO / BLACK / NOIR / SCHWARZ	€	U
22200	90 x 90	55	R	A	AM	V	N	3,70	12
22202	180 x 180	85	R	A	AM	V	N	11,35	6
22203	240 x 240	100	R	A	AM	V	N	17,30	3



REF + Código color
REF + Color code
REF + Code couleur
REF + Farbcode

2216

Bol cónico /
Conical bowl /
Bol conique /
Konische Schüssel



REF	Ø mm	H mm	€	U
22167	130	85	4,40	6
22168	160	108	8,90	6

2217

Bol torneado /
Spin round bowl /
Bol tourné /
Gedrehte Schüssel



REF	Ø mm	H mm	€	U
22171	205	95	10,10	3
22172	245	105	15,35	3
22173	280	120	23,60	3

22169 Bol oval / Oval bowl /
Bol ovale / Ovale Schüssel



REF	mm	H mm	€	U
22169	290 x 165	150	21,50	6

22174 Bol redondo inclinado / Slanted round bowl /
Bol rond incliné / Schräge runde Schale

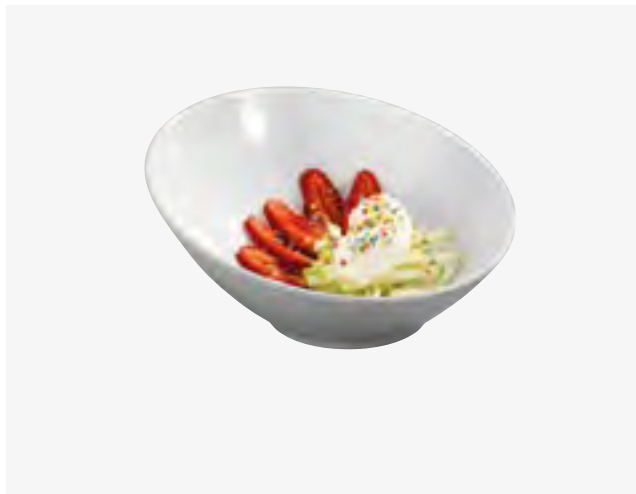

REF	mm	H mm	Lts	€	U
22174	212 x 208	104	0,60	13,20	6
22175	300 x 291	137	1,60	22,70	3
22176	360 x 349	163	2,85	32,50	3

22108 Platico cuadrado / Squared bowl /
Bol carré / Quadratisches Tellerchen



REF	mm	H mm	Lts	€	U
22108	100 x 100	33	0,10	1,55	24
22109	125 x 125	35	0,18	1,80	24

22099 Plato-bol / Bowl-plate /
Plat-bol / Teller-Schüssel



REF	Ø mm	H mm	€	U
22099	380	90	19,55	6

MELAMINA / MELAMINE / MÉLAMINE / MELAMIN

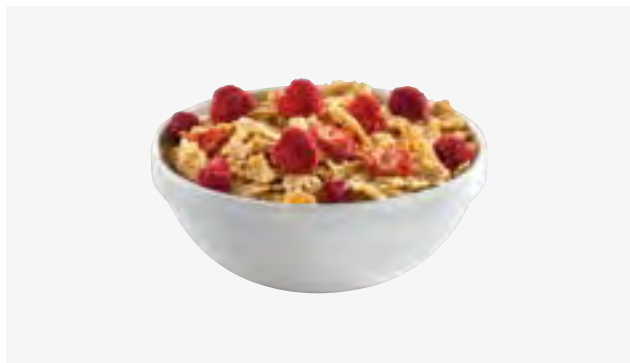
2225 Bol cereales encastrable / Stackable bowl /
Bol empilable / Stapelbare Müslischüssel

REF	Ø mm	H mm	€	U
22250	120	45	3,70	36
22251	140	55	5,45	36

22088 Pláttilo para huevo / Egg cup /
Coquetier / Eierbecher

REF	mm	H mm	€	U
22088	115 x 115	20	2,05	24

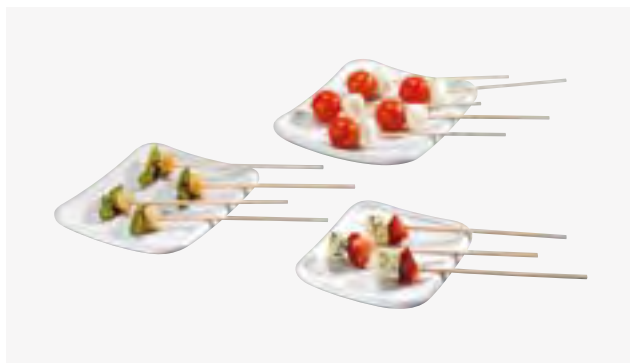
22104 Mini bandeja presentación / Mini square plate /
Plateau miniature / Mini Buffetttablett

REF	mm	H mm	€	U
22104	125 x 105	20	1,90	24
22105	140 x 130	20	2,45	24
22106	170 x 140	25	3,90	24

22107 Pláttilo concha / Shell saucer /
Soucoupe coquille / Muscheltellerchen

REF	mm	H mm	€	U
22107	155 x 115	20	2,15	24

867 Recipiente para salsas / Ramekin /
Ramequin / Sossengefäß

REF	ml	Ø mm	H mm	€	U
867.030	30	50	23	2,95	12
867.060	60	60	30	3,50	12
867.090	90	70	35	4,10	12
867.120	120	75	40	4,95	12

22890 Fuente rectangular / Small tray /
Ravier rectangulaire / Rechteckiges Buffetttablett

REF	mm	H mm	€	U
22890	130 x 90	20	3,80	1

Apilable/
Stackable/
Empilable/
Stapelbar



22178 Taza / Cup / Tasse / Tasse
Plato / Plate / Assiette / Unterteller



	REF	Size	Ø mm	H mm	Lts	€	U
TAZA / CUP /	22178	S	70	48	0,10	2,75	12
TASSE / TASSE	22180	L	98	65	0,25	5,35	12
PLATO / PLATE /	22179	S	103			1,55	12
ASSIETTE / UNTERTELLER	22181	L	144			2,85	12

Panera redonda y oval /
Round and oval bread basket /
22097 Corbeille à pain ronde et ovale /
Runder und ovaler Brotkorb



REF	mm	H mm	€	U
22097	Ø 240	70	7,05	6
22098	275 x 210	70	7,05	6

22033 Cuchara perforada / Slotted spoon /
Cuillère ajourée / Gelochter Löffel



REF	L mm	€	U
22033	300	2,25	24

22034 Cacillo / Soup ladle /
Louche / Schöpflöffel



REF	L mm	Lts	€	U
22034	270	0,08	2,25	24

22110 Cuchara degustación / Party spoon /
Cuillère amuse bouche / Verkostungslöffel



REF	mm	H mm	€	U
22110	145 x 45	50	0,70	60

22160 Vasija 1l / 1l crock /
Cruche 1l / Gefäß 1l



REF	Ø mm	H mm	€	U
22160	130	105	6,45	6

MELAMINA / MELAMINE / MÉLAMINE / MELAMIN

VAJILLA MELAMINA EXTRA FUERTE / HEAVY DUTY MELAMINE CROCKERY /
VAISSELLE MÉLAMINE EXTRA FORTE / EXTRA HARTES MELAMIN GESCHIRR



2211

Plato / Round dish /
Assiette plate / Teller



REF	Ø mm	H mm	€	U
22111	160	23	3,20	12
22112	200	23	4,95	12
22113	230	23	6,00	6
22114	265	23	7,05	6

22115

Plato sopa / Soup plate /
Assiette à soupe / Suppenteller



REF	Ø mm	H mm	€	U
22115	240	37	6,35	6

22116

Bol grande / Big salad bowl /
Saladier grand / Grosse Schüssel



REF	Ø mm	H mm	€	U
22116	190	50	4,95	6

22117

Bol pequeño / Small salad bowl /
Saladier petit / Kleine Schüssel



REF	Ø mm	H mm	€	U
22117	140	60	3,90	12

22182

Plato oval / Oval dish /
Assiette ovale / Ovaler Teller



REF	mm	H mm	€	U
22182	243 x 182	21	5,35	6
22183	305 x 232	25	7,80	6
22184	342 x 268	27	9,35	6

22118

Taza apilable / Stackable mug /
Tasse empilable / Stapelbare Tasse



REF	Ø mm	H mm	Lts	€	U
22118	75	100	0,30	4,20	6



22190 Bol grande / Big bowl /
Bol grand / Grosse Schüssel



REF	Ø mm	H mm	€	U
22190	193	68	11,15	6

22187 Bol / Bowl /
Bol / Schüssel



REF	Ø mm	H mm	€	U
22187	123	63	3,20	12
22188	162	78	5,35	12

22199 Palillos / chopsticks /
Baguettes / Esstäbchen



REF	L mm	€/pack	U/pack
22199	225	0,95	20

22195 Bandeja oval / Oval tray /
Plateau ovale / Ovales Tablett



REF	mm	H mm	€	U
22195	224 x 162	22	4,65	12
22196	253 x 184	20	6,00	12
22197	300 x 222	20	7,25	12

22191 Plato / Dish / Assiette / Teller



REF	Ø mm	H mm	€	U
22191	153	17	2,85	12
22192	175	20	3,60	12
22193	202	18	4,40	12
22194	255	23	6,65	12



CUBITERAS / WINE BUCKETS / SEAUX À CHAMPAGNE / CHAMPAGNERKÜHLER



311.F71 Cubo champán cónico con anillas /
Conical champagne bucket with rings /
Seau à champagne conique à anneaux /
Konischer Champagnerkühler mit Ringen

INOX - ST/STEEL
EDELSTAHL
18/10



REF	Ø cm	H cm	€	U
311.071	20	19,5	29,95	1

311.F72 Cubo champán cónico con pomos /
Conical champagne bucket with knobs /
Seau à champagne conique avec boutons /
Konischer Champagnerkühler mit Knäufen

INOX - ST/STEEL
EDELSTAHL
18/10

Pulido satinado
Satin polished
Polissage satiné
Satiniert poliert



REF	Ø cm	H cm	€	U
311.072	20	19,5	30,85	1

311.F2 Cubo champán con asas fijas /
Champagne bucket with fixed handles /
Seau à champagne à poignées fixes /
Champagnerkühler mit festen Griffen

INOX - ST/STEEL
EDELSTAHL
18/10



REF	Ø cm	H cm	€	U
311.002	18	19	24,65	1

311.F6 Cubo champán con anillas /
Champagne bucket with rings /
Seau à champagne à anneaux /
Champagnerkühler mit Ringen

INOX - ST/STEEL
EDELSTAHL
18/10



REF	Ø cm	H cm	€	U
311.006	18	19	26,55	1

SERVICIO DE MESA Y BUFFET /
TABLE AND BUFFET SERVICE /
SERVICE DE TABLE ET BUFFET

CUBITERAS / WINE BUCKETS / SEAUX À CHAMPAGNE / CHAMPAGNERKÜHLER

311.F1

Cubo champán con base y anillas /
 Champagne bucket with base and rings /
 Seau à champagne avec socle et anneaux /
 Champagnerkühler mit Fuss und Ringen

INOX - ST/STEEL
 EDELSTAHL
 18/10



REF	Ø cm	H cm	€	U
311.001	18	23	39,95	1

311.F3

Cubo champán con anillas /
 Champagne bucket with rings /
 Seau à champagne à anneaux /
 Champagnerkühler mit Ringen

INOX - ST/STEEL
 EDELSTAHL
 18/10



REF	Ø cm	H cm	€	U
311.003	18	20	31,90	1

378

Cubitera para botella pequeña /
 Champagne bucket "junior" /
 Seau à champagne pour demi-bouteille /
 Kühler für kleine Flaschen

INOX - ST/STEEL
 EDELSTAHL
 18/10



REF	Ø cm	H cm	€	U
378.000	14	16,5	23,85	1

311.F51

Cubo champán dos botellas con anillas /
 Champagne bucket two bottles with rings /
 Seau à champagne deux bouteilles à anneaux /
 Champagnerkühler zwei Flaschen mit Ringen

INOX - ST/STEEL
 EDELSTAHL
 18/10



REF	Ø cm	H cm	€	U
311.051	20	20	36,00	1

311.F52

Cubo champán dos botellas con pomos /
 Champagne bucket two bottles with knobs /
 Seau à champagne deux bouteilles avec boutons /
 Champagnerkühler zwei Flaschen mit Knäufen

INOX - ST/STEEL
 EDELSTAHL
 18/10



REF	Ø cm	H cm	€	U
311.052	20	20	34,45	1

326

Cubo champán dos botellas /
 Champagne bucket two bottles /
 Seau à champagne deux bouteilles /
 Champagnerkühler zwei Flaschen

INOX - ST/STEEL
 EDELSTAHL
 18/10



REF	Ø cm	H cm	€	U
326.000	25	22	36,00	1

CUBITERAS / WINE BUCKETS / SEAUX À CHAMPAGNE / CHAMPAGNERKÜHLER

9762 Cubo champán cónico con asas /
Conical champagne bucket with handles /
Seau à champagne conique avec poignées /
Konischer Champagnerkühler mit Griffen



REF	Ø cm	H cm	€	U
976.200	21	20	15,75	1

9763 Cubo champán cónico con anillas /
Conical champagne bucket with rings /
Seau à champagne conique à anneaux /
Konischer Champagnerkühler mit Ringen



REF	Ø cm	H cm	€	U
976.300	19	19	15,15	1

312 Cubo para hielo con disco separador /
Ice bucket with separative disk /
Seau à glaçons avec disque de séparation /
Eisbehälter mit Separationsscheibe

INOX - ST/STEEL
EDELSTAHL
18/10



REF	Ø cm	H cm	€	U
312.000	11	13	17,20	1

974 Enfriador isotérmico (doble pared) /
Double wall insulated cooler /
Refrâchisseur isotherme double paroi /
Doppelwändiger isothermischer Sektkühler



REF	Ø cm	H cm	€	U
974.000	10,5	20	19,30	1

3121 Cubitera isotérmica de mostrador /
Double wall ice pail /
Seau à glaçons isotherme /
Isothermischer Präsentationseisbehälter



REF	Ø cm	H cm	Lts	€	U
312.100	19,5	23	5,00	90,30	1

906 Cubo galvanizado /
Galvanized bucket /
Seau galvanisé /
Galvanisierter Eimer



REF	Ø cm	H cm	Lts	€	U
906.024	24	22	5,00	12,30	1

SERVICIO DE MESA Y BUFFET /
TABLE AND BUFFET SERVICE /
SERVICE DE TABLE ET BUFFET

CUBITERAS / WINE BUCKETS / SEAUX À CHAMPAGNE / CHAMPAGNERKÜHLER

988 Cubitera plástico / Plastic champagne bucket /
Seau à champagne en plastique / PlastikkühlerPlástico acrílico
Acrylic plastic
Plastique acrylique
Acrylplastik

REF	Ø cm	H cm	€	U
988.000	21	21,5	8,00	6

9881 Cubitera cónica acrílica /
Conical acrylic champagne bucket /
Seau à champagne conique acrylique /
Konischer Acrylkühler

REF	Ø cm	H cm	€	U
988.100	20	18,5	9,45	1

9882 Cubitera ovalada acrílica /
Oval acrylic champagne bucket /
Seau à champagne ovale acrylique /
Ovaler Acrylkühler* 3 Botellas / 3 Bottles /
3 Bouteilles / 3 Flaschen

REF	Ø cm	H cm	€	U
988.200	27 x 20	20	20,35	1
988.300*	35 x 26	27	34,75	1

989 Enfriador isotérmico acrílico (doble pared) /
Acrylic double wall insulated cooler /
Refrâchisseur isotherme acrylique /
Doppelwändiger isothermischer KühlerPlástico acrílico
Acrylic plastic
Plastique acrylique
Acrylplastik

REF	Ø cm	H cm	€	U
989.000	9,5	23	10,75	1

990 Manta enfriadora / Wine cooler /
Refrâchisseur / FlaschenkühlerReversible: burdeos y plata
Reversible: burgundy and silver
Réversible: bordeaux et argenté
Reversibel: Bordeauxrot und Silber

REF	cm	€	U
990.000	35 x 18	7,05	16

646 Soporte de mesa para cubo champán /
Champagne bucket holder /
Support de table pour seau à champagne /
Tischhalterung für Champagnerkühler

REF	Ø cm	L cm	H cm	€	U
646.000	18	52	17,0	30,45	1

Compatible con todos los modelos de cubos champán excepto con las ref. 326, 311.F51 y 311.F52
Suitable with all champagne bucket but ref. 326, 311.F51 y 311.F52
Adaptable pour tous les modèles de seaux à champagne sauf pour les réf. 326, 311.F51 et 311.F52
Geeignet für alle Modelle der Campagnerkühler ausser Artikel 326, 311.F51 und 311.F52

CUBITERAS / WINE BUCKETS / SEAUX À CHAMPAGNE / CHAMPAGNERKÜHLER

311.F4/F20/F35Pie con portacubos acero inox / St/Steel bucket-holder stand /
Pied porte-seau en inox / Kühlerhalter mit Fuss rostfreier Stahl

REF	Ø cm	H cm	€	U
311.004*	18	67,5	64,20	1
311.020**	22	69,0	69,60	1
311.335***	35	75,0	104,35	1

*
Compatible con los modelos
Suitable for references
Adaptable pour les références
Geeignet für Modelle
311.F2, 311.F3, 311.F6, 311.F8, 311.F71, 311.F72

**
Para cubitera 2 botellas / For 2 bottles bucket /
Pour seau à champagne deux bouteilles /
Für Kühler 2 Flaschen

Compatible con todos los modelos de cubos champán
Suitable with all champagne bucket models
Adaptable pour tous les modèles de seau à champagne
Geeignet für alle Modelle der Champagnerkühler

Pie cubitera para 3 botellas / 3 bottles stand-bucket /
Pied avec vasque pour 3 bouteilles / Standkühler für 3 Flaschen



311.004



311.020



311.335

327 Cubitera tipo ensaladera / Ice cube bowl /
Seau à glaçons type "saladier" / Kühler Typ Schale

REF	Ø cm	H cm	Lts	€	U
327.000	35	25	10,00	72,25	1

**310** Cubitera tipo ensaladera / Ice cube bowl /
Vasque / Kühler Typ Schale

REF	Ø cm	H cm	Lts	€	U
310.000	40	24,5	13,00	86,05	1



COMPLEMENTOS DE VINO / WINE COMPLEMENTS / ACCESSOIRES DU VIN / WEINZUBEHÖR

3994 Caja condimentos / Condiment holder /
Boîte à condiments / Gewürzkiste

REF	cm	H cm	COMPART.	€	U
399.400	30 x 14	8,5	4	24,15	1
399.500	38 x 14	8,5	5	27,30	1
399.600	45 x 14	8,5	6	29,35	1

Acero inoxidable /
Stainless steel /
Acier inoxydable /
Rostfreier Stahl

330 Coctelera / Shaker /
Shaker / Shaker

REF	H cm	Lts	€	U
330.035	18,0	0,35	13,65	1
330.050	20,5	0,50	16,50	1
330.070	23,5	0,70	22,40	1

3181 Colador gusanillo / Cocktail strainer /
Passoire à cocktail / Cocktailsieb

REF	Ø cm	L cm	€	U
318.100	7,6	11,7 x 15	6,25	1

319 Cuchara batidora / Cocktail spoon /
Cuillère à cocktail / Mixerlöffel

REF	L cm	€	U
319.000	26,5	3,90	1
319.100	27,9	2,95	12

399 Dosificador licor / Jigger /
Mesure à cocktail / Messbecher

REF	Ø cm	H cm	ml	€	U
399.000	A 3,7 B 4,1	A 2,8 B 5,7	25 50	10,65	1

388 Pinza hielo / Ice tong /
Pince à glaçons / Eiszange

REF	L cm	€	U
388.014	14	3,20	12
388.018	18,5	3,30	12

616 Exprime limones / Lemon squeezer /
Presse citron / Zitronenpresse

REF	L cm	€	U
616.000	17	6,45	1

COMPLEMENTOS DE VINO / WINE COMPLEMENTS / ACCESSOIRES DU VIN / WEINZUBEHÖR

984

Sacacorchos doble palanca /
Double-lever corkscrew /
Tire-bouchon double levier /
Doppelflügeliger Korkenzieher



REF	cm	€	U
984.100	17 x 6	6,45	12
984.150	21,5 x 7,5	17,45	3

9845

Sacacorchos de pared /
Wall-mounted corkscrew /
Tire-bouchon mur /
Korkenzieher Wandmontage



REF	cm	€	U
984.500	8 x 26 x 32	73,40	1

984

Sacacorchos "luxe" / Corkscrew "luxe" /
Tire bouchons "luxe" / Korkenzieher "luxe"



REF	€	U
984.000	27,40	1

985/986

Tapón botella / Bottle stopper /
Bouchon bouteille / Flaschenverschluss



REF	Ø cm	H cm	€	U
985.000	3	5,5	2,85	1
986.000	4	6,5	3,00	1
986.100	4	6,5	3,00	1

987

Cortacápsulas / Foil cutter /
Coupe capsules / Folienschneider



REF	COLOR / COLOUR / COULEUR / FARBE	L cm	H cm	€	U
987.100	■	6,5	2,85	3,00	1
987.200	■	6,5	2,85	3,00	1

983

Anillo anti-goteo / Ring stop drop /
Stop gouttes / Antitropfring



REF	Ø cm	H cm	€	U
983.000	4	2,0	1,90	1



885 Tetera / Tea pot / Théière / Teekanne



REF	Lts	€	U
885.025	0,25	19,45	1
885.040	0,40	23,40	1
885.060	0,60	27,90	1
885.120	1,20	44,15	1

Con filtro
With filter
Avec filtre
Mit Filter

886 Cafetera / Coffee pot / Cafetière / Kaffeekanne



REF	Lts	€	U
886.035	0,35	22,70	1
886.060	0,60	28,85	1
886.100	1,00	38,30	1
886.160	1,60	51,30	1

Con filtro
With filter
Avec filtre
Mit Filter

887 Lechera / Creamer / Crémère / Milchkanne



REF	Lts	€	U
887.015*	0,15	7,80	1
887.025*	0,25	13,20	1
887.035	0,35	14,90	1
887.060	0,60	18,20	1
887.100	1,00	30,55	1
887.160	1,60	43,55	1



* Diseño especial asas refs. 887.015 y 887.025 para facilitar el manejo
* Special handle design for refs. 887.015 and 887.025 for a better handling
* Spécial design pour anses ref. 887.015 et 887.025 pour améliorer la prise en main
* Spezielles Griffdesign für Art. 887.015 und 887.025 für die einfache Handhabung

888 Azucarero con tapa / sugar bowl with lid / Sucrier avec couvercle / Zuckerdose mit Deckel



REF	Lts	€	U
888.025	0,25	18,80	1
888.060	0,60	24,65	1

890 Tetera / Tea pot / Thière / Teekanne



REF	Lts	€	U
890.125	0,15	9,85	1
890.025	0,25	11,85	1
890.035	0,35	15,45	1
890.060	0,60	20,35	1
890.100	1,00	26,55	1

Con filtro
With filter
Avec filtre
Mit Filter

891 Cafetera / Coffee pot / Cafetière / Kaffeekanne



REF	Lts	€	U
891.035	0,35	14,20	1
891.060	0,60	19,55	1
891.100	1,00	25,40	1
891.150	1,50	34,00	1
891.200	2,00	43,00	1

Con filtro
With filter
Avec filtre
Mit Filter

892 Lechera / Creamer / Crémère / Milchkanne



REF	Lts	€	U
892.015	0,15	6,00	1
892.025	0,25	8,30	1
892.035	0,35	9,65	1
892.060	0,60	13,85	1
892.100	1,00	18,60	1
892.150	1,50	24,75	1
892.200	2,00	30,65	1

893 Azucarero con tapa / sugar bowl with lid / Sucrier avec couvercle / Zuckerdose mit Deckel



REF	Lts	€	U
893.025	0,25	8,70	1
893.035	0,35	9,85	1

880 Tetera / Tea pot / Théière / Teekanne



REF	Lts	€	U
880.020	0,20	29,55	1
880.035	0,35	29,65	1
880.050	0,50	35,15	1
880.100	1,00	45,70	1
880.175	1,75	57,95	1

881 Cafetera / Coffee pot / Cafetière / Kaffeekanne



REF	Lts	€	U
881.035	0,35	29,65	1
881.050	0,50	35,15	1
881.100	1,00	45,70	1
881.175	1,75	57,05	1

882 Lechera / Creamer / Crémère / Milchkanne



REF	Lts	€	U
882.015	0,15	9,65	1
882.035	0,35	16,35	1
882.050	0,50	19,55	1
882.100	1,00	31,05	1
882.175	1,75	47,10	1

883 Azucarero con tapa / Sugar bowl with lid / Sucrier avec couvercle / Zuckerdose mit Deckel



REF	Lts	€	U
883.035	0,35	12,80	1
883.050	0,50	15,25	1

TETERAS / TEA POTS / THÉIÈRES / TEEKANNE

23003/23004 Tetera "Japón" / "Japan" tea pot / Théière "Japon" / Teekanne "Japan"

REF	Lts	FILTRO / FILTER / FILTRE / FILTER Ø cm	€	U
23003	0,35	7,0	27,30	1
23004	0,80	8,0	39,15	1

Hierro fundido. Esmaltado interior. Con filtro de acero inoxidable.
Cast iron. Enameled inside. With St/Steel filter.
Fonte en fer. Intérieur émaillé. Avec filtre en acier inoxydable.
Gusseisen. Innen emailiert. Mit Edelstahlfilter.

23010 Tetera "Asia" / "Asia" tea pot / Théière "Asia" / Teekanne "Asia"

REF	Lts	FILTRO / FILTER / FILTRE / FILTER Ø cm	€	U
23010	0,40	6,3	30,15	1

Hierro fundido. Esmaltado interior. Con filtro de acero inoxidable.
Cast iron. Enameled inside. With St/Steel filter.
Fonte en fer. Intérieur émaillé. Avec filtre en acier inoxydable.
Gusseisen. Innen emailiert. Mit Edelstahlfilter.

896 Jarra para infusiones / Coffee maker - herbal tea jug / Pot à infusions / Kaffee- und Teemacher

NUEVO MODELO /
NEW MODEL /
NOUVEAU MODÈLE /
NEUES MODELL



Temp. max: 100 °C

REF	Lts	€	U
896.003	0,35	12,90	1
896.008	0,80	17,40	1

Para sacar el cristal es necesario desatornillar
To remove the glass it is necessary to unscrew
Pour enlever le verre il est nécessaire de dévisser
Das Glas ist nur durch Drehen zu entnehmen

23008/23009 Tetera "Nipón" / "Nipon" tea pot / Théière "Nipon" / Teekanne "Nipon"

REF	Lts	FILTRO / FILTER / FILTRE / FILTER Ø cm	€	U
23008	0,30	7,0	23,50	1
23009	0,60	8,0	31,50	1

Hierro fundido. Esmaltado interior. Con filtro de acero inoxidable.
Cast iron. Enameled inside. With St/Steel filter.
Fonte en fer. Intérieur émaillé. Avec filtre en acier inoxydable.
Gusseisen. Innen emailiert. Mit Edelstahlfilter.

23015 Tetera "Kenya" / "Kenya" tea pot / Théière "Kenya" / Teekanne "Kenya"

REF	Lts	FILTRO / FILTER / FILTRE / FILTER Ø cm	€	U
23015	0,40	7,0	29,15	1

Hierro fundido. Esmaltado interior. Con filtro de acero inoxidable.
Cast iron. Enameled inside. With St/Steel filter.
Fonte en fer. Intérieur émaillé. Avec filtre en acier inoxydable.
Gusseisen. Innen emailiert. Mit Edelstahlfilter.

8965 Colador bola infusiones / Tea infusion mesh / Boule à thé / Teesieb

REF	Ø cm	€	U
896.500	4,5	2,90	12

BANDEJA CAMARERO / ROUND SERVING TRAY / PLATEAU LIMONADIER / SERVICETABLETT

619 Bandeja camarero en acero inox / St/Steel round serving tray / Plateau limonadier en acier inox / Servicetablett aus rostfreiem Stahl



REF	Ø cm	€	U
619.001	30	14,80	1
619.002	35	15,65	1
619.000	40	20,55	1
619.003	45	23,85	1

Pulido brillante
Mirror polishing
Polissage brillant
Glänzend poliert

956 Bandeja de camarero antideslizante / Non slip serving tray / Plateau de service anti-dérapant / Servicetablett Antirutschbeschichtung



REF	COLOR / COLOUR / COULEUR / FARBE	Ø cm	€	U
956.035	Negro / Black / Noire / Schwarz	35	6,55	1
956.040	Negro / Black / Noire / Schwarz	40	8,00	1
956.135	Marrón / Brown / Marron / Braun	35	6,55	1
956.140	Marrón / Brown / Marron / Braun	40	8,00	1

Colores negro y marrón
Black and brown colour
Couleur noir et marron
Farben Schwarz und Braun

869 Botella bar / Bar keep / Bouteille de bar / Barflasche



REF	Lts	€	U
869.005	0,50	11,25	12
869.010	1,00	12,60	12
869.019	1,90	14,50	6
869.038	3,80	27,10	6

Incluye el juego completo de 1 cuello, 1 recipiente, 1 tapa y 6
surtidores de colores.
Includes 1 neck, 1 jar, 1 lid and 6 assorted colored spouts.
Inclus un jeu complet de 1 collier, 1 récipient, 1 couvercle et 6
bouchons doseurs en couleurs.
Inklusiv komplettes Set aus 1 Hals, 1 Behälter, 1 Deckel und 6
farbigen Ausgüssen

ALFOMBRAS CAUCHO / NATURAL RUBBER MATS / TAPIS EN CAOUTCHOUC / KAUTSCHUKMATTEN

26000 Alfombra / Mat / Tapis / Matte

REF	cm	€	U
26000	90 x 150 x 1,20	43,75	1

**26001** Alfombra / Mat / Tapis / Matte

REF	cm	€	U
26001	90 x 90 x 1,20	25,60	1

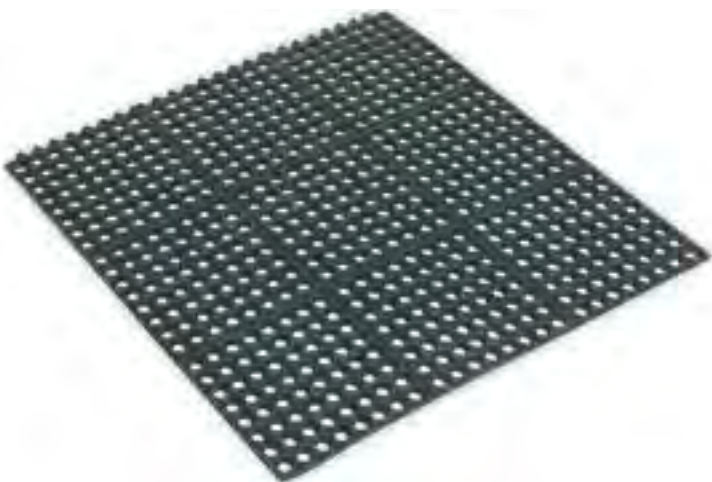

Estas alfombras se pueden conectar unas con otras formando mayores superficies.
You can connect these mats forming bigger surfaces.
Avec système de liaison pour composer une surface plus grande.
Für grössere Flächen kann man diese Matten mit anderen verbinden.

**26002** Alfombra / Mat / Tapis / Matte

REF	cm	€	U
26002	90 x 150 x 1,20	71,35	1



Resistente al aceite.
Oil resistant.
Résistant à l'huile.
Resistent gegen Öl.

ALFOMBRAS CAUCHO / NATURAL RUBBER MATS / TAPIS EN CAOUTCHOUC / KAUTSCHUKMATTEN

26003 Alfombra / Mat / Tapis / Matten

REF	cm	€	U
26003	90 x 90 x 1,20	40,60	1

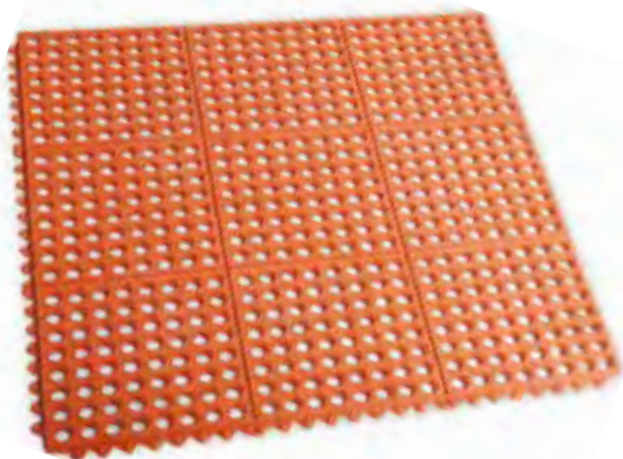

Estas alfombras se pueden conectar unas con otras formando mayores superficies.
You can connect these mats forming bigger surfaces.
Avec système de liaison pour composer une surface plus grande.
Für grössere Flächen kann man diese Matten mit anderen verbinden.

Resistente al aceite.
Oil resistant.
Résistant à l'huile.
Resistent gegen Öl.

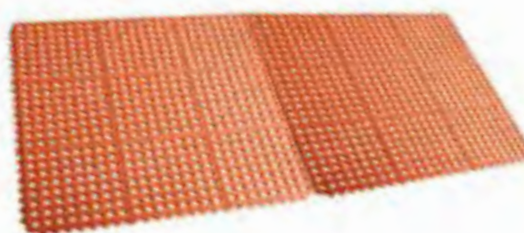

ALFOMBRAS DE PVC PARA ESCURRIDO DE COPAS / PVC BAR MAT / TAPIS PVC ÉGOUTTOIR POUR VERRES / PVC THEKENMATTEN - F31

26100 Alfombra de bar para escurrido de copas / Bar mat / Tapis égouttoir pour verres / Thekenabtropfmatten

REF	cm	€	U
26100	30 x 30 x 1,20	7,80	1



Se pueden conectar unas con otras formando mayores superficies.
They can be connected with each other forming bigger surfaces.
Avec un système de liaison pour composer une surface plus grande.
Für grössere Flächen kann man diese Matten mit anderen verbinden.





ESPAÑOL

MANTELES INDIVIDUALES FABRICADOS EN PVC + POLIESTER. PARA SU LIMPIEZA SE ACONSEJA USAR UNA ESPONJA O TRAPO HÚMEDO.

ENGLISH

PLACE MATS MADE OF PVC + POLYESTER. TO CLEAN PLEASE USE A DAMP SPONGE OR CLOTH

FRANCAIS

SETS DE TABLE FABRIQUÉS EN PVC + POLYESTER. POUR LE NETTOYAGE NOUS RECOMMANDONS L'UTILISATION D'UNE ÉPONGE OU UN CHIFFON HUMIDE.

DEUTSCH

INDIVIDUELLE PLATZMATTEN HERGESTELLT AUS PVC + POLYESTER. FÜR DIE EINFACHE REINIGUNG EMPFEHLEN WIR EINEN SCHWAMM ODER EIN FEUCHTES TUCH.

92605 Manteles individuales DECO / DECO place mats / Sets de table DECO / Individuelle Platzmatten DECO

REF	cm	€ Pack 6 u.	U
926.051	45 x 30	14,90	1
926.052	45 x 30	14,90	1
926.053	45 x 30	14,90	1



926.051



Líneas marrones-negras /
Brown&Black Lines /
Lignes marrons et noirs /
Braune und schwarze Linien

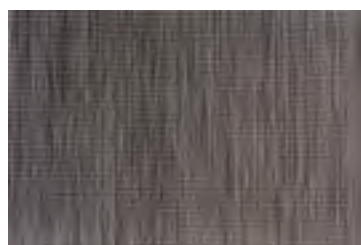

926.052



Marrón-negro /
Brown&Black /
Marron et noir /
Braun - Schwarz

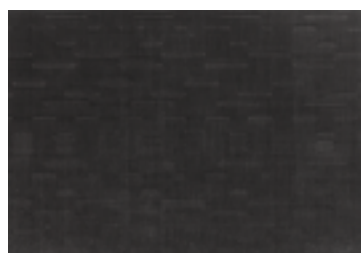

926.053



Negro /
Black /
Noir /
Schwarz

9260 Mantel individual trama fina / Place mat fine band /
Set de table maille fine / Platzmatte feinmaschig



REF	cm	€ Pack 6 u.	U
926.001	45 x 30	15,15	1
926.006	45 x 30	14,90	1
926.007	45 x 30	14,90	1
926.008	45 x 30	14,90	1
926.009	45 x 30	14,90	1
926.101	140 x 40	51,50	1

926.001 / 926.101



Beige /
Beige /
Beige /
Beige

926.006



Marrón /
Brown /
Marron /
Braun

926.007



Café /
Coffee /
Café /
Kaffee

926.008



Negro-Blanco /
Black&White /
Noir et blanc /
Schwarz-Weiss

926.009

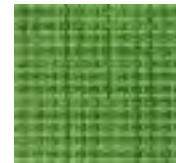

Verde /
Green /
Vert /
Grün

926 Mantel individual trama gruesa / Place mat wide band /
Set de table maille épaisse / Platzmatte grobmaschig



REF	cm	€ Pack 6 u.	U
926.002	45 x 30	15,15	1
926.003	45 x 30	15,15	1
926.004	45 x 30	15,15	1
926.005	45 x 30	15,15	1
926.010	45 x 30	14,90	1
926.011	45 x 30	14,90	1
926.012	45 x 30	14,90	1
926.102	140 x 40	51,50	1
926.103	140 x 40	51,50	1
926.104	140 x 40	51,50	1
926.105	140 x 40	51,50	1

926.002 / 926.102



Naranja /
Orange /
Orange /
Orange

926.003 / 926.103

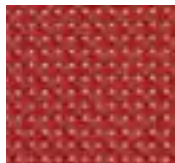

Burdeos /
Burgundy /
Bordeaux /
Bordeauxrot

926.004 / 926.104

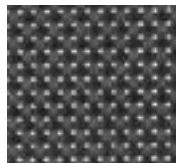

Negro /
Black /
Noir /
Schwarz

926.005 / 926.105

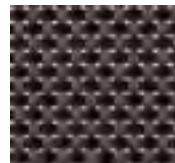

Marrón-Negro /
Brown&Black /
Marron et Noir /
Braun-Schwarz

926.010

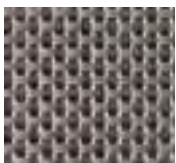

Marrón-Plata /
Brown&Silver /
Marron et Argent /
Braun versilbert

926.011



Marrón-dorado /
Brown&Gold /
Marron et Doré /
Braun-vergoldet

926.012

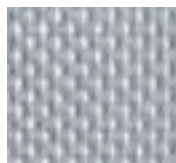

Plateado /
Silver /
Argent /
Versilbert

EXCLUSIVE

..... ESPAÑOL

GAMA DE MINIATURAS EN ACERO INOXIDABLE PARA UNA PRESENTACIÓN EXCLUSIVA Y ELEGANTE.
SE PUEDEN LAVAR EN EL LAVAVAJILLAS.

..... ENGLISH

RANGE ON MINIATURES MADE OF ST/STEEL FOR A NICE AND EXCLUSIVE PRESENTATION. DISHWASHER SAVE.

..... FRANÇAIS

GAMME DE MINIATURES EN ACIER INOXYDABLE POUR UNA PRÉSENTATION EXCLUSIVE ET ELEGANTE.
APTE POUR LAVE-VAISSELLE

..... DEUTSCH

MODELLREIHE VON MINIATUREN AUS ROSTFREIEM STAHL FÜR EINE EXCLUSIVE UND ELEGANTE PRÄSENTATION.
SPÜLMASCHINENGEEIGNET.

MINIATURAS INOX / ST/STEEL MINIATURES / MINIATURES INOX / EDELSTAHL MINIATUREN

2470 Mini cacerola alta con tapa /
Mini high round casserole with lid /
Mini cocotte haute avec couvercle /
Minikasserolle hoch mit Deckel

INOX - ST/STEEL
EDELSTAHL
18/10



REF	Ø cm	H cm	Lts	€	U
24701	8	4,8	0,20	20,80	1
24702	10	6,0	0,45	23,40	1
24703	12	7,2	0,80	25,70	1

2460 Mini cacerola con tapa /
Mini round casserole with lid /
Mini cocotte avec couvercle /
Minikasserolle mit Deckel

INOX - ST/STEEL
EDELSTAHL
18/10



REF	Ø cm	H cm	Lts	€	U
24600	8	3,2	0,15	20,90	1
24601	10	4,0	0,30	22,50	1
24602	12	4,8	0,55	23,70	1

2480 Mini cazo recto / Mini deep saucepan /
Mini casserole haute / Gerade Minisossenpfanne

INOX - ST/STEEL
EDELSTAHL
18/10



REF	Ø cm	L cm	H cm	Lts	€	U
24801	8	15,2	4,8	0,20	17,10	1
24802	10	20,0	6,0	0,45	18,75	1

2490 Mini cazo / Mini saucepan /
Mini casserole / Minisossenpfanne

INOX - ST/STEEL
EDELSTAHL
18/10



REF	Ø cm	L cm	H cm	Lts	€	U
24901	8	15,2	3,2	0,15	16,75	1
24902	10	20,0	4,0	0,30	18,00	1

2450 Mini sautex / Mini sauté pan /
Mini sauteuse / Minisauteuse

INOX - ST/STEEL
EDELSTAHL
18/10



REF	Ø cm	L cm	H cm	Lts	€	U
24500	8	15,2	1,6	0,08	14,00	1
24501	10	20,0	2,0	0,15	15,25	1
24502	12	23,0	2,4	0,25	16,35	1

2440 Mini cubo / Mini bucket /
Mini seau / Minieimer

INOX - ST/STEEL
EDELSTAHL



REF	Ø cm	H cm	Lts	€	U
24407	7,5	6,5	0,15	2,75	6
24409	9,0	8,5	0,32	4,00	6

23800Mini cacerola con tapa / Mini round casserole with lid /
Mini cocotte avec couvercle / Minikasserolle mit Deckel23811
2380123812
2380223813
2380323814
2380423815
2380523816
23806**EXCLUSIVE**

Ref. 23810



Ref. 23800

REF	Ø cm	H cm	Lts		€	U
23800	10	6,5	0,25	●	9,95	1
23801	10	6,5	0,25	●	9,95	1
23802	10	6,5	0,25	●	9,95	1
23803	10	6,5	0,25	●	9,95	1
23804	10	6,5	0,25	●	9,95	1
23805	10	6,5	0,25	●	9,95	1
23806	10	6,5	0,25	○	9,95	1
23810	14	8,0	0,75	●	13,90	1
23811	14	8,0	0,75	●	13,90	1
23812	14	8,0	0,75	●	13,90	1
23813	14	8,0	0,75	●	13,90	1
23814	14	8,0	0,75	●	13,90	1
23815	14	8,0	0,75	●	13,90	1
23816	14	8,0	0,75	○	13,90	1

CONDICIONES DE TRABAJO: ENTRE -20°C Y +70°C.
WITHSTANDS TEMPERATURES: -20°C & +70°C.
TEMPÉRATURES ENTRE: -20°C ET +70°C.
ARBEITSTEMPERATUREN ZWISCHEN: -20°C UND +70°C.

**MINIATURAS ALUMINIO DE FUNDICIÓN / CAST ALUMINIUM MINIATURES /
MINIATURES EN FONTE D'ALUMINIUM / ALUMINIUMGUSS MINIATUREN**
1510 / 1410Mini cacerola sin tapa / Mini round casserole without lid /
Mini cocotte sans couvercle / Minikasserolle ohne Deckel

REF	Ø cm	H cm	Lts	€	U
151.012	12	8,5	0,75	28,40	1
151.014	14	8,5	1,00	34,75	1
141.016	16	5,0	0,80	32,90	1

Ref. 151.012
151.014

Fondo torneado
Ground base
Fond dressé
Gedrechselter Unterboden



Ref. 141.016



MINIATURAS HIERRO FUNDIDO / CAST IRON MINIATURES /
 MINIATURES FONTE ÉMAILLÉE / MINIATUREN GUSSEISEN

ESPAÑOL

 MINIATURAS EN HIERRO FUNDIDO Y ESMALTADO INTERIOR, PERFECTAS PARA SERVICIO INDIVIDUAL Y PRESENTACIÓN.

ENGLISH

 ENAMELLED CAST IRON MINIATURES PERFECT FOR INDIVIDUAL SERVICE AND PRESENTATIONS.

FRANÇAIS

 MINIATURES EN FONTE ÉMAILLÉE (À L'INTÉRIEUR) IDÉALES POUR LE SERVICE INDIVIDUEL ET LA PRÉSENTATION

DEUTSCH

 MINIATUREN AUS GUSSEISEN INNEN EMAILIERT EIGNEN SICH PERFEKT FÜR DEN INDIVIDUELLEN SERVICE UND PRÄSENTATION.

23500 Mini sartén / Mini fry pan /
 Mini poêle ronde / Minibratpfanne



REF	Ø cm	L cm	H cm	€	U
23500	10,5	16	2,6	5,35	1

23501 Mini sartén / Mini fry pan /
 Mini poêle ronde / Minibratpfanne



REF	Ø cm	L cm	H cm	€	U
23501	13,5	21	2,5	8,40	1

23502 Mini sartén alta / Mini deep fry pan /
 Mini poêle ronde haute / Hohe Minibratpfanne



REF	Ø cm	L cm	H cm	€	U
23502	14	23,5	3,8	12,70	1

23503 Mini sartén cuadrada / Mini squared fry pan /
 Mini poêle carrée / Quadratische Minibratpfanne



REF	cm	L cm	H cm	€	U
23503	13,6 x 13,6	23,3	3,6	13,75	1

MINIATURAS HIERRO FUNDIDO / CAST IRON MINIATURES /
MINIATURES FONTE ÉMAILLÉE / MINIATUREN GUSSEISEN

23504 Mini sartén rectangular /
Mini oblong fry pan /
Mini poêle rectangulaire /
Rechteckige Minibratpfanne



REF	cm	L cm	H cm	€	U
23504	12,7 x 10,5	18	2,5	7,70	1

23508 Cacerola oval / Oval casserole /
Casserole ovale / Ovale Kasserolle



REF	cm	H cm	Lts	€	U
23508	21,5 x 15,5	6,5	0,60	20,75	1

23505 Mini cacerola con tapa /
Mini round casserole with lid /
Mini cocotte avec couvercle /
Minikasserolle mit Deckel



REF	Ø cm	L cm	H cm	Lts	€	U
23505	10	13	7,5	0,20	16,70	1

23507 Cacerola alta con tapa /
High round casserole with lid /
Cocotte haute avec couvercle /
Hohe Kasserolle mit Deckel



REF	Ø cm	H cm	Lts	€	U
23507	14	9,5	0,70	25,50	1

23506 Mini fuente oval con tapa /
Mini oval pan with lid /
Mini plateau oval avec couvercle /
Mini Buffetschale mit Deckel



REF	cm	L cm	H cm	€	U
23506	12 x 8	15,5	5,0	9,55	1

23509 Mini fuente oval alta con tapa /
High mini oval pan with lid /
Mini plate oval haute avec couvercle /
Ovale hohe Minibuffetschale mit Deckel



REF	cm	H cm	Lts	€	U
23509	12,5 x 9,3	7,5	0,25	25,45	1



ESPAÑOL

PRESENTACIÓN NATURAL, ELEGANTE Y EXCLUSIVA DE PLATOS FRÍOS O CALIENTES.

ENGLISH

NATURAL, ELEGANT AND EXCLUSIVE PRESENTATION OF COLD OR HOT PLATES.

FRANÇAIS

PRÉSENTATION NATURELLE, ÉLÉGANTE ET EXCLUSIVE DE PLATS FROIDS OU CHAUDS.

DEUTSCH

NATURELLE, EXCLUSIVE UND ELEGANTE PRÄSENTATION VON KALTEN UND WARMEN SPEISEN.

CARAS NATURALES / NATURAL FACES /
FACES NATURELLES / NATURELLE SEITEN

ESPEJOR / THICKNESS /
EPAISSEUR / DICKE : 4-5 mm

PIES ESPUMADOS / FOAMED FEET /
PIEDS MOUSSE / SCHAUMSTOFFFÜSSE



28202 Pizarra presentación cuadrada /
Squared slate serving tray /
Ardoise presentation carrée /
Quadratische Schieferplatte



REF	cm	€	U
28202	20 x 20	3,50	24

28252 Pizarra presentación cuadrada /
Squared slate serving tray /
Ardoise presentation carrée /
Quadratische Schieferplatte



REF	cm	€	U
28252	25 x 25	5,55	16

28303 Pizarra presentación cuadrada /
Squared slate serving tray /
Ardoise presentation carrée /
Quadratische Schieferplatte



REF	cm	€	U
28303	30 x 30	7,50	12

28302 Pizarra presentación rectangular /
Oblong slate serving tray /
Ardoise presentation rectangulaire /
Rechteckige Schieferplatte



REF	cm	€	U
28302	30 x 20	5,40	16

28403 Pizarra presentación rectangular / Oblong slate serving tray /
Ardoise presentation rectangulaire / Rechteckige Schieferplatte



REF	cm	€	U
28403	40 x 30	9,80	10



349 Jarra termo luxe / Luxe insulated coffee pot /
Pichet isotherme luxe / Luxus Thermoskanne



REF	Lts	€	U
349.030	0,30	46,80	1
349.060	0,60	51,60	1
349.100	1,00	59,25	1

Interior en acero inoxidable
Inner side in St/Steel
Interieur en acier inoxydable
Innen aus rostfreiem Stahl

337 Jarra termo / Insulated coffee pot /
Pichet isotherme / Thermoskanne



REF	Lts	€	U
337.030	0,30	47,75	1
337.060	0,60	52,75	1
337.090	0,90	59,80	1
337.150	1,50	75,00	1
337.200	2,00	95,45	1

Interior en acero inoxidable
Inner side in St/Steel
Interieur en acier inoxydable
Innen aus rostfreiem Stahl

895 Servidor termo / Vacuum jug /
Verseuse thermo / Servierthermoskanne



REF	Lts	€	U
895.006	0,60	20,35	1
895.010	1,00	23,40	1
895.015	1,50	27,20	1
895.020	2,00	29,55	1

Interior en acero inoxidable
Inner side in St/Steel
Interieur en acier inoxydable
Innen aus rostfreiem Stahl

894 Termo con dosificador / Air pot /
Verseuse à pompe / Thermoskanne mit Spender



REF	Lts	€	U
894.003	3,00	55,50	1
894.004	4,00	62,20	1
894.005	5,00	67,95	1

Base rotativa
Rotative base
Fond rotatif
Drehbare Basis

JARRA / SERVER / PICHET / KARAFFE

335 Jarra bombada con retén / Server without lid /
Pichet bombé avec retenu / Thermoskanne mit Reserve

REF	Lts	€	U
335.002	1,80	30,85	1

6464 Jarra / server /
Pichet / Karaffe

TUBO PARA HIELO
TUBE FOR ICE
TUBE POUR LA GLACE
ROHR FÜR EIS

**IDEA!**

Ideal para zumos.
Ideal for juices.
Idéal pour les jus.
Ideal für Säfte.

REF	Lts	€	U
646.400	1,90	23,60	1

6441 Jarra de policarbonato / Polycarbonate server /
Pichet en polycarbonate / Karaffe aus Polycarbonat

REF	Lts	€	U
644.100	1,00	8,50	1
644.175	1,75	11,55	1

6442 Jarra / server /
Pichet / Karaffe**EXCLUSIVE**

Fabricada en SAN /
Made of SAN /
Fabriquée en SAN /
Hergestellt in SAN

Max. Temp.
80 °C

REF	Lts	€	U
644.200	1,00	7,05	1
644.240	1,40	7,95	1
644.275	1,75	9,20	1

646 Jarra policarbonato apilable sin tapa /
Stackable polycarbonate server without lid /
Pichet polycarbonate empilable sans couvercle /
Karaffe aus Polycarbonat ohne Deckel

CE

REF	COLOR / COLOUR / COULEUR / FARBE	Lts	€	U
646.100	Translucido / Translucide / Tranparent	1,00	8,10	1
646.103	Azul / Blue / Bleu / Blau	1,00	9,75	1
646.105	Verde / Green / Vert / Grün	1,00	9,75	1
646.200	Translucido / Translucide / Tranparent	2,00	13,55	1

6463 Tapa polipropileno para jarra apilable /
Polypropylene lid for stackable Server /
Couvercle polypropylène pour pichet empilable /
Polycarbonat Deckel für Karaffe

REF	COLOR / COLOUR / COULEUR / FARBE	Lts	€	U
646.300	Azul / Blue / Bleu / Blau	1,00	2,35	1
646.310	Gris / Grey / Gris / Grau	1,00	2,55	1
646.301	Azul / Blue / Bleu / Blau	2,00	2,65	1

625 Pala recogemigas / Table crumber /
Pelle ramasse-miettes / Krümmelschaufel

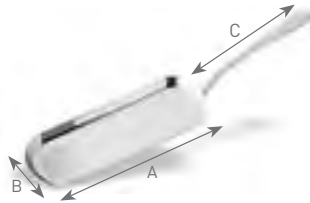

REF	A x B x C cm	€	U
625.000	18 x 7 x 12,5	7,25	1

630 Soporte para número "banquete" / Number card holder /
Support numéro "banquet" / Bankettnummerhalter



REF	H cm	€	U
630.010	10	9,25	1
630.020	20	10,30	1
630.030	30	11,75	1
630.040	40	14,30	1

632 Número de mesa / Table number /
Numéro de table / Tischnummer

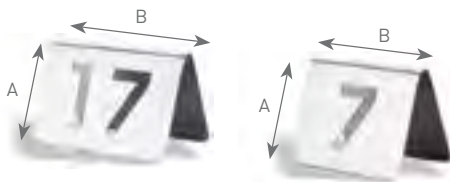



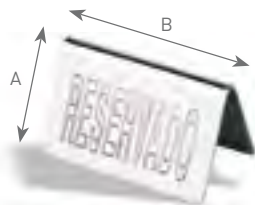

REF	A x B cm	€	U
632 + Número/Number	5,6 x 6,4*	2,20	1
	5,6 x 7,6**	2,20	1

N.1 - N.99
 * nº de 1 dígito ** nº de 2 dígitos
 * number with 1 digit ** number with 2 digits
 * numéro d'un seul chiffre ** numéro de 2 chiffres
 * Nummer mit einer Ziffer ** Nummer mit 2 Ziffern

633 Placa "Reservado" / "Reserved" table sign /
Plaque "reserve" / "Reserviert" Schild



REF	TEXTO / TEXT	A x B cm	€	U
 633.000	RESERVADO	5 x 10	3,90	1
 633.001	RESERVAT	5 x 10	3,90	1
 633.002	RESERVED	5 x 10	3,90	1
 633.003	RESERVE	5 x 10	3,90	1
 633.004	RESERVIERT	5 x 10	3,90	1

634 Placa "Prohibido fumar" / "Non-smoking" sign /
Plaque "Défense de fumer" / "Nichtraucher" Schild



REF	A x B cm	€	U
634.000	5,6 x 7,6	3,20	1

967 Molinillos pimienta y sal. Acrílico / Pepper mill-salt mill. Acrylic / Moulins à poivre et sel. Acrylique / Pfeffer- und Salzmühlen. Acryl.



	REF	TIPO / TYPE	H cm	€	U
A	967.001	Pimienta / Pepper / Poivre / Pfeffer	15,5	12,30	1
	967.002	Pimienta / Pepper / Poivre / Pfeffer	20,0	13,30	1
	967.003	Pimienta / Pepper / Poivre / Pfeffer	23,0	14,20	1
B	967.004	Sal / Salt / Sel / Salz	15,5	9,25	1
	967.005	Sal / Salt / Sel / Salz	20,0	10,30	1
	967.006	Sal / Salt / Sel / Salz	23,0	11,25	1

333 Salsera / Gravy boat / Saucière / Sossenkännchen



	REF	Lts	€	U
	333.010	0,10	5,25	1
	333.020	0,20	8,50	1
	333.035	0,35	9,75	1

623 Portasalados o portasalsas / Snack bowl set or sauce bowl set / Ensemble bols pour snacks ou sauces / Snack- oder Sossenständer



	REF	UNI.	Ø Bol	ml Bol	€	U
	623.002	2	9	200	31,05	1
	623.003	3	9	200	41,10	1

9691 Bandeja para mariscos / Sea food tray / Plateau fruits de mer / Meeresfrüchteplatte



	REF	Ø cm	H cm	€	U
	969.132	32	4,0	30,95	1
	969.136	36	4,0	33,65	1
	969.140	40	5,0	42,10	1

969 Soporte de mesa para bandeja marisco / Stand for sea food tray / Support pour plateau fruits de mer / Ständer für Meeresfrüchteplatte



	REF	Ø cm	H cm	€	U
	969.000	25 / 20	19,0	24,55	1

9681 Pincho / Skewer /
Brochette / Spiess



REF	L cm	€ (12un.)*	U
968.115	15	5,25	12
968.125	25	5,85	12
968.130	30	6,75	12
968.135	35	7,45	12

*Precio 12 unidades / Price 12 units / Prix 12 unités / Preis 12 Stück

968 Porta brochetas / Carry-skewers /
Porte-brochettes / Spiesshalter



REF	Ø cm	H cm	€	U
968.000	22	46,0	30,85	1

874 Pinchanotas / Bill spike /
Epingle porte-tickets / Bonspiess



REF	Ø cm	H cm	€	U
874.000	9	22	4,20	1

8621 Bandeja oval antideslizante / Non slip oval serving tray /
Plateau antidérapant forme ovale / Ovale Servicetablett Antirutschbeschichtung



REF	cm	€	U
862.100	68 x 56	35,25	1

Color negro
Black color
Couleur noir
Farbe Schwarz

863 Soporte para bandejas de gran tamaño / Large tray holder /
Support pour grands plateaux / Ständer für grosse Servicetabletts



REF	A x B x C cm	€	U
863.000	47 x 47 x 82	103,60	1

No incluye bandeja
Serving tray not included
Plateau non inclus
Servicetablett nicht inklusive

22030 Cenicero redondo con tapa. Color negro /
Windproof ashtray round with lid. Black /
Cendrier pour l'extérieur avec couvercle. Noir /
Runder Aschenbecher mit Deckel. Farbe Schwarz



REF	Ø cm	H cm	€	U
22030	14,5	6,0	6,25	1

Melamina / Melamine / Mélamine / Melamin

22031 Cenicero redondo. color negro /
Round dinner ashtray. Black /
Cendrier rond. Noir /
Runder Aschenbecher. Farbe Schwarz



REF	Ø cm	H cm	€	U
22031	10	5,0	0,95	1

Melamina / Melamine / Mélamine / Melamin

22185 Cenicero cónico melamina. Negro /
Conical melamine ashtray. Black /
Cendrier conique. Noir /
Konischer Aschenbecher. Schwarz



REF	Ø cm	H cm	€	U
22185	10	2,7	1,45	1

Melamina / Melamine / Mélamine / Melamin

638 Cenicero de agua / Water ashtray /
Cendrier à eau / Wasseraschenbecher

INOX - ST/STEEL
ROSTFREIER STAHL



REF	Ø cm	H cm	€	U
638.000	11	5,5	7,60	1

639 Cenicero hondo / Deep ashtray /
Cendrier profond / Tiefer Aschenbecher

INOX - ST/STEEL
ROSTFREIER STAHL



REF	cm	€	U
639.000	12,5 x 12,5 x 2,5	3,40	1

650 Papelera sobremesa acero inox /
St/Steel table-tidy /
Receptacle à déchets de table /
Tischabfalleimer rostfreier Stahl

INOX - ST/STEEL
ROSTFREIER STAHL



NUEVO MODELO /
NEW MODEL /
NOUVEAU MODÈLE /
NEUES MODELL

REF	Ø cm	H cm	€	U
650.000	12	21,0	14,50	1

357

Servilletero /
Napkin holder /
Porte-serviettes /
Serviettenspender

INOX - ST/STEEL
ROSTFREIER STAHL



REF	€	U
357.000	10,65	1

25000

Servilletero madera /
Wooden napkin holder /
Porte-serviettes en bois /
Holz Serviettenspender

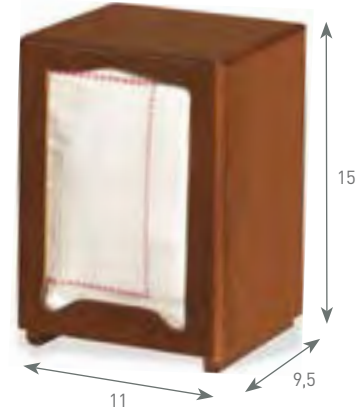

REF	€	U
25000	11,25	1

25002

Servilletero madera con portamenús /
Wooden napkin holder with menu holder /
Porte-serviettes en bois avec porte-menus /
Holz Serviettenspender mit Kartenhalter



REF	€	U
25002	11,55	1

25020

Servilletero con portamenús y palillero /
Napkin holder with menu and toothpick holder /
Porte-serviettes avec porte-cure-dents et porte-menus /
Holz Serviettenspender mit Zahnstocher- und Kartenhalter



REF	€	U
25020	12,80	1

SERVICIO DE MESA Y BUFFET /
TABLE AND BUFFET SERVICE /
SERVICE DE TABLE ET BUFFET

PORTAMENÚS / MENU HOLDER / PORTE-MENU / MENÜHALTER

ESPAÑOL

FABRICADO EN PVC.
BOLSILLOS EN CONTRATAPA
INTERIOR. PARA HOJAS DIN A4
Y DIN A5 PERSONALIZACIÓN
DISPONIBLE. ¡CONSÚLTENOS!

ENGLISH

MADE OF PVC. POCKETS ON
EACH BACK COVER. FOR DIN
A4 AND DIN A5 SHEETS
PERSONALISATION AVAILABLE.
ASK FOR IT!

FRANCAIS

FABRIQUÉ EN PVC. POCHE
DANS COUVERTURE INTÉRIEURE.
POUR FEUILLES DIN A4 ET DIN A5
PERSONALISATION DISPONIBLE.
CONSULTEZ-NOUS !

DEUTSCH

HERGESTELLT AUS PVC.
HÜLLEN IM INNEREN. FÜR
DIN A4 UND DIN A5 BLÄTTER
PERSONALISIERUNG MÖGLICH.
BITTE FRAGEN SIE UNS!

33 x 24 cm DIN-A4

Portamenús ELEGANCE / ELEGANCE menu holder /
Porte-Menus ELEGANCE / ELEGANZ Menümappe



Colores /
Colours /
Couleurs /
Farben



REF	COLOR / COLOUR / COULEUR / FARBE	cm	€	U
20041	Burdeos / Burgundy / Bordeaux / Bordeauxrot	33 x 24	11,75	1
20042	Negro / Black / Noir / Schwarz	33 x 24	11,75	1
20043	Marrón / Brown / Marron / Braun	33 x 24	11,75	1

20050

Porta blocs ELEGANCE / ELEGANCE Bill holder /
Porte-addition ELEGANCE / ELEGANCE Blockhalter



Color /
Colour /
Couleur /
Farbe

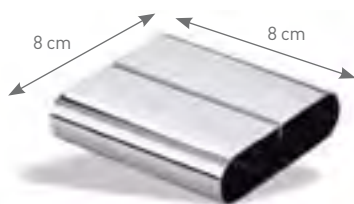

REF	COLOR / COLOUR / COULEUR / FARBE	cm	€	U
20050	Negro / Black / Noir / Schwarz	23 x 13	7,35	1

636 Portamenús / Menu holder /
Porte-menu de table / Menühalter

REF	H cm	€	U
636.000	2	4,40	1

637/6371 Platillo cambio / Bill holder /
Porte-addition / Wechselgeldtellerchen

Ref. 637

Ref. 6371

REF	cm	€	U
637.000	15,5 x 11	3,80	1
637.100	21,5 x 12,5	4,40	1

24,5 x 17 - 20 x 13,5 cm

Porta facturas / Bill Holder /
Porte-addition / Rechnungshalter



Color /
Colour /
Couleur /
Farbe

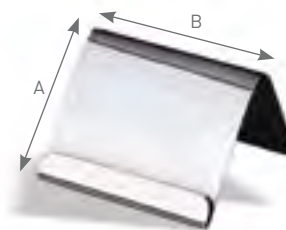

REF	COLOR / COLOUR / COULEUR / FARBE	A x B cm	€	U
20066	Negro / Black / Noir / Schwarz	24,5 x 17	21,40	1
20069	Negro / Black / Noir / Schwarz	20 x 13,5	19,75	1

635 Portatarjetas / Card holder /
Porte-cartes / Kartenhalter

REF	A x B cm	€	U
635.000	5,2 x 6,2	3,20	1



..... ESPAÑOL
 AMPLIA GAMA DE PRODUCTOS DE UN SÓLO USO, PARA UNA PRESENTACIÓN MODERNA, FABRICADOS EN POLIESTIRENO.
 ENGLISH
 WIDE RANGE OF DISPOSABLE PRODUCTS FOR A NICE & MODERN PRESENTATION. MADE OF POLYSTYRENE.
 FRANÇAIS
 BASTE GAMME DE PRODUITS JETABLES, POUR UNE PRÉSENTATION MODERNE. FABRIQUÉS EN POLYESTYRÈNE.
 DEUTSCH
 BREITE EINWEGPRODUKTSERIE FÜR EINE MODERNE PRÄSENTATION, HERGESTELLT AUS POLYSTYROEN.

100.100

Mini cacerola oval con tapa /
 Mini oval casserole with lid /
 Mini cocotte ovale avec couvercle /
 Minikasserolle oval mit Deckel



REF	cm	H cm	Lts	€/pack	U/pack
100.100	9,4 x 6,3	4,6	0,07	3,00	6

100.101

Conjunto bandeja con 12 mini cacerolas ovales /
 Kit tray with 12 mini oval casseroles /
 Ensemble plateau avec 12 cocottes ovales /
 Set Tablett mit 12 ovalen Minikasserollen



Compatible con art. 100.100 / Compatible with item 100.100 /
 Compatible avec art. 100.100 / Passend für Art.Nr. 100.100

REF	cm	H cm	€	U/pack
100.101	38 x 27,5	6,0	13,75	1

100.102

Mini bol ovalado con tapa y cucharilla /
 Mini oval bowl with lid and spoon /
 Mini bol ovale avec couvercle et cuillère /
 Minischale oval mit Deckel und Löffel



REF	cm	H cm	Lts	€/pack	U/pack
100.102	10 x 6	6,0	0,12	9,50	24

100.103

Conjunto bandeja con 12 mini bols ovalados y cucharillas /
 Kit tray with 12 mini oval bowl with spoon /
 Ensemble plateau avec 12 mini oval bols et cuillères /
 Set Tablett mit 12 Minischalen oval mit Deckel und Löffel



Compatible con art. 100.102 / Compatible with item 100.102 /
 Compatible avec art. 100.102 / Passend für Art.Nr. 100.102

REF	cm	H cm	€	U/pack
100.103	35,5 x 28,5	8,0	15,85	1

100.104

Mini cacerola redonda transparente con tapa /
 Mini clear round casserole with lid /
 Mini casserole ronde transparent avec couvercle /
 Minikasserolle rund transparent mit Deckel



REF	cm	H cm	Lts	€/pack	U/pack
100.104	Ø 6,5 x 7,6	2,4	0,05	3,95	12

100.106

Mini tarrina cuadrada con tapa /
 Mini squared terrine with lid /
 Mini terrine carrée avec couvercle /
 Quadratische Miniterrinen mit Deckel



REF	cm	H cm	Lts	€/pack	U/pack
100.106	6 x 6	7,0	0,10	8,90	24

100.108

Mini tarrina rectangular con tapa /
 Mini rectangular terrine with lid /
 Mini terrine rectangulaire avec couvercle /
 Minikasserolle transparent mit Deckel



REF	cm	H cm	Lts	€/pack	U/pack
100.108	9,5 x 5	4,7	0,08	5,80	24

100.105

Conjunto bandeja con 20 mini cacerolas redondas /
 Kit tray with 20 mini round casseroles /
 Ensemble plateau avec 20 mini casseroles rondes /
 Set Tablett 20 runde Minikasserollen



Compatible con art. 100.104 / Compatible with item 100.104 /
 Compatible avec art. 100.104 / Passend für Art.Nr. 100.104

REF	cm	H cm	€	U
100.105	38 x 27,5	4,0	14,90	1

100.107

Conjunto bandeja con 20 mini tarrinas cuadradas /
 Kit tray with 20 mini squared terrines /
 Ensemble plateau avec 20 mini terrines carrées /
 Set Tablett 20 Miniterrinen quadratisch



Compatible con art. 100.106 / Compatible with item 100.106 /
 Compatible avec art. 100.106 / Passend für Art.Nr. 100.106

REF	cm	H cm	€	U
100.107	38 x 27,5	7,5	17,10	1

100.109

Conjunto bandeja con 12 mini tarrinas rectangulares /
 Kit tray with 12 mini rectangular terrines /
 Ensemble plateau avec 12 mini terrines rectangulaires /
 Set Tablett 12 Miniterrinen rechteckig



Compatible con art. 100.108 / Compatible with item 100.108 /
 Compatible avec art. 100.108 / Passend für Art.Nr. 100.108

REF	cm	H cm	€	U
100.109	38 x 27,5	5,0	14,20	1

100.110

Platillo alto cuadrado /
High square tray /
Plateau haute carré /
Hohes quadratisches Tellerchen



REF	cm	H cm	Lts	€/pack	U/pack
100.110	5,8 x 5,8	1,7	0,01	6,15	50

100.111

Platillo cuadrado /
Square tray /
Plateau Carré /
Quadratisches Tellerchen



REF	cm	H cm	€/pack	U/pack
100.111	7,3 x 7,3	0,9	2,75	12

100.112

Mini cucharilla /
Mini spoon /
Mini cuillère /
Minilöffel



REF	cm	H cm	€/pack	U/pack
100.112	8,1 x 2,0	1,3	1,75	24

100.113

Cuchara degustación transparente /
Crystal tasting spoon /
Cuillère de dégustation transparente /
Transparenter Verkostungslöffel



REF	cm	H cm	€/pack	U/pack
100.113	12,8 x 3,9	3,6	2,70	24

100.114

Cuchara degustación redonda /
Round tasting spoon /
Cuillère de dégustation ronde /
Runder Verkostungslöffel



REF	cm	H cm	€/pack	U/pack
100.114	Ø 6,4 x 9,4	2,3	3,25	24

100.115

Molde mini-helado (2 unidades) /
Mini-Ice cream mould (2 units) /
Moule Mini-Glace (2 unités) /
Minieisform (2 Stück)



REF	cm	H cm	€	U
100.115	8,2 x 3,5	6,6	1,00	1

100.117

Platillo redondo presentación pizarra plástico /
Round plastic slate tray /
Présentoir ardois plastique ronde /
Rundes Buffettellerchen



REF	Ø cm	H cm	€/pack	U/pack
100.117	12,8	1,3	12,95	24
100.118	22,0	1,3	13,90	12

100.119

Platillo rectangular presentación pizarra plástico /
Rectangular plastic slate tray /
Présentoir ardois plastique rectangulaire /
Rechteckiges Buffettellerchen Schiefer



REF	cm	H cm	€/pack	U/pack
100.119	17,8 x 9	0,4	17,05	24

100.120 Vaso degustación transparente /
Tasting glass /
Verre dégustation /
Transparentes Verkostungsglas



REF	Ø cm	H cm	ml	€/pack	U/pack
100.120	4,7	10,5	140	4,70	12

100.121 Vaso degustación inclinado /
Sloping tasting glass /
Verre dégustation incliné /
Schräges Verkostungsglas



REF	Ø cm	H cm	ml	€/pack	U/pack
100.121	4,5	8,4	70	5,50	20

100.122 Vaso chupito degustación /
Tasting shot glass /
Petit verre dégustation /
Verkostungsschnapsglas



REF	Ø cm	H cm	ml	€/pack	U/pack
100.122	5,0	6,5	60	4,25	12

100.123 Vaso chupito degustación doble pared /
Double wall tasting shot glass /
Petit verre dégustation double mur /
Doppelwändiges Verkostungsschnapsglas



REF	Ø cm	H cm	ml	€/pack	U/pack
100.123	6,1	6,6	50	9,25	24

100.124 Taza / Cup /
Tasse / Tasse



REF	cm	H cm	ml	€/pack	U/pack
100.124	4,8 x 4,8	4,8	60	3,25	8
100.125	6,2 x 6,2	6,2	130	4,35	8
100.126	7,7 x 7,7	7,7	260	7,15	8

100.127 Mini bol / Mini bowl /
Mini bol / Minischale



REF	Ø cm	H cm	ml	€/pack	U/pack
100.127	12,0	5,0	180	5,60	12

100.129 Bandeja porta vasos 20 u. / 20 Glass holder tray /
Plateau porte verres 20 unités / Tablett für 20 Gläser

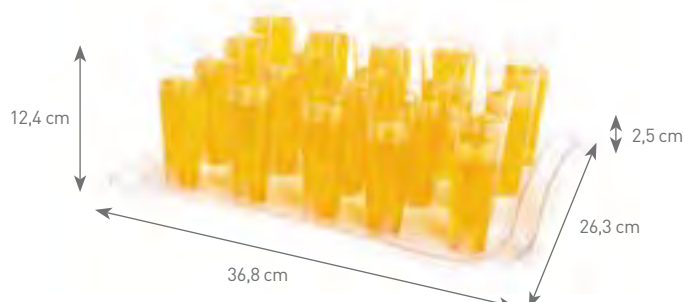

REF	Ø cm	H cm	ml	€/pack	U/pack
100.128	4,8	12,2	116	3,65	10
100.129	Bandeja / Tray / Plateau / Tablett			36,25	10

100.128
Vaso / Glass / Verre / Glas

Se venden por separado /
Sold separately /
Vendu séparément /
Seperater Verkauf

100.130 Copa Margarita monobloc /
One piece Margarita cup /
Verre monobloc Margarita /
Margaritaglas Monoblock



REF	Ø cm	H cm	ml	€/pack	U/pack
100.130	11,5	15,1	330	6,45	6

100.131 Copa Margarita 2 piezas /
Two pieces Margarita cup /
Verre deux pièces Margarita /
Margaritaglas 2 Teile



REF	Ø cm	H cm	ml	€/pack	U/pack
100.131	11,4	14,5	290	3,35	4

100.132 Copa cocktail /
Cocktail cup /
Verre à cocktail /
Cocktailglas



REF	Ø cm	H cm	ml	€/pack	U/pack
100.132	9,8	13,0	210	4,00	6

100.133 Copa Champán pequeña 2 piezas /
Two pieces small champagne cup /
Verre petit à champagne 2 pièces /
Kleines Champagnerglas 2 Teile



REF	Ø cm	H cm	ml	€/pack	U/pack
100.133	6,0	16,2	130	2,90	6

100.134 Copa Champán alta 2 piezas /
Two pieces high champagne cup /
Verre haut à champagne 2 pièces /
Hohes Champagnerglas 2 Teile



REF	Ø cm	H cm	ml	€/pack	U/pack
100.134	6,7	20,5	170	4,15	6

100.136 Peana presentación 10 conos champán /
Stand for 10 champagne cones /
Présentoir pour 10 cônes à champagne /
Buffetständer 10 Champagnerkegel



REF	Ø cm	H cm	ml	€/pack	U/pack
100.135	5	14,0	110	6,45	24
100.136	Peana / Stand / Présentoir / Buffetständer			6,45	1

**CARROS Y DISPENSADORES / TROLLEYS AND DISPENSERS /
 CHARIOTS ET DISTRIBUTEURS / SERVICEWAGEN UND SPENDER**

ESPAÑOL

CARRO SELF-SERVICE DE ACERO INOXIDABLE PARA BANDEJAS DE ANCHO 365 MM HASTA 420 MM. POSIBILIDAD DE INCORPORAR PLAFONES LATERALES COMPOSITE-ALUMINIO. PARA MÁS INFORMACIÓN VER EN PÁGINA 163

ENGLISH

SELF-SERVICE TROLLEY MADE OF ST/STEEL FOR TRAYS FROM 365 MM TO 420 MM WIDTH. AVAILABLE ALSO WITH TWO ALUMINIUM-COMPOSITE SIDE PANELS. FOR FURTHER INFORMATION REFER TO PAGE 163

FRANÇAIS

CHARIOT SELF-SERVICE EN ACIER INOXYDABLE POUR PLATEAUX DE 365 MM À 420 MM. DISPONIBLE AUSSI AVEC DEUX PANNEAUX LATÉRAUX EN COMPOSITE-ALUMINIUM. POUR PLUS DE RENSEIGNEMENTS VEUILLEZ CONSULTER PAGE 163

DEUTSCH

SELBSTBEDIENUNGSWAGEN AUS ROSTFREIEM STAHL FÜR TABLETTS DER BREITE 365 MM BIS 420 MM. DAS EINSETZEN VON SEITLICHEN ALUMINIUM-COMPOSIT WÄNDEN IST MÖGLICH. MEHR INFORMATIONEN AUF SEITE 163

**8074 Carro porta-cubiertos y bandejas / Trays and cutlery dispenser trolley /
 Chariot porte plateaux couverts / Besteck- und Tablettwagen**

REF	mm	€	U
80740	810 x 570 x 1065	435,55	1

No incluye cubetas GN 1/3 ni bandejas.
 Without 1/3 GN containers and trays.
 Bacs GN 1/3 et plateaux pas inclus.
 Behälter GN 1/3 und Tablett nicht inklusive.

Disponible también con ruedas poliamida. Consultar precio.
 Available also on polyamide castors. Please ask for price.
 Disponible aussi avec roulettes polyamide. Consulter prix.
 Auch lieferbar mit Polyamidrädern. Bitte fragen Sie nach dem Preis.

**8610 Bandeja fast-food fibra de vidrio / Fiberglass fast-food tray /
 Plateau fast food fibre de verre / Fiberglas fast-food Tablett**

REF	mm	€	U
861.045	455 x 355	16,05	12
861.053	530 x 325	16,80	12

Color gris.
 Grey color.
 Couleur gris.
 Farbe grau.

8070

Soporte para bandejas porta-cubiertos GN 1/1 /
Counter-top cutlery dispenser GN 1/1 /
Support porte-couverts GN 1/1 /
Ständer für Besteckkasten GN 1/1



No incluye bandeja portacubiertos / Cutterly bin not included
Bac ramasse-couverts non inclus / Besteckkasten nicht inklusive

REF	mm	€	U
80700	526 x 510 x 328	146,10	1

8071

Soporte doble para bandejas porta-cubiertos GN 1/1 /
Double counter-top cutlery dispenser GN 1/1 /
Support double porte-couverts GN 1/1 /
Doppelständer für Besteckkasten GN 1/1



No incluye bandeja portacubiertos / Cutterly bin not included
Bac ramasse-couverts non inclus / Besteckkasten nicht inklusive

REF	mm	€	U
80710	526 x 510 x 580	240,90	1

8072

Soporte para 4 cubetas GN 1/3 /
Counter-top dispenser for 4 GN containers 1/3 /
Support pour 4 bacs GN 1/3 /
Ständer für 4 Behälter GN 1/3



No incluyen cubetas GN / GN containers not included
Bacs GN non inclus / GN Behälter nicht inklusive

REF	mm	€	U
80720	738 x 310 x 430	125,55	1

8073

Soporte para 8 cubetas GN 1/3 /
Counter-top dispenser for 8 GN containers 1/3 /
Support pour 8 bacs GN 1/3 /
Ständer für 8 Behälter GN 1/3



No incluyen cubetas GN / GN containers not included
Bacs GN non inclus / GN Behälter nicht inklusive

REF	mm	€	U
80730	738 x 465 x 600	206,50	1

900

Bandeja porta-cubiertos gastronorm 1/1 /
1/1 gastronorm cutlery bin /
Bac ramasse-couverts gastronorme 1/1 /
Besteckkasten GN 1/1



Polipropileno alimentario / Food contact polypropylene
Polypropylène alimentaire / Polypropylen geeignet für den Lebensmittelkontakt.

REF	mm	€	U
900.000	530 x 325 x 100	11,25	1

340

Bandeja auto-servicio acero inox /
St/steel self-service tray /
Plateau self-service acier inox /
Selbstbedienungstablett rostfreier Stahl



6 Compartimentos / 6 Compartments.
6 Compartiments / 6 Unterteilungen

REF	mm	H mm	€	U
340.000	460 x 285	20	18,10	1

CARROS Y DISPENSADORES / TROLLEYS AND DISPENSERS /
CHARIOTS ET DISTRIBUTEURS / SERVICEWAGEN UND SPENDER**919** Bandeja isotérmica / Isothermal tray /
Plateau Isotherme / Isothermisches Tablett

REF	mm	€	U
919.000	530 x 370 x 110	171,55	1

Fabricada en polipropileno con interior aislante de poliuretano. Sin CFC.
Made of polypropylene with insulating polyurethane without CFC interior.
Fabriqué en polypropylène avec intérieur de polyuréthane sans CFC.
Hergestellt aus Polypropylen mit Innenisolierung aus Polyurethan.
Ohne CFC.

Adaptado para plato llano, hondo, bol, fuente rectangular en policarbonato, porcelana o melamina.
Suitable for flat plate, soup plate, bowl, salad bowl on polycarbonate, chinaware or melamine.
Apte pour assiettes plates, à soupe, bols, ravers, soit en polycarbonate, porcelaine ou melamine.
Geeignet für flache und tiefe Teller, Schüssel, rechteckige Schale aus Polycarbonat, Porzellan oder Melamin.

Complementos no incluidos / Complements not included.
Compléments non-inclus / Zubehör nicht inklusive

920 Platos policarbonato / Polycarbonate plates /
Assiettes en polycarbonate / Polycarbonat Teller

Ref. 920.001

REF	Tipo / Type	Ø mm	H mm	€	U
920.001	Llano / Flat / Plat / Flach	206	29	5,35	1
920.002	Hondo / Soup / À soupe / Tief	185	45	5,15	1
920.003	Desayuno / Breakfast / Petit déjeuner / Frühstück	175	25	3,80	1

Apto para lavavajillas y microondas /
Dishwasher and microwave safe
Utilisable au lave-vaisselle et micro-ondes /
Geeignet für Spülmaschinen und Mikrowellen

922 Fuente rectangular policarbonato /
Polycarbonate rectangular bowl /
Ravier rectangulaire en polycarbonate /
Rechteckige Schale aus Polycarbonat

REF	mm	H mm	Lts	€	U
922.000	95 x 138	45	0,25	5,15	1
922.100*	96 x 139	24		3,05	1

Apto para lavavajillas y microondas /
Dishwasher and microwave safe
Utilisable au lave-vaisselle et micro-ondes /
Geeignet für Spülmaschinen und Mikrowellen

*Tapa rígida /
*Rigid lid /
*Couvercle rigide /
*Harter Deckel

921 Bol doble pared policarbonato con tapa /
Double wall polycarbonate bowl with lid /
Bol polycarbonate double paroi avec couvercle /
Doppelwändige Schüssel aus Polycarbonat mit Deckel

REF	Ø mm	H mm	Lts	€	U
921.001	125	68	0,45	10,95	1

Apto para lavavajillas y microondas /
Dishwasher and microwave safe
Utilisable au lave-vaisselle et micro-ondes /
Geeignet für Spülmaschinen und Mikrowellen

923 Taza desayuno policarbonato /
Polycarbonate breakfast cup /
Tasse dessert polycarbonate /
Frühstückstasse aus Polycarbonat

REF	Ø mm	H mm	Lts	€	U
923.000	94	68	0,325	3,40	1
923.001*	100			0,95	1

Apto para lavavajillas y microondas /
Dishwasher and microwave safe
Utilisable au lave-vaisselle et micro-ondes /
Geeignet für Spülmaschinen und Mikrowellen

*Tapa /
*Lid /
*Couvercle /
*Deckel

924

Vaso policarbonato /
Polycarbonate glass /
Verre en polycarbonate /
Polycarbonat Becher



REF	Color / Couleur	Ø mm	H mm	Lts	€	U
924.001		70	102	0,25	1,70	1
924.002		70	70	0,17	1,70	1
924.002A		70	70	0,17	1,70	1
924.002R		70	70	0,17	1,70	1
924.002V		70	70	0,17	1,70	1



Apto para lavavajillas / Dishwasher safe
Utilisable au lave-vaisselle / Spülmaschinengeeignet

925

Carro transporte bandejas / Tray transport trolley /
Chariot transport plateaux / Transportwagen

REF	MEDIDA GUÍAS MM / SIZE OF RAILS MM / DIMENSIONS GLISSIÈRES MM / GRÖSSE DER EINSCHÜBE	Nº GUÍAS / NR. OF LEVELS / NUM. NIVEAUX / NR. EINSCHÜBE	MEDIDAS TOTALES MM / TOTAL SIZES MM / MESURES TOTALES MM / GESAMTGRÖSSE	DISTANCIA ENTRE GUÍAS / DISTANCE BETWEEN LEVELS / ESPACE ENTRE NIVEAUX / ABSTAND DER EINSCHÜBE	€	U
925.001	550 x 375	10	620 x 500 x 1520	120 mm	936,25	1
925.002	550 x 375	20	620 x 920 x 1520	120 mm	1.251,65	1

Carro fabricado en acero inoxidable y guías de plástico. Ideal para el transporte de bandejas de distintas medidas, gracias al diseño especial de sus guías. Ruedas giratorias insonoras de Ø 125 mm.

Trolley made of St/Steel and plastic rails. Perfect for many different size trays transport thanks to the special rail design. Soundproof revolving castors Ø 125 mm.

Chariot fabriqué en acier inoxydable et glissières en plastique. Idéal pour le transport des plateaux de différentes mesures, grâce au design spécial des glissières. Roulettes insonores de Ø 125 mm.

Wagen hergestellt aus rostfreiem Stahl mit Plastikeinschüben. Ideal für den Transport von Tablett verschieden Grössen, dank seinem speziellen Design der Einschübe. Geräuschlose drehbare Räder Ø 125 mm.



19100 / 19101 / 19113 Poste separación acero inoxidable / St/Steel barrier / Poteau acier inoxydable / Seperationspfosten rostfreier Stahl



REF	H cm	Kg	€	U
19100	95	10,5	73,50	1
19101	100	10,5	82,05	1
19113*	100	8,0	87,25	1

Ref. 19100 : Pulido brillante / Mirror Polished / Polissage brillant / Glänzend poliert

Ref. 19101 : Baño dorado / Golden coated / Doré / Goldbeschichtet

*Poste separación aspecto madera / Barrier. Wooden looking / Poteau aspect bois / Seperationspfosten Holzlook

Cordón no incluido
Belt not included
Cordon non inclus
Seil nicht inklusive

Ø 32 cm

19109 / 19110 Gancho soporte pared / Wall hook / Crochet mur / Wandhaken



REF	Color / Couleur Farbe	€	U
19109	Cromado / Chromium / Chromé / Chrom	14,20	1
19110	Dorado / Golden / Doré / Gold	15,45	1

Para ref. / For items / Pour réf. / Für Art. :
19100 / 19101 / 19113

19102 Poste separación con cinta roja retráctil / Barrier with red retractable belt system / Poteau dérouleur à sangle rouge / Seperationspfosten mit einziehbarem rotem Band

INOX - ST/STEEL
ROSTFREIER STAHL



REF	H cm	L cm	Kg	€	U
19102	96	210	8	124,50	1

Cabezal fijo.
Fix Head.
Tête fixe.
Fester Kopf.

19114 Poste con cinta retráctil. Brillante / Barrier with retractable belt. Mirror polished / Poteau dérouleur à sangle. Brillant / Pfosten mit einziehbarem rotem Band. Glänzend

INOX - ST/STEEL
ROSTFREIER STAHL



REF	Color / Couleur	H cm	L cm	Kg	€	U
19114-N	Negro / Black / Noir / Schwarz	94	200	9	80,15	1
19114-A	Azul / Blue / Bleu / Blau	94	200	9	80,15	1
19114-R	Rojo / Red / Rouge / Rot	94	200	9	80,15	1

Cabezal removable.
Detachable head.
Tête amovible.
Kopf abnehmbar.

19115 Recambio cabezal poste / Spare head for barrier /
Rechange de sangle / Ersatzkopf für Pfosten



REF	Color / Couleur	L cm	€	U
19115-N	Negro / Black / Noir / Schwarz	200	37,65	1
19115-A	Azul / Blue / Bleu / Blau	200	37,65	1
19115-R	Rojo / Red / Rouge / Rot	200	37,65	1

Para poste ref. 19114
For barrier ref. 19114
Pour poteau réf. 19114
Für Pfosten Art. 19114

19111 Cabezal pared cinta retráctil roja / Wall system barrier with red retractable belt /
Poteau dérouleur pour mur à sangle rouge / Kopf für rotes einziebares Band mit Wandbefestigung



REF	L cm	€	U
19111	210	42,70	1

19112 Soporte pared poste cinta retráctil / Wall support for wall barrier with retractable belt /
Support mur pour poteau dérouleur / Wandbefestigung für rotes einziebares Band



REF	€	U
19112	1,45	1

Para ref. / For ref / Pour ref / Für Art. :
19102 / 19114 / 19111

19116 Panel información / Information sign / Panneau information / Informationsschild



REF	cm	€	U
19116	21,8 x 32	42,40	1

Para ref. / For ref / Pour ref / Für Art. :
19114

19105 / 19107 / 19103 Cordón con ganchos cromados / Belt with chromium-plated ends /
Cordon à crochets chromés / Seil mit verchromten Haken



REF	Color / Couleur	L cm	€	U
19105	Burdeos / Burgundy / Bordeaux / Bordeauxrot	150	18,00	1
19107	Azul / Blue / Bleu / Blau	150	18,00	1
19103	Bronce / Plaited Bronze / Bronze / Bronze	150	36,00	1

19106 / 19108 / 19104 Cordón con ganchos dorados / Belt with golden ends /
Cordon à crochets dorés / Seil mit vergoldeten Haken

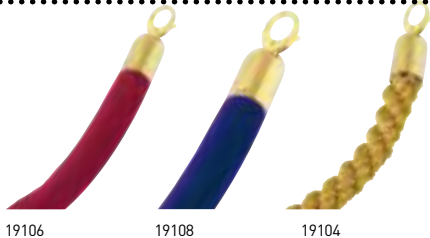

REF	Color / Couleur	L cm	€	U
19106	Burdeos / Burgundy / Bordeaux / Bordeauxrot	150	18,00	1
19108	Azul / Blue / Bleu / Blau	150	18,00	1
19104	Bronce / Plaited Bronze / Bronze / Bronze	150	38,65	1

ESPAÑOL

FABRICADAS CON UN MATERIAL PLÁSTICO ESPECIAL QUE NO SE RAYA. MARCOS DE MADERA RESISTENTES AL AGUA Y AL SOL. PIZARRAS ESPECIALMENTE DISEÑADAS PARA EL USO DE TIZAS O ROTULADORES CON BASE DE AGUA.

ENGLISH

PRODUCED FROM SPECIAL PLASTIC COMPLETELY ANTI-SCRATH MATERIAL. SOLID WOOD FRAME DOUBLE-LACQUERED. RAIN AND SUNPROOF. WRITING-SURFACES SPECIALLY DESIGNED FOR USING WATER BASED CHALKMARKERS.

FRANÇAIS

FABRIQUÉS AVEC UN MATÉRIEL PLASTIQUE SPÉCIAL ANTI-RAYURES. CADRES EN BOIS MASSIF. RÉSISTANTS À LA PLUIE ET AU SOLEIL. TABLEAUX SPÉCIALEMENT CONÇUS POUR L'UTILISATION DES CRAIES OU MARQUEURS AVEC BASE À EAU.

DEUTSCH

HERGESTELLT AUS EINEM SPEZIELLEM PLASTIK, WELCHES NICHT VERKRATZT. RAHMEN AUS HOLZ RESISTENT GEGEN WASSER UND SONNE. SPEZIELLES TAFELDESIGN FÜR DEN GEBRAUCH VON KREIDE UND FILZSTIFTEN.

21000 / 21001 Caballete-Duo



REF	A cm	B cm	€	U
21000	75	135	176,70	1
21001	55	85	116,00	1

21003 Caballete-Uno



REF	A cm	B cm	€	U
21003	55	85	62,55	1

2100 Universal



REF	A cm	B cm	€	U
21004	40	50	24,10	1
21005	50	60	27,25	1
21006	60	80	39,40	1
21007	70	90	49,00	1
21008	80	100	59,20	1

21013 / 21014 Curva



REF	A cm	B cm	€	U
21013	50	80	37,75	1
21014	60	105	60,00	1

2101 Lucky

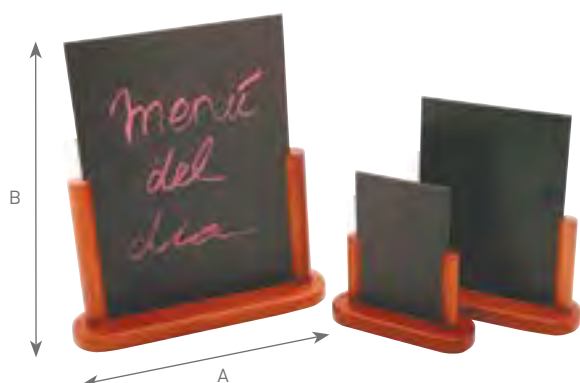

REF	A cm	B cm	€	U
21015	10	15	7,40	1
21016	15	21	8,90	1
21017	21	30	14,80	1

2102 Basic

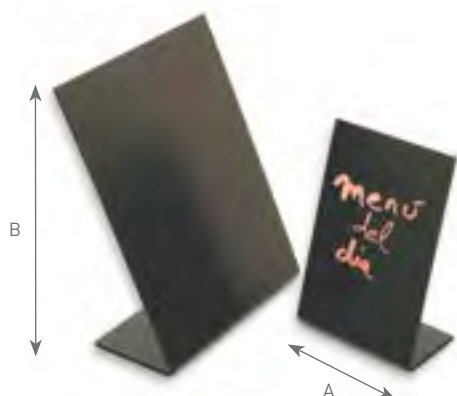

REF	A cm	B cm	€	U
21027	10	15	5,15	1
21028	15	23	8,80	1
21029	21	31	10,55	1

21020-26

Marcadores tiza fluorescentes, grueso 2-6 mm / Fluorescent Chalkmarkers widths, 2-6 mm
 Marqueurs fluorescents épaisseur, 2-6 mm / Fluoreszierende Kreidemarkers, Breite 2-6 mm



REF	COLOR / COLOUR / COULEUR / FARBE	€	U
21020	Blanco / White / Blanc / Weiss	5,15	1
21021	Rojo / Red / Rouge / Rot	5,25	1
21022	Azul / Blue / Bleu / Blau	5,25	1
21023	Amarillo / Yellow / Jaune / Gelb	5,25	1
21024	Verde / Green / Vert / Grün	5,25	1
21025	Naranja / Orange / Orange / Orange	5,25	1
21026	Rosa / Pink / Rose / Rosa	5,25	1

Resistentes a la lluvia. Fácil de borrar con un trapo húmedo /
 Rainproof. Easy to wipe off with damp cloth /
 Résistants à la pluie. S'efface facilement avec un chiffon humide /
 Resistent gegen Regen. Einfach zu löschen mit einem feuchten Tuch



PASTELERÍA /
PASTRY / PÂTISSERIE / PATISSERIE

- 6.1** UTENSILIOS DE PASTELERÍA /
PASTRY UTENSILS /
USTENSILES DE PÂTISSERIE /
PATISSERIEZUBEHÖR **364**
-
- 6.2** HELADERÍA /
ICE-CREAM UTENSILS /
UTENSILES POUR GLACE/
ZUBEHÖR FÜR EISCREME **376**
-
- 6.3** MOLDES ANTIADHERENTES /
NON-STICK MOULDS /
MOULES ANTI-ADHÉSIFS /
ANTIHAFT BACKFORMEN **378**
-
- 6.4** CORTAPASTAS /
PASTRY CUTTER /
DÉCOUPOIRS /
TEIGSCHNEIDER **384**
-
- 6.5** MOLDES ACERO INOXIDABLE /
ST/STEEL PASTRY MOULDS /
MOULES EN ACIER INOX /
BACKFORMEN ROSTFREIER STAHL **385**
-
- 6.6** MANGAS Y BOQUILLAS /
BAGS AND TUBES /
POCHES ET DOUILLES /
SPRITZBEUTEL UND TÜLLEN **389**
-
- 6.7** MOLDES SILICONA /
SILICONE MOULDS /
MOULES SILICONE /
SILIKONBACKFORMEN **395**
-
- 6.8** MOLDES FLEXIPAN /
FLEXIPAN MOULDS /
MOULES FLEXIPAN /
FLEXIPANBACKFORMEN **403**
-

PASTELERÍA

ESPAÑOL

PUJADAS OFRECE UN AMPLIO ABANICO DE MOLDES, AROS Y FORMAS DE EXTRAORDINARIA SOLIDEZ Y FABRICADOS EN DIVERSOS MATERIALES DE MÁXIMA CALIDAD. IDEALES PARA QUE EL PROFESIONAL PUEDA LLEVAR A CABO SUS MÁS SOFISTICADAS CREACIONES DE REPOSTERÍA.

TAMBIÉN SE PRESENTAN MULTITUD DE ARTÍCULOS COMPLEMENTARIOS PROPIOS DEL OFICIO DE LA PASTELERÍA PARA QUE EL PROFESIONAL REPOSTERO PUEDA REALIZAR SUS LABORES CREATIVAS EN LAS MEJORES CONDICIONES.

1. ANTIADHERENTE:

MOLDES CON CALIDAD PROFESIONAL. ANTIADHERENTE PTFE DE DOBLE CAPA QUE ASEGURA UNA MAYOR RESISTENCIA A LA ABRASIÓN, EXCELENTE ANTIADHERENCIA, MAYOR DURACIÓN DEL MOLDE Y GRAN FACILIDAD DE LIMPIEZA.

2. ACERO INOXIDABLE:

POR SUS CUALIDADES HIGIÉNICAS, EL ACERO INOXIDABLE HA IDO TOMANDO POSICIONES TAMBIÉN EN EL SECTOR DE LA PASTELERÍA. AQUÍ LE PRESENTAMOS UNA VARIADA GAMA DE AROS Y FORMAS.

3. MOLDES DE SILICONA:

FLEXIBLES Y ANTIADHERENTES. FÁCIL DE DESMOLDAR Y LIMPIAR. CUMPLEN LAS NORMAS DE USO ALIMENTARIO HACCP

4. MOLDES FLEXIPAN®

EL FLEXIPAN® ES UNA COMBINACIÓN DE FIBRAS DE VIDRIO Y SILICONA ADECUADAS PARA EL USO ALIMENTARIO.

EL FLEXIPAN® PERMITE REALIZAR QUALQUIER TIPO DE PREPARACIONES DULCES O SALADAS, TANTO EN COCCIÓN (+280 °C) O EN CONGELACIÓN (-40 °C).

PASTRY

ENGLISH

PUJADAS OFFERS AN EXTENSIVE ARRAY OF EXTREMELY RESISTANT MOULDS, RINGS AND FORMS IN VARIOUS MATERIALS OF THE HIGHEST QUALITY. IDEALLY SUITED FOR PROFESSIONALS DEVOTED TO THE CREATION OF THEIR MOST SOPHISTICATED WORKS OF ART.

A LARGE NUMBER OF ANCILLARY ITEMS ARE ALSO INTRODUCED TO ENABLE PROFESSIONAL PASTRY COOKS AND CONFECTIONERS TO CARRY OUT THEIR CREATIVE WORK IN THE BEST POSSIBLE CONDITIONS

1. NON-STICK MOULDS:

PROFESSIONAL QUALITY MOULDS. DOUBLE-PLY NON-STICK PTFE TO GUARANTEE THE BEST POSSIBLE RESISTANCE TO ABRASION, EXCELLENT NON-STICK CHARACTERISTICS. VERY EASY TO CLEAN AND LONG LASTING.

2. ST/STEEL MOULDS:

DUE TO THEIR HYGIENIC QUALITIES, ST/STEEL HAS ALSO BEEN INTRODUCED AND IT IS NOW REALLY VALUED IN THE PASTRY. THIS SERIES INTRODUCES A WIDE RANGE OF RINGS AND MOULDS.

3. SILICON MOULDS:

FLEXIBLE AND NON-STICK. EASY REMOVAL AND EASY TO CLEAN. SUITABLE FOR FOOD CONTACT AS PER INTERNATIONAL REGULATIONS HACCP.

4. FLEXIPAN® MOULDS

THE FLEXIPAN® IS A SILICONE AND FIBRE GLASS COMBINATION MOULD SUITABLE FOR THE FOOD CONTACT.

THE FLEXIPAN CAN BE USED TO BAKE (+280 °C) OR FREEZE (-40 °C) THE MOST SWEET AND SAVOURY PRODUCTS.



PÂTISSERIE

FRANÇAIS

PUJADAS PROPOSE UN LARGE ÉVENTAIL DE MOULES, CERCLES ET FORMES TRÈS ROBUSTES, FABRIQUÉS AVEC DIFFÉRENTS MATÉRIAUX D'UNE QUALITÉ MAXIMALE POUR PERMETTRE AU PROFESSIONNEL DE RÉALISER DES CRÉATIONS DE PÂTISSERIE LES PLUS SOPHISTIQUÉES. PUJADAS PROPOSE ÉGALEMENT DE NOMBREUX ARTICLES COMPLÉMENTAIRES PARTICULIERS À LA PÂTISSERIE POUR PERMETTRE AU PÂTISSIER DE MENER À TERME SES TÂCHES DE CRÉATION DANS LES MEILLEURES CONDITIONS POSSIBLES

1. MOULES ANTI-ADHÉSIFS:

MOULES DE QUALITÉ PROFESSIONNELLE. ANTI-ADHÉSIF PTFE DE DOUBLE COUCHE POUR ASSURER UNE MEILLEURE RÉSISTANCE À L'ABRASION. EXCELLENTE ANTI-ADHÉRENCE, LONGUE DURÉE DU MOULE ET NETTOYAGE TRÈS FACILE.

2. MOULES EN ACIER INOX:

POUR SES CARACTÉRISTIQUES HYGIÉNIQUES, L'ACIER INOXYDABLE EST DEvenu UN MATÉRIEL IMPORTANT EN PÂTISSERIE. NOUS VOUS PRÉSENTONS ICI UNE GAMME TRÈS COMPLÈTE DE MOULES ET FORMES.

3. MOULES EN SILICONE:

FLEXIBLES ET ANTI-ADHÉSIFS. RAPIDE ET FACILE DÉMOULAGE. MINIMUM D'ENTRETIEN. CES MOULES SONT CONFORMES AU CONTACT ALIMENTAIRE SELON LES NORMES INTERNATIONALES CERTIFIÉES HACCP.

4. MOULES FLEXIPAN®

LE FLEXIPAN® EST UNE COMBINAISON DE TISSUS DE VERRE ET SILICONES ADÉQUATS POUR L'UTILISATION ALIMENTAIRE.

LE FLEXIPAN® PERMET D'EFFECTUER TOUS TYPES DE PRÉPARATIONS SUCRÉES OU SALÉES, EN CUISSON (+ 280 °C) OU EN CONGÉLATION (-40 °C).

PATISserie

DEUTSCH

PUJADAS BIETET EINE GROSSE ANZAHL VON SCHABLONEN, RINGEN UND FORMEN VON AUSSERGEWÖHNLICHER FESTIGKEIT AUS VERSCHIEDENEN MATERIALIEN HÖCHSTER QUALITÄT AN. IDEAL FÜR JEDEN PROFI, DER DIE HÖCHSTENTWICKELTEN NACHSPEISEN KREIREN MÖCHTE.

AUCH PRÄSENTIEREN WIR IHNEN EINE VIELZAHL VON KONDITOREIEIGENEN ZUBEHÖRARTIKELN, MIT DENEN DER PROFESSIONELLE KONDITOR SEINE KREATIVSTEN ARBEITEN UNTER DEN BESTEN BEDINGUNGEN REALISIEREN KANN.

1. ANTIHAFTEND:

RAHMEN PROFESSIONELLER QUALITÄT. DOPPELTE ANTIHAFTBESCHICHTUNG PFTE, WELCHE DIE HÖCHSTE RESISTENZ GEGEN DEN VERSCHLEISS GARANTIERT, EXCELLENTE ANTIHAFTUNG, HÖCHSTE LEBENSDAUER DER RAHMEN UND EINFACHSTE REINIGUNG.

2. ROSTFREIER STAHL:

AUFGRUND SEINER HYGIENISCHEN EIGENSCHAFTEN HAT DER ROSTFREIE STAHL AUCH SEINEN PLATZ IN DEM SEKTOR DER KONDITOREI EINGENOMMEN. HIER PRÄSENTIEREN WIR IHNEN VERSCHIEDENE SERIEN VON RINGEN UND FORMEN.

3. SILIKONRAHMEN:

FLEXIBEL UND ANTIHAFTEND. EINFACH VOM RAHMEN ZU LÖSEN UND ZU REINIGEN. ERFÜLLEN DIE NORMEN FÜR DIE LEBENSMITTELVERARBEITUNG ENTSPRECHEND HACCP.

4. FORMEN FLEXIPAN®

FLEXIPAN® IST EINE KOMBINATION AUS FIBERGLAS UND SILIKON ANGEPASST AN DIE LEBENSMITTELVERARBEITUNG.

FLEXIPAN® ERLAUBT ES JEDWEDIGE ART DER VORBEREITUNG VON NACHSPEISEN ZU REALISIEREN, SOWOHL BACKEN (+280 °C) ALS AUCH EINFRIEREN (-40 °C).



304 Cazo bombeado / Conical saucepan / Casserole bombée / Kugelförmige Stielkasserole

INOX - ST/STEEL
EDELSTAHL
18/10



REF	Ø cm	H cm	Lts	€	U
304.016	16	7,5	1,00	21,85	1
304.018	18	8,0	1,70	23,75	1
304.020	20	10,0	2,50	26,15	1
304.022	22	11,5	3,70	28,60	1
304.024	24	12,0	4,50	32,70	1

3070 Caldero fondo plano / Boiler / Bassine à fond plat / Kessel ebener Boden

INOX - ST/STEEL
EDELSTAHL
18/10



REF	Ø cm	H cm	Lts	€	U
307.020	20	10,5	2,20	29,45	1
307.025	25	11,5	3,50	32,60	1
307.030	30	14,0	6,00	39,50	1
307.035	35	14,5	8,50	51,45	1
307.040	40	16,5	13,00	55,85	1
307.045	45	17,5	20,00	68,45	1
307.050	50	20,0	25,00	76,45	1
307.060	60	22,5	45,00	230,60	1
307.070	70	24,5	65,00	283,35	1

3072 Caldero con fondo difusor / boiler with sandwich bottom / Bassine à fond plat avec fond thermo-diffuseur / Kessel mit Sandwichboden

INOX - ST/STEEL
EDELSTAHL
18/10



REF	Ø cm	H cm	Lts	€	U
307.230	30	14,2	6,00	54,95	1
307.240	40	16,0	13,50	108,85	1



3071 Caldero fondo bombeado / Conical boiler / Bassine à fond bombé / Kessel kugelförmiger Boden

INOX - ST/STEEL
EDELSTAHL
18/10



REF	Ø cm	H cm	Lts	€	U
307.120	20	12,0	2,00	33,75	1
307.125	25	13,0	3,80	37,60	1
307.130	30	16,0	6,50	45,40	1
307.135	35	16,7	8,50	58,05	1
307.140	40	19,0	13,00	62,55	1
307.145	45	20,5	20,00	82,50	1
307.150	50	23,5	25,00	98,95	1

306 Caldero timbal / Mixing boiler / Bol mixeur / Rührschüssel

INOX - ST/STEEL
EDELSTAHL
18/10



REF	Ø cm	H cm	Lts	€	U
306.035	35	18,0	10,00	68,10	1

Una sola asa.
Only one handle.
Une seule anse.
Nur ein Griff.

356 Fuente honda cónica / Kitchen bowl / Bassine pâtissière / Rührschüssel

INOX - ST/STEEL
EDELSTAHL
18/10



REF	Ø cm	H cm	Lts	€	U
356.016	16	5,5	0,65	6,20	1
356.020	20	7,5	1,30	7,85	1
356.024	24	8,5	2,10	10,85	1
356.028	28	11,0	3,70	15,85	1
356.032	32	12,5	6,00	18,45	1

Medidas exteriores / Outer sizes /
Dimensions extérieures / Aussenmasse

107 Caldero fondo plano / Conical boiler / Bassine à fond plat / Kessel ebener Boden

ALUMINIO /
ALUMINIUM



REF	Ø cm	H cm	Lts	€	U
107.040	40	16,5	13,00	46,70	1
107.050	50	19,5	25,00	59,65	1
107.060	60	23,5	45,00	79,00	1

951 Librador de acero inox / St/steel scoop / Pelle à farine en acier inox / Mehlschaufel rostfreier Stahl



REF	L cm	Lts	€	U
951.010	10	0,10	13,35	5
951.015	15	0,40	16,25	5
951.019	19	1,00	17,75	5
951.024	24	1,70	21,20	5

953 Librador aluminio / Aluminium scoop / Pelle à farine aluminium / Mehlschaufel Aluminium



REF	L cm	Lts	€	U
953.001	11	0,15	3,40	12
953.002	15	0,35	4,65	12
953.003	18,5	0,71	8,55	12
953.004	21,5	1,10	11,15	12
953.005	25,5	1,71	15,45	12

952 Librador policarbonato / Polycarbonate scoop / Pelle à farine polycarbonate / Mehlschaufel Polycarbonat

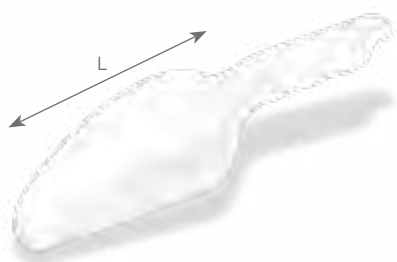

REF	L cm	Lts	€	U
952.001	13	0,17	2,80	12
952.002	15,5	0,35	3,50	12
952.003	17,5	0,71	4,95	12

316 Batidor (12 varillas) / Whisk (12 wires) / Fouet (12 fils) / Rührbesen (12 Drähte)

Grueso varilla / Wire thickness / Epaisseur des fils / Drahtdicke : 1,3 mm



REF	L cm	€	U
316.025	25	6,10	12
316.030	30	6,60	12
316.035	35	7,35	12
316.040	40	7,55	12
316.045	45	9,05	12
316.050	50	9,15	12

3161 Batidor (10 varillas) / Whisk (10 wires) / Fouet (10 fils) / Rührbesen (10 Drähte)

Grueso varilla / Wire thickness / Epaisseur des fils / Drahtdicke : 1,8 mm



REF	L cm	€	U
316.125	25	8,05	12
316.130	30	9,05	12
316.135	35	10,00	12
316.140	40	11,35	12
316.145	45	12,45	12
316.150	50	14,25	12

354 Batidor grueso (8 varillas) / Heavy whisk (8 wires) / Fouet épais (8 fils) / Rührbesen (8 Drähte)

Grueso varilla / Wire thickness / Epaisseur des fils / Drahtdicke : 2,4 mm

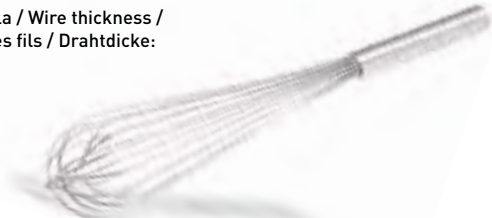

REF	L cm	€	U
354.025	25	6,80	12
354.030	30	6,90	12
354.035	35	7,15	12
354.040	40	8,25	12
354.045	45	8,55	12
354.050	50	9,80	12

959 Batidor mango abs antideslizante (8 varillas) / Whisk with anti-slip abs handle (8 wires) / Fouet avec poignée abs anti-crispation (8 fils) / Rührbesen Antirutschgriff ABS (7 Drähte)

Grueso varilla / Wire thickness / Epaisseur des fils / Drahtdicke : 2 mm



REF	L cm	€	U
959.025	25	7,65	12
959.030	30	7,75	12
959.035	35	8,85	12
959.040	40	10,75	12
959.045	45	12,75	12
959.050	50	14,35	12

393 Batidor gigante / Big whisk / Fouet à purée / Grosser Rührbesen

Grueso varilla / Wire thickness / Epaisseur des fils / Drahtdicke : 3 mm

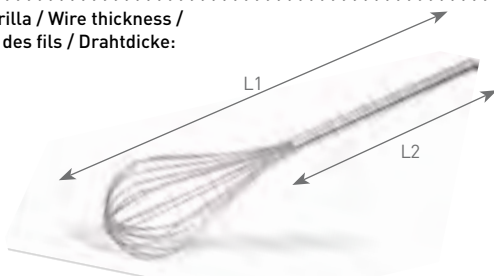

REF	L1 cm	L2 cm	€	U
393.080	80	45	41,55	1
393.100	100	65	51,80	1
393.125	125	90	55,55	1

3166 Batidor bolas / Ball whisk / Fouet à boules / Kugelrührbesen



REF	L cm	€	U
316.630	30	11,05	1
316.635	35	11,45	1
316.640	40	11,90	1

3165 Batidor rotatorio / Rotatory whisk / Fouet rotatif / Drehbarer Rührbesen



REF	L cm	€	U
316.530	30	10,00	12

398 Espátula de goma / Rubber spatula /
Spatule en caoutchouc / Gummispachtel



REF	L cm	€	U
398.024	23	3,30	1
398.035	33	6,40	1
398.042	41	8,05	1

Mango ergonómico. Goma aceptada para uso alimentario. Puede lavarse en el lavavajillas. Moldeado especial que previene la separación de la goma del mango. Anatomical handle. Suitable rubber for food contact. Safe dishwasher. Special mould that prevents the rubber to come off from the handle. Manche anatomique. Caoutchouc conforme au contact alimentaire. Utilisable au lave-vaisselle. Moulage spécial pour éviter la séparation de la gomme du manche. Ergonomischer Griff. Gummi geeignet für die Lebensmittelverarbeitung. Spülmaschinenfest. Spezieller Rahmen, der das Trennen von Gummi und Stiel vorsieht.

398290 Espátula estrecha goma /
Narrow rubber spatula /
Spatule étroite en caoutchouc /
Gerade Gummispachtel



Perfecta para vaciar tarros /
Perfect to empty small jars /
Parfait pour vider des petits pots /
Perfekt für das Leeren von
schmalen Behältern

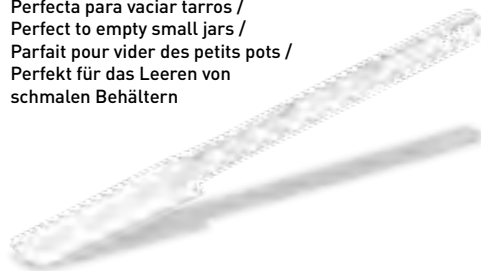

REF	PALA / PEEL / PELLE / SCHAUFEL cm	L cm	€	U
398.290	8,8 x 3,3	25,5	1,80	1

3981 Espátula silicona alta temperatura / High
heat silicone spatula. Bowl scraper /
Spatule silicone haute température /
Silikonspachtel hohe Temperaturen



REF	PALA / PEEL / PELLE / SCHAUFEL cm	L cm	€	U
398.125	9 x 6	25	8,95	1
398.135	11 x 7	35	11,55	1
398.140	11 x 7	40	11,75	1

Resistente hasta 260 °C / Heat resistance to 260 °C /
Résistante à 260 °C / Hitzeresistent bis 260 °C

3982 Cuchara silicona alta temperatura /
High heat silicone spoon /
Cuillère silicone haute température /
Silikonlöffel hohe Temperaturen



REF	PALA / PEEL / PELLE / SCHAUFEL cm	L cm	€	U
398.225	9 x 6	25	11,25	1
398.235	11 x 7	35	15,25	1
398.240	11 x 7	40	15,75	1

Resistente hasta 260 °C / Heat resistance to 260 °C /
Résistante à 260 °C / Hitzeresistent bis 260 °C

9602 Espátula multi-usos / Multi-purpose spatula / Spatule multi-usage / Spachtel Multigebrauch

-5 °C
 +70 °C



REF	L cm	€	U
960.225*	25	1,05	1
960.230*	30	1,35	1
960.235**	35	1,45	1

*Poliestireno / Polystyrene / Polystyrène / Polystyren
**Polietileno / Polyethylene / Polyéthylène / Polyethylen

806

Rodillo para perforar pasta /
Roller docker /
Rouleau pour piquer pâtes /
Stipprolle



REF	€	U
806.000	18,75	1

807

Rodillo para perforar pasta /
Roller docker /
Rouleau pour piquer pâtes /
Stipprolle



REF	€	U
807.000	13,55	1

839

Rodillo perforar pasta /
Roller docker /
Rouleau pour piquer pâtes /
Stipprolle



REF	€	U
839.000	9,50	1

840

Rodillo enrejado /
Lattice cutting roller /
Rouleau découpoir /
Gitterschneiderrolle



REF	€	U
840.000	14,45	1

841

Rodillo cortador /
Cutting roller /
Rouleau découpoir Demi-sphérique /
Schneiderrolle



REF	€	U
841.000	12,20	1

842

Cortapastas doble. Liso y rizado /
Double pastry cutter. Plain and serrated /
Roulette à pâtes double. Unie et cannelée /
Doppelter Teigschneider. Glatt und Gezackt



REF	€	U
842.000	12,20	1

843

Rodillo para cortar croissants /
Triangular croissant cutter /
Rouleau pour croissants /
Croissantschneiderrolle



REF	MEDIDAS DE CORTE (mm) / CUTTING SIZE (mm) / MESURES DE COUPE (mm) / SCHNEIDGRÖSSE (mm)	€	U
843.150	110 x 150	61,20	1
843.140	180 x 140	79,40	1
843.200	180 x 200	90,70	1
843.210	97 x 210	120,15	1

832

Cortapastas /
Pastry blender /
Découpoir /
Teigschneider



REF	€	U
832.000	4,85	1

805

Cortapastas extensible 7 ruedas /
Extendable cutter roller 7 castors /
Rouleau extensible 7 roulettes /
Ausziebarer Teigschneider 7 Rollen



REF	€	U
805.000	43,80	1

801

Rodillo acero inox /
St/Steel rolling pin /
Rouleau pâtissier acier inox /
Teigrolle rostfreier Stahl

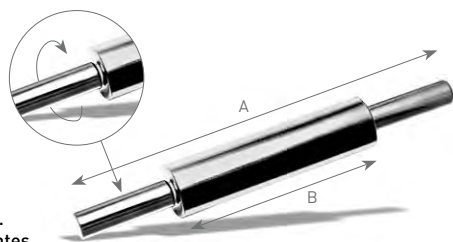

Asas giratorias.
Rolling handles.
Poignées roulantes.
Drehende Griffe.

REF	A cm	B cm	Ø cm	€	U
801.040	40	20	5,1	29,50	1
801.048	48	25	6,4	32,50	1

802

Rodillo polietileno con asas /
Polyethylene rolling pin with handles /
Rouleau en polyéthylène avec poignées /
Teigrolle Polyethylen mit Griffen

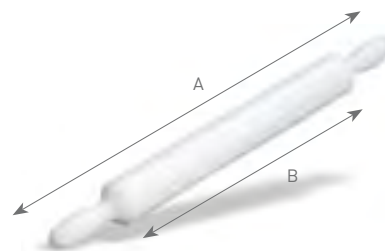

REF	A cm	B cm	Ø cm	€	U
802.000	60	40	4,8	55,75	1

803

Rodillo polietileno sin asas /
Polyethylene rolling Pin without handles /
Rouleau en polyéthylène Sans poignées /
Teigrolle Polyethylen ohne Griffen



REF	L cm	Ø cm	€	U
803.000	50	4,8	32,90	1

804

Rodillo de madera / Wooden rolling pin /
Rouleau en bois / Holzteigrolle

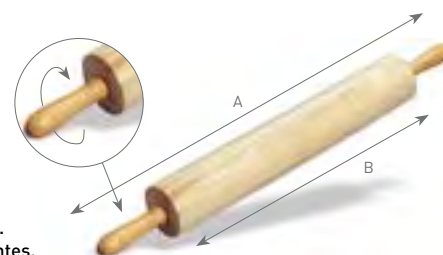

Asas giratorias.
Rolling handles.
Poignées roulantes.
Drehende Griffe.

REF	A cm	B cm	Ø cm	€	U
804.000	67,5	45,5	7,7	20,70	1

845

Pinel de polipropileno /
Polypropylene brush /
Pinceau en polypropylène /
Pinsel Polypropylen



REF	mm	€	U
845.040	40	7,15	1
845.050	50	9,45	1
845.060	60	9,80	1
845.075	75	12,95	1

8451

Cepillo plástico + cerdas nylon /
Plastic brush + nylon bristle /
Pinceau plastique + poils nylon /
Plastikbürste + Nylonborsten



REF	mm	€	U
845.138	38	4,20	1
845.155	55	5,40	1
845.110	100	8,90	1

8452

Cepillo cerdas nylon con soporte olla /
Nylon bristles brush with hook for pot /
Pinceau poils nylon avec support pot /
Bürste Nylonborsten mit Topfhalterung



REF	mm	€	U
845.275	75	9,25	1

836

Rasquetas de polipropileno /
Polypropylene scrapers /
Raclettes en polypropylène /
Schaber aus Polypropylen

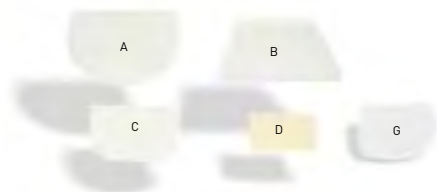

REF	mm	€	U
A 836.200	204 x 151	3,10	1
B 836.215	221 x 130	3,20	1
C 836.147	151 x 102	1,35	1
D 836.110	112 x 78	0,95	1
G 836.120	128 x 90	0,95	1

847

Marcador de tartas / Cake divider /
Séparateur de portions / Tortenschneider



REF	PORCIONES / PORTIONS / PORTIONEN	€	U
847.008	8	6,50	1
847.010	10	6,50	1
847.012	12	6,50	1
847.014	14	6,50	1

Polipropileno. Ø Total: 26,5 cm
Polypropylene.
Polypropylène.
Polypropylen.

8725

Rasqueta mango ABS / Scraper ABS handle /
Raclette manche ABS / Schaber ABS Griff



REF	cm	€	U
872.500	21 x 14,5	8,00	1

808

Peine decorador /
Decorating comb /
Peigne à decor /
Dekorationskamm



REF	cm	€	U
808.000	11 x 8	3,20	1

848

Marcador de tartas doble /
Double cake divider /
Séparateur de portions double /
Doppelter Tortenschneider



REF	PORCIONES / PORTIONS / PORTIONEN	€	U
848.008	8 / 12	7,25	1
848.014	14 / 16	7,25	1

Polipropileno. Ø Total: 26,5 cm
Polypropylene.
Polypropylène.
Polypropylen.

VER PRODUCTOS EN / SEE PRODUCTS ON /
VOIR PRODUITS EN / SIEHE PRODUKTE IN

UTENSILIOS / UTENSILS /
USTENSILES / ZUBEHÖR



P. 64



979 Soplete cocina / Pastry torch by gas / Torche à caraméliser / Küchengasbrenner

CE



Ref. 979.000

Llama super fuerte /
Super strong flame /
Flamme extra fort /
Super starke Flamme

REF	cm	€	U
979.100	10 x 13,6	19,30	1
979.200	13 x 17,5	29,40	1
979.000	16,5 x 21	50,40	1

Duración: 120 min.
Length: 120 min.
Durée: 120 min.
Dauer: 120 min.

IDEA!

Descongelación, esterilización, escultura de hielo,
crema brûlée, caramelización /
kitchen use, defrosting, sterilizing, ice sculpture,
crème brûlée, caramelization /
Décongélation, stérilisation, sculpture de glace,
crème brûlée, caramélisation /
Auftauen, Sterilisieren, Eisskulptur, Crème Brûlée,
Karamelisieren



Ref. 979.100

Llama normal /
Standar flame /
Flamme normal /
Normale Flamme



Ref. 979.200

Llama fuerte /
Strong flame /
Fort flamme /
Starke Flamme

991 Quemador eléctrico redondo / Round electric caramelizer / Fer à caraméliser électrique rond / Elektrischer runder Brenner

CE



REF	Ø cm	L cm	W	€	U
991.010	8	34	400	75,85	1

Tapa rectangular GN de policarbonato /
GN polycarbonate rectangular lid /
Couvercle rectangulaire GN en polycarbonate /
Rechteckiger GN Deckel Polycarbonat

834



REF	mm	H mm	€	U
834.000	530 x 325	100,0	67,95	1

9911 Quemador eléctrico rectangular / Rectangular electric caramelizer / Fer à caraméliser électrique rectangulaire / Rechteckiger elektrischer Brenner

CE



REF	cm	L cm	W	€	U
991.108	24 x 8	49,5	1200	124,35	1
991.112	24 x 12	49,5	2000	132,60	1

835

Campana GN de policarbonato /
GN polycarbonate dome lid /
Dôme de protection GN en polycarbonate /
GN Haube Polycarbonat



REF	mm	H mm	€	U
835.000	530 x 325	190,0	64,35	1

837 Expositor de tartas de aluminio / Aluminium cake stand /
Présentoir de tartes en aluminium / Tortenständer aus Aluminium



REF	Ø cm	€	U
837.003	20 / 26 / 32	94,20	1
837.005	20 / 26 / 32 / 40 / 45	192,60	1
837.007	16 / 20 / 26 / 32 / 40 / 45 / 50	265,55	1

8373 Expositor de tartas giratorio / Revolving cake stand /
Présentoir giratoire de tartes / Drehbarer Tortenständer



REF	Ø cm	H cm	€	U
837.300	30	8,00	61,20	1

350 Cedazos en acero inox / St/Steel sieves / Tamis en acier inox / Siebe aus rostfreiem Stahl

Detalle de las 6 mallas a escala real.
Detail of the 6 sieves at real scale.
Détail des 6 mailles à échelle réelle.
Detail der 6 Maschen in realer Skala.

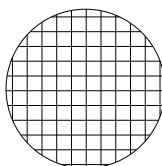

REF	Ø cm	Num	€	U
350.226	26	10	25,60	1
350.230	30	10	27,55	1
350.235	35	10	41,05	1
350.240	40	10	42,30	1

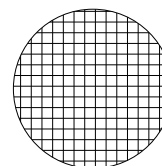

REF	Ø cm	Num	€	U
350.326	26	14	24,95	1
350.330	30	14	27,90	1
350.335	35	14	40,90	1
350.340	40	14	51,45	1

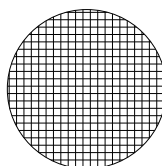

REF	Ø cm	Num	€	U
350.426	26	20	37,25	1
350.430	30	20	41,15	1
350.435	35	20	59,15	1
350.440	40	20	61,00	1

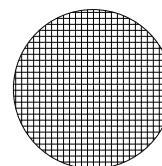

REF	Ø cm	Num	€	U
350.526	26	25	37,70	1
350.530	30	25	41,50	1
350.535	35	25	60,50	1
350.540	40	25	62,50	1

NUM.	LUZ DE MALLA / MESH SIZE / MAILLAGE / MASCHENWEITE (mm)
10	2,000
14	1,400
20	0,850
25	0,710
35	0,500
50	0,300

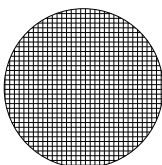

REF	Ø cm	Num	€	U
350.626	26	35	38,65	1
350.630	30	35	45,35	1
350.635	35	35	63,75	1
350.640	40	35	65,80	1

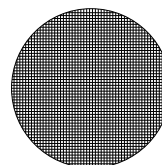

REF	Ø cm	Num	€	U
350.726	26	50	41,05	1
350.730	30	50	49,25	1
350.735	35	50	66,15	1
350.740	40	50	69,70	1

830 Embudo dosificador / Confectionery funnel / Entonnoir doseur / Dosierungstrichter



Ø 4 mm



830.001



830.002

REF	Lts	€	U
830.001	1,00	198,00	1
830.002	2,00	246,70	1

Boquilla recambio Ø 6 mm
Spare tube Ø 6 mm
Douille rechange Ø 6 mm
Austauschbare Öffnung Ø 6 mm

970 Soporte para embudo o chino / Stand for funnel or chinese colander / Support pour entonnoir ou chinois / Ständer für Trichter oder Sieb

Ver / See / Voir / Siehe 70



830.003 Embudo dosificador económico / Economic confectionery funnel / Entonnoir doseur économique / Ökonomischer Dosierungstrichter



Ø 4 cm

REF	Lts	€	U
830.003*	1,00	73,50	1
830.004**		7,05	1

*Boquilla de recambio Ø 6 mm.
Spare tube Ø 6 mm.
Douille de rechange Ø 6 mm.
Austauschbare Öffnung Ø 6 mm.

** Soporte embudo. Se vende por separado.
Stand for funnel. Sell separately.
Support pour entonnoir. Vendu séparément.
Trichterständer. Separater Verkauf.

830.005 Embudo dosificador básico con soporte / Basic confectionery funnel with stand / Entonnoir doseur de base avec support / Basisdosierungstrichter mit Ständer



REF	Lts	€	U
830.005	1,00	28,95	1

Embudo y soporte se venden conjuntamente.
Funnel and stand sold together.
Entonnoir et support vendu ensemble.
Trichter und Ständer werden zusammen verkauft.

9095 Rejilla inox pastelería con pies / St/steel pastry grid with feet /
Grille pâtisserie inox avec pieds / Patisserierost rostfreier Stahl mit Füßen



11 cm

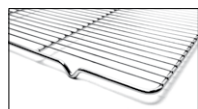

REF	mm	N. TRAVESAÑOS / N. CROSS-BARS / N. TRAVERSES / N. TRAVERSEN	Ø mm TRAVESAÑOS / Ø mm CROSS-BARS / Ø mm TRAVERSES / Ø mm TRAVERSEN	N. VARILLAS / N. WIRES / N. FILS / N. STÄBE	Ø mm VARILLAS / Ø mm WIRES / Ø mm FILS / Ø mm STÄBE	€	U
909.559	590 x 390 x 20	3	5	29	2	30,65	1

VER PRODUCTOS EN / SEE PRODUCTS ON / VOIR PRODUITS EN / SIEHE PRODUKTE IN

318

BANDEJA PASTELERÍA / BAKING SHEET /
PLAQUE À PÂTISSERIE / PATISSERIETABLETT



P. 52

1232

BANDEJA PARA PASTELERÍA CON BORDE 90° /
TRAY FOR CONFECTIONERY EDGE 90° /
PLAQUE À PÂTISSERIE BORD 90° /
PATISSERIETABLETT MIT 90° RAND



P. 53

1321

BANDEJA PASTELERÍA ANTIADHERENTE PERFORADA BORDE 45° /
PERFORATED NON-STICK TRAY FOR CONFECTIONERY. EDGE 45° /
PLAQUE À PÂTISSERIE ANTI-ADHÉSIF PERFORÉ. ANGLE 45° /
GELOCHTES PATISSERIETABLETT ANTIHAFT MIT 45° RAND



P. 54

9092

REJILLA GASTRONORM CON RILSAN BLANCO /
WHITE RILSAN STEEL GASTRONORM GRID /
GRILLE GASTRONORME EN ACIER ET RILSAN BLANC /
GASTRONORMROST WEISSES RILSAN



P. 54

972

PAPEL SILICONADO /
SILICONIZED BAKING RELEASE PAPERS /
PAPIER SILICONÉ ANTI-ADHÉSIF /
BACKPAPIER AUS SILIKON



P. 56

833

TAPETE DE SILICONA / NON-STICK SILICON MAT /
TOILE DE CUISSON // SILIKONMATTE



P. 56

331 Racionador de helado / Ice cream scoop / Cuillère à glace / Eiskugelportionierer



REF	Ø mm	Mlts	€	U
331.039	39	15	11,25	12
331.044	44	22	11,25	12
331.050	50	32	11,25	12
331.056	56	46	11,25	12
331.059	59	54	11,55	12
331.066	66	75	11,55	12
331.070	70	90	11,65	12

908 Pala helados acero inox / St/Steel ice cream spatula / Pelle à glace acier inox / Eisschaufel rostfreier Stahl



REF	COLOR / COLOUR / COULEUR FARBE	L cm	€	U
908.000	Blanca / White / Blanc / Weiss	26	7,35	1
908.001*	Transparente / Clear / Transparente / Transparent	26	7,35	1
908.002	Roja / Red / Rouge / Rot	26	7,35	1
908.003	Azul / Blue / Bleu / Blau	26	7,35	1
908.004	Amarilla / Yellow / Jaune / Gelb			



* Metacrilato /
* Methacrylate /
* Méthacrylate /
* Metaakrylat

332 Copa helado / Ice cream cup / Coupe à glace / Eisschale



Ref. 332.010

Ref. 332.095

REF	Ø cm	H cm	Lts	€	U
332.095	9,5	8,5	0,15	6,30	1
332.010	10,5	6	0,17	5,65	1

VER PRODUCTOS EN / SEE PRODUCTS ON /
VOIR PRODUITS EN / SIEHE PRODUKTE IN

GELATO 5K CREA SC

La mantecadora más compacta totalmente automática /
The most compact completely automatic ice-cream maker /
La turbine à glace la plus compacte totalement automatique /
Die kompakteste vollautomatische Eismaschine



P. 188-191

875 Soporte para cucuruchos / Cornet stand / Support pour cornets / Eiswaffelständer



Ref. 875.003



Ref. 875.004

REF	cm	€	U
875.003	21 x 7 x 8,5	19,35	1
875.004	12 x 12 x 7,5	18,55	1

Ø 1 25 mm
Ø 2 32 mm

914 360 x 165 mm



Acero inox 18/10
18/10 St/Steel
Acier inox 18/10
Edelstahl 18/10

REF	mm	H mm	Lts	€	U
914.080	360 x 165	80	3,4	18,75	10
914.120	360 x 165	120	5	23,55	10
914.150	360 x 165	150	7	28,60	10

915 360 x 250 mm



Acero inox 18/10
18/10 St/Steel
Acier inox 18/10
Edelstahl 18/10

REF	mm	H mm	Lts	€	U
915.080	360 x 250	80	5,4	22,95	10
915.120	360 x 250	120	8	32,00	10
915.150	360 x 250	150	11	41,20	10

9161 360 x 165 mm



Policarbonato.
Polycarbonate.
Polycarbonate.
Polycarbonat.

REF	mm	H mm	Lts	€	U
916.120	360 x 165	120	5	9,80	10

917 360 x 250 mm



Policarbonato.
Polycarbonate.
Polycarbonate.
Polycarbonat.

REF	mm	H mm	Lts	€	U
917.080	360 x 250	80	3,4	10,65	10

9160 Tapa policarbonato /
Polycarbonate lid /
Couvercle en polycarbonate /
Deckel Polycarbonat



Adaptable a cubetas heladería inox y policarbonato.
Adjustable for St/Steel Ice cream containers.
Adaptable aux récipient à glace en acier inox.
Passend für Eisbehälter Edelstahl und Polycarbonat.

REF	mm	€	U
916.000	360 x 165	10,00	10

918 Lava-rationador acero inoxidable /
St/steel scoop-washer /
Rince-cuillères acier inoxydable /
Eisportioniererspüle rostfreier Stahl



REF	mm	€	U
918.000	375 x 195 x 270	301,65	1

7022 Molde cake profesional /
Professional cake mould /
Cake embouti professionnel /
Professionelle Backform



REF	cm (int.)	H cm	Lts	€	U
702.218	18 x 7,5	6,0	0,7	10,40	1
702.224	24 x 9	7,5	1,4	12,05	1
702.230	30 x 10,5	8,0	2,0	15,45	1

702 Molde cake /
Cake mould /
Cake embouti /
Backform



REF	cm	H cm	€	U
702.026	26 x 9,5	7,5	16,85	1
702.028	28 x 10	7,5	17,65	1

704 Molde para paté o cake desmontable /
Folding cake mould /
Pâté ou cake démontable /
Backform für Pastete oder Kuchen demontierbar



REF	cm	H cm	€	U
704.024	24 x 9,5	7,0	30,90	1
704.030	30 x 10	7,5	31,50	1

709 Molde fondo desmontable /
Baking mould w/removable base /
Tarte maison a/fond amovible /
Backform Boden demontierbar



REF	cm	H cm	€	U
709.035	35 x 11	2,5	15,15	1

707 Placa madalenas pequeñas /
Small madeleine sheet /
Plaque madeleinettes /
Backblech kleine Madeleine



REF	cm	€	U
707.039	39,5 x 12,5	18,55	6

2 hileras de 10 madalenas pequeñas de 4,2 cm.
2 rows of 10 small madeleines of 4,2 cm.
2 rangées de 10 madeleinettes de 4,2 cm.
2 Reihen von 10 kleinen Madeleinen von 4,2 cm.

706 Placa madalenas /
Madeleine sheet /
Plaque madeleines /
Backblech Madeleine



REF	cm	€	U
706.039	39,5 x 20	21,00	6

2 hileras de 6 madalenas de 8 cm.
2 rows of 6 madeleines of 8 cm.
2 rangées de 6 madeleines de 8 cm.
2 Reihen von 6 Madeleinen von 8 cm.

723 Molde desmontable Antiadherente /
Non-stick spring form /
Moule rond démontable /
Demontierbare Backform Antihaft



REF	Ø cm	H cm	€	U
723.024	24	7,0	11,85	1
723.028	28	7,0	12,75	1

703 Molde para tarta /
High cake mould /
Manqué rond uni /
Tortenbackform



REF	Ø cm	H cm	€	U
703.012	12	3,0	3,95	1
703.016	16	4,0	8,35	1
703.020	20	4,5	11,35	1
703.024	24	5,0	14,05	1
703.028	28	5,0	15,55	1
703.032	32	5,5	22,25	1

710 Molde rizado para tarta /
Round tart mould with fluted edges /
Tourtière ronde avec Bord cannelé /
Runde Ecken Tortenbackform



REF	Ø cm	H cm	€	U
710.020	20	2,5	7,00	1
710.024	24	2,5	9,35	1
710.028	28	2,5	11,35	1
710.032	32	2,5	13,35	1

711 Molde rizado fondo desmontable /
Fluted edge mould with removable base /
Tourtière avec fond amovible /
Runde Ecken Backform Boden demontierbar

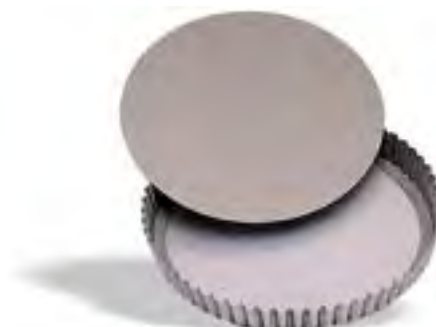

REF	Ø cm	H cm	€	U
711.010	10	1,8	4,45	1
711.012	12	2,0	4,95	1
711.020	20	2,5	11,35	6
711.024	24	2,5	16,05	6
711.028	28	2,5	21,20	6
711.032	32	2,5	22,95	6

701 Flanero rizado 14 costados /
14 Wide ribs brioche mould /
Brioche 14 côtes /
Briochebackform mit 14 Rundungen



REF	Ø cm	H cm	Lts	€	U
701.014	14	5,5	0,40	6,20	6
701.016	16	6,5	0,55	7,75	6
701.018	18	6,5	0,65	8,85	6
701.020	20	8,3	1,00	12,25	6
701.022	22	10,0	1,50	16,55	6

708 Molde savarin / Savarin mould /
Moule savarin / Savarin Backform



REF	Ø cm	H cm	€	U
708.008	8	2,0	4,05	1
708.012	12	2,5	4,75	1
708.022	22	4,5	16,65	1
708.024	24	5,0	17,50	1
708.026	26	6,2	18,75	1

712 Molde savarin "trois frères" /
"Trois frères" ring mould /
Moule savarin "trois frères" /
Savarin Backform "trois frères"



REF	Ø cm	H cm	€	U
712.022	22	5,5	22,55	6

VER PRODUCTOS EN / SEE PRODUCTS ON /
VOIR PRODUITS EN / SIEHE PRODUKTE IN

MAQUINARIA / MACHINERY /
MACHINES / MASCHINEN



P. 198

715 Molde redondo para bizcocho / Baba mould /
Baba rond / Baba Backform



REF	Ø cm	H cm	€	U
715.006	6,5	6,0	5,05	6

Borde vuelto.
Rolled edge.
Bord roulé.
Gerollter Rand.

713 Molde ovalado para aspic / Oval aspic mould /
Moule aspic ovale / Ovale Backform für Aspic



REF	cm	H cm	€	U
713.075	7,5 x 5,5	3,8	3,50	6

714 Molde ovalado para aspic con fondo estrellado /
Oval aspic mould with star bottom /
Moule aspic ovale avec fond étoilé /
Ovale Backform für Aspic mit Sternboden



REF	cm	H cm	€	U
714.075	7,5 x 5,5	3,8	4,05	6

718 Molde madalenas con 10 costados /
10 Wide ribs brioche mould /
Moule brioche 10 côtes /
Madeleinenbackform 10 Rundungen



Ø 6: 9 costados. Resto ø: 10 costados / Ø 6: 9 ribs. Other ø: 10 ribs /
Ø 6: 9 côtes. Autres ø: 10 côtes / Ø 6: 9 Rundungen. Resto ø: 10 Rundungen

REF	Ø cm	H cm	€	U
718.006	6	2,5	1,25	6
718.008	8	3,2	2,00	6
718.010	10	3,8	2,30	6
718.011	11	4,0	2,60	6

717 Molde barquita lisa / Plain oval boat mould /
Moule Barquette unie / Glatte Schiffchenbackform



REF	cm	H cm	€	U
717.008	8 x 3,3	1,2	1,55	6
717.010	10 x 4,3	1,3	1,75	6
717.012	12 x 5	1,3	2,10	6

721 Molde tartaleta redonda lisa /
Round plain tart mould /
Moule tartelette ronde unie /
Glatte runde Törtchenbackform



REF	Ø cm	H cm	€	U
721.005	5	1,2	1,15	6
721.006	6	1,2	1,55	6
721.007	7	1,2	1,75	6
721.008	8	1,2	2,00	6
721.010	10	1,2	2,40	6

719 Molde para empanadas / Friand mould /
Moule Friand / Backform für Teigpasteten



REF	cm	€	U
719.009	10 x 5	2,10	6

716 Molde barquita acanalada /
Fluted oval boat mould /
Moule barquette cannelée /
Ovale Schiffchenbackform mit runden Ecken



REF	cm	H cm	€	U
716.008	8 x 4	1,0	1,05	6
716.010	10 x 4,5	1,0	1,25	6
716.012	12 x 5	1,4	1,45	6

720 Molde tartaleta acanalada redonda /
Round fluted tart mould /
Moule tartelette ronde cannelée /
Törtchenbackform mit runden Ecken



REF	Ø cm	H cm	€	U
720.005	5	1,2	1,15	6
720.006	6	1,2	1,45	6
720.007	7	1,2	1,55	6
720.008	8	1,2	1,65	6
720.010	10	1,8	2,20	6
720.012	12	2,0	2,90	6

VER PRODUCTOS EN / SEE PRODUCTS ON /
VOIR PRODUITS EN / SIEHE PRODUKTE IN

JARRAS DE MEDIDAS / MEASURING JUGS /
POTS MESUREURS / MESSBECHER



P. 82

740 Ovalado con varios costados / Ribbed oval /
Ovale à côtes / Oval mit verschiedenen Rändern



REF	L cm	€	U
740.045	4,5	0,95	6

743 Ovalado acanalado / Fluted oval /
Ovale cannelé / Oval mit runden Ecken



REF	L cm	€	U
743.045	3,5	0,95	6

747 Redondo liso / Plain round /
Rond uni / Glatte Backform



REF	Ø cm	€	U
747.040	4	1,05	6

749 Rombo liso / Plain diamond /
Losange uni / Glatter Rhombus



REF	L cm	€	U
749.060	6	1,05	6

751 Barquilla para pastelillo /
Diamond-shaped boat /
Bateau calisson /
Schiffchen für Pastetchen



REF	L cm	€	U
751.060	6	1,05	6

741 Cuadrado acanalado / Fluted square /
Carre cannelé / Quadrat mit runden Ecken



REF	L cm	€	U
741.035	3,5	0,95	6

746 Redondo hueco / Deep plain round /
Rond creux / Rundes Loch



REF	Ø cm	€	U
746.035	3,5	1,05	6

748 Rectángulo liso / Plain rectangle /
Rectangle uni / Glattes Rechteck



REF	L cm	€	U
748.050	5	1,05	6

750 Bomba con varios costados / Ribbed dome /
Dôme à côtes / Dom mit verschiedenen Rändern



REF	Ø cm	€	U
750.045	4,5	1,05	6

Caja de 60 pequeños moldes "Petits fours" /
60 "Petits fours" moulds set /

722 Boîte de 60 "petits fours" /
Kisten mit 60 kleinen Backformen "Petits fours"



5 Piezas de cada uno de los 12 "Petits fours".
5 Pieces of each 12 "Petits fours".
5 Pièces de chacun des 12 "Petits fours".
5 Teile von jeden 12 "Petits fours".

REF	€	U
722.000	64,35	1



Caja de 8 cortapastas redondos lisos /
Set of 8 round plain cutters /

732 Boîte de 8 découpoirs ronds unis /
Kiste mit 8 runden glatten Teigausstechformen

INOX - ST/STEEL
ROSTFREIER STAHL



REF	Ø cm	H cm	€	U
732.000	3 / 4 / 5 / 6 / 7 / 8 / 9 / 10	3,5	40,00	1

Caja de 8 cortapastas redondos rizados /
Set of 8 round fluted cutters /

733 Boîte de 8 découpoirs ronds cannelés /
Kiste mit 8 Teigausstechformen mit runden Ecken

INOX - ST/STEEL
ROSTFREIER STAHL



REF	Ø cm	H cm	€	U
733.000	3 / 4 / 5 / 6 / 7 / 8 / 9 / 10	3,5	50,60	1

Caja 9 cortapastas redondos lisos poliglas /
9 pcs set polyglass plain cutters /

796 Boîte 9 découpoirs ronds unis polyglass /
Kiste mit 9 runden glatten Teigausstechformen Polyglas



REF	Ø cm	H cm	€	U
796.000	2 / 3 / 4 / 5 / 6 / 7 / 8 / 9 / 10	3,5	30,90	1

Caja 9 cortapastas redondos rizados poliglas /
9 pcs set polyglass fluted cutters /

7961 Boîte 9 découpoirs ronds cannelés polyglass /
Kiste mit 9 Polyglas Teigausstechformen mit runden Ecken



REF	Ø cm	H cm	€	U
796.100	2 / 3 / 4 / 5 / 6 / 7 / 8 / 9 / 10	3,5	30,90	1

Caja 7 cortapastas ovalados poliglas /
7 pcs set polyglass oval cutters /

799 Boîte 7 découpoirs ovales polyglass /
Kiste mit 7 ovalen glatten Teigausstechformen Polyglas



REF	Ø cm	H cm	€	U
799.000	3 x 2 / 4,5 x 3 / 6 x 3,5 / 7,5 x 4,5 / 9 x 5,5 / 10,5 x 6,5 / 12 x 7,5	3,5	30,90	1

Caja 7 cortapastas ovalados rizados poliglas /
7 pcs set polyglass oval fluted cutters /

7991 Boîte 7 découpoirs ovales cannelés polyglass /
Kiste mit 7 ovalen Polyglas Teigausstechformen mit runden Ecken



REF	Ø cm	H cm	€	U
799.100	3 x 2 / 4,5 x 3 / 6 x 3,5 / 7,5 x 4,5 / 9 x 5,5 / 10,5 x 6,5 / 12 x 7,5	3,5	30,90	1

780 Aro redondo para tarta / Tart ring / Cercle à tarte / Runder Tortenring



REF	Ø cm	H cm	€	U
780.006	6	2,0	3,30	1
780.008	8	2,0	3,40	1
780.010	10	2,0	3,50	1
780.012	12	2,0	3,95	1
780.014	14	2,0	4,85	1
780.016	16	2,0	5,25	1
780.018	18	2,0	5,65	1
780.020	20	2,0	6,00	1
780.024	24	2,0	6,70	1
780.028	28	2,0	7,25	1

781 Aro redondo para tarta / "Entremets" ring / Cercle à entremets / Runder Tortenring



REF	Ø cm	H cm	€	U
781.006	6	3,5	3,95	1
781.008	8	3,5	4,05	1
781.010	10	3,5	4,15	1
781.012	12	3,5	4,65	1
781.014	14	3,5	5,25	1
781.016	16	3,5	5,65	1
781.018	18	3,5	6,00	1
781.020	20	3,5	6,30	1

785 Aro redondo para mousse / Mousse ring / Cercle à mousse / Runder Moussering



REF	Ø cm	H cm	€	U
785.006	6	4,0	4,05	1
785.008	8	4,0	4,25	1
785.010	10	4,0	4,45	1
785.012	12	4,0	4,75	1
785.014	14	4,0	5,25	1
785.016	16	4,0	5,55	1
785.018	18	4,0	6,10	1
785.020	20	4,0	6,60	1

782 Aro redondo para mousse / Mousse ring / Cercle à mousse / Runder Moussering



REF	Ø cm	H cm	€	U
782.075	7,5	4,0	4,05	1
782.008	8	4,5	4,25	1
782.010	10	4,5	4,65	1
782.012	12	4,5	5,05	1
782.014	14	4,5	5,45	1
782.016	16	4,5	5,90	1
782.018	18	4,5	6,80	1
782.020	20	4,5	7,85	1
782.022	22	4,5	8,50	1
782.024	24	4,5	8,95	1
782.026	26	4,5	9,40	1
782.028	28	4,5	9,95	1

783 Aro redondo para tarta / Ice cream cake ring / Cercle à vacherin / Runder Tortenring



REF	Ø cm	H cm	€	U
783.006	6	6,0	6,50	1
783.008	8	6,0	6,60	1
783.010	10	6,0	6,60	1
783.012	12	6,0	6,60	1
783.014	14	6,0	7,35	1
783.016	16	6,0	7,85	1
783.018	18	6,0	8,35	1
783.020	20	6,0	10,05	1
783.022	22	6,0	10,85	1
783.024	24	6,0	11,65	1
783.026	26	6,0	12,20	1
783.028	28	6,0	13,05	1
783.030	30	6,0	18,00	1



Perfecto para presentación de platos /
 Perfect for dishes presentation /
 Idéal pour la présentation de plats /
 Perfekt für die Tellerpräsentation

765 Molde hexagonal / Hexagon / Hexagone / Sechseckige Form

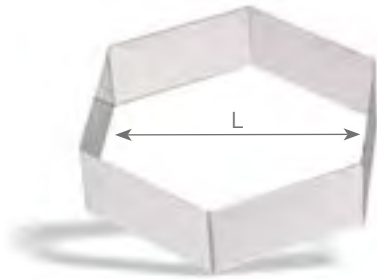

REF	L cm	H cm	€	U
765.008	8	4,5	8,55	1
765.010	10	4,5	9,05	1
765.016	16	4,5	9,80	1
765.018	18	4,5	9,90	1
765.020	20	4,5	10,20	1
765.022	22	4,5	11,05	1
765.024	24	4,5	12,05	1

768 Molde forma lágrima / Tear / Larne / Tränenform

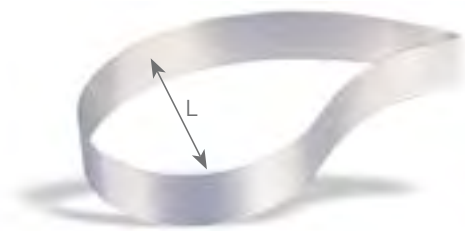

REF	L cm	H cm	€	U
768.006	6	4,5	6,40	1
768.008	8	4,5	6,70	1
768.016	16	4,5	9,05	1

770 Molde forma gota / Drop / Goutte / Tropfenform



REF	L cm	H cm	€	U
770.006	6	4,5	6,30	1
770.008	8	4,5	6,90	1
770.014	14	4,5	8,45	1

769 Molde forma corazón / Heart / Coeur / Herzform

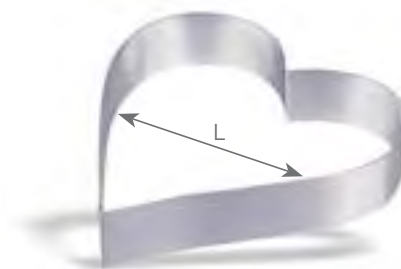

REF	L cm	H cm	€	U
769.008	8	4,5	8,55	1
769.010	10	4,5	8,75	1
769.018	18	4,5	9,90	1
769.020	20	4,5	10,20	1
769.022	22	4,5	11,05	1

771 Molde forma oval / Oval / Ovale / Ovalform

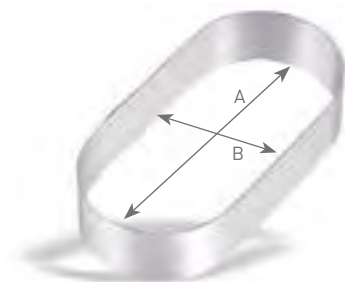

REF	L cm	H cm	€	U
771.025	25 x 11,2	4,5	13,95	1

786 Triángulo bombeado / Convex triangle / Triangle bombé / Gewölbtes Dreiecksform



REF	L cm	H cm	€	U
786.010	10	4,5	8,55	1
786.012	12	4,5	8,75	1

787 Cuadrado bombeado / Convex square / Carré bombé / Gewölbtes Quadrat



REF	L cm	H cm	€	U
787.006	6	4,5	7,75	1
787.008	8	4,5	8,05	1
787.010	10	4,5	8,55	1
787.014	14	4,5	8,75	1
787.020	20	4,5	9,80	1

992 Cinta PVC para mousse / PVC ribbon for mousse / Ruban pâtissier en PVC / PVC Band für Mousse



REF	LONGITUD / LENGTH / LONGUEUR / LÄNGE	H cm	€	U
992.035	100 m	3,5	26,25	1
992.040	100 m	4,0	29,45	1
992.045	100 m	4,5	33,00	1
992.050	100 m	5,0	34,30	1

355 Flanero / Caramel cream mould / Moule à flan / Karamellcremeform

INOX - ST/STEEL
ROSTFREIER STAHL



REF	Ø cm	H cm	Lts	€	U
355.007	7,5	5,2	0,12	2,40	10
355.008	8,5	5,4	0,17	2,95	10

3551 Flanero reforzado / Heavy duty caramel cream mould / Moule à flan renforcé / Verstärkte Karamellcremeform

INOX - ST/STEEL
ROSTFREIER STAHL



REF	Ø cm	H cm	Lts	€	U
355.107	7	5,5	0,14	3,00	1
355.108	8	5,8	0,22	3,70	1

136 Molde industrial para flan / Reinforced caramel cream mould / Moule à flan / Industrielle Karamellcremeform

ALUMINIO /
ALUMINIUM



REF	Ø cm	H cm	Lts	€	U
136.006	6	5,5	0,10	1,85	1
136.007	7	6,5	0,15	2,10	1
136.008	8	6,5	0,25	2,40	1

784 Molde cake / Cake mould / Moule à cake / Kuchenbackform



REF	cm	€	U
784.020	20 x 13 x 8	13,15	1
784.025	25 x 13 x 8	14,65	1
784.030	30 x 13 x 8	19,95	1
784.035	35 x 13 x 8	22,65	1
784.040	40 x 13 x 8	23,85	1

764 Molde semiesférico / Hemispherical mould / Demi-sphérique / Halbkugelform



REF	Ø cm	H cm	Lts	€	U
764.004	4	2,0	0,015	3,10	1
764.006	6	3,0	0,050	3,40	1
764.008	8	4,0	0,130	5,45	1
764.010	10	5,0	0,260	7,95	1
764.012	12	6,2	0,450	13,55	1
764.014	14	6,7	0,700	17,30	1

788 Molde 1/2 caña desmontable triangular / Triangle cake mould / Gouttière triangulaire / Dreieckige demontierbare Backform



REF	cm	€	U
788.025	25 x 9 x 6	32,20	1
788.050	50 x 9 x 6	38,90	1

789 Molde 1/2 caña desmontable redondo / Round cake mould / Gouttière ronde / Halbrunde demontierbare Backform



REF	cm	€	U
789.025	25 x 9 x 6	32,20	1
789.050	50 x 9 x 6	38,90	1



825 Conjunto decorador pastelería / Pastry decoration set 3 /
Kit décoration pâtisserie / Set Patisseriedekorierung



REF	mm	Lts	€	U
825.000	120 x 55	0,10	7,25	1

Incluye 3 sets completos de boquilla dispensador flexible.
Includes 3 decoraton complete kits with tubes and flexible distributor
3 kits compléts décor avec .
douilles et distributeur flexible compris.
Inklusive 3 komplette Sets von flexiblen Spritztüllen.

826 Juego pistola repostería / Cooking press cum icing set /
Pistolet pour pâtisserie / Spritztüllenset



REF	mm	€	U
826.000	220 x 60	20,55	1

800 Mangas de nylon / Nylon pastry bags / Poches pâtisseries en nylon / Nylon Spritzbeutel



REF	cm	€	U
800.030	30	4,35	6
800.035	35	5,05	6
800.040	40	5,65	6
800.045	45	6,70	6
800.050	50	7,55	6
800.055	55	8,15	6
800.060	60	9,15	6
800.065	65	10,30	6
800.070	70	11,85	6

Fabricadas en nylon y recubiertas de poliuretano por una cara. Impermeables y ultraligeras. Son muy cómodas de utilizar.

Se pueden hervir. Sin costuras, termosoldadas de larga duración y con la punta ajustable.

Made in nylon and covered with polyurethane on one side. Waterproof, ultra light and very comfortable to use. Sterilizable, without seams, thermowelded for long life and with an adjustable end.

Fabriquées en tissu de nylon avec un revêtement polyuréthane sur une face. Impérmeables, très souples,

ultralégères et très comodes au tact. Stérilisables, sans coutures, thermosoudées, de longue durée et avec l'embout ajustable.

Hergestellt aus Nylon und auf einer Seite mit Polyurethan beschichtet. Undurchlässig und ultraleicht. Sie sind sehr einfach zu benutzen.

Sie lassen sich abkochen. Ohne Nähte, langlebige Hitzeverschweißung mit einer anpassbaren Spitze.

851 Manga pastelera de algodón / Cotton pastry bag / Poches pâtisseries en cotton / Baumwolle Spritzbeutel



REF	L cm	€	U
851.028	28	5,05	1
851.034	34	5,75	1
851.040	40	7,15	1
851.046	46	8,45	1
851.050	50	9,65	1
851.055	55	10,30	1
851.060	60	13,05	1
851.065	65	14,95	1

798 Mangas desechables / Disposable pastry bags / Poches jetables / Einweg Spritzbeutel



REF	cm	Lts	€	U
798.040	43	2,00	16,55	1
798.055	55	3,50	24,10	1
798.065	65	5,00	31,90	1

Caja de 100 unidades.

100 pieces set.

Boîte de 100 pièces.

Kiste von 100 Stück.

849 Soporte para mangas pasteleras y boquillas / Support for pastry bags and tubes (nozzles) / Support pour pochés pâtisseries et douilles / Ständer für Spritzbeutel und Tüllen



REF	€	U
849.000	12,15	1

810 Boquilla redonda / Plain tube / Douille unie / Rundtülle

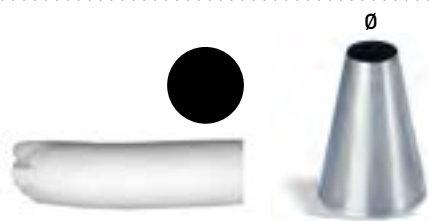

REF	Ø mm	€	U
810.002	2	2,70	25
810.004	4	2,70	25
810.006	6	2,70	25
810.008	8	2,70	25
810.010	10	2,70	25
810.012	12	2,70	25
810.014	14	2,70	25
810.016	16	2,70	25

811 Boquilla estrella / Star tube / Douille cannelée / Sterntülle



REF	Ø mm	Nº PUNTAS / Nº TEETH / Nº DENTS / Nº ECKEN	€	U
811.002	2	6	2,70	25
811.004	4	6	2,70	25
811.006	6	6	2,70	25
811.008	8	6	2,70	25
811.010	10	7	2,70	25
811.012	12	7	2,70	25
811.014	14	8	2,70	25
811.016	16	9	2,70	25
811.018	18	10	2,70	25

812 Boquilla estrella cerrada / Closed star tube / Douille cannelée fermée / Geschlossene Sterntülle



REF	Ø mm	Nº PUNTAS / Nº TEETH / Nº DENTS / Nº ECKEN	€	U
812.003	3	6	2,70	25
812.005	5	6	2,70	25
812.007	7	6	2,70	25
812.009	9	8	2,70	25
812.011	11	8	2,70	25

813 Boquilla cinta estrella / Yule log tube / Douille à bûche de Noël / Sternbandtülle

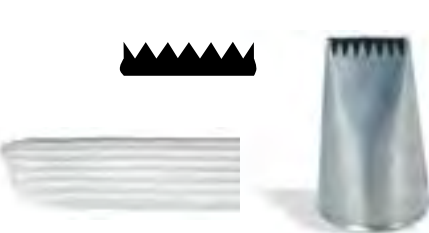

REF	mm	Nº PUNTAS / Nº TEETH / Nº DENTS / Nº ECKEN	€	U
813.016	16 x 2	6	2,70	25
813.020	20 x 3	6	2,70	25
813.028	28 x 4	6	2,70	25

816 Boquilla flor / Flower tube / Douille fleur / Blumentülle



REF	Ø mm	Nº PUNTAS / Nº TEETH / Nº DENTS / Nº ECKEN	€	U
816.011	11	6	2,70	25
816.013	13	8	2,70	25
816.015	15	9	2,70	25

817 Boquilla flor cerrada / Closed flower tube / Douille fleur fermée / Geschlossene Blumentülle



REF	Ø mm	Nº PUNTAS / Nº TEETH / Nº DENTS / Nº ECKEN	€	U
817.005	5	6	2,70	25
817.006	6	8	2,70	25
817.008	8	9	2,70	25

815 Boquilla rizada / "petits fours" tube / Douille à "petits fours" / Tülle "petits fours"



REF	Ø mm	Nº PUNTAS / Nº TEETH / Nº DENTS / Nº ECKEN	€	U
815.004	4	9	2,70	25
815.006	6	9	2,70	25
815.009	9	12	2,70	25
815.012	12	15	2,70	25
815.015	15	16	2,70	25
815.018	18	18	2,70	25

814 Boquilla para relleno / Bismark tube / Douille petit chou / Fülltülle

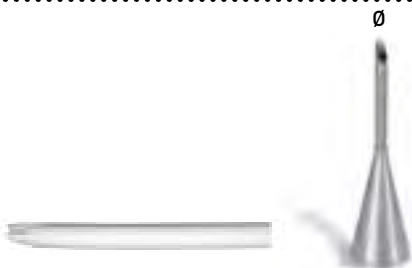





REF	Ø mm	€	U
814.000	4	4,15	25

820 Conjunto de 6 boquillas nº 0 / Set of 6 tubes nr. 0 / Boîte de 6 douilles num. 0 / Set von 6 Tüllen Nr. 0



REF	€	U
820.000	16,15	1

Los gráficos de los diámetros de los agujeros de salida de las boquillas son a tamaño real / Diameter exit holes of the tubes are drawn at real size.
Les graphiques des diamètres des embouts de sortie des douilles sont en taille réelle / Der abgebildete Durchmesser der Öffnungen entspricht der realen Größe.





- | | | |
|--|--|--|
| <ul style="list-style-type: none"> ● 1 Boquilla redonda 4 mm 1 Plain tube 4 mm 1 Douille unie 4 mm 1 Rundtülle 4 mm |  <ul style="list-style-type: none"> 1 Boquilla cinta estrella 20 x 3 mm 1 Yule log 20 x 3 mm 1 Douille à bûche de Noël 20 x 3 mm 1 Sternbandtülle 20 x 3 mm |  <ul style="list-style-type: none"> 1 Boquilla estrella 12 mm 1 Star tube 12 mm 1 Douille cannelée 12 mm 1 Sterntülle 12 mm |
|  <ul style="list-style-type: none"> 1 Boquilla estrella 8 mm 1 Star tube 8 mm 1 Douille cannelée 8 mm 1 Sterntülle 8 mm |  <ul style="list-style-type: none"> 1 Boquilla redonda 8 mm 1 Plain tube 8 mm 1 Douille unie 8 mm 1 Rundtülle 8 mm |  <ul style="list-style-type: none"> 1 Boquilla flor 11 mm 1 Flower tube 11 mm 1 Douille fleur 11 mm 1 Blumentülle 11 mm |

821 Conjunto de 6 boquillas nº 1 / Set of 6 tubes nr. 1 / Boîte de 6 douilles num. 1 / Set von 6 Tüllen Nr. 1



REF	€	U
821.000	16,15	1

Los gráficos de los diámetros de los agujeros de salida de las boquillas son a tamaño real / Diameter exit holes of the tubes are drawn at real size.
Les graphiques des diamètres des embouts de sortie des douilles sont en taille réelle / Der abgebildete Durchmesser der Öffnungen entspricht der realen Größe.

- | | | |
|---|---|---|
| <ul style="list-style-type: none"> ● 1 Boquilla redonda 2 mm 1 Plain tube 2 mm 1 Douille unie 2 mm 1 Rundtülle 2 mm |  <ul style="list-style-type: none"> 1 Boquilla redonda 6 mm 1 Plain tube 6 mm 1 Douille unie 6 mm 1 Rundtülle 6 mm |  <ul style="list-style-type: none"> 1 Boquilla redonda 10 mm 1 Plain tube 10 mm 1 Douille unie 10 mm 1 Rundtülle 10 mm |
|  <ul style="list-style-type: none"> 1 Boquilla redonda 4 mm 1 Plain tube 4 mm 1 Douille unie 4 mm 1 Rundtülle 4 mm |  <ul style="list-style-type: none"> 1 Boquilla redonda 8 mm 1 Plain tube 8 mm 1 Douille unie 8 mm 1 Rundtülle 8 mm |  <ul style="list-style-type: none"> 1 Boquilla redonda 12 mm 1 Plain tube 12 mm 1 Douille unie 12 mm 1 Rundtülle 12 mm |

822 Conjunto de 6 boquillas nº 2 / Set of 6 tubes nr. 2 /
Boîte de 6 douilles num. 2 / Set von 6 Tüllen Nr. 2



REF	€	U
822.000	16,15	1

Los gráficos de los diámetros de los agujeros de salida de las boquillas son a tamaño real / Diameter exit holes of the tubes are drawn at real size
Les graphiques des diamètres des embouts de sortie des douilles sont en taille réelle / Der abgebildete Durchmesser der Öffnungen entspricht der realen Grösse.

- | | | | | | |
|--|--|--|--|--|--|
| <ul style="list-style-type: none"> ★ 1 Boquilla estrella 2 mm 1 Star tube 2 mm 1 Douille cannelée 2 mm 1 Sterntülle 2 mm | <ul style="list-style-type: none"> ★ 1 Boquilla estrella 4 mm 1 Star tube 4 mm 1 Douille cannelée 4 mm 1 Sterntülle 4 mm | <ul style="list-style-type: none"> ★ 1 Boquilla estrella 6 mm 1 Star tube 6 mm 1 Douille cannelée 6 mm 1 Sterntülle 6 mm | <ul style="list-style-type: none"> ★ 1 Boquilla estrella 8 mm 1 Star tube 8 mm 1 Douille cannelée 8 mm 1 Sterntülle 8 mm | <ul style="list-style-type: none"> ★ 1 Boquilla estrella 10 mm 1 Star tube 10 mm 1 Douille cannelée 10 mm 1 Sterntülle 10 mm | <ul style="list-style-type: none"> ★ 1 Boquilla estrella 12 mm 1 Star tube 12 mm 1 Douille cannelée 12 mm 1 Sterntülle 12 mm |
|--|--|--|--|--|--|

823 Conjunto de 6 boquillas nº 3 / Set of 6 tubes nr. 3 /
Boîte de 6 douilles num. 3 / Set von 6 Tüllen Nr. 3



REF	€	U
823.000	16,15	1

Los gráficos de los diámetros de los agujeros de salida de las boquillas son a tamaño real / Diameter exit holes of the tubes are drawn at real size
Les graphiques des diamètres des embouts de sortie des douilles sont en taille réelle / Der abgebildete Durchmesser der Öffnungen entspricht der realen Grösse.

- | | | | | | |
|--|--|---|---|--|---|
| <ul style="list-style-type: none"> ★ 1 Boquilla rizada 12 mm 1 "Petits fours" tube 12 mm 1 Douille à "petits fours" 12 mm 1 Tülle "petits fours" 12 mm | <ul style="list-style-type: none"> ★ 1 Boquilla flor 13 mm 1 Flower tube 13 mm 1 Douille fleur 13 mm 1 Blumentülle 13 mm | <ul style="list-style-type: none"> ★ 1 Boquilla estrella cerrada 7 mm 1 Closed star tube 7 mm 1 Douille cannelée fermée 7 mm 1 Geschlossene Sterntülle 7 mm | <ul style="list-style-type: none"> ★ 1 Boquilla flor cerrada 6 mm 1 Closed flower tube 6 mm 1 Douille fleur fermée 6 mm 1 Geschlossene Blumentülle 6 mm | <ul style="list-style-type: none"> ★ 1 Boquilla estrella 8 mm 1 Star tube 8 mm 1 Douille cannelée 8 mm 1 Sterntülle 8 mm | <ul style="list-style-type: none"> ● 1 Boquilla redonda 10 mm 1 Plain tube 10 mm 1 Douille unie 10 mm 1 Rundtülle 10 mm |
|--|--|---|---|--|---|

824 Conjunto de 12 boquillas nº 4 / Set of 12 tubes nr. 4 /
Boîte de 12 douilles num. 4 / Set von 12 Tüllen Nr. 4



REF	€	U
824.000	31,80	1

Los gráficos de los diámetros de los agujeros de salida de las boquillas son a tamaño real / Diameter exit holes of the tubes are drawn at real size
Les graphiques des diamètres des embouts de sortie des douilles sont en taille réelle / Der abgebildete Durchmesser der Öffnungen entspricht der realen Grösse.

- | | | |
|--|---|---|
| <ul style="list-style-type: none"> ● 1 Boquilla redonda 6 mm 1 Plain tube 6 mm 1 Douille unie 6 mm 1 Rundtülle 6 mm | <ul style="list-style-type: none"> ★ 1 Boquilla estrella cerrada 7 mm 1 Closed star tube 7 mm 1 Douille cannelée fermée 7 mm 1 Geschlossene Sterntülle 7 mm | <ul style="list-style-type: none"> ★ 1 Boquilla rizada 15 mm 1 "Petits fours" tube 15 mm 1 Douille à "petits fours" 15 mm 1 Tülle "petits fours" 15 mm |
| <ul style="list-style-type: none"> ● 1 Boquilla redonda 10 mm 1 Plain tube 10 mm 1 Douille unie 10 mm 1 Rundtülle 10 mm | <ul style="list-style-type: none"> ★ 1 Boquilla estrella cerrada 11 mm 1 Closed star tube 11 mm 1 Douille cannelée fermée 11 mm 1 Geschlossene Sterntülle 11 mm | <ul style="list-style-type: none"> ★ 1 Boquilla flor 11 mm 1 Flower tube 11 mm 1 Douille fleur 11 mm 1 Blumentülle 11 mm |
| <ul style="list-style-type: none"> ★ 1 Boquilla estrella 8 mm 1 Star tube 8 mm 1 Douille cannelée 8 mm 1 Sterntülle 8 mm | <ul style="list-style-type: none"> ★ 1 Boquilla cinta estrella 20 mm 1 Yule log tube 20 mm 1 Douille à bûche de Noël 20 mm 1 Sternbandtülle 20 mm | <ul style="list-style-type: none"> ★ 1 Boquilla flor 15 mm 1 Flower tube 15 mm 1 Douille fleur 15 mm 1 Blumentülle 15 mm |
| <ul style="list-style-type: none"> ★ 1 Boquilla estrella 12 mm 1 Star tube 12 mm 1 Douille cannelée 12 mm 1 Sterntülle 12 mm | <ul style="list-style-type: none"> ★ 1 Boquilla rizada 9 mm 1 "Petits fours" tube 9 mm 1 Douille à "petits fours" 9 mm 1 Tülle "petits fours" 9 mm | <ul style="list-style-type: none"> ★ 1 Boquilla flor cerrada 8 mm 1 Closed flower tube 8 mm 1 Douille fleur fermée 8 mm 1 Geschlossene Blumentülle 8 mm |

853 Boquilla redonda de policarbonato / Polycarbonate plain tube / Douille unie en polycarbonate / Rundtülle Polycarbonat



REF	Ø mm	Num.	€	U
853.004	4	0	2,00	1
853.006	6	2	2,00	1
853.008	8	4	2,00	1
853.010	10	6	2,00	1
853.012	12	8	2,00	1
853.014	14	10	2,00	1
853.016	16	12	2,00	1

854 Boquilla estrella de policarbonato / Polycarbonate star tube / Douille cannelée en polycarbonate / Sterntülle Polycarbonat



REF	Ø mm	Nº PUNTAS / Nº TEETH / Nº DENTS / Nº ZACKEN	Num.	€	U
854.006	6	7	2	2,00	1
854.008	8	7	4	2,00	1
854.010	10	7	6	2,00	1
854.012	12	7	8	2,00	1
854.014	14	8	10	2,00	1
854.016	16	8	12	2,00	1

855 Conjunto de 6 boquillas de policarbonato nº 5 / Set of 6 polycarbonate tubes nº 5 / Boîte de 6 douilles en polycarbonate nº 5 / Set von 6 Tüllen Polycarbonat Nr. 5

Boquilla redonda
Plain tube
Douille unie
Rundtülle



REF	€	U
855.000	12,25	1

Nº 0 4 mm Nº 2 6 mm Nº 4 8 mm Nº 6 10 mm Nº 8 12 mm Nº 10 14 mm



856 Conjunto de 6 boquillas de policarbonato nº 6 / Set of 6 polycarbonate tubes nº 6 / Boîte de 6 douilles en polycarbonate nº 6 / Set von 6 Tüllen Polycarbonat Nr. 6

Boquilla estrella
Star tube
Douille cannelée
Sterntülle



REF	€	U
856.000	12,25	1

Nº 2 6 mm Nº 4 8 mm Nº 6 10 mm Nº 8 12 mm Nº 10 14 mm Nº 12 16 mm



857 Conjunto de 12 boquillas de policarbonato nº 12 / Set of 12 polycarbonate tubes nº 12 / Boîte de 12 douilles en polycarbonate nº 12 / Set von 12 Tüllen Polycarbonat Nr. 12

Boquilla redonda
Plain tube
Douille unie
Rundtülle



REF	€	U
857.000	24,50	1

Boquilla estrella
Star tube
Douille cannelée
Sterntülle

Nº 2 6 mm Nº 4 8 mm Nº 6 10 mm Nº 8 12 mm Nº 10 14 mm Nº 12 16 mm Nº 0 4 mm Nº 2 6 mm Nº 4 8 mm Nº 6 10 mm Nº 8 12 mm Nº 10 14 mm





MEDIDAS /
SIZES /
MESURES /
GRÖSSEN

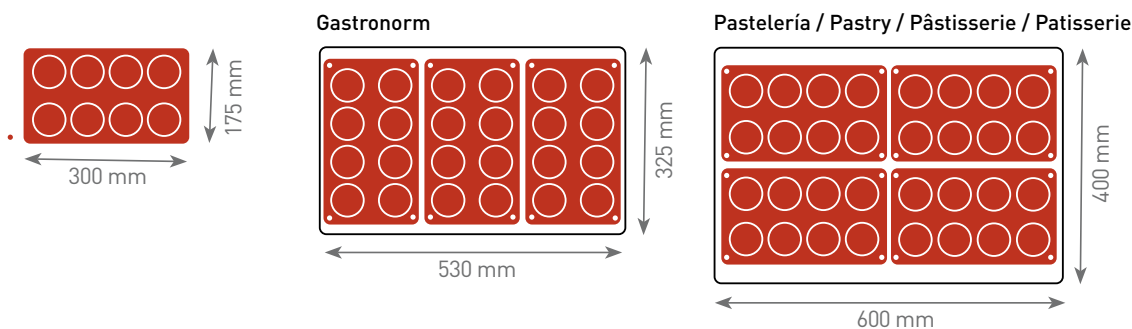

ESPAÑOL

CARACTERÍSTICAS TÉCNICAS

FABRICADO EN SILICONA 100% APTA PARA USO ALIMENTARIO SEGÚN LAS NORMAS INTERNACIONALES HACCP. ESTOS MOLDES SON ANTIADHERENTES POR LO QUE NO ES NECESARIO ENGRASARLOS ANTES. SU FLEXIBILIDAD PERMITE UN RÁPIDO Y FÁCIL DESMOLDE. FÁCIL DE LIMPIAR CON SOLO AGUA CALIENTE Y UNA SUAVE ESPONJA O EN EL LAVAVAJILLAS. MÍNIMO MANTENIMIENTO, MÁXIMA RESISTENCIA Y LARGA DURACIÓN.

UTILIZACIÓN

RESISTENTE A TEMPERATURAS DE -60 °C A +230 °C. IDEAL PARA CONGELADOR Y HORNO. PUEDE SER UTILIZADO PARA PREPARAR TODO TIPO DE PEQUEÑA REPOSTERÍA, GALLETAS O CHOCOLATES.

ENGLISH

TECHNICAL SPECIFICATIONS

MANUFACTURED IN PLAIN 100% SILICONE. THE MOULDS ARE SUITABLE FOR FOOD CONTACT AS PER INTERNATIONAL REGULATIONS H.A.C.C.P. THE SURFACE IS NON-STICK SO IT IS NOT NECESSARY TO GREASE IT BEFORE USE. THE FLEXIBILITY OF THE MOULDS GUARANTEES A QUICK AND EASY REMOVAL. THE MOULDS ARE EASY TO CLEAN WITH HOT WATER AND SOFT SPONGE. SAFE DISHWASHER. MINIMUM MAINTENANCE, LONG DURABILITY AND MAXIMUM RESISTANCE.

UTILISATION

THE RESISTANCE OF THE MOULDS TO EXTREME TEMPERATURES FROM -60 °C TO +230 °C MAKES THEM IDEAL FOR FREEZING OR FOR BAKING. IT CAN ALSO BE USED FOR ALL PREPARATIONS OF CAKES, CHOCOLATES, PETIT-FOURS, AND CATERING PREPARATIONS.

FRANÇAIS

CARACTERISTIQUES TECHNIQUES

FABRICATION 100% SILICONE ALIMENTAIRE. CES MOULES SONT CONFORMES AU CONTACT ALIMENTAIRE SELON LES NORMES INTERNATIONALES H.A.C.C.P. CES MOULES SONT ANTI-ADHÉSIFS ET NE NÉCESSITENT PAS DE GRAISSAGE AVANT UTILISATION. LA FLEXIBILITÉ DES MOULES GARANTIT UN RAPIDE ET FACILE DEMOULAGE. LAVABLE EN MACHINE À LAVER OU AVEC UNE ÉPONGE À L'EAU. MINIMUM D'ENTRETIEN, LONGUE DURABILITÉ ET MAXIMUM DE RESISTANCE.

UTILISATION

RÉSISTANT À DES TEMPÉRATURES DE -60 °C À +230 °C. IDÉAL POUR LA CONGÉLATION OU CUISSONS AU FOUR. UTILISABLE POUR TOUT TYPE DE PRÉPARATIONS DE CAKES, CHOCOLATS, PETITS FOURS, ET PRÉPARATIONS TRAITEURS.

DEUTSCH

TECHNISCHE EIGENSCHAFTEN

HERGESTELLT AUS 100% SILIKON GEEIGNET FÜR DIE LEBENSMITTELVERARBEITUNG ENTSPRECHEND DER INTERNATIONALEN NORMEN HACCP. DIESE FORMEN SIND ANTIHAFTEND UND MAN BENÖTIGT KEIN VORHERIGES EINFETTEN. SEINE FLEXIBILITÄT ERLAUBT EINE EINFACHE UND SCHNELLE ABLÖSUNG VON DER FORM. EINFACHE REINIGUNG NUR MIT WARMEN WASSER UND EINEM WEICHEN SCHWAMM ODER IN DER SPÜLMASCHINE. MINIMALE INSTANDHALTUNG, MAXIMALE RESISTENZ UND LANGLEBIGKEIT.

GEBRAUCH

RESISTENT GEGEN TEMPERATUREN VON -60 °C BIS +230 °C. IDEAL FÜR DEN GEFRIERSCHRANK UND DEN OFEN. SIE SIND GEEIGNET FÜR ALLE ARTEN DER ZUBEREITUNG VON KLEINEN NACHSPEISEN, KEKSEN ODER SCHOKOLADEN.

● - 60 °C / - 140 °F
● + 230 °C / + 446 °F



H.A.C.C.P.
NO PROBLEM

MEDIA BOLA

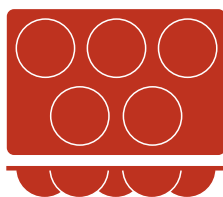

REF	Fig	Ø mm	H mm	€
850.001	5	80	40	13,80

MEDIA BOLA

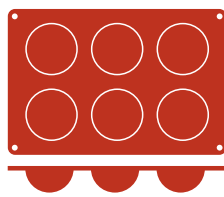

REF	Fig	Ø mm	H mm	€
850.002	6	70	35	13,80

MEDIA BOLA

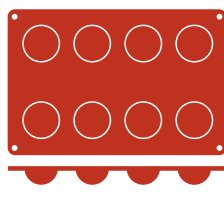

REF	Fig	Ø mm	H mm	€
850.003	8	60	30	13,80

MEDIA BOLA

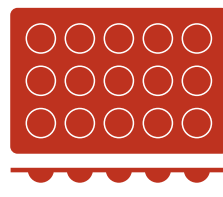

REF	Fig	Ø mm	H mm	€
850.004	15	50	25	13,80

MEDIA BOLA

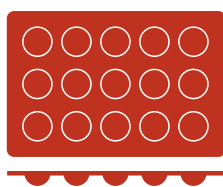

REF	Fig	Ø mm	H mm	€
850.005	15	40	20	13,80

MEDIA BOLA

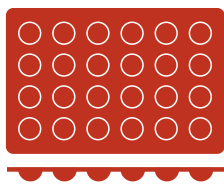

REF	Fig	Ø mm	H mm	€
850.006	24	30	15	13,80

PIRAMIDE



REF	Fig	mm	H mm	€
850.007	6	71 x 71	40	13,80

PIRAMIDE

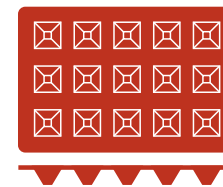

REF	Fig	mm	H mm	€
850.008	15	36 x 36	22	13,80

POMPONETTE

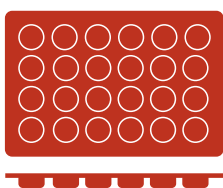

REF	Fig	Ø mm	H mm	€
850.009	24	34	16	13,80

MINI-SAVARIN

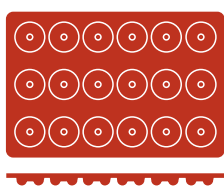

REF	Fig	Ø mm	H mm	€
850.010	18	41	12	13,80

SAVARIN



REF	Fig	Ø mm	H mm	€
850.011	8	65	21	13,80

SAVARIN

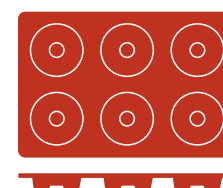

REF	Fig	Ø mm	H mm	€
850.012	6	72	23	13,80

MINI-TARLETA

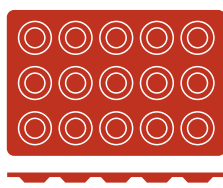

REF	Fig	Ø mm	H mm	€
850.013	15	45	10	13,80

TARLETA

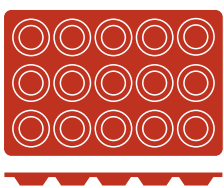

REF	Fig	Ø mm	H mm	€
850.014	15	50	15	13,80

TARLETA

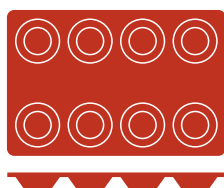

REF	Fig	Ø mm	H mm	€
850.015	8	60	17	13,80

TARLETA

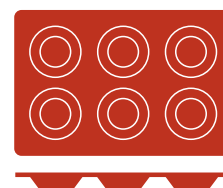

REF	Fig	Ø mm	H mm	€
850.016	6	70	20	13,80

OVAL

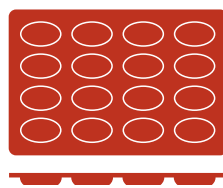

REF	Fig	mm	H mm	€
850.017	16	53 x 33	20	13,80

OVAL

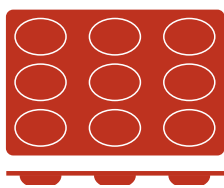

REF	Fig	mm	H mm	€
850.018	9	70 x 50	20	13,80

MINI-BABA



REF	Fig	Ø mm	H mm	€
850.019	15	35	38	13,80

MEDIO-BABA



REF	Fig	Ø mm	H mm	€
850.020	11	45	48	13,80

GRANDE-BABA

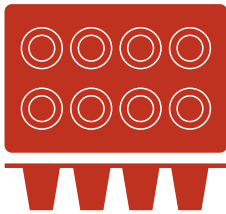

REF	Fig	Ø	H	€
		mm	mm	
850.021	8	55	60	13,80

MUFFIN

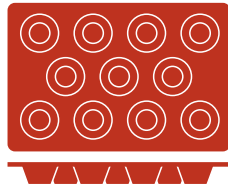

REF	Fig	Ø	H	€
		mm	mm	
850.022	11	50	28	13,80

MUFFIN

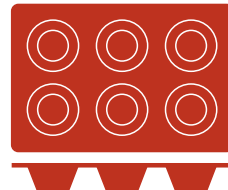

REF	Fig	Ø	H	€
		mm	mm	
850.023	6	70	37	13,80

MUFFIN

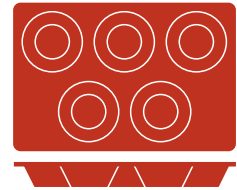

REF	Fig	Ø	H	€
		mm	mm	
850.024	5	80	35	13,80

CAKE

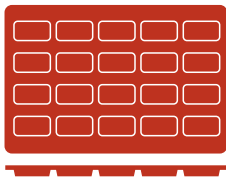

REF	Fig	mm	H	€
			mm	
850.025	20	49 x 26	11	13,80

CAKE

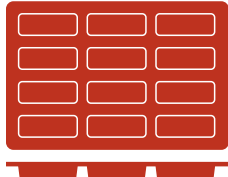

REF	Fig	mm	H	€
			mm	
850.026	12	80 x 30	30	13,80

PETIT FOUR

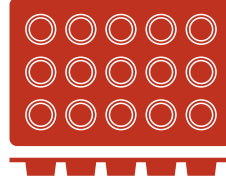

REF	Fig	Ø	H	€
		mm	mm	
850.027	15	40	20	13,80

CILINDRO



REF	Fig	Ø	H	€
		mm	mm	
850.028	8	60	35	13,80

FLORENTINO

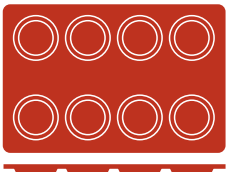

REF	Fig	Ø	H	€
		mm	mm	
850.029	8	60	12	13,80

FLORENTINO

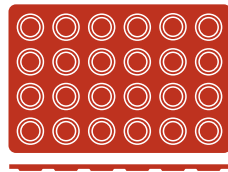

REF	Fig	Ø	H	€
		mm	mm	
850.030	24	35	5	13,80

MADALENA

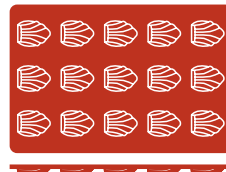

REF	Fig	mm	H	€
			mm	
850.031	15	65 x 32	10	13,80

MADALENA



REF	Fig	mm	H	€
			mm	
850.032	9	78 x 45	17	13,80

BORDELAIS

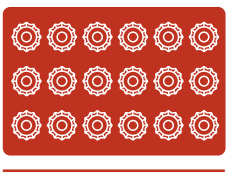

REF	Fig	Ø	H	€
		mm	mm	
850.033	18	35	35	13,80

BRIOCHE

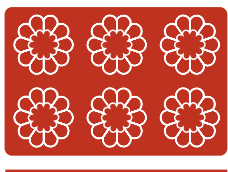

REF	Fig	Ø	H	€
		mm	mm	
850.034	6	79	37	13,80

BRIOCHE

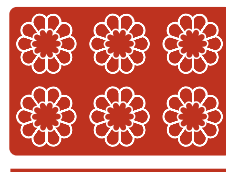

REF	Fig	Ø	H	€
		mm	mm	
850.035	6	79	30	13,80

CORAZON

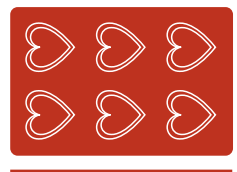

REF	Fig	mm	H	€
			mm	
850.036	6	50 x 50	35	13,80

CORAZON



REF	Fig	mm	H	€
			mm	
850.037	8	65 x 60	35	13,80

BARQUETA

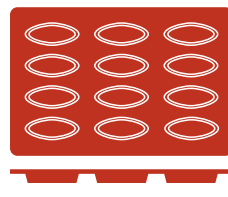

REF	Fig	mm	H	€
			mm	
850.038	12	72 x 30	15	13,80

BARQUETA

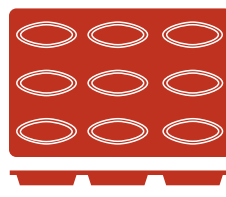

REF	Fig	mm	H	€
			mm	
850.039	9	100 x 44	15	13,80

OCTOGONO

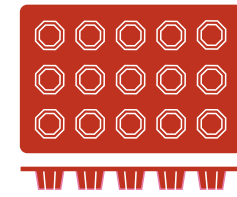

REF	Fig	Ø	H	€
		mm	mm	
850.040	15	38	26	13,80

8504 Molde cake / Cake mould / Moule à cake / Kuchenbackform



REF	cm	€	U
850.424	24 x 10,5 x 6,5	18,95	1
850.426	26 x 10 x 7	19,65	1

8501 Molde tarta / High cake mould / Manqué rond uni / Tortenbackform



REF	Ø cm	H cm	€	U
850.124	24	4,2	18,95	1
850.128	28	4,7	20,55	1

8503 Molde savarin bajo / Low savarin mould / Moule savarin bas / Flache Savarinbackform



REF	Ø cm	H cm	€	U
850.324	24	6,0	18,95	1

8502 Molde savarin alto / Gugelhoph / Moule savarin haut / Hohe Savarinbackform



REF	Ø cm	H cm	€	U
850.222	22,5	11,5	20,35	1

Nueva forma
New shape
Nouvelle forme
Neue Form

8505 Molde rizado para tarta / Round tart mould with fluted edges / Tourtière ronde avec bord cannelé / Tortenbackform mit runden Ecken



REF	Ø cm	H cm	€	U
850.524	24	3,0	17,00	1
850.528	28	3,0	20,05	1

Nueva forma
New shape
Nouvelle forme
Neue Form

8506 Flanero rizado / Brioche mould / Moule à brioche / Briochebackform



REF	Ø cm	H cm	€	U
850.614	14	5,0	20,05	1

Nueva gama de moldes especiales para chocolate. Fabricados en silicona 100% /
 New range of chocolate moulds. Made of 100% silicone /
 Nouvelle gamme de moules spéciaux pour chocolat. Fabriqués en silicone 100% /
 Neue Produktreihe speziell für Schokolade. Hergestellt aus 100% Silikon

- 60 °C
 + 260 °C



850801 Molde chocolate flor / Flower chocolate mould / Moule chocolat fleur / Schokoladenform Blume



REF	cm	H mm	Fig	€	U
850.801	18 x 18	5,0	12	8,75	1

850803 Molde chocolate arbol / Tree chocolate mould / Moule chocolat arbre / Schokoladenform Baum



REF	cm	H mm	Fig	€	U
850.803	18 x 18	5,0	12	8,75	1

850804 Molde chocolate corazón / Heart chocolate mould / Moule chocolat coeur / Schokoladenform Herz



REF	cm	H mm	Fig	€	U
850.804	18 x 18	5,0	12	8,75	1

850805 Molde chocolate números / Number chocolate mould / Moule chocolat numéro / Schokoladenform Nummern



REF	Ø cm	H mm	Fig	€	U
850.805	20	20,0	10	8,75	1

Moldes de silicona 600 x 400 mm Ofrecen la posibilidad de dividirlos en 2 moldes de 300 x 200 mm gracias a su diseño simétrico /
Silicone moulds 600 x 400 mm. Possible to divide in two of 300 x 200 mm thanks to its symmetrical design /
Moules en silicone 600 x 400 mm avec possibilité de diviser en deux moules de 300 x 200 mm grâce à sa symétrie /
Silikonformen 600 x 400 mm. Dank seinem symmetrischen Design können sie in zwei Formen von 300 x 200 mm geteilt werden.

859900 Mini-cakes / Mini-cakes / Mini-cakes / Minikuchen

REF	Fig	mm	H mm	€	U
859.900	20	80 x 30	30	77,15	1

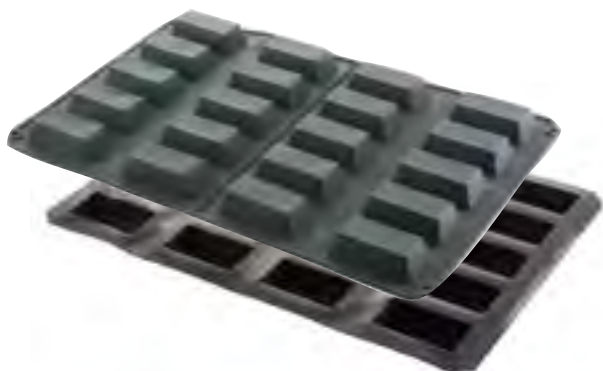

600 x 400 mm

859901 Briochette

REF	Fig	Ø mm	H mm	€	U
859.901	24	79	37	77,15	1

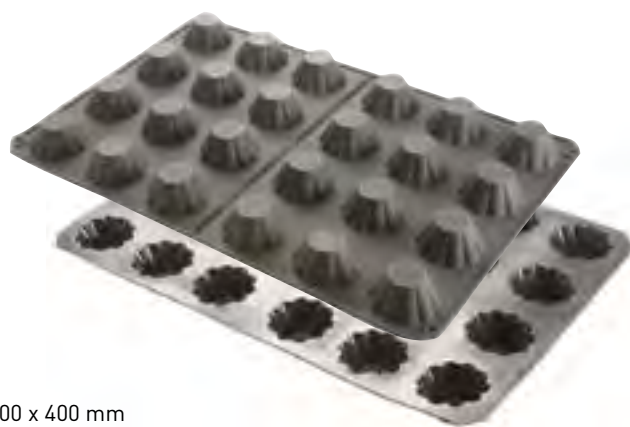

600 x 400 mm

859902 Semi-esferas / Half-spheres / Demi-sphères / Halbkugeln

REF	Fig	Ø mm	H mm	€	U
859.902	24	70	35	77,15	1



600 x 400 mm

859903 Muffin

REF	Fig	Ø mm	H mm	€	U
859.903	24	70	42	77,15	1



600 x 400 mm

859904 Mini muffin

REF	Fig	Ø mm	H mm	€	U
859.904	70	50	28	77,15	1



600 x 400 mm

859905 Gugelhopf

REF	Fig	Ø mm	H mm	€	U
859.905	24	70	36	77,15	1



600 x 400 mm

859906 Savarin

REF	Fig	Ø mm	H mm	€	U
859.906	24	72	23	77,15	1



600 x 400 mm

859907 Mini madalenas / Mini madeleines / Mini madeleines / Minimadeleines

REF	Fig	mm	H mm	€	U
859.907	84	42 x 30	11	77,15	1



600 x 400 mm

859908 Tartaletas / Tartalets /
Tartalettes / Törtchen

REF	Fig	Ø mm	H mm	€	U
859.908	60	50	15	77,15	1



600 x 400 mm

859909 Canalados / Cannelés

REF	Fig	Ø mm	H mm	€	U
859.909	60	85	50	77,15	1



600 x 400 mm

859910 Piramides / Pyramids /
Pyramides / Pyramiden

REF	Fig	mm	H mm	€	U
859.910	30	71 x 71	40	77,15	1

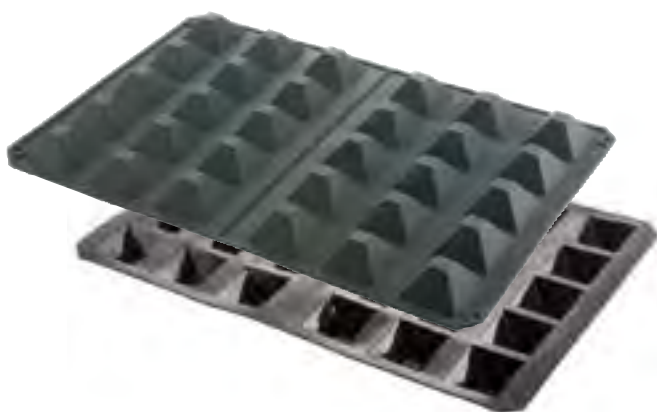

600 x 400 mm

859911 Florentinas / Florentiners /
Florentins / Florentiner

REF	Fig	Ø mm	H mm	€	U
859.911	40	35	12	77,15	1



600 x 400 mm



ESPAÑOL

EL FLEXIPAN® ES UNA COMBINACIÓN DE FIBRAS DE VIDRIO Y SILICONA ADECUADAS PARA EL USO ALIMENTARIO. ESTA COMBINACIÓN DE MATERIALES LE DA A LA PIEZA UNA SOLIDEZ Y DURACIÓN DE VIDA INIGUALABLES, ASI COMO PROPIEDADES ANTI-ADHERENTES EXCEPCIONALES TANTO EN COCCIÓN COMO EN CONGELACIÓN. EL FLEXIPAN® NO REQUIERE SER ENGRASADO YA QUE SU COMPOSICIÓN Y FLEXIBILIDAD PERMITEN UN DESMOLDEO FÁCIL Y RÁPIDO. EL FLEXIPAN® CON UN USO Y TRATO CORRECTOS NOS PERMITE REALIZAR ENTRE 2.000 Y 3.000 COCCIONES ANTES DE EMPEZAR A NOTAR LOS PRIMEROS SIGNOS DE DETERIORO. EL FLEXIPAN® PERMITE REALIZAR CUALQUIER TIPO DE PREPARACIONES DULCES O SALADAS, TANTO EN COCCIÓN (+280°C) COMO EN CONGELACIÓN (-40°C).

VENTAJAS FLEXIPAN®

- NO ES NECESARIO ENGRASAR LOS MOLDES PARA OBTENER UN DESMOLDEO PERFECTO
- GRAN FACILIDAD PARA EL DESMOLDEO DE PIEZAS CONGELADAS
- LA LIMPIEZA DE LOS MOLDES SE REALIZA DE UNA MANERA FÁCIL Y RÁPIDA
- LARGA VIDA DE LA PIEZA (2.000-3.000) COCCIONES
- MEDIDAS PARA PASTELERÍA PROFESIONAL (60x40 CM)
- GAMA COMPLETA DE FORMAS

ENGLISH

THE FLEXIPAN® IS A SILICONE AND FIBRE GLASS COMBINATION MOULD SUITABLE FOR THE FOOD CONTACT. THIS MATERIAL COMBINATION GIVES TO THE PIECE SOLIDITY AND AN EXTRAORDINARY DURABILITY, ALLIED WITH EXCEPTIONAL NON-STICK PROPERTIES EITHER FOR COOKING AND FREEZING. THE FLEXIPAN® DOES NOT REQUIRE TO BE LUBRICATED SINCE THEIR COMPOSITION AND FLEXIBILITY ALLOW AN EASY AND FAST RELEASE FROM THE MOULD. ACCORDING TO THE USE AND THE MAINTENANCE, THE FLEXIPAN®, ENABLE US TO USE THEM BETWEEN 2000 AND 3000 TIMES BEFORE THE FIRST SIGNS OF STICKING ARISE. THE FLEXIPAN CAN BE USED TO BAKE (+280°C) OR FREEZE (-40°C) THE MOST SWEET AND SAVOURY PRODUCTS.

ADVANTAGES FLEXIPAN®

- NO NEED TO BE GREASED FOR AN EASY AND QUICK REALISE
- EASY TO CLEAN
- BETWEEN 2000 AND 3000 TIMES CAN BE USED
- PROFESSIONAL PASTRY MEASURES (60x40 CM)
- LARGE RANGE OF MOULDS

FRANÇAIS

LE FLEXIPAN® EST UNE COMBINAISON DE TISSUES DE VERRE ET SILICONES ADÉQUATS POUR L'UTILISATION ALIMENTAIRE. CETTE COMBINAISON DE MATÉRIELS DONNE AU MOULE UNE SOLIDITÉ ET UNE DURABILITÉ EXTRAORDINAIRE, ALLIÉES À DES PROPRIÉTÉS ANTI-ADHÉRENTES EXCEPTIONNELLES TANT EN CUISSON COMME EN CONGÉLATION. LE FLEXIPAN® N'A PAS BESOIN D'ÊTRE LUBRIFIÉ PUISQUE SA COMPOSITION ET FLEXIBILITÉ PERMETTENT UN DÉMOULAGE FACILE ET RAPIDE. SELON L'UTILISATION ET L'ENTRETIEN DES MOULES, LE FLEXIPAN®, NOUS PERMET D'EFFECTUER ENTRE 2.000 ET 3.000 CUISSONS AVANT DE NOTER LES PREMIERS SIGNES DE COLLAGE. LE FLEXIPAN® PERMET D'EFFECTUER TOUS TYPES DE PRÉPARATIONS SUCRÉES OU SALÉES, EN CUISSON (+ 280°C) OU EN CONGÉLATION (-40°C).

AVANTAGES FLEXIPAN®

- NE PRÉCISE D'AUCUN GRAISSAGE POUR UN DÉMOULAGE FACILE ET RAPIDE
- FACILE À NETTOYER
- DE 2000 À 3000 CUISSONS PAR MOULE
- MESURES POUR LA PÂTISSERIE PROFESSIONNELLE (60x40 CM)
- LARGE GAMME DE MOULES

DEUTSCH

FLEXIPAN® IST EINE KOMBINATION AUS FIBERGLAS UND SILIKON ANGEPAST AN DIE LEBENSMITTELVERARBEITUNG.

DIESE MATERIALKOMBINATION GIBT DER FORM SOWOHL EINE FESTIGKEIT UND EINE UNVERGLEICHLICHE LANGLEBIGKEIT, ALS AUCH ANTIHAFT-EIGENSCHAFTEN WÄHREND DES BACKENS UND DER EINFRIERUNG.

FLEXIPAN® BRAUCHT KEINE EINFETTUNG AUFGRUND SEINER ZUSAMMENSTELLUNG UND ERLAUBT EINE SCHNELLE UND EINFACHE ABLÖSUNG VON DER FORM. FLEXIPAN® BIETET BEI EINEM KORREKTEM GEBRAUCH UND BEHANDLUNG DIE REALISIERUNG ZWISCHEN 2.000 UND 3.000 BACKUNGEN BEVOR MAN DIE ERSTEN VERSCHLEISSERSCHINUNGEN BEMERKT.

FLEXIPAN® ELAUBT DIE REALISIERUNG ALLER ARTEN DER ZUBEREITUNG VON NACHSPEISEN SOWOHL BEIM BACKEN (+280°C) ALS AUCH BEIM EINFRIEREN (-40°C).

VORTEILE FLEXIPAN®

- KEINE EINFETTUNG NÖTIG UM EIN PERFEKTES ABLÖSEN VON DER FORM ZU ERREICHEN
- EINFACHSTE ABLÖSUNG DER EINGEFRORENEN STÜCKE VON DER FORM
- EINFACHE UND SCHNELLE REINIGUNG DER FORMEN
- LANGLEBIGKEIT DER FORMEN (2.000-3.000) BACKUNGEN
- GRÖSSE FÜR DIE PROFESSIONELLE PATISSERIE (60x40 CM)
- GROSSE PRODUKTVIELFALT

Pastelería / Pastry /
Pâtisserie / Pâtisserie

Medidas
Sizes
Mesures
Grösse

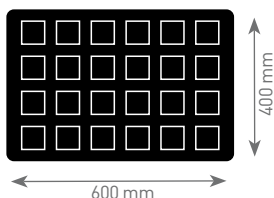

- 40 °C / - 104 °F
+ 280 °C / + 539 °F



H.A.C.C.P.
NO PROBLEM

CONOS / CONES /
CONES / KEGEL

REF	Forma	Fig	Ø mm	H mm	ml	€	U
859.133		96	30	20,0	6	153,25	1
859.134		40	50	40,0	24	153,25	1
859.135		20	70	60,0	80	153,25	1

ZAFIRO / SAPHIRS /
SAPHIRS / SAPHIRE

REF	Forma	Fig	mm	H mm	ml	€	U
859.136		96	40 x 40	24,0	17	153,25	1
859.137		40	70 x 70	35,0	75	153,25	1
859.138*		20	70 x 70	32,0	80	153,25	1

* Savarin Záfiro

BAVAROIS / ROSACE SHAPE /
BAVAROIS / BAYERISCH

REF	Forma	Fig	Ø mm	H mm	ml	€	U
859.139		18	78	35,0	100	153,25	1



CHARLOTTE



REF	Forma	Fig	Ø mm	H mm	ml	€	U
859.140		60	35	15,0	9	153,25	1
859.141		24	62	35,0	60	153,25	1
859.113		18	78	40,0	100	153,25	1

MAGDALENAS / MADELEINES /
MADELEINES / MADELEINES

REF	Forma	Fig	mm	H mm	ml	€	U
859.142		56	52 x 33	15,0	15	153,25	1
859.115		40	78 x 47	19,0	35	153,25	1

CONCHAS / SAINT JACQUES SHELL /
COQUILLES SAINT-JACQUES / JAKOBSMUSCHELN

REF	Forma	Fig	mm	H mm	ml	€	U
859.132		24	80 x 75	20,0	70	153,25	1



MARGARITAS / DEEP FLOWER /
MARGUERITES EN RELIEF / MAGERITEN



REF	Forma	Fig	Ø mm	H mm	ml	€	U
859.143		24	70	27,0	70	153,25	1



FLORES / FLOWERS /
FLEURS / BLUMEN



REF	Forma	Fig	Ø mm	H mm	ml	€	U
859.144		24	78	20,0	80	153,25	1



CORAZONES / HEARTS /
COEURS / HERZEN



REF	Forma	Fig	mm	H mm	ml	€	U
859.145		70	41 x 38	16,0	15	153,25	1
859.146		20	75 x 65	35,0	81	153,25	1
859.147		8	120 x 113	35,0	200	153,25	1
859.148		20	66 x 62	25,0	55	153,25	1
859.131		20	66 x 62	35,0	90	153,25	1
859.149		24	64 x 64	26,0	65	153,25	1



PIRÁMIDES / PYRAMIDS /
PYRAMIDES / PYRAMIDEN



REF	Forma	Fig	mm	H mm	ml	€	U
859.109		54	35 x 35	23,0	15	153,25	1
859.111		35	50 x 50	35,0	35	153,25	1
859.110		24	71 x 71	41,0	90	153,25	1



SEMI-ESFERAS / HALF-SPHERES /
DEMI-SPHÈRES / HALBKUGELN

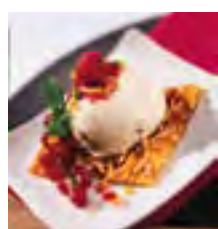

REF	Forma	Fig	Ø mm	H mm	ml	€	U
859.151		96	26	16,0	6	153,25	1
859.105		70	29	18,0	10	153,25	1
859.103		48	42	21,0	20	153,25	1
859.102		28	58	31,0	50	153,25	1
859.101		24	70	40,0	105	153,25	1
859.104		24	80	40,0	126	153,25	1



SEMI-ESFERAS INVERTIDAS / HALF-SPHERES UPSIDE DOWN /
DEMI-SPHÈRES INVERSÉES / UMGEKEHRTE HALBKUGELN



REF	Forma	Fig	Ø mm	H mm	ml	€	U
859.150		45	26	16,0	6	153,25	1



CUADRADOS / SQUARES /
CARRÉS / QUADRATE

REF	Forma	Fig	mm	H mm	ml	€	U
859.152		60	37 x 37	17,0	18	153,25	1
859.153		35	56 x 56	24,0	60	153,25	1

TARDALETAS CUADRADAS / SQUARE TARTLET /
TARTELETTES CARRÉES / QUADRATISCHE TÖRTCHEN

REF	Forma	Fig	mm	H mm	ml	€	U
859.154		60	45 x 45	12,0	20	153,25	1
859.155		40	60 x 60	15,0	40	153,25	1

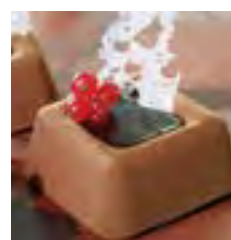
SAVARINS CUADRADAS / SQUARE SAVARINS /
SAVARINS CARRÉES / QUADRATISCHE SAVARINE

REF	Forma	Fig	mm	H mm	ml	€	U
859.156		60	37 x 37	17,0	15	153,25	1
859.157		35	56 x 56	24,0	45	153,25	1
859.158		24	70 x 70	30,0	100	153,25	1

SAVARINS REDONDOS / ROUND SAVARINS /
SAVARINS RONDS / RUNDE SAVARINE

REF	Forma	Fig	Ø mm	H mm	ml	€	U
859.159		60	41	12,0	10	153,25	1
859.124		35	66	20,0	50	153,25	1
859.219		24	70	23,0	65	153,25	1
859.122		24	80	20,0	70	153,25	1

SAVARINS OVALADOS / OVAL SAVARINS /
SAVARINS OVALES / OVALE SAVARINE

REF	Forma	Fig	mm	H mm	ml	€	U
859.160		60	40 x 30	12,0	9	153,25	1
859.161		30	70 x 50	22,0	48	153,25	1
859.123		24	80 x 60	25,0	70	153,25	1

QUENELLES / QUENELLES /
QUENELLES / QUENELLES

REF	Forma	Fig	mm	H mm	ml	€	U
859.162		100	42 x 22	17,0	5	153,25	1
859.163		72	42 x 26	20,0	5,6	153,25	1
859.164		64	57 x 35	12,0	18	153,25	1
859.165		42	60 x 40	25,0	30	153,25	1



ÓVALOS / OVAL /
OVALES / OVALE



REF	Forma	Fig	mm	H mm	ml	€	U
859.166		50	51 x 31	20,0	20	153,25	1
859.167		30	70 x 50	30,0	75	153,25	1
859.130		30	85 x 60	30,0	100	153,25	1
859.168		24	96 x 45	28,0	80	153,25	1



TARLETAS OVALADAS / OVAL TARTLETS /
TARLETTES OVALES / OVALE TÖRTCHEN



REF	Forma	Fig	mm	H mm	ml	€	U
859.169		48	66 x 27	11,0	10	153,25	1
859.127		30	106 x 45	15,0	35	153,25	1



MINI TARLETAS ACANALADAS / MINI FLUTED TARTLETS /
TARLETTES CANNELÉES / TÖRTCHEN MIT RUNDEN ECKEN



REF	Forma	Fig	mm	H mm	ml	€	U
859.170		40	46 x 38	15,0	11	153,25	1



TARLETAS REDONDAS / ROUND TARTLETS /
TARLETTES RONDS / RUNDE TÖRTCHEN



REF	Forma	Fig	Ø mm	H mm	ml	€	U
859.114		60	42	10,0	13	153,25	1
859.171		48	48	15,0	20	153,25	1
859.172		40	58	20,0	35	153,25	1
859.126		24	77	20,0	65	153,25	1
859.173		15	96	25,0	135	153,25	1



TRONCOS / LOGS /
BÛCHE / BLÖCKE



REF	Forma	Fig	mm	H mm	ml	€	U
859.125		24	95 x 40	30,0	80	153,25	1
859.183		24	122 x 42	32,0	115	153,25	1
859.184		8	339 x 40	39,0	450	153,25	1
859.185		5	495 x 40	39,0	700	153,25	1



CAKES/BIZCOCHOS / CAKES-LADY FINGERS /
CAKES-COUDOIRS / KUCHEN/ BISKUIT



REF	Forma	Fig	mm	H mm	ml	€	U
859.186		120	40 x 15	12,0	6	153,25	1
859.187		24	120 x 40	25,0	100	153,25	1
859.188		45	109 x 24	10,0	20	153,25	1



LINGOTES / LINGOTS /
LINGOTS / BARREN

REF	Forma	Fig	mm	H mm	ml	€	U
859.189		24	100 x 40	25,0	70	153,25	1
859.190		24	120 x 40	25,0	90	153,25	1

SEMI-CILINDROS / HALF-CYLINDRES /
DEMI-CYLINDRES / HALBZYLINDER

REF	Forma	Fig	mm	H mm	ml	€	U
859.191		48	85 x 17	15,0	20	153,25	1



CAKES



REF	Forma	Fig	mm	H mm	ml	€	U
859.192		24	80 x 30	30,0	55	153,25	1
859.193		25	89 x 46	25,0	110	153,25	1
859.194		18	102 x 58	30,0	139	153,25	1
859.195		16	110 x 60	25,0	105	153,25	1



FINANCIERS



REF	Forma	Fig	mm	H mm	ml	€	U
859.196		84	50 x 26	11,0	10	153,25	1
859.197		24	86 x 46	14,0	45	153,25	1



MUFFINS



REF	Forma	Fig	Ø mm	H mm	ml	€	U
859.106		40	51	29,0	45	153,25	1
859.107		24	73	40,0	125	153,25	1
859.108		24	79	36,0	115	153,25	1
859.198		15	82	50,0	220	153,25	1
859.199		15	91	35,0	190	153,25	1



DARIOLES



REF	Forma	Fig	Ø mm	H mm	ml	€	U
859.118		15	65	55,0	128	153,25	1



ESTRELLAS / STARS /
ÉTOILES / STERNE



REF	Forma	Fig	mm	H mm	ml	€	U
859.181		24	70 x 45	20,0	45	153,25	1
859.182		24	80 x 65	15,0	35	153,25	1



CILINDROS / CYLINDERS /
CYLINDRES / ZYLINDER



REF	Forma	Fig	Ø mm	H mm	ml	€	U
859.206		48	40	20,0	25	153,25	1
859.207		24	63	25,0	65	153,25	1
859.117		24	63	35,0	90	153,25	1



FLORENTINA / FLORENTINERS /
FLORENTINS / FLORENTINER



REF	Forma	Fig	Ø mm	H mm	ml	€	U
859.208		40	50	13,0	30	153,25	1
859.129		15	102	20,0	140	153,25	1



COOKIES / COOKIES /
COOKIES / COOKIES



REF	Forma	Fig	Ø mm	H mm	ml	€	U
859.128		24	78	10,0	50	153,25	1
859.209		15	91	8,0	60	153,25	1



TARTAS TATIN / ETATIN APPLE TARTS /
TARTES TATIN / TATINTORTEN



REF	Forma	Fig	Ø mm	H mm	ml	€	U
859.210		15	82	30,0	135	153,25	1
859.211		12	100	35,0	245	153,25	1
859.212		12	105	40,0	305	153,25	1



ENTREMETS-PIZZAS-QUICHES / ROUND-PIZZA-QUICHES /
EMPREINTES RONDAS-PIZZA-QUICHES / VORSPEISE-PIZZA-QUICHES



REF	Forma	Fig	Ø mm	H mm	ml	€	U
859.213		11	125	16,0	75	153,25	1
859.214		6	140	25,0	360	153,25	1
859.215		6	147	12,0	200	153,25	1
859.216		6	150	15,0	250	153,25	1
859.217		6	150	24,0	390	153,25	1
859.218		6	166	12,0	240	153,25	1
859.116		6	186	12,0	300	153,25	1



CUCHARAS / SPOONS /
CUILLÈRES / LÖFFEL



REF	Forma	Fig	mm	H mm	ml	€	U
859.174		36	90 x 28	12,0	15	153,25	1



LANZADERAS / MINI-BRIOCHES /
NAVETTES / SCHIFFCHEN

REF	Forma	Fig	mm	H mm	ml	€	U
859.200		48	70 x 30	10,0	15	153,25	1

ALARGADAS / LONG /
LONGUES / LANGE

REF	Forma	Fig	mm	H mm	ml	€	U
859.201		24	130 x 48	18,0	80	153,25	1

REDONDAS / ROUNDS /
RONDS / RUNDE

REF	Forma	Fig	Ø mm	H mm	ml	€	U
859.202		24	79	15,0	65	153,25	1

FLORES / FLOWERS /
FLEURS / BLUMEN

REF	Forma	Fig	mm	H mm	ml	€	U
859.203		24	62 x 49	26,0	60	153,25	1

ACANALDA / CANNELÉES /
CANNELÉES / RUNDE ECKEN

REF	Forma	Fig	Ø mm	H mm	ml	€	U
859.204		24	68	25,0	60	153,25	1
859.205		24	78	30,0	105	153,25	1
859.112		24	81	37,0	105	153,25	1



MINI-GOTA / MINI DROP /
MINI GOUTTES / MINITROPFEN



REF	Forma	Fig	mm	H mm	ml	€	U
859.175		56	52 x 32	20,0	18	153,25	1



TRIÁNGULOS / TRIANGLES /
TRIANGLES / DREIECKE



REF	Forma	Fig	mm	H mm	ml	€	U
859.176		80	48 x 41	10,0	7	153,25	1



ROMBOS / RHOMBUS /
LOSANGE / RHOMBUS

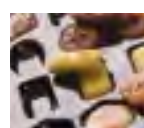

REF	Forma	Fig	mm	H mm	ml	€	U
859.177		70	60 x 35	10,0	9	153,25	1



OCTÁGONOS / OCTAGONS /
OCTAGONES / ACHTECKE



REF	Forma	Fig	mm	H mm	ml	€	U
859.119		40	43 x 40	26,0	28	153,25	1



HEXÁGONOS / HEXAGONES /
HEXAGONES / SECHSECKE



REF	Forma	Fig	mm	H mm	ml	€	U
859.178		45	45 x 40	12,0	12	153,25	1



MEDALLONES / MEDAILLONS /
MÉDAILLONS / MEDAILLEN



REF	Forma	Fig	Ø mm	H mm	ml	€	U
859.179		96	28	8,0	5	153,25	1



MINI-CILÍNDROS / MINI-CYLINDERS /
MINI-CYLINDRES / MINIZYLINDER



REF	Forma	Fig	Ø mm	H mm	ml	€	U
859.180		54	38	10,0	14	153,25	1



POMPONNETTES / POMPONNETTES /
POMPONNETTES / POMPONNETTES

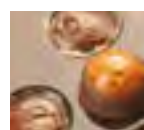

REF	Forma	Fig	Ø mm	H mm	ml	€	U
859.120		96	36	17,0	14	153,25	1



POMPONNETTES / POMPONNETTES /
POMPONNETTES / POMPONNETTES



REF	Forma	Fig	Ø mm	H mm	ml	€	U
859.121		54	40	20,0	22	153,25	1



RECAMBIOS / SPARE PARTS / PIÈCES DE RECHANGE / ERSATZTEILE



142.000

ASADOR GRILL MANGO MADERA / GRILL WOODEN HANDLE /
GRILL QUEUE EN BOIS / PFANNENHOLZGRIF

REF	DESCRIPCIÓN	DESCRIPTION	DESCRIPTION	BESCHREIBUNG
RE142000	MANGO MADERA	WOODEN HANDLE	QUEUE EN BOIS	HOLZGRIFF



15000

FREIDORA / FRYER /
FRITEUSE / FRITEUSSE

REF	DESCRIPCIÓN	DESCRIPTION	DESCRIPTION	BESCHREIBUNG
RE15000	CESTA MALLA	MESH BASKET	PANIER À MAILLES	MASCHENKORB
RE150001	RESISTENCIA	ELEMENT	RÉSISTANCE	HEIZELEMENT
RE1500010	CABEZAL	COMPLETE HEAD	TÊTE COMPLÈTE	KOMPLETTER KOPF
RE1500011	TAPÓN + ARANDELA CABLE	CAP + WASHER FOR	EMBOUT + RONDELLE DE	STÖPSEL + DICHTUNGSRING FÜR
	TERMOSTATO	THERMOSTAT CABLE	CABLE DE THERMOSTAT	THERMOSTATKABEL
RE150003	TERMOSTATO	THERMOSTAT	THERMOSTAT	THERMOSTAT
RE150004	TERMOSTATO DE SEGURIDAD	SECURITY THERMOSTAT	THERMOSTAT DE SÉCURITÉ	SICHERHEITSTHERMOSTAT
RE150005	MANDO THERMOSTATO	THERMOSTAT KNOB	COMMANDE THERMOSTAT	THERMOSTATREGLER
RE150006	INTERRUPTOR DE CONTACTO	CONTACT SWITCH	INTERRUPTEUR DE CONTACT	KONTAKTSCHALTER
RE150009	LUZ PILOTO VERDE	POWER INDICATOR GREEN	VOYANT VERT	GRÜNE KONTROLLLEUCHTE
RE1500091	LUZ PILOTO NARANJA	POWER INDICATOR ORANGE	VOYANT ORANGE	ORANGE KONTROLLLEUCHTE
RE150025	CABLE POTENCIA	POWER CORD	CABLE DE PUISSANCE	STROMKABEL
RE150026	PIE	FOOT	PIED	FUSS
RE150703	ASA LATERAL BAQUELITA	BAKELITE SIDE HANDLE	ANSE LATÉRALE EN BAKÉLITE	SEITLICHR BAKELITGRIF



15001

FREIDORA / FRYER /
FRITEUSE / FRITEUSSE

REF	DESCRIPCIÓN	DESCRIPTION	DESCRIPTION	BESCHREIBUNG
RE15000	CESTA MALLA	MESH BASKET	PANIER À MAILLES	MASCHENKORB
RE150001	RESISTENCIA	ELEMENT	RÉSISTANCE	HEIZELEMENT
RE1500010	CABEZAL	COMPLETE HEAD	TÊTE COMPLÈTE	KOMPLETTER KOPF
RE1500011	TAPÓN + ARANDELA CABLE	CAP + WASHER FOR	EMBOUT + RONDELLE DE	STÖPSEL + DICHTUNGSRING FÜR
	TERMOSTATO	THERMOSTAT CABLE	CABLE DE THERMOSTAT	THERMOSTATKABEL
RE150003	TERMOSTATO	THERMOSTAT	THERMOSTAT	THERMOSTAT
RE150004	TERMOSTATO DE SEGURIDAD	SECURITY THERMOSTAT	THERMOSTAT DE SÉCURITÉ	SICHERHEITSTHERMOSTAT
RE150005	MANDO THERMOSTATO	THERMOSTAT KNOB	COMMANDE THERMOSTAT	THERMOSTATREGLER
RE150006	INTERRUPTOR DE CONTACTO	CONTACT SWITCH	INTERRUPTEUR DE CONTACT	KONTAKTSCHALTER
RE150009	LUZ PILOTO VERDE	POWER INDICATOR GREEN	VOYANT VERT	GRÜNE KONTROLLLEUCHTE
RE1500091	LUZ PILOTO NARANJA	POWER INDICATOR ORANGE	VOYANT ORANGE	ORANGE KONTROLLLEUCHTE
RE150025	CABLE POTENCIA	POWER CORD	CABLE DE PUISSANCE	STROMKABEL
RE150026	PIE	FOOT	PIED	FUSS
RE150703	ASA LATERAL BAQUELITA	BAKELITE SIDE HANDLE	ANSE LATÉRALE EN BAKÉLITE	SEITLICHR BAKELITGRIF



15002

FREIDORA / FRYER /
FRITEUSE / FRITEUSSE

REF	DESCRIPCIÓN	DESCRIPTION	DESCRIPTION	BESCHREIBUNG
RE15000	CESTA MALLA	MESH BASKET	PANIER À MAILLES	MASCHENKORB
RE150001	RESISTENCIA	ELEMENT	RÉSISTANCE	HEIZELEMENT
RE1500011	TAPÓN + ARANDELA CABLE	CAP + WASHER FOR +	EMBOUT + RONDELLE DE CABLE	STÖPSEL + DICHTUNGSRING FÜR
	TERMOSTATO	THERMOSTAT CABLE	DE THERMOSTAT	THERMOSTATKABEL
RE150003	TERMOSTATO	THERMOSTAT	THERMOSTAT	THERMOSTAT
RE150004	TERMOSTATO DE SEGURIDAD	SECURITY THERMOSTAT	THERMOSTAT DE SÉCURITÉ	SICHERHEITSTHERMOSTAT
RE150005	MANDO THERMOSTATO	THERMOSTAT KNOB	COMMANDE THERMOSTAT	THERMOSTATREGLER
RE150006	INTERRUPTOR DE CONTACTO	CONTACT SWITCH	INTERRUPTEUR DE CONTACT	KONTAKTSCHALTER
RE150007	CABEZAL	COMPLETE HEAD	TÊTE COMPLÈTE	KOMPLETTER KOPF
RE150008	INTERRUPTOR	ON/OFF SWITCH	INTERRUPTEUR	AN/ AUSSCHALTER
RE150009	ENCENDIDO/APAGADO		ALLUMAGE/EXTINCTION	AN/ AUSSCHALTER
	LUZ PILOTO VERDE	POWER INDICATOR GREEN	VOYANT VERT	GRÜNE KONTROLLLEUCHTE
	LUZ PILOTO NARANJA	POWER INDICATOR ORANGE	VOYANT ORANGE	ORANGE KONTROLLLEUCHTE
RE150022	GRIFO VACIADO	DRAINAGE TAP	ROBINET VIDANGE	ABLAUFHAHN
RE150023	SOPORTE RESISTENCIA	RESISTANCE SUPPORT	SUPPORT DE RÉSTANCE	HALTERUNG FÜR HEIZELEMENT
RE150024	JUNTA PROTECTORA	RESISTANCE PROTECTOR	ENSEMBLE PROTECTEUR DE	SCHUTZDICHTUNGSRING FÜR
	RESISTENCIA	SEAL	RÉSISTANCE	HEIZELEMENT
RE150025	CABLE POTENCIA	POWER CORD	CABLE DE PUISSANCE	STROMKABEL
RE150026	PIE	FOOT	PIED	FUSS



15003

FREIDORA / FRYER /
FRITEUSE / FRITTEUSE

REF	DESCRIPCIÓN	DESCRIPTION	DESCRIPTION	BESCHREIBUNG
RE15000	CESTA MALLA	MESH BASKET	PANIER À MAILLES	MASCHENKORB
RE150001	RESISTENCIA	ELEMENT	RÉSISTANCE	HEIZELEMENT
RE1500011	TAPÓN + ARANDELA CABLE	CAP + WASHER FOR	EMBOUT + RONDELLE DE	STÖPSEL + DICHTUNGSRING
	TERMOSTATO	THERMOSTAT CABLE	CABLE DE THERMOSTAT	FÜR THERMOSTATKABEL
RE150003	TERMOSTATO	THERMOSTAT	THERMOSTAT	THERMOSTAT
RE150004	TERMOSTATO DE SEGURIDAD	SECURITY THERMOSTAT	THERMOSTAT DE SÉCURITÉ	SICHERHEITSTHERMOSTAT
RE150005	MANDO THERMOSTATO	THERMOSTAT KNOB	COMMANDE THERMOSTAT	THERMOSTATREGLER
RE150006	INTERRUPTOR DE CONTACTO	CONTACT SWITCH	INTERRUPTEUR DE CONTACT	KONTAKTSCHALTER
RE150007	CABEZAL	COMPLETE HEAD	TÊTE COMPLÈTE	KOMPLETTER KOPF
RE150008	INTERRUPTOR	ON/OFF SWITCH	INTERRUPTEUR	AN/ AUSSCHALTER
	ENCENDIDO/APAGADO		ALLUMAGE/EXTINCTION	
RE150009	LUZ PILOTO VERDE	POWER INDICATOR GREEN	VOYANT VERT	GRÜNE KONTROLLLEUCHE
RE1500091	LUZ PILOTO NARANJA	POWER INDICATOR ORANGE	VOYANT ORANGE	ORANGE KONTROLLLEUCHE
RE150022	GRIFO VACIADO	DRAINAGE TAP	ROBINET VIDANGE	ABLAUFHAHN
RE150025	CABLE POTENCIA	POWER CORD	CABLE DE PUISSANCE	STROMKABEL
RE150026	PIE	FOOT	PIED	FUSS



15004

GRILL DE CONTACTO / CONTACT GRILL /
GRILL DE CONTACT / KONTAKTGRILL

REF	DESCRIPCIÓN	DESCRIPTION	DESCRIPTION	BESCHREIBUNG
RE150041	INTERRUPTOR	SWITCH	INTERRUPTEUR	SCHALTER
RE150042	TERMOSTATO	THERMOSTAT	THERMOSTAT	THERMOSTAT
RE150043	TERMOSTATO SEGURIDAD	SECURITY THERMOSTAT	THERMOSTAT SÉCURITÉ	SICHERHEITSTHERMOSTAT
RE150044	MUELLES	SPRING	RESSORTS	FEDERN
RE150045	RESISTENCIA SUPERIOR	UPPER ELEMENT	RÉSISTANCE SUPÉRIEURE	OBERES HEIZELEMENT
RE150046	RESISTENCIA INFERIOR	LOWER ELEMENT	RÉSISTANCE INFÉRIEURE	UNTERES HEIZELEMENT
RE150047	MANGO INOX	ST/STEEL HANDLE	MANCHE INOX	GRIFF ROSTFREIER STAHL
RE150048	SILICONA	SILICONE	SILICONE	SILIKON
RE150049	MANGO INOX + SILICONA	ST/STEEL HANDLE + SILICONE	MANCHE INOX + SILICONE	GRIFF ROSTFREIER STAHL + SILIKON



15005

GRILL DE CONTACTO / CONTACT GRILL /
GRILL DE CONTACT / KONTAKTGRILL

REF	DESCRIPCIÓN	DESCRIPTION	DESCRIPTION	BESCHREIBUNG
RE1500092	FIJACIÓN SOPORTE ASA	FIXING SUPPORT FOR HANDLE	FIXATION DE SUPPORT	GRIFFHALTERUNG
		SWITCH	POUR ANSE	
RE150041	INTERRUPTOR	THERMOSTAT	INTERRUPTEUR	SCHALTER
RE150042	TERMOSTATO	SECURITY THERMOSTAT	THERMOSTAT	THERMOSTAT
RE150043	TERMOSTATO SEGURIDAD	SPRING	THERMOSTAT SÉCURITÉ	SICHERHEITSTHERMOSTAT
RE150044	MUELLES	UPPER ELEMENT	RESSORTS	FEDERN
RE150051	RESISTENCIA SUPERIOR	LOWER ELEMENT	RÉSISTANCE SUPÉRIEURE	OBERES HEIZELEMENT
RE150052	RESISTENCIA INFERIOR	REAR AXLE	RÉSISTANCE INFÉRIEURE	UNTERES HEIZELEMENT
RE150053	EJE POSTERIOR	HANDLE	AXE POSTÉRIEUR	OBERE ACHSE
RE150054	MANGO	SILICONE	MANCHE	GRIFF
RE150055	SILICONA	ST/STEEL HANDLE + SILICONE	SILICONE	SILIKON
RE150056	MANGO INOX + SILICONA		MANCHE INOX + SILICONE	GRIFF ROSTFREIER STAHL + SILIKON

15006

GRILL DE CONTACTO / CONTACT GRILL /
GRILL DE CONTACT / KONTAKTGRILL

REF	DESCRIPCIÓN	DESCRIPTION	DESCRIPTION	BESCHREIBUNG
RE1500092	FIJACIÓN SOPORTE ASA	FIXING SUPPORT FOR HANDLE	FIXATION DE SUPPORT	GRIFFHALTERUNG
			POUR ANSE	
RE150041	INTERRUPTOR	SWITCH	INTERRUPTEUR	SCHALTER
RE150042	TERMOSTATO	THERMOSTAT	THERMOSTAT	THERMOSTAT
RE150043	TERMOSTATO SEGURIDAD	SECURITY THERMOSTAT	THERMOSTAT SÉCURITÉ	SICHERHEITSTHERMOSTAT
RE150044	MUELLES	SPRING	RESSORTS	FEDERN
RE150051	RESISTENCIA SUPERIOR	UPPER ELEMENT	RÉSISTANCE SUPÉRIEURE	OBERES HEIZELEMENT
RE150052	RESISTENCIA INFERIOR	LOWER ELEMENT	RÉSISTANCE INFÉRIEURE	UNTERES HEIZELEMENT
RE150053	EJE POSTERIOR	REAR AXLE	AXE POSTÉRIEUR	OBERE ACHSE
RE150054	MANGO	HANDLE	MANCHE	GRIFF
RE150055	SILICONA	SILICONE	SILICONE	SILIKON
RE150056	MANGO INOX + SILICONA	ST/STEEL HANDLE + SILICONE	MANCHE INOX + SILICONE	GRIFF ROSTFREIER STAHL + SILIKON
RE150061	PLANCHA LISA INFERIOR	LOWER SMOOTH PLATE	PLANCHE LISSE INFÉRIEURE	+ SILIKON



15007

GRILL DE CONTACTO / CONTACT GRILL /
GRILL DE CONTACT / KONTAKTGRILL

REF	DESCRIPCIÓN	DESCRIPTION	DESCRIPTION	BESCHREIBUNG
RE150041	INTERRUPTOR	SWITCH	INTERRUPTEUR	SCHALTER
RE150042	TERMOSTATO	THERMOSTAT	THERMOSTAT	THERMOSTAT
RE150043	TERMOSTATO SEGURIDAD	SECURITY THERMOSTAT	THERMOSTAT SÉCURITÉ	SICHERHEITSTHERMOSTAT
RE150044	MUELLES	SPRING	RESSORTS	FEDERN

15008

GRILL DE CONTACTO / CONTACT GRILL /
GRILL DE CONTACT / KONTAKTGRILL

REF	DESCRIPCIÓN	DESCRIPTION	DESCRIPTION	BESCHREIBUNG
RE150041	INTERRUPTOR	SWITCH	INTERRUPTEUR	SCHALTER
RE150042	TERMOSTATO	THERMOSTAT	THERMOSTAT	THERMOSTAT
RE150043	TERMOSTATO SEGURIDAD	SECURITY THERMOSTAT	THERMOSTAT SÉCURITÉ	SICHERHEITSTHERMOSTAT
RE150044	MUELLES	SPRING	RESSORTS	FEDERN
RE150061	PLANCHA LISA INFERIOR	LOWER SMOOTH PLATE	PLANCHE LISSE INFÉRIEURE	UNTERE GLATTE PLATTE



15009

GRILL DE CONTACTO / CONTACT GRILL /
GRILL DE CONTACT / KONTAKTGRILL

REF	DESCRIPCIÓN	DESCRIPTION	DESCRIPTION	BESCHREIBUNG
RE1500092	FIJACIÓN SOPORTE ASA	FIXING SUPPORT FOR HANDLE	FIXATION DE SUPPORT POUR ANSE	GRIFFHALTERUNG
RE150041	INTERRUPTOR	SWITCH	INTERRUPTEUR	SCHALTER
RE150042	TERMOSTATO	THERMOSTAT	THERMOSTAT	THERMOSTAT
RE150043	TERMOSTATO SEGURIDAD	SECURITY THERMOSTAT	THERMOSTAT SÉCURITÉ	SICHERHEITSTHERMOSTAT
RE150044	MUELLES	SPRING	RESSORTS	FEDERN



15014 / 15015 / 15016 / 15017 / 15018 / 15019 / 15060

BAÑO MARIA 1/1 GN / BAIN-MARIE 1/1 GN /
BAIN-MARIE 1/1 GN / WASSERBAD 1/1 GN

REF	DESCRIPCIÓN	DESCRIPTION	DESCRIPTION	BESCHREIBUNG
RE150141	RESISTENCIA	ELEMENT	RÉSISTANCE	HEIZELEMENT
RE150143	TERMOSTATO SEGURIDAD	SECURITY THERMOSTAT	THERMOSTAT SÉCURITÉ	SICHERHEITSTHERMOSTAT



15010

BAÑO MARIA MÁX. 40 °C / CHOCOLATE WARMER MAX. 40 °C /
CHAUFFE-CHOCOLAT MAX. 40 °C / WASSERBAD MAX. 40 °C

REF	DESCRIPCIÓN	DESCRIPTION	DESCRIPTION	BESCHREIBUNG
RE150101	TERMOSTATO	THERMOSTAT	THERMOSTAT	THERMOSTAT
RE150102	RESISTENCIA	ELEMENT	RÉSISTANCE	HEIZELEMENT



15011

BAÑO MARIA MÁX. 40 °C / CHOCOLATE WARMER MAX. 40 °C /
CHAUFFE-CHOCOLAT MAX. 40 °C / WASSERBAD MAX. 40 °C

REF	DESCRIPCIÓN	DESCRIPTION	DESCRIPTION	BESCHREIBUNG
RE150101	TERMOSTATO	THERMOSTAT	THERMOSTAT	THERMOSTAT
RE150102	RESISTENCIA	ELEMENT	RÉSISTANCE	HEIZELEMENT



15020 / 15021 / 15022 / 15023 / 15024 / 15025 / 15061

BAÑO MARIA 1/1 GN CON GRIFO DESAGÜE / BAIN-MARIE 1/1 GN WITH DRAINAGE TAP /
BAIN-MARIE 1/1 GN AVEC ROBINET DE VIDANGE / WASSERBAD 1/1 GN MIT ABLAUFHAHN

REF	DESCRIPCIÓN	DESCRIPTION	DESCRIPTION	BESCHREIBUNG
RE150201	GRIFO	TAP	ROBINET	ABLAUFHAHN
RE150202	CONECTOR GRIFO	CONNECTOR PLUG	CONNECTEUR DE ROBINET	KONNEKTOR ABLAUFHAHN
RE150203	CONECTOR	CONNECTOR	CONNECTEUR	KONNEKTOR



15026

CALENTADOR DE PLATOS CAPACIDAD 30 U / HOT CUPBOARD CAPACITY 30 U /
CHAUFFE-ASSIETTES CAPACITÉ 30 U / TELLERWÄRMER FASSUNGSVERMÖGEN 30 STÜCK

REF	DESCRIPCIÓN	DESCRIPTION	DESCRIPTION	BESCHREIBUNG
RE150260	SOPORTE PIE	SUPPORT FOOT	SUPPORT PIED	FUSSHALTER
RE150261	ESTANTE	SHELF	ÉTAGÈRE	REGAL
RE150262	RESISTENCIA	ELEMENT	RÉSISTANCE	HEIZELEMENT
RE150263	SOPORTE	SUPPORT	SUPPORT	HALTER



15027

CALENTADOR DE PLATOS CAPACIDAD 60 U / HOT CUPBOARD CAPACITY 60 U /
CHAUFFE-ASSIETTES CAPACITÉ 60 U / TELLERWÄRMER FASSUNGSVERMÖGEN 60 STÜCK

REF	DESCRIPCIÓN	DESCRIPTION	DESCRIPTION	BESCHREIBUNG
RE150271	ESTANTE	SHELF	ÉTAGÈRE	REGAL
RE150272	RESISTENCIA	ELEMENT	RÉSISTANCE	HEIZELEMENT



15028

CALENTADOR DE PLATOS CAPACIDAD 120 U / HOT CUPBOARD CAPACITY 120 U /
CHAUFFE-ASSIETTES CAPACITÉ 120 U / TELLERWÄRMER FASSUNGSVERMÖGEN 120 STÜCK

REF	DESCRIPCIÓN	DESCRIPTION	DESCRIPTION	BESCHREIBUNG
RE150281	ESTANTE	SHELF	ÉTAGÈRE	REGAL
RE150282	RESISTENCIA	ELEMENT	RÉSISTANCE	HEIZELEMENT



15035

HORNO MULTIFUNCIONAL DE CONVECCIÓN / CONVECTION OVEN /
FOUR À AIR PULSE / KONFEKTIONSOFEN

REF	DESCRIPCIÓN	DESCRIPTION	DESCRIPTION	BESCHREIBUNG
RE15035	REJILLA	GRID	GRILLE	GRILLROST
RE1503510	MANDO TEMPORIZADOR	TIMER KNOB	COMMANDE TEMPORISATEUR	TIMERKNOPF
RE1503511	CRISTAL EXTERIOR	GLASS EXTERIOR	VITRE EXTÉRIEURE	AUSSENGLAS
RE1503512	TIRADOR	HANDLE	POIGNÉE	GRIFF
RE1503513	CRISTAL INTERIOR	GLASS INTERIOR	VITRE INTÉRIEURE	INNENGLAS
RE1503514	SOPORTE INFERIOR CRISTAL	GLASS BOTTOM SUPPORT	SUPPORT INFÉRIEUR EN VERRE	HALTER FÜR INNENGLAS
RE1503515	SOPORTE FIJO BISAGRA PARA PUERTA	FIXED SUPPORT WITH HINGE FOR DOOR	SUPPORT FIXE AVEC CHARNIÈRE POUR PORTE	FESTER SCHANIERHALTER FÜR DIE TÜR
RE1503516	SOPORTE TIRADOR PUERTA	DOOR HANDLE SUPPORT	SUPPORT AVEC POIGNÉE DE PORTE	TÜRGRIFFFHALTER
RE1503517	BOMBILLA	LIGHT BULB	AMPOULLE	LAMPE
RE1503518	PROTECTOR BOMBILLA	LIGHT BULB PROTECTOR	PROTECTION D'AMPOULLE	LAMPENSCHUTZ
RE150352	BANDEJA	TRAY	PLATEAU	TABLETT
RE150353	GOMA	RUBBER	CAOUTCHOUC	GUMMI
RE150354	TERMOSTATO	THERMOSTAT	THERMOSTAT	THERMOSTAT
RE150355	TERMOSTATO SEGURIDAD	SECURITY THERMOSTAT	THERMOSTAT SÉCURITÉ	SICHERHEITSTHERMOSTAT
RE150356	BISAGRA	HINGE	CHARNIÈRE	SCHANIER
RE150357	RESISTENCIA	ELEMENT	RÉSISTANCE	HEIZELEMENT
RE150358	VENTILADOR - MOTOR	FAN - MOTOR	VENTILATEUR - MOTEUR	VENTILATIONSMOTOR
RE150359	TEMPORIZADOR	TIMER	TEMPORISATEUR	TIMER



15036

SALAMANDRA CON PARTE SUPERIOR REGULABLE / SALAMANDER WITH ADJUSTABLE TOP /
SALAMANDRE AVEC REGULATION DU PLAFOND / SALAMANDER MIT BEWEGLICHEM OBERTEIL

REF	DESCRIPCIÓN	DESCRIPTION	DESCRIPTION	BESCHREIBUNG
RE150361	RESISTENCIA	ELEMENT	RÉSISTANCE	HEIZELEMENT
RE150362	BANDEJA GOTEÓ	DRIP PLATE	PLATEAU ÉGOUTTAGE	TROPFGITTER
RE150363	TERMOSTATO	THERMOSTAT	THERMOSTAT	THERMOSTAT



15038

TOSTADORA PARA SANDWICH CON 3 Y 6 PINZAS / SANDWICH TOASTER WITH 3 & 6 TONGS /
TOASTEUR À SANDWICH AVEC 3 ET 6 PINCES / SANDWICHTOASTER MIT 3 UND 6 ZANGEN

REF	DESCRIPCIÓN	DESCRIPTION	DESCRIPTION	BESCHREIBUNG
RE150381	RESISTENCIA	ELEMENT	RÉSISTANCE	HEIZELEMENT
RE150382	TERMOSTATO	THERMOSTAT	THERMOSTAT	THERMOSTAT
RE150383	MANDO TEMPORIZADOR	TIMER KNOB	COMMANDE TEMPORISATEUR	TIMERKNOPF
RE150384	MANDO TERMOSTATO	THERMOSTAT KNOB	COMMANDE THERMOSTAT	THERMOSTATREGLER
RE150385	TEMPORIZADOR	TIMER	TEMPORISATEUR	TIMER
RE150386	REGLETA CERÁMICA	CERAMICAL TERMINAL	RÈGLETTE EN CÉRAMIQUE	KERAMISCHE SCHINE
RE150387	PRENSA ESTOPAS	CABLE GLAND	PRESSE-ÉTOUPES	PRESSE- TUCH
RE150388	ASLAMIENTO CERÁMICO	CERAMIC INSULATOR	ISOLANT EN CÉRAMIQUE	KERAMISCHE ISOLIERUNG
RE15039	PINZA SANDWICH	SANDWICH TONG	PINCE À SANDWICH	SANDWICHZANGE



15039

TOSTADORA PARA SANDWICH CON 3 Y 6 PINZAS / SANDWICH TOASTER WITH 3 & 6 TONGS /
TOASTEUR À SANDWICH AVEC 3 ET 6 PINCES / SANDWICHTOASTER MIT 3 UND 6 ZANGEN

REF	DESCRIPCIÓN	DESCRIPTION	DESCRIPTION	BESCHREIBUNG
RE150382	TERMOSTATO	THERMOSTAT	THERMOSTAT	THERMOSTAT
RE150383	MANDO TEMPORIZADOR	TIMER KNOB	COMMANDE TEMPORISATEUR	TIMERKNOPF
RE150384	MANDO TERMOSTATO	THERMOSTAT KNOB	COMMANDE THERMOSTAT	THERMOSTATREGLER
RE150385	TEMPORIZADOR	TIMER	TEMPORISATEUR	TIMER
RE150386	REGLETA CERÁMICA	CERAMICAL TERMINAL	RÈGLETTE EN CÉRAMIQUE	KERAMISCHE SCHIENE
RE150387	PRENSA ESTOPAS	CABLE GLAND	PRESSE-ÉTOUPES	PRESSE- TUCH
RE150388	AISLAMIENTO CERÁMICO	CERAMIC INSULATOR	ISOLANT EN CÉRAMIQUE	KERAMISCHE ISOLIERUNG
RE15039	PINZA SANDWICH	SANDWICH TONG	PINCE À SANDWICH	SANDWICHZANGE
RE150391	RESISTENCIA	ELEMENT	RÉSISTANCE	HEIZELEMENT



15040

TOSTADORA / TOASTER /
TOASTEUR / TOASTER

REF	DESCRIPCIÓN	DESCRIPTION	DESCRIPTION	BESCHREIBUNG
RE150400	PIÉS	FEET	PIEDS	FÜSSE
RE150401	RESISTENCIA 500W	500W ELEMENT	RÉSISTANCE 500W	HEIZELEMENT 500W
RE150402	RESISTENCIA 370W	370W ELEMENT	RÉSISTANCE 370W	HEIZELEMENT 370W
RE150403	TEMPORIZADOR	TIMER	TEMPORISATEUR	TIMER
RE150404	INTERRUPTOR	SWITCH	INTERRUPTEUR	SCHALTER
RE150405	MANDO TEMPORIZADOR	TIMER KNOB	COMMANDE TEMPORISATEUR	TIMERKNOPF



15041

TOSTADORA / TOASTER /
TOASTEUR / TOASTER

REF	DESCRIPCIÓN	DESCRIPTION	DESCRIPTION	BESCHREIBUNG
RE150400	PIÉS	FEET	PIEDS	FÜSSE
RE150403	TEMPORIZADOR	TIMER	TEMPORISATEUR	TIMER
RE150404	INTERRUPTOR	SWITCH	INTERRUPTEUR	SCHALTER
RE150405	MANDO TEMPORIZADOR	TIMER KNOB	COMMANDE TEMPORISATEUR	TIMERKNOPF
RE150411	RESISTENCIA 500W	500W ELEMENT	RÉSISTANCE 500W	HEIZELEMENT 500W
RE150412	RESISTENCIA 370W	370W ELEMENT	RÉSISTANCE 370W	HEIZELEMENT 370W



15042

TOSTADORA CONTINUA / CONVEYOR TOASTER /
TOASTEUR CONVEYEUR / DURCHLAUFTOASTER

REF	DESCRIPCIÓN	DESCRIPTION	DESCRIPTION	BESCHREIBUNG
RE150421	RESISTENCIA SUPERIOR	UPPER ELEMENT	RÉSISTANCE SUPERIOR	OBERES HEIZELEMENT
RE150422	RESISTENCIA INFERIOR	LOWER ELEMENT	RÉSISTANCE INFÉRIEURE	UNTERES HEIZELEMENT
RE150423	MOTOR	MOTOR	MOTEUR	MOTOR
RE150424	VENTILADOR	FAN	VENTILATEUR	VENTILATOR
RE150425	SELECTION SWITCH	SELECTION SWITCH	SÉLECTION INTERRUPTEUR	AUSWAHLSCHALTER
RE150426	REGULADOR VELOCIDAD	ADJUSTABLE SPEED	RÉGULATEUR VITESSE	GESCHWINDIGKEITSREGLER
RE150427	POTENCIOMETRO	POTENTIOMETER	POTENCIOMÈTRE	POTENZREGLER
RE150428	POMO	KNOB	POMMEAU	KNOPF

15043

TOSTADORA CONTINUA / CONVEYOR TOASTER /
TOASTEUR CONVEYEUR / DURCHLAUFTOASTER

REF	DESCRIPCIÓN	DESCRIPTION	DESCRIPTION	BESCHREIBUNG
RE150424	VENTILADOR	FAN	VENTILATEUR	VENTILATOR
RE150425	SELECTION SWITCH	SELECTION SWITCH	SÉLECTION INTERRUPTEUR	AUSWAHLSCHALTER
RE150426	REGULADOR VELOCIDAD	ADJUSTABLE SPEED	RÉGULATEUR VITESSE	GESCHWINDIGKEITSREGLER
RE150431	RESISTENCIA SUPERIOR 1,4W	UPPER ELEMENT 1,4W	RÉSISTANCE SUPÉRIEURE 1,4W	OBERES HEIZELEMENT 1,4W
RE150432	RESISTENCIA INFERIOR 1,2W	LOWER ELEMENT 1,2W	RÉSISTANCE INFÉRIEURE 1,2W	UNTERES HEIZELEMENT 1,2W
RE150433	MOTOR	MOTOR	MOTEUR	MOTOR



15044

MÁQUINA DE COCER PASTA / PASTA COOKER /
CUISEUR À PÂTE / NUDELKOCHER

REF	DESCRIPCIÓN	DESCRIPTION	DESCRIPTION	BESCHREIBUNG
RE150441	CESTA MALLA GRANDE CON ASAS	BIG MESH BASKET WITH HANDLES	PANIER GRANDE MAILLE À ANSES	GROSSER MASCHENKORB MIT GRIFFEN
RE150442	CESTA MALLA PEQUEÑA CON MANGO	SMALL MESH BASKET WITH HANDLE	PANIER PETITE MAILLE À MANCHE	KLEINER MASCHENKORB MIT GRIFFEN
RE150443	TERMOSTATO	THERMOSTAT	THERMOSTAT	THERMOSTAT
RE150444	GRIFO DESAGUE	DRAINAGE TAP	ROBINET ÉCOULEMENT	ABLAUFHAHN
RE150445	CONEXIÓN BM GRIFO DRENAJE	BM CONNECTION DRAINING TAP	CONNECTION BM ROBINET DE DRAINAGE	BM VERBINDUNG ABLAUFHAHN



15070

FREIDORA / FRYER /
FRITEUSE / FRITEUSSE

REF	DESCRIPCIÓN	DESCRIPTION	DESCRIPTION	BESCHREIBUNG
RE1500011	TAPÓN + ARANDELA CABLE TERMOSTATO	CAP + WASHER FOR THERMOSTAT CABLE	EMBOUT + RONDELLE DE CABLE DE THERMOSTAT	STÖPSEL + DICHTUNGSRING FÜR THERMOSTATKABEL
RE150003	TERMOSTATO	THERMOSTAT	THERMOSTAT	THERMOSTAT
RE150004	TERMOSTATO DE SEGURIDAD	SECURITY THERMOSTAT	THERMOSTAT DE SÉCURITÉ	SICHERHEITSTHERMOSTAT
RE150005	MANDO TERMOSTATO	THERMOSTAT KNOB	COMMANDE THERMOSTAT	THERMOSTATREGLER
RE150006	INTERRUPTOR DE CONTACTO	CONTACT SWITCH	INTERRUPTEUR DE CONTACT	KONTAKTSCHALTER
RE150009	LUZ PILOTO VERDE	POWER INDICATOR GREEN	VOYANT VERT	GRÜNE KONTROLLLEUCHTE
RE1500091	LUZ PILOTO NARANJA	POWER INDICATOR ORANGE	VOYANT ORANGE	ORANGE KONTROLLLEUCHTE
RE150025	CABLE POTENCIA	POWER CORD	CABLE DE PUISSANCE	STROMKABEL
RE150026	PIE	FOOT	PIED	FUSS
RE15070	CESTA MALLA	MESH BASKET	PANIER MAILLE	MASCHENKORB
RE150701	RESISTENCIA	ELEMENT	RÉSISTANCE	HEIZELEMENT
RE150702	CABEZAL PARA	HEAD	TÊTE	KOPF
RE150703	ASA LATERAL BAQUELITA	BAKELITE SIDE HANDLE	ANSE LATÉRALE EN BAKÉLITE	SEITLICHR BAKELITGRIF



15071

FREIDORA / FRYER /
FRITEUSE / FRITEUSSE

REF	DESCRIPCIÓN	DESCRIPTION	DESCRIPTION	BESCHREIBUNG
RE1500011	TAPÓN + ARANDELA CABLE TERMOSTATO	CAP + WASHER FOR THERMOSTAT CABLE	EMBOUT + RONDELLE DE CABLE DE THERMOSTAT	STÖPSEL + DICHTUNGSRING FÜR THERMOSTATKABEL
RE150003	TERMOSTATO	THERMOSTAT	THERMOSTAT	THERMOSTAT
RE150004	TERMOSTATO DE SEGURIDAD	SECURITY THERMOSTAT	THERMOSTAT DE SÉCURITÉ	SICHERHEITSTHERMOSTAT
RE150005	MANDO TERMOSTATO	THERMOSTAT KNOB	COMMANDE THERMOSTAT	THERMOSTATREGLER
RE150006	INTERRUPTOR DE CONTACTO	CONTACT SWITCH	INTERRUPTEUR DE CONTACT	KONTAKTSCHALTER
RE150009	LUZ PILOTO VERDE	POWER INDICATOR GREEN	VOYANT VERT	GRÜNE KONTROLLLEUCHTE
RE1500091	LUZ PILOTO NARANJA	POWER INDICATOR ORANGE	VOYANT ORANGE	ORANGE KONTROLLLEUCHTE
RE150025	CABLE POTENCIA	POWER CORD	CABLE DE PUISSANCE	STROMKABEL
RE150026	PIE	FOOT	PIED	FUSS
RE15070	CESTA MALLA	MESH BASKET	PANIER MAILLE	MASCHENKORB
RE150701	RESISTENCIA	ELEMENT	RÉSISTANCE	HEIZELEMENT
RE150702	CABEZAL PARA	HEAD	TÊTE	KOPF
RE150703	ASA LATERAL BAQUELITA	BAKELITE SIDE HANDLE	ANSE LATÉRALE EN BAKÉLITE	SEITLICHR BAKELITGRIF



15072

PLACA DE INDUCCIÓN / INDUCTION COOKER /
PLAQUE À INDUCTION / INDUKTIONSKOCHFELD

REF	DESCRIPCIÓN	DESCRIPTION	DESCRIPTION	BESCHREIBUNG
RE15072	CRISTAL	GLASS	VITRE	GLAS
RE150721	CONTROLADOR	CONTROLLER	CONTRÔLEUR	KONTROLLE
RE150722	MARCO ACERO INOX	ST/STEEL FRAME	CADRE EN INOX	RAHMEN ROSTFREIER STAHL
RE150723	PLACA BASE	MAIN BOARD	PLAQUE DE BASE	BASISPLATTE
RE150724	VIDRIO + CARCASSA METÁLICA	GLASS + METAL HOUSING	VITRE + CARCASSE MÉTALLIQUE	GLAS +METALLGEHÄUSE
RE150725	MANDO DE FUNCIONAMIENTO	OPERATIONS CONTROL	COMMANDE DE FONCTIONNEMENT	FUNKTIONSKONTROLLE
RE150726	INDUCTOR	INDUCTOR	INDUCTEUR	INDUKTOR
RE150727	VENTILADOR	VENTILATOR	VENTILATEUR	VENTILATOR



15073 / 15074

PLACA CALIENTE / HEATING PLATE /
PLAQUE CHAUFFANTE / WÄRMEPLATTE

REF	DESCRIPCIÓN	DESCRIPTION	DESCRIPTION	BESCHREIBUNG
RE150740	PIE	BASE	PIED	FUSS



15075 / 15076

CRÉPERA - CRÉPERA DOBLE / CRÊPE MAKER - DOUBLE CRÊPE MAKER /
CRÊPIÈRE - CRÊPIÈRE DOUBLE / CRÊPEEISEN

REF	DESCRIPCIÓN	DESCRIPTION	DESCRIPTION	BESCHREIBUNG
RE150751	RESISTENCIA	ELEMENT	RÉSISTANCE	HEIZELEMENT



15084

PLANCHA ELÉCTRICA LISA / ELECTRIC GRIDDLE PLAIN /
PLAQUE ÉLECTRIQUE UNIE / GLATTER ELEKTRISCHER GRILL

REF	DESCRIPCIÓN	DESCRIPTION	DESCRIPTION	BESCHREIBUNG
RE150841	RESISTENCIA	ELEMENT	RÉSISTANCE	HEIZELEMENT



15097

FUENTE FONDUE CHOCOLATE / CHOCOLATE FOUNTAIN /
FONTAINE À CHOCOLAT / SCHOKOLADENBRUNNEN

REF	DESCRIPCIÓN	DESCRIPTION	DESCRIPTION	BESCHREIBUNG
RE150971	ESPIRAL INTERIOR PLÁSTICO	INTERIOR PLASTIC SPIRALE	SPIRALE INTÉRIEUR EN PLASTIQUE	INNERE PLASTIKSPIRALE
RE1509741	CARCASA CILÍNDRICA	CYLINDRICAL CARCASE	CARCASSE CYLINDRIQUE	ZYLINDERGEHÄUSE
RE1509744	POMO DE PLÁSTICO	PLASTIC KNOB	POMMEAU EN PLASTIQUE	PLASTIKKNOPF
RE150978	ARANDELA SILICONA	SILICONE WASHER	RONDELLE EN SILICONE	SILIKONDICHTUNG
RE1509799	KIT FUENTE	FOUNTAIN KIT	KIT SOURCE	BRUNNENSET



19114-N / 19114-A / 19114-R

POSTE CON CINTA RETRÁCTIL ACERO INOX BRILLANTE / BARRIER WITH RETRACTABLE BELT. MIRROR POLISHED /
POTEAU DÉROULEUR À SANGLE. ACIER INOX BRILLANT / SEPERATIONSPFOSTEN MIT EINZIEHBAREM BAND GLÄNZEND

REF	DESCRIPCIÓN	DESCRIPTION	DESCRIPTION	BESCHREIBUNG
RE191110	PIEZA PLÁSTICO	PLASTIC PIECE	PIÈCE EN PLASTIQUE	PLASTIKTEIL
RE191140	BASE	BASE	BASE	BASIS



23003

TETERA "JAPON" / "JAPAN" TEA POT /
THIÈRE "JAPON" / "JAPAN" TEEKANNE

REF	DESCRIPCIÓN	DESCRIPTION	DESCRIPTION	BESCHREIBUNG
RE23003	FILTRO	FILTER	FILTRE	FILTER

23004

TETERA / TEA POT /
THIÈRE / TEEKANNE

REF	DESCRIPCIÓN	DESCRIPTION	DESCRIPTION	BESCHREIBUNG
RE230049	FILTRO	FILTER	FILTRE	FILTER



23005

QUEMADOR GAS INDUSTRIAL / INDUSTRIAL GAS BURNER /
BRÛLEUR À GAZ INDUSTRIEL / INDUSTRIELLER GASBRENNER

REF	DESCRIPCIÓN	DESCRIPTION	DESCRIPTION	BESCHREIBUNG
RE230051	FOGÓN	BURNER	BRÛLEUR	BRENNER



23008

TETERA "NIPON" / "NIPON" TEA POT /
THIÈRE "NIPON" / "NIPON" TEEKANNE

REF	DESCRIPCIÓN	DESCRIPTION	DESCRIPTION	BESCHREIBUNG
RE23008	FILTRO	FILTER	FILTRE	FILTER

23009

TETERA / TEA POT /
THIÈRE / TEEKANNE

REF	DESCRIPCIÓN	DESCRIPTION	DESCRIPTION	BESCHREIBUNG
RE230049	FILTRO	FILTER	FILTRE	FILTER



23010

TETERA "ASIA" / "ASIA" TEA POT /
THIÈRE "ASIA" / "ASIA" TEEKANNE

REF	DESCRIPCIÓN	DESCRIPTION	DESCRIPTION	BESCHREIBUNG
RE23010	FILTRO	FILTER	FILTRE	FILTER



248.028 / 248.032 / 248.035 / 248.040 / 248.045

OLLA CON GRIFO Y TAPA / STOCK POT WITH TAP AND LID /
MARMITE TRAITEUR AVEC ROBINET ET COUVERCLE / KOCHTOPF MIT ABLAUFHAHN UND DECKEL

REF	DESCRIPCIÓN	DESCRIPTION	DESCRIPTION	BESCHREIBUNG
IV248000	GRIFO INOX	INOX TAP	ROBINET INOX	GRIFF ROSTFREIER STAHL



313.025

PASAPURÉS / VEGETABLE SIEVE /
MOULIN À LÉGUMES / PÜRIERSIEB

REF	DESCRIPCIÓN	DESCRIPTION	DESCRIPTION	BESCHREIBUNG
RE3130251	FILTRO FINO	THIN FILTER	FILTRE FIN	FEINER FILTER
RE3130252	FILTRO GRUESO	THICK FILTER	FILTRE EPAIS	GROBER FILTER
RE3130253	POMO	KNOB	POMMEAU	KNOPF
RE3130254	MECANISMO	MECHANISM	MÉCANISME	MECHANISMUS
RE3130255	ASA	HANDLE	ANSE	GRIFF

313.030

PASAPURÉS / VEGETABLE SIEVE /
MOULIN À LÉGUMES / PÜRIERSIEB

REF	DESCRIPCIÓN	DESCRIPTION	DESCRIPTION	BESCHREIBUNG
RE3130301	FILTRO FINO	THIN FILTER	FILTRE FIN	FEINER FILTER
RE3130302	FILTRO GRUESO	THICK FILTER	FILTRE EPAIS	GROBER FILTER
RE3130303	POMO	KNOB	POMMEAU	KNOPF
RE3130304	MECANISMO	MECHANISM	MÉCANISME	MECHANISMUS



313.126

PASAPURÉS / VEGETABLE SIEVE /
MOULIN À LÉGUMES / PÜRIERSIEB

REF	DESCRIPCIÓN	DESCRIPTION	DESCRIPTION	BESCHREIBUNG
RE3130261	FILTRO FINO	THIN FILTER	FILTRE FIN	FEINER FILTER
RE3130262	FILTRO GRUESO	THICK FILTER	FILTRE EPAIS	GROBER FILTER
RE3130263	POMO	KNOB	POMMEAU	KNOPF
RE3130264	MECANISMO	MECHANISM	MÉCANISME	MECHANISMUS

313.132

PASAPURÉS / VEGETABLE SIEVE /
MOULIN À LÉGUMES / PÜRIERSIEB

REF	DESCRIPCIÓN	DESCRIPTION	DESCRIPTION	BESCHREIBUNG
RE3130263	POMO	KNOB	POMMEAU	FEINER FILTER
RE3130321	FILTRO FINO	THIN FILTER	FILTRE FIN	GROBER FILTER
RE3130322	FILTRO GRUESO	THICK FILTER	FILTRE EPAIS	KNOPF
RE3130324	MECANISMO	MECHANISM	MÉCANISME	MECHANISMUS



337.030 / 337.060 / 337.090 / 337.150 / 337.200

JARRA TERMO / INSULATED COFFEE POT /
PICHET ISOLANTE / THERMOSKANNE

REF	DESCRIPCIÓN	DESCRIPTION	DESCRIPTION	BESCHREIBUNG
RE337001	TAPA	LID	COUVERCLE	DECKEL



371.000

SOPORTE DE PARED CON 5 GANCHOS / 5-HOOK RACK /
SUPPORT AVEC 5 CROCHETS / WANDHALTERUNG 5 HAKEN

REF	DESCRIPCIÓN	DESCRIPTION	DESCRIPTION	BESCHREIBUNG
RE371000	GANCHOS	HOOKS	CROCHETS	HAKEN



379.065

CHAFING DISH CON TAPA / CHAFING DISH WITH LID /
CHAFING DISH AVEC COUVERCLE / CHAFING DISH MIT DECKEL

REF	DESCRIPCIÓN	DESCRIPTION	DESCRIPTION	BESCHREIBUNG
RE379065	TAPA	LID	COUVERCLE	DECKEL



387.065

CHAFING DISH CON TAPA TIPO ROLL TOP / CHAFING DISH WITH ROLL TOP LID /
CHAFING DISH AVEC COUVERCLE ROLL TOP / CHAFING DISH MIT ROLLDECKEL

REF	DESCRIPCIÓN	DESCRIPTION	DESCRIPTION	BESCHREIBUNG
RE387065	TAPA	LID	COUVERCLE	DECKEL
RE3870651	SOPORTE CON PATAS	SUPPORT WITH LEGS	SUPPORT AVEC PIEDS	STÄNDER MIT FÜSSEN



602.015

BALANZA MECÁNICA / MECHANICAL SCALE /
BALANCE AUTOMATIQUE / MECHANISCHE WAAGE

REF	DESCRIPCIÓN	DESCRIPTION	DESCRIPTION	BESCHREIBUNG
RE602015	BANDEJA	TRAY	PLATEAU	TABLETT



623.002 / 623.003

PORTASALADOS O PORTASALSAS / SNACK OR SAUCE BOWL SET /
ENSEMBLE BOL POUR SNACKS OU SAUCES / SNACK ODER SOSSENHALTER

REF	DESCRIPCIÓN	DESCRIPTION	DESCRIPTION	BESCHREIBUNG
RE623000	RECIPIENTE	CONTAINER	RECIPIENT	BEHÄLTER



641.100

CARRO DE SERVICIO / TROLLEY /
CHARIOT DE SERVICE / SERVICEWAGEN

REF	DESCRIPCIÓN	DESCRIPTION	DESCRIPTION	BESCHREIBUNG
RE641101	TUBO	TUBE	TUBE	ROHR
RE641102	RUEDAS	WHEELS	ROUES	RÄDER
RE641103	BANDEJAS	TRAYS	PLATEAUS	TABLETTES
RE641104	ASAS	HANDLES	ANSES	GRIFFE



646.000

SOPORTE DE MESA PARA CUBO CHAMPÁN / CHAMPAGNE BUCKET HOLDER /
SUPPORT DE TABLE POUR SEAU À CHAMPAGNE / TISCHHALTERUNG FÜR CAMPAGNERKÜHLER

REF	DESCRIPCIÓN	DESCRIPTION	DESCRIPTION	BESCHREIBUNG
RE646000	TAPÓN	TOP	EMBOUT	STÖPSEL



81000

ARMARIO CALIENTE / HOT CUPBOARD /
ARMOIRE CHAUDE / HEIZSCHRANK

REF	DESCRIPCIÓN	DESCRIPTION	DESCRIPTION	BESCHREIBUNG
RE81000	MANETA INOX CON LLAVE	INOX HANDLE WITH KEY	MANETTE INOX AVEC CLÉ	TÜRGRIF MIT SCHLÜSSEL ROSTFREIER STAHL



830.001 / 830.002

EMBUDO DOSIFICADOR / CONFECTIONERY FUNNEL /
ENTONNOIR DOSEUR / DOSIERUNGSTRICHTER

REF	DESCRIPCIÓN	DESCRIPTION	DESCRIPTION	BESCHREIBUNG
RE8300010	BOQUILLA 4 mm	TUBE	DOUILLE	TÜLLE 4 MM
RE8300011	BOQUILLA 6 mm	TUBE	DOUILLE	TÜLLE 6 MM



834.000

TAPA RECTANGULAR GN POLICARBONATO / GN POLYCARBONATE RECTANGULAR LID /
COUVERCLE RECTANGULAIRE GN POLYCARBONATE / RECHTECKIGER GN DDECKEL POLYCARBONAT

REF	DESCRIPCIÓN	DESCRIPTION	DESCRIPTION	BESCHREIBUNG
RE834000	ASAS	HANDLES	ANSES	GRIFFE



835.000

CAMPANA GN POLICARBONATO / GN POLYCARBONATE DOME LID /
DÔME PROTECTION GN POLYCARBONATE / GN HAUBE POLYCARBONAT

REF	DESCRIPCIÓN	DESCRIPTION	DESCRIPTION	BESCHREIBUNG
RE835000	ASAS	HANDLES	ANSES	GRIFFE



837.003

EXPOSITOR TARTAS ALUMINIO / ALUMINIUM CAKE STAND /
PRÉSENTOIR TARTES ALUMINIUM / TORTENSTÄNDER ALUMINIUM

REF	DESCRIPCIÓN	DESCRIPTION	DESCRIPTION	BESCHREIBUNG
RE837106	DISCO 20 cm	DISK 20 cm	DISQUE 20 cm	SCHEIBE 20 CM
RE837107	DISCO 26 cm	DISK 26 cm	DISQUE 26 cm	SCHEIBE 26 CM
RE837108	DISCO 32 cm	DISK 32 cm	DISQUE 32 cm	SCHEIBE 32 CM
RE837112	TORNILLO SUPERIOR	HEAD SCREW	VIS SUPÉRIEUR	KOPFSCHRAUBE
RE837113	PATA DE LA BASE CON TORNILLO	OUTSIDE FOOT WITH SCREW	PIED DE LA BASE AVEC VIS	STÄNDERFUSS MIT SCHRAUBE
RE837114	TUBO CENTRAL (UNA PARTE)	CONNECTION (PILLAR)	TUBE CENTRAL (UNE PARTIE)	ZENTRALROHR (EIN STÜCK)
RE837115	PATA CENTRAL	MIDDLE FOOT	PIED CENTRAL	ZENTRALFUSS

837.005

EXPOSITOR TARTAS ALUMINIO / ALUMINIUM CAKE STAND /
PRÉSENTOIR TARTES ALUMINIUM / TORTENSTÄNDER ALUMINIUM

REF	DESCRIPCIÓN	DESCRIPTION	DESCRIPTION	BESCHREIBUNG
RE837106	DISCO 20 cm	DISK 20 cm	DISQUE 20 cm	SCHEIBE 20 CM
RE837107	DISCO 26 cm	DISK 26 cm	DISQUE 26 cm	SCHEIBE 26 CM
RE837108	DISCO 32 cm	DISK 32 cm	DISQUE 32 cm	SCHEIBE 32 CM
RE837109	DISCO 40 cm	DISK 40 cm	DISQUE 40 cm	SCHEIBE 40 CM
RE837110	DISCO 45 cm	DISK 45 cm	DISQUE 45 cm	SCHEIBE 45 CM
RE837112	TORNILLO SUPERIOR	HEAD SCREW	VIS SUPÉRIEUR	KOPFSCHRAUBE
RE837113	PATA DE LA BASE CON TORNILLO	OUTSIDE FOOT WITH SCREW	PIED DE LA BASE AVEC VIS	STÄNDERFUSS MIT SCHRAUBE
RE837114	TUBO CENTRAL (UNA PARTE)	CONNECTION (PILLAR)	TUBE CENTRAL (UNE PARTIE)	ZENTRALROHR (EIN STÜCK)
RE837115	PATA CENTRAL	MIDDLE FOOT	PIED CENTRAL	ZENTRALFUSS

837.007

EXPOSITOR TARTAS ALUMINIO / ALUMINIUM CAKE STAND /
PRÉSENTOIR TARTES ALUMINIUM / TORTENSTÄNDER ALUMINIUM

REF	DESCRIPCIÓN	DESCRIPTION	DESCRIPTION	BESCHREIBUNG
RE837105	DISCO 16 cm	DISK 16 cm	DISQUE 16 cm	SCHEIBE 16 CM
RE837106	DISCO 20 cm	DISK 20 cm	DISQUE 20 cm	SCHEIBE 20 CM
RE837107	DISCO 26 cm	DISK 26 cm	DISQUE 26 cm	SCHEIBE 26 CM
RE837108	DISCO 32 cm	DISK 32 cm	DISQUE 32 cm	SCHEIBE 32 CM
RE837109	DISCO 40 cm	DISK 40 cm	DISQUE 40 cm	SCHEIBE 40 CM
RE837110	DISCO 45 cm	DISK 45 cm	DISQUE 45 cm	SCHEIBE 45 CM
RE837111	DISCO 50 cm	DISK 50 cm	DISQUE 50 cm	SCHEIBE 50 CM
RE837112	TORNILLO SUPERIOR	HEAD SCREW	VIS SUPÉRIEUR	KOPFSCHRAUBE
RE837113	PATA DE LA BASE CON TORNILLO	OUTSIDE FOOT WITH SCREW	PIED DE LA BASE AVEC VIS	STÄNDERFUSS MIT SCHRAUBE
RE837114	TUBO CENTRAL (UNA PARTE)	CONNECTION (PILLAR)	TUBE CENTRAL (UNE PARTIE)	ZENTRALROHR (EIN STÜCK)
RE837115	PATA CENTRAL	MIDDLE FOOT	PIED CENTRAL	ZENTRALFUSS



868.001 / 868.002 / 868.003

DISPENSADOR A PRESIÓN / SQUEEZE DISPENSER /
DISTRIBUTEUR À PRESSION / DRUCKDOSSIERER

REF	DESCRIPCIÓN	DESCRIPTION	DESCRIPTION	BESCHREIBUNG
RE868123	TAPÓN ROJO	RED LID	EMBOUT ROUGE	ROTER DECKEL
RE868456	TAPÓN AMARILLO	YELLOW LID	EMBOUT JAUNE	GELBER DECKEL
RE868789	TAPÓN TRANSPARENTE	TRANSPARENT LID	EMBOUT TRANSPARENT	TRANSPARENTER DECKEL



869.005 / 869.010 / 869.019 / 869.038

BOTELLA BAR / BAR KEEP /
BOUTEILLE DE BAR / BARFLASCHE

REF	DESCRIPCIÓN	DESCRIPTION	DESCRIPTION	BESCHREIBUNG
RE869000	SURTIDO TAPONES	CAPS ASSORTMENT	LOT D'EMBOUTS	AUSGUSSTÖPSEL



873.045 / 873.060 / 873.090

BARRA DE NOTAS DE ALUMINIO / ALUMINIUM CHECK MINDER /
BARRE PORTE-BONS EN ALUMINIUM / NOTIZLEISTE ALUMINIUM

REF	DESCRIPCIÓN	DESCRIPTION	DESCRIPTION	BESCHREIBUNG
RE873000	BOLAS	BALLS	BOULES	BÄLLE



894.003 / 894.004 / 894.005

TERMO CON DOSIFICADOR / AIR POT /
VERSEUSE À POMPE / THERMOSKANNE MIT SPENDER

REF	DESCRIPCIÓN	DESCRIPTION	DESCRIPTION	BESCHREIBUNG
RE894000	TAPA	LID	COUVERCLE	DECKEL
RE894001	ARANDELA TAPA	COVER WASHER	RONDELLE DE FERMETURE	DECKELDICHTUNG



895.006 / 895.010 / 895.015

TERMO CON DOSIFICADOR / AIR POT /
VERSEUSE À POMPE / THERMOSKANNE MIT DOSIERER

REF	DESCRIPCIÓN	DESCRIPTION	DESCRIPTION	BESCHREIBUNG
RE895000	TAPA	LID	COUVERCLE	DECKEL

895.020

TERMO CON DOSIFICADOR / AIR POT /
VERSEUSE À POMPE / THERMOSKANNE MIT DOSIERER

REF	DESCRIPCIÓN	DESCRIPTION	DESCRIPTION	BESCHREIBUNG
RE895000	TAPA	LID	COUVERCLE	DECKEL
RE895001	TAPA	LID	COUVERCLE	DECKEL



896.003

JARRA PARA INFUSIONES / COFFEE MAKER - HERBAL TEA JUG /
POT À INFUSIONS / KAFFEE- UND TEEMACHER

REF	DESCRIPCIÓN	DESCRIPTION	DESCRIPTION	BESCHREIBUNG
RE896003	CRISTAL 0,35 LTS	GLASS 0,35 LTS	VERRE 0,35 LTS	GLASBEHÄLTER 0,35L

896.008

JARRA PARA INFUSIONES / COFFEE MAKER - HERBAL TEA JUG /
POT À INFUSIONS / KAFFEE- UND TEEMACHER

REF	DESCRIPCIÓN	DESCRIPTION	DESCRIPTION	BESCHREIBUNG
RE896008	CRISTAL 0,80 LTS	GLASS 0,80 LTS	VERRE 0,80 LTS	GLASBEHÄLTER 0,80L



897.500

CHAFING DISH REDONDO TAPA ROLL TOP / ROUND CHAFING DISH ROLL TOP LID /
CHAFING DISH ROND AVEC COUVERCLE ROLL TOP / RUNDER CHAFING DISH MIT ROLLDECKEL

REF	DESCRIPCIÓN	DESCRIPTION	DESCRIPTION	BESCHREIBUNG
RE897500	CUBETA	CONTAINER	BAC	BEHÄLTER



910.008

OLLA ELÉCTRICA PARA BUFFET / SOUP KETTLE /
MARMITE BUFFET CHAUD / ELEKTRISCHER TOPF

REF	DESCRIPCIÓN	DESCRIPTION	DESCRIPTION	BESCHREIBUNG
RE910000	CONTAINER INTERIOR INOX	ST/STEEL INNER CONTAINER	BAC INTÉRIEUR EN INOX	INNENBEHÄLTER ROSTFREIER STAHL
RE910001	RESISTENCIA	ELEMENT	RÉSISTANCE	HEIZELEMENT
RE910002	TERMOSTATO	THERMOSTAT	THERMOSTAT	THERMOSTAT
RE910003	CONTROLADOR TEMPERATURA	TEMPERATURE CONTROLLER	CONTRÔLEUR DE TEMPÉRATURE	TEMPERATURREGLER
RE910004	CONJUNTO PILOTO NEON	NEON PILOT SET	SET VOYANTS EN NEON	KONTROLLLEUCHTENSET
RE910005	FUSIBLE	FUSE	FUSIBLE	SICHERUNG
RE910006	TAPA INOX	ST/STEEL LID	COUVERCLE INOX	DECKEL ROSTFREIER STAHL
RE910007	POMO PARA TAPA INOX	KNOB FOR INOX LID	POMMEAU POUR COUVERCLE EN INOX	DECKELKNOPF
RE910008	CONTAINER INTERIOR ALUMINIO	ALUMINIUM INNER CONTAINER	BAC INTÉRIEUR EN ALUMINIUM	INNENBEHÄLTER ALUMINIUM



911 / 912 / 913

TABLAS DE CORTE / CUTTING BOARDS /
PLANCHES À DÉCOUPER / SCHNEIDEBRETTER

REF	DESCRIPCIÓN	DESCRIPTION	DESCRIPTION	BESCHREIBUNG
RE911000	PIÉS	FEET	PIEDS	FÜSSE



918.000

LAVA-RACIONADOR ACERO INOXIDABLE / ST/STEEL SCOOP-WASHER /
RINCE-CUILLÈRES ACIER INOXYDABLE / PORTIONIERERSPÜLE ROSTFREIER STAHL

REF	DESCRIPCIÓN	DESCRIPTION	DESCRIPTION	BESCHREIBUNG
RE918001	GRIFO	TAP	ROBINET	HAHN
RE918002	CUBETA CON 1 AGUJERO	BAC WITH ONE HOLE	BAC AVEC UNE OUVERTURE	BEHÄLTER MIT 1 ABLAUF



937.000

MÁQUINA MULTI-USOS / VERSATIL MACHINE /
MACHINE UNIVERSEL / MULTIFUNKTIONSMASCHINE

REF	DESCRIPCIÓN	DESCRIPTION	DESCRIPTION	BESCHREIBUNG
RE937001	CORTADOR PATATAS	FRENCH FRY CUTTER	COUPE FRITES	KARTOFFELSCHNEIDER
RE937002	CORTADOR MANZANAS	APPLE CUTTER	COUPE POMMES	APFELSCHNEIDER
RE937003	EXPRIMIDOR ZUMOS	JUICER	PRESS FRUITS	SAFTPRESSE



945.037

HARINERO / FLOUR BIN /
TAMIS À FARINE / MEHLSIEB

REF	DESCRIPCIÓN	DESCRIPTION	DESCRIPTION	BESCHREIBUNG
RE945001	CAJÓN	DRAWER	TIROIR	SCHUBLADE

945.050 / 945.051

HARINERO / FLOUR BIN /
TAMIS À FARINE / MEHLSIEB

REF	DESCRIPCIÓN	DESCRIPTION	DESCRIPTION	BESCHREIBUNG
RE945000	CAJÓN	DRAWER	TIROIR	SCHUBLADE



954.013 / 954.015

EMBUDO CON FILTRO EXTRAÍBLE / FUNNEL WITH REMOVABLE FILTER /
ENTONNOIR AVEC FILTRE EXTRACTIBLE / TRICHTER MIT AUSTAUSCHBAREM SIEB

REF	DESCRIPCIÓN	DESCRIPTION	DESCRIPTION	BESCHREIBUNG
RE9541315	FILTRO	FILTER	FILTRE	FILTER

954.020 / 954.025

EMBUDO CON FILTRO EXTRAÍBLE / FUNNEL WITH REMOVABLE FILTER /
ENTONNOIR AVEC FILTRE EXTRACTIBLE / TRICHTER MIT AUSTAUSCHBAREM SIEB

REF	DESCRIPCIÓN	DESCRIPTION	DESCRIPTION	BESCHREIBUNG
RE9542025	FILTRO	FILTER	FILTRE	FILTER



964.000

ABRELATAS INDUSTRIAL / CAN OPENER /
OUVRE-BOÎTES PROFESSIONNEL / INDUSTRIELLER DOSENÖFFNER

REF	DESCRIPCIÓN	DESCRIPTION	DESCRIPTION	BESCHREIBUNG
RE964100	CUCHILLA	KNIFE	COUPEAU	KLINGE
RE964200	RODILLO	WHEEL	ROULEAU	RAD
RE964300	MECANISMO	MECHANISM	MÉCANISME	MESCHANISMUS



975.000

CORTADOR DE PATATAS FRITAS / FRENCH FRY CUTTER /
COUPE FRITES / POMMESSCHNEIDER

REF	DESCRIPCIÓN	DESCRIPTION	DESCRIPTION	BESCHREIBUNG
RE975001	CUCHILLA 36 AGUJEROS	KNIFE 36 HOLES	COUPEAU 36 TROUS	SCHNEIDEGITTER 36 LÖCHER
RE975002	CUCHILLA 64 AGUJEROS	KNIFE 64 HOLES	COUPEAU 64 TROUS	SCHNEIDEGITTER 64 LÖCHER



999.000

TRÍPODE PAELLERO / BASE FOR BURNER /
PIED POUR BRÛLEUR / STÄNDER FÜR GASBRENNER

REF	DESCRIPCIÓN	DESCRIPTION	DESCRIPTION	BESCHREIBUNG
RE999000	TAPÓN PLÁSTICO CUADRADO	SQUARE PLASTIC CAP	EMBOUT CARRÉ EN PLASTIQUE	QADRATISCHER PLASTIKSTÖPSEL



BB180PE

BATIDORA NUBLEND / NUBLEND BLENDER /
BLENDER NUBLEND / NUBLEND MIXER

REF	DESCRIPCIÓN	DESCRIPTION	DESCRIPTION	BESCHREIBUNG
RE026280E	JARRA COPOLIÉSTER 1,4 L	COPOLYESTER JAR 1,4 L	BOL EN COPOLYESTER DE 1,4 L	BEHÄLTER COPOLYESTER 1,4 L
RE026281V	TAPA PARA JARRA	LID FOR JAR	COUVERCLE POUR BOL	DECKEL
RE026282E	TAPÓN EXTRAIBLE PARA TAP	REMOVABLE CENTER CAP FOR COVER	EMBOUT EXTRACTIBLE POUR COUVERCLE	ABNEHMBARER DECKELVERSCHLUSS
RE026284	JUNTA GOMA PARA JARRA	JAR SEAL	JOINT EN GOMME POUR CARAFE	DICHUNGSGUMMI FÜR BEHÄLTER
RE026285	PORTE INFERIOR JARRA	BOTTOM JAR	BASE INFÉRIEURE POUR BOL	BEHÄLTERINNENTEIL
RE503377	CUCHILLA MEZCLADORA	BLENDING ASSEMBLY	CUILLÈRE MIXEUSE	MIXERMESSE



BB185PE / BB185SE

BATIDORA NUBLEND / NUBLEND BLENDER /
BLENDER NUBLEND / NUBLEND MIXER

REF	DESCRIPCIÓN	DESCRIPTION	DESCRIPTION	BESCHREIBUNG
RE026870	PANEL DE CONTROL	CONTROL MODULE PANEL	CONTROLE	KONTROLLPLATTE



IC70E

TRITURADOR DE HIELO PROFESIONAL / PROFESSIONEL ICE CRUSHER /
BROYEUR À GLACE PROFESSIONAL / PROFESSIONELLER EISCRUSHER

REF	DESCRIPCIÓN	DESCRIPTION	DESCRIPTION	BESCHREIBUNG
IC70CHUTE	EMBUDO	ICE CHUTE	ENTONNOIR À GLAÇONS	EISTRICHTER
IC70CONT	CONTAINER POLICARBONATO	POLYCARBONATE CONTAINER	BAC À GLACE	BEHÄLTER POLYCARBONAT



MMB145CE / MMB150CE / MMB160CE

BATIDORA DE VASO MARGARITA MADNESS® ELITE / MARGARITA MADNESS® ELITE SERIES BLENDERS /
BLENDERS MARGARITA MADNESS® ELITE / STANDMIXER MARGARITA MADNESS® ELITE

REF	DESCRIPCIÓN	DESCRIPTION	DESCRIPTION	BESCHREIBUNG
RE030853	TAPÓN EXTRAIBLE TAPA	CENTER LID	BOUCHON DOSEUR AMOVIBLE	ABNEHMBARER DECKELVERSCHLUSS
RE030854	TAPA EXTERIOR	OUTER LID	COUVERCLE	AUSSENDECKEL
RE030856	JARRA COPOLIÉSTER 1,4 L CON CUCHILLA MEZCLADORA	JAR COPOLYESTER WITH BLENDING ASSEMBLY 1,4 L	BOL 1,4 L COPOLYESTER AVEC ENSEMBLE COUTEAU	BEHÄLTER COPOLYESTER 1,4 L MIT MIXERMESSE
RE032496	ACOPLAMIENTO INOX	DRIVE COUPLING ST/STEEL	COUPLEUR INOX	KUPPLUNGSEINHEIT ROSTFREIER STAHL



MX1000TXEE / MX1000XTPEE

BATIDORA ALTA POTENCIA / HI-POWERBLENDER /
BLENDER À HAUTE PUISSANCE / HOCHLEISTUNGSMIXER

REF	DESCRIPCIÓN	DESCRIPTION	DESCRIPTION	BESCHREIBUNG
CAC901	JARRA ACERO INOXIDABLE 2 L	STAINLESS STEEL JAR 2 L	BOL EN ACIER INOXYDABLE DE 2 L	BEHÄLTER ROSTFREIER STAHL 2L
CAC931	JARRA COPOLIÉSTER 1,4 L	COPOLYESTER JAR 1,4 L	BOL EN COPOLYESTER DE 1,4 L	BEHÄLTER COPOLYESTER 1,4 L
RE503351	LLAVE DE TUERCA ACOPLAMIENTO	COUPLING WRENCH	CLÉ D'ACOUPLEMENT	KUPPLUNGSSCHRAUBENSCHLÜSSEL



MX1050TXSEE / MX1050XTPEE

BATIDORA ALTA POTENCIA / HI-POWERBLENDER /
BLENDER À HAUTE PUISSANCE / HOCHLEISTUNGSMIXER

REF	DESCRIPCIÓN	DESCRIPTION	DESCRIPTION	BESCHREIBUNG
CAC901	JARRA ACERO INOXIDABLE 2 L	STAINLESS STEEL JAR 2 L	BOL EN ACIER INOXYDABLE DE 2 L	BEHÄLTER ROSTFREIER STAHL 2 L
CAC931	JARRA COPOLIÉSTER 1,4 L	COPOLYESTER JAR 1,4 L	BOL EN COPOLYESTER DE 1,4 L	BEHÄLTER COPOLYESTER 1,4 L



MX1100TXEE / MX1100TXSEE / MX1100XTPEE / MX1100XTPSEE

BATIDORA ALTA POTENCIA / HI-POWERBLENDER /
BLENDER À HAUTE PUISSANCE / HOCHLEISTUNGSMIXER

REF	DESCRIPCIÓN	DESCRIPTION	DESCRIPTION	BESCHREIBUNG
CAC901	JARRA ACERO INOXIDABLE 2 L	STAINLESS STEEL JAR 2 L	BOL EN ACIER INOXYDABLE DE 2 L	BEHÄLTER ROSTFREIER STAHL 2 L
CAC931	JARRA COPOLIÉSTER 1,4 L	COPOLYESTER JAR 1,4 L	BOL EN COPOLYESTER DE 1,4 L	BEHÄLTER COPOLYESTER 1,4 L



MX1200TXEE

BATIDORA ALTA POTENCIA / HI-POWERBLENDER /
BLENDER À HAUTE PUISSANCE / HOCHLEISTUNGSMIXER

REF	DESCRIPCIÓN	DESCRIPTION	DESCRIPTION	BESCHREIBUNG
CAC901	JARRA ACERO INOXIDABLE 2 L	STAINLESS STEEL JAR 2 L	BOL EN ACIER INOXYDABLE DE 2 L	BEHÄLTER ROSTFREIER STAHL 2 L
CAC931	JARRA COPOLIÉSTER 1,4 L	COPOLYESTER JAR 1,4 L	BOL EN COPOLYESTER DE 1,4 L	BEHÄLTER COPOLYESTER 1,4 L



MX1300TXEE / MX1300XTPEE

BATIDORA ALTA POTENCIA / HI-POWERBLENDER /
BLENDER À HAUTE PUISSANCE / HOCHLEISTUNGSMIXER

REF	DESCRIPCIÓN	DESCRIPTION	DESCRIPTION	BESCHREIBUNG
CAC901	JARRA ACERO INOXIDABLE 2 L	STAINLESS STEEL JAR 2 L	BOL EN ACIER INOXYDABLE DE 2 L	BEHÄLTER ROSTFREIER STAHL 2 L
CAC931	JARRA COPOLIÉSTER 1,4 L	COPOLYESTER JAR 1,4 L	BOL EN COPOLYESTER DE 1,4 L	BEHÄLTER COPOLYESTER 1,4 L
RE028393	PANEL DE CONTROL	CONTROL PANEL	CONTRÔLE	KONTROLLPLATTE

MX1500TXEE / MX1500XTPEE

BATIDORA ALTA POTENCIA / HI-POWERBLENDER /
BLENDER À HAUTE PUISSANCE / HOCHLEISTUNGSMIXER

REF	DESCRIPCIÓN	DESCRIPTION	DESCRIPTION	BESCHREIBUNG
CAC901	JARRA ACERO INOXIDABLE 2 L	STAINLESS STEEL JAR 2 L	BOL EN ACIER INOXYDABLE DE 2 L	BEHÄLTER ROSTFREIER STAHL 2 L
CAC931	JARRA COPOLIÉSTER 1,4 L	COPOLYESTER JAR 1,4 L	BOL EN COPOLYESTER DE 1,4 L	BEHÄLTER COPOLYESTER 1,4 L
RE028397	PANEL DE CONTROL	CONTROL PANEL	CONTRÔLE	KONTROLLPLATTE
RE029812	PANEL DE CONTROL	CONTROL PANEL	CONTRÔLE	KONTROLLPLATTE
RE029816	SOFT START PARA PANEL DE CONTROL	SOFT START CONTROL PANEL	SOFT START CONTROL PANEL	SANFTER START KONTROLLPLATTE



WFP14SCE

PROCESADOR ALIMENTOS / FOOD PROCESSOR /
ROBOT MULTIFONCTIONS / LEBENSMITTELROBOTER

REF	DESCRIPCIÓN	DESCRIPTION	DESCRIPTION	BESCHREIBUNG
WFP14S1	CUCHILLA HERMÉTICA	SEALED, SERRATED S-BLADE	LAME HERMÉTIQUE	HERMETISCHES MESSER
WFP14S10	DISCO REBANADOR AJUSTABLE	ADJUSTABLE SLICING DISC	DISQUE À TRANCHER RÉGLABLE	EINSTELLBARER SCHEIBENSCHNEIDER
WFP14S11	DISCO BATIDOR HERMÉTICO	SEALED WHIPPING DISC	DISQUE À FOUETTER HERMÉTIQUE	HERMETISCHE MIXERSCHEIBE
WFP14S12	DISCO TRITURADOR RALLADOR REVERSIBLE	REVERSIBLE SHREDDING DISC	DISQUE À ÉMINCER RÉVERSIBLE	REVERSIBLE REIBE- UND MIXERSCHEIBE



WSBPPWE

BATIDOR BIG STIK / HEAVY-DUTY BIG STIK /
MIXEUR BIG STIK / STABMIXER

REF	DESCRIPCIÓN	DESCRIPTION	DESCRIPTION	BESCHREIBUNG
WSB01	GANCHO COLGADOR	WALL HOOK	CROCHET DE SUSPENSION	WANDHALTER
WSB2W	ACCESORIO BATIDOR	WHISK ATTACHMENT	BATTEURS	STABMIXERZUBEHÖR

ÍNDICE / INDEX / УКАЗАТЕЛЬ

ESPAÑOL

ARTÍCULO	PÁGINA
ABRELATAS INDUSTRIAL	78
ABRIDOR BOTELLAS	110
AFILADOR DE CUCHILLOS	209
ALCUZA	75
ALFOMBRAS	326-327
ALU-PRO	32-35
ANILLO ANTI-GOTEO	319
APARTAMENTO	106
APLASTACARNES	75
ARAÑA	61
ARMARIO CALIENTE	228-230
ARMARIO REFRIGERADOR BOTELLAS	233
ARO	385
ASADOR GRILL	95-97
AZUCARERO	321-323
BALANZA	83-84
BAMBÚ NATURAL & MADERA	280-281
BANDEJA	52-55, 145, 163-164, 272, 299-300, 300-305, 325, 352-354
BANDEJA ALUMINIO ANTIADHERENTE	53-54
BANDEJA AUTO-SERVICE ACERO INOX	353
BANDEJA CAMARERO	325
BANDEJA EXHIBICIÓN	303
BANDEJA FAST-FOOD	352
BANDEJA GASTRONORM	52
BANDEJA ISOTÉRMICA	354
BANDEJA OVAL	343
BANDEJA PARA MARISCOS	342
BANDEJA PASTELERÍA	375, 52-54
BANDEJA PORTACUBIERTOS	353, 252
BANDEJAS. CUBIC	243-245, 248-249, 251-252
BAÑO MARÍA	225-226, 274-275
BAÑO MARÍA GASTRONORM	225
BARRA DE NOTAS	75
BASE PIZZA	55
BATERÍA COCINA 8 PZAS HOBBY CHEF	105
BATERÍA IDEA	102-103
BATIDOR	366
BATIDORAS DE VASO	200-207
BATIDORAS PARA BATIDOS	208
BLACK SERIES	94-97
BOL	297-298, 298-300, 305-311, 310-311, 354
BOL ORIENTAL	311
BOQUILLA	391-394
BOQUILLA POLICARBONATO	394
BOTELLA BAR	325
BRAZOS TRITURADORES	196-198
BUFFET CUBIC. CARRO BUFFET	148-151

ARTÍCULO	PÁGINA
BUFFET CUBIC. CUBOS Y ESTANTES	236-237, 239-255
BUFFET CUBIC. MUEBLE EXPOSITOR	236-237, 256-260
CACEROLA ALUMINIO	33-34, 332
CACEROLA APARTAMENTO	106
CACEROLA COOL • LINE	101
CACEROLA HANDY	30
CACEROLA HOBBY CHEF	104
CACEROLA IDEA	103
CACEROLA INOX-PRO	24-25, 27
CACEROLA TOP LINE	18-19
CACILLO	58, 107-108, 264-269, 309
CAFETERA	321-323
CAJA CONDIMENTOS	318
CALDERO	364-365
CALENTADOR DE PLATOS	230-232
CAMPANA PARA POSTRES	372
CARRO BASCULANTE	157
CARRO CON GUIAS	157-166
CARRO CON GUIAS PARA HORNO	162
CARRO CON GUIAS, DESMONTABLE	158-163
CARRO CON GUIAS, ENCASTABLE	159-160
CARRO CON SUPERFÍCIE DE TRABAJO	165
CARRO DE MADERA	148-151
CARRO DE PLÁSTICO	152, 166-167
CARRO DE SERVICIO DESMONTABLE	154
CARRO DE SERVICIO EN ALUMINIO	152
CARRO DE SERVICIO INOXIDABLE	153-155
CARRO DESCONGELACIÓN	161
CARRO DESEMBARACE	155
CARRO DOBLE PARA BANDEJAS FAST-FOOD	163
CARRO GASTRONORM DESCONGELACIÓN	161
CARRO GUERIDON	150-151
CARRO PARA CARGAS PESADAS	165
CARRO PARA CESTAS	166
CARRO PARA PLATOS AJUSTABLE	167
CARRO PORTA CUBETAS GASTRONORM	157, 158, 161
CARRO PORTACUBIERTOS	151, 165, 352
CARTA DE VINOS	346
CASCANUECES	271
CAZO ALUMINIO	35
CAZO APARTAMENTO	106
CAZO BOMBEADO	21, 29, 31, 35, 99, 364
CAZO COOL • LINE	101
CAZO HANDY	31
CAZO HOBBY CHEF	105
CAZO IDEA	103
CAZO INOX-PRO	29

ARTÍCULO	PÁGINA
CAZO TIPO FRANCÉS.....	20, 29
CAZOS DE MEDIDAS	82
CAZUELA ALUMINIO FUNDICIÓN	96
CAZUELA BLACK SERIES	96
CAZUELA PUJADAS 1921.....	93
CEDAZO	373
CENICERO	344
CEPILLO.....	76
CESTA GRANDES BANDEJAS.....	145
CESTA PARA BANDEJAS ISOTÉRMICAS	145
CESTA PARA CUBIERTOS	142
CESTA UNIVERSAL.....	142
CESTAS ABIERTAS	138-139, 142
CESTAS CERRADAS	140-141
CESTAS PARA PLATOS.....	143-145
CESTAS POLIPROPILENO.....	282-289
CESTILLO PARA CUBIERTOS.....	142
CHAFING DISH	274-279
CINTA PVC PARA MOUSSE	385
CLIP DE IDENTIFICACIÓN.....	146
CO-COTTE SILICONA.....	112
COCTELERA.....	318
COLADOR.....	71-73
COLADOR BOLA INFUSIONES.....	324
COLADOR CHINO	70
COLADOR GUSANILLO.....	318
COLAPASTAS	27
COLECTIVIDADES.....	352-359
CONJUNTOS COMPLETOS DE ESTANTERIAS	174-185
CONJUNTOS. CUBIC.....	246-249
CONSUMIBLES.....	347-351
COOL • LINE.....	100-101
COPA HELADO.....	376
CORTACAPSULAS	319
CORTADOR / DESCORAZONADOR MANZANAS.....	110, 77-78
CORTADOR BOLAS.....	111
CORTADOR DE PATATAS FRITAS	77-78
CORTADOR DE VERDURAS.....	192
CORTADOR TOMATES	73
CORTADORA ELÉCTRICA DE FIAMBRES	192
CORTAHUEVOS.....	77
CORTAPASTAS.....	368, 384
CRÊPERA.....	227
CUADRADO BOMBEADO.....	387
CUBERTERO PARA CARRO SERVICIO.....	155
CUBETA GASTRONORM SIN BPA.....	109, 121, 130-131
CUBETAS HELADERÍA	377
CUBITERA DE PLÁSTICO	316
CUBITERA ENSALADERA	316
CUBITERA ISOTÉRMICA.....	315
CUBO CHAMPÁN.....	312-317
CUBO CON BASE.....	82
CUBO GALVANIZADO.....	315
CUBO HIELO	315
CUCHARA	60, 107-108, 409, 264-269, 309, 318
CUCHARA BATIDORA.....	318

ARTÍCULO	PÁGINA
CUCHARA PARA UNTAR	64, 66, 110
CUCHILLA/RODILLO DE RECAMBIO	78
CUCHILLO.....	265-267, 265-267
CUECE PASTAS.....	220
CUSCUSERA.....	26
DISPENSADOR A PRESIÓN	74
DISPENSADOR BOLSAS TE Y AZÚCAR. CUBIC	253
DISPENSADOR DE ZUMOS.....	279
DISPENSADOR LECHE.....	279
DISPENSADOR PAN	284
DISPENSADOR ZUMOS. CUBIC.....	250
DOSIFICADOR LICOR	318
ELEMENTO ELÉCTRICO CHAFING DISH.....	278
EMBUDO	74, 374
EMBUDO DOSIFICADOR	374
ENFRIADOR BOTELLAS BUFFET. CUBIC.....	265
ENFRIADOR ISOTÉRMICO.....	315-316
ENSALADERA ACRÍLICA.....	273
ESCAMADOR	76
ESCURRIDERA	71
ESPÁTULA.....	59, 107-108, 64, 264-269, 367
ESPECIEROS.....	74
ESPUMADERA.....	59, 61, 107-108, 264-269
ESTANTERÍAS.....	168-185
EXPOSITOR DE TARTAS	373
EXPOSITOR GASTRONORM	293-296
EXPOSITOR TRES NIVELES. CUBIC.....	250
EXPRIME LIMONES	318
EXPRIMIDOR.....	209
FLANERO.....	380, 387, 398
FLAP IDENTIFICACIÓN	146
FLAP-RACK®.....	136-147, 144-147
FONDOS PERFORADOS GASTRONORM.....	124-125, 129, 131, 161
FREIDORA.....	212-213
FUEL PARA CHAFING DISH	278
FUENTE DE PESCADO BORDE VUELTO.....	272
FUENTE FONDUE CHOCOLATE.....	226
FUENTE HONDA CÓNICA	356
FUENTE OVAL.....	272, 304-305
FUNDA PROTECTORA DE VINILO	167
FUNDAS DESECHABLES POLIETILENO DISPENSADOR.....	165
GANCHO.....	72, 356
GASTRONORM FONDO DIFUSOR	127
GASTRONORM INOXIDABLE.....	122-127
GASTRONORM MELAMINA.....	291-311
GASTRONORM POLICARBONATO	128-129
GASTRONORM POLIPROPILENO	132-133
GOFRERAS.....	227
GRILL	217-219
GUANTES PROTECCIÓN	86-87
HANDY	30-31
HARINERO	71
HELADERÍA.....	188-191, 376-377
HERVIDOR DE ARROZ	220
HOBBY CHEF.....	104-105
HORNOS.....	223

ARTÍCULO	PÁGINA
INOX-PRO	22-29
JARRA	339-340
JARRA DE MEDIDAS	82
JARRA PARA INFUSIONES	324
JARRA TERMO	339
JUEGO COCINA 5 PIEZAS	264
LÁMPARA MANTENEDORA	231-232
LAVA-RACIONADOR ACERO INOX	377
LECHERA	321-323
LIBRADOR	365
LICUADORAS	208
MANDOLINAS	73
MANGAS PASTELERAS	390
MANOPLA	86-87
MANTA ENFRIADORA	316
MANTECADORA	188-191
MANTELES INDIVIDUALES	328-329
MARCADOR DE TARTAS	370
MARCADORES TIZA	359
MARCOS PARA BANDEJAS	53
MELAMINA PRESENTACIÓN	290-311, 332
MESA DE CORTE	81
MESITA BUFFET. CUBIC	253, 261
MICRO-ONDAS	224
MINIATURAS ALUMINIO FUNDICIÓN	332
MINIATURAS HIERRO FUNDIDO	334-335
MINIATURAS INOX	330-331
MINIATURAS MELAMINA	332
MOLDE CAKE	398, 378, 388
MOLDE FORMA CORAZÓN	386
MOLDE FORMA GOTA	386
MOLDE FORMA LÁGRIMA	386
MOLDE HEXAGONAL	386
MOLDE HUEVO	75
MOLDE MEDIA CAÑA	388
MOLDE NIDO	61
MOLDE OVAL	386
MOLDE PARA PIZZA	55
MOLDE SEMIESFÉRICO	388
MOLDES "FLEXIPAN"	403-411
MOLDES DE SILICONA	395-402
MOLDES PARA CHOCOLATE	399
MOLDES PASTELERÍA	378-382, 385-388, 395-402, 403-411
MOLDES SILICONA 600 X 400	400-402
MOLINILLO ESPECIAS	210
MOLINILLO PIMIENTA	342
MOLINILLO SAL	342
MULTIMETAL	98-99
NÚMERO MESA	341
OLLA ALUMINIO	33-34
OLLA APARTAMENTO	106
OLLA CON GRIFO	27
OLLA COOL • LINE	100
OLLA ELÉCTRICA	279
OLLA HANDY	30
OLLA HOBBY CHEF	104

ARTÍCULO	PÁGINA
OLLA IDEA	103
OLLA INOX-PRO	24-25, 27
OLLA TOP LINE	18-19
PAELLERA ACERO ESMALTADO	48
PAELLERA ALUMINIO	43
PAELLERA HANDY	31
PAELLERA HOBBY CHEF	104
PAELLERA INOX-PRO	24-25
PAELLERA PUJADAS 1921	93
PAELLERA TOP LINE	18-19
PAELLERA VALENCIANA	48
PAELLERO ESMALTADO GAS	49
PALA CHIPS	63
PALA FAST-FOOD	64-66
PALA HELADOS	376
PALA PARA QUESO	110
PALA PASTELES	107-108, 64, 66, 110
PALA PESCADO	59, 109, 64-64
PALA PIZZA	56
PALA PRESENTACIÓN	291-292
PALILLOS	311
PANEL INFORMACIÓN	357
PANERA	284-285, 309
PAÑO SILICONA	87
PAPEL SILICONADO	56
PAPELERA SOBREMESA	344
PARRILLA PLANA CON ASAS ALUMINIO	97
PASAPURÉS	72
PEINE DECORADOR	370
PELADOR PATATAS	111
PELADOR UNIVERSAL	111
PERFILES DIVISORIOS	120, 123
PIE CON PORTACUBOS	317
PIE CUBITERA 3 BOTELLAS	317
PINCEL	109, 369
PINCHANOTAS	343
PINCHO / BROCHETA	343
PINCHOS. SOPORTE PRESENTACIÓN. CUBIC	244-245
PINZA	62-63, 107-109, 270-271, 318
PINZA ANILLAS	270
PINZA BUFFET	63, 270
PINZA CHARCUTERÍA	270-271
PINZA FUENTE HORNO	56
PINZA PARA MARISCO	271
PINZA REPOSTERÍA	270
PINZAS PARA EMPLATAR	62
PISTOLA REPOSTERIA	389
PIZARRAS	358-359
PIZARRAS PRESENTACIÓN	292, 336-337
PLACA "RESERVADO"	341
PLACA CALIENTE	232
PLACA ENFRIADORA	273
PLACA INDUCCIÓN	222
PLACA PROHIBIDO FUMAR	341
PLANCHA ELÉCTRICA	219
PLANTILLA CORTA-RODAJAS	111

ARTÍCULO	PÁGINA
PLATILLO CAMBIO	346
PLATOS	298-299, 303, 308-311, 354
PORTA BROCHETAS	343
PORTA CUBIERTOS	151, 155, 165, 252, 289, 352
PORTAMENÚS	346
PORTASALADOS / PORTASALSAS	342
PORTATARJETAS	346
POSTE SEPARACIÓN	356-357
PRENSA AJOS	111, 77
PRESENTADOR BOLS MELAMINA. CUBIC	242-247, 255
PRESENTADOR CUBETAS GN	126, 296
PROCESADOR DE ALIMENTOS	191-195
PUJADAS 1921. HIERRO DE FUNDICIÓN ULTRALIGERO INDUCCIÓN..	92-93
QUEMADOR ELÉCTRICO	372
QUEMADOR INDUSTRIAL	49
RACIONADOR DE HELADO	376
RALLADOR	67-68, 110
RASQUETA	64-66, 76, 370
RECIPIENTE PARA SALSAS	308
RECOGEMIGAS	341
RECOGEVERDURAS	81
REJILLAS GN	54
REJILLAS PASTELERÍA	54, 375
RELOJ DE COCINA DIGITAL	84
REMO	76
RODILLO	369
RULETA CORTAPIZZAS	64
RUSTIDERA	51, 96-97, 99
SACACORCHOS	319
SALAMANDRA	220
SALSERA	342
SARTÉN "LIONESA"	47
SARTÉN ACERO INOXIDABLE	46
SARTÉN ALUMINIO	42-44, 106
SARTÉN ALUMINIO FUNDICIÓN	95-97
SARTÉN BLACK SERIES	95, 97
SARTÉN CRÊPES	44, 47, 97
SARTÉN HONDA ESMALTADA CON ASAS	48
SARTÉN IDEA	103
SARTÉN MULTIMETAL	99
SARTÉN PARA BLINIS	44
SARTÉN PUJADAS 1921	93
SARTENES	38-49, 93, 95, 99, 106
SAUTEX ALUMINIO	35
SAUTEX HANDY	31
SAUTEX HOBBY CHEF	105
SAUTEX INOX-PRO	28
SAUTEX MULTIMETAL	99
SEPARADOR PARA OLLA CON GRIFO	27
SERVILLETERO	345
SERVILLETERO. CUBIC	253
SIERRA DE COCINA	66, 76
SOPERA	272
SOPLATE COCINA	372
SOPORTE CUCURUCHO	376

ARTÍCULO	PÁGINA
SOPORTE MÁRMOL EXHIBICIÓN	292
SOPORTE MESA BANDEJA MARISCO	342
SOPORTE PARA BANDEJAS DE GRAN TAMAÑO	343
SOPORTE PARA BANDEJAS PORTACUBIERTOS GN	353
SOPORTE PARA CHINO O EMBUDO	70, 374
SOPORTE PARA CUBO CHAMPÁN	316
SOPORTE PARA MANGAS PASTELERAS	390
SOPORTE PARA NÚMEROS	341
SOPORTE PARA PINCHOS. CUBIC	244-245
SOPORTE PARA PIZZAS	56
SOPORTE PARA TABLAS DE CORTE	126
SOPORTE PARED (UTENSILIOS) 5 GANCHOS	265-268
SOPORTE PRESENTACIÓN PIZARRA-MÁRMOL	292
SOPORTE TAPAS GN	126
TABLA DE CORTE	80-81
TAPA BATERIA	21, 27, 31, 35, 105
TAPA GN	121, 125, 129, 131, 132, 133
TAPA INOX-PRO	27
TAPA PARA CESTA	142
TAPA POLINORM®	121, 125, 129, 131, 132
TAPA RÍGIDA PARA FUENTE RECTANGULAR	354
TAPA TAZA DESAYUNO	354
TAPETE DE SILICONA	56
TAPÓN CHAMPÁN	319
TAPÓN UNIVERSAL	319
TAZA	309-310, 354
TENEDOR	60, 107, 66, 76, 264-269
TERMO CON DOSIFICADOR	339
TERMÓMETRO	84-85
TETERA	321-324
TOP LINE	18-21
TOSTADORA	214-217
TRIÁNGULO BOMBEADO	384
TRÍPODE PAELLERO	49
TRITURADOR DE HIELO	210
UTENSILIOS MANGO MADERA	64-65
VAPORERA COOL • LINE	101
VAPORERA HOBBY CHEF	105
VAPORERA INOX-PRO	26
VASO	355
VERSATIL MACHINE	78
VITRINAS PRESENTACIÓN	263
WOK ACERO	47
WOK BLACK SERIES	95
WOK INOX	46
WOK MULTIMETAL	99
WOK PUJADAS 1921	93

ENGLISH

ITEM	PAGE
ADAPTABLE BARS	120, 123
ADJUSTABLE DISH CADDY	167
AIR POT	339
ALU-PRO	32-35
APARTAMENTO	106
APPLE CORER	110, 77-78
ASHTRAY	344
BAIN MARIE	225-226, 274-275
BAIN-MARIE GASTRONORM	225
BAR KEEP	325
BARRIER	356-357
BASE FOR BURNER	49
BILL HOLDER	346
BILL SPIKE	343
BIRD NEST MOULD	61
BLACK SERIES	94-97
BLACK STEEL SPANISH PAELLA PAN	48
BLACKBOARDS	358-359
BLENDERS	200-207
BOILER	364-365
BOTTLE OPENER	110
BOWL	297-298, 298-300, 305-311, 310-311, 354
BPA FREE GASTRONORM PAN	109, 121, 130-131
BREAD BASKET	284-285, 309
BREAD DISPENSER	284
BRUSH	76
BRUSH	109, 369
BUCKET WITH BASE	82
BUCKET-HOLDER STAND	317
BUCKET-HOLDER STAND	316
BUFFET CUBIC. BUFFET TROLLEY	148-151
BUFFET CUBIC. CUBES & SHELVES	236-237, 239-255
BUFFET CUBIC. DISPLAY CASE	236-237, 256-260
BUFFET FUEL	278
BUFFET WINE COOLER. CUBIC	265
BURNER	49
BUTTER SPREADER	64, 66, 110
CAKE DIVIDER	370
CAKE MOULD	398, 378, 388
CAKE SERVER	107-108, 64, 66, 110
CAKE STAND	373
CAN OPENER	78
CARAMEL CREAM MOULD	380, 387, 398
CARAMELIZER	372
CARD HOLDER	346
CARRY-SKEWERS	343
CASSEROLE	96
CASSEROLE BLACK SERIES	96
CASSEROLE PUJADAS 1921	93
CAST IRON MINIATURE	334-335
CHAFING DISH	274-279
CHALKMARKERS	359
CHAMPAGNE BUCKET	312-317
CHAMPAGNE STOPPER	319
CHECK MINDER	75
CHEESE SLICER	110

ITEM	PAGE
CHINESE COLANDER	70
CHIP BAGGER	63
CHOCOLATE FOUNTAIN	226
CHOPSTICK	311
CLEARING TROLLEY	155
CLIMATISATION CABINET BOR WINE BOTTLES	233
CLIP TAGS	146
COCKTAIL SPOON	318
COCKTAIL STRAINER	318
CO-COTTE SILICONE	112
COFFE MAKER	324
COFFE POT	321-323
COLANDER	71-73
COLANDER	71
COMPLETE KITS OF SHELVING	174-185
CONDIMENT HOLDER	318
CONFECTIONERY FUNNEL	374
CONICAL SAUCEPAN	21, 29, 31, 35, 99, 364
COOL • LINE	100-101
COOLING PLATE	273
CORKSCREW	319
CORNET STAND	376
COUNTER-TOP DISPENSER	151, 165, 352
COUSCUS SET	26
CREAMER	321-323
CRÊPE MAKER	227
CUP	309-310, 354
CUTLERY BIN	353, 252
CUTLERY DISPENSER FOR SERVING TROLLEY	155
CUTTING BOARD	80-81
CUTTING BOARD TABLE	81
DECORATING COMB	370
DESSERT COVER	372
DISHES	298-299, 303, 308-311, 354
DISPLAY CABINET	263
DISPLAY PLATE	303
DISPLAY SLATES	292, 336-337
DISPLAYER MELAMINE BOWLS. CUBIC	242-247, 255
DISPOSABLE COVER	165
DISPOSABLES	347-351
DOUBLE COUNTER-TOP CUTLERY DISPENSER GN	353
DOUBLE CUTTER	368, 384
DOUBLE FAST-FOOD TRAY TROLLEY	163
DOUBLE WALL ICE PAIL	315
DOUBLE WALL INSULATED COOLER	315-316
DREGDERS	74
DRINK MIXERS	208
DROP MOULD	386
EGG RING	75
EGG SLICER	77
ELECTRIC HEATING UNIT FOR CHAFING DISH	278
ELECTRIC SLICING MACHINE	192
ENAMELLED GAS BURNIER	49
ENAMELLED STEEL PAELLA PAN	48
FAST-FOOD TURNER	64-66
FISH SCALER	76

ITEM	PAGE
FISH TRAY	272
FISH TURNER	59, 109, 64-64
FLAP IDENTIFICATION	146
FLAP-RACK®	136-147, 144-147
FLATWARE BASKET	142
FLOUR BIN	71
FOIL CUTTER	319
FOOD-PROCESSORS	191-195
FORK	60, 107, 66, 76, 264-269
FRENCH FRY CUTTER	77-78
FRENCH STYLE SAUCEPAN	20, 29
FRY PAN "LYONNAISE"	47
FRY PAN ALUMINIUM	42-44, 106
FRY PAN BLACK SERIES	95, 97
FRY PAN BLINIS	44
FRY PAN CAST ALUMINIUM	95-97
FRY PAN CRÊPE	44, 47, 97
FRY PAN DEEP ENAMELLED WITH HANDLES	48
FRY PAN IDEA	103
FRY PAN MULTIMETAL	99
FRY PAN PUJADAS 1921	93
FRY PAN ST/STEEL	46
FRY PANS	38-49, 93, 95, 99, 106
FRYER	212-213
FUNNEL	74, 374
GALVANIZED BUCKET	315
GARLIC PRESS	111, 77
GASTRONORM CONTAINERS (MELAMINE)	291-311
GASTRONORM CONTAINERS (POLYCARBONATE)	128-129
GASTRONORM CONTAINERS (POLYPROPYLENE)	132-133
GASTRONORM FOR DEFROST TROLLEY	161
GASTRONORM SANDWICH BOTTOM	127
GASTRONORM ST/STEEL	122-127
GASTRONORM STAND	293-296
GLASS	355
GLOVES	86-87
GN TRANSPORT TROLLEY	157, 158, 161
GRANITE-SLATE DISPLAYER	292
GRATER	67-68, 110
GRAVY BOAT	342
GRID FOR STOCK POT WITH TAP	27
GRID GN	54
GRID PASTRY	54, 375
GRIGGLE	219
GRILL	95-97
GRILL	217-219
GRINDER (ELECTRIC)	210
HANDY	30-31
HEART RING MOULD	386
HEATING PLATE	232
HEMISPHERICALD MOULD	388
HEXAGON MOULD	386
HOBBY CHEF	104-105
HOOK	72, 356
HOT CUPBOARD	228-230
HOT TRAY WARMER	230-232

ITEM	PAGE
HOT-PLATE WITH HANDLES	97
ICE BUCKET	315
ICE CREAM CONTAINERS	377
ICE CREAM CUP	376
ICE CREAM SCOOP	376
ICE CREAM SPATULA	376
ICE CRUSHER	210
ICE CUBE BOWL	316
ICE-CREAM CHURN	188-191
ICE-CREAM PARLOUR	188-191, 376-377
IDEA COOKWARE	102-103
INDUCTION COOKER	222
INFORMATION SIGN	357
INOX-PRO	22-29
INSTITUTIONS	352-359
INSULATED COFFE POT	339
ISOTHERMAL TRAY	354
JIGGER	318
JUICE DISPENSER	279
JUICE DISPENSER. CUBIC	250
JUICE EXTRACTORS	208
KITCHEN BOW SAW	66, 76
KITCHEN BOWL	356
KITCHEN TIMER ALARM	84
KITCHEN TOOL SET (5 PCS)	264
KITCHENWARE SET 8 PCS HOBBY CHEF	105
KITS. CUBIC	246-249
KNIFE	265-267, 265-267
KNIFE SHARPENER	209
KNIFE / WHEEL (SPARE PART)	78
LADLE	58, 107-108, 264-269, 309
LAMP	231-232
LARGE TRAY HOLDER	343
LEMON SQUEEZER	318
LID FOR BREAKFAST CUP	354
LID FOR COOKWARE	21, 27, 31, 35, 105
LID GN	121, 125, 129, 131, 132, 133
LID INOX-PRO	27
LID RACKS	142
LOBSTER CRACKER	271
MANDOLINES	73
MARBLE OBLONG DISPLAY PLATE	292
MATS	326-327
MEASURING CUPS	82
MEASURING JUG	82
MEAT BEATER	75
MELAMINE FOR PRESENTATION	290-311, 332
MELAMINE MINIATURES	332
MELON BALLER	111
MENU HOLDER	346
MICRO-WAVES	224
MILK DISPENSER	279
MINIATURE CAST ALUMINIUM	332
MIXING PADDLE	76
MOULDS "FLEXIPAN"	403-411
MOULDS POUR CHOCOLAT	399

ITEM	PAGE
MULTIMETAL	98-99
NAPKIN HOLDER	345
NAPKIN HOLDER. CUBIC	253
NATURAL BAMBOO & WOOD	280-281
NON-SMOKING SING	341
NON-STICK SILICONE MAT	56
NUMBER CARD HOLDER	341
NUT CRACKER	271
OIL POURER	75
ONION FORK	111
ORIENTAL BOWL	311
OVAL MOULD	386
OVAL SERVING DISH	272, 304-305
OVAL SERVING TRAY	343
OVEN MITT	86-87
OVENS	223
PAELLA PAN ALUMINIUM	43
PAELLA PAN HANDY	31
PAELLA PAN HOBBY CHEF	104
PAELLA PAN INOX-PRO ST/STEEL	24-25
PAELLA PAN PUJADAS 1921	93
PAELLA PAN TOP LINE	18-19
PASTA COLANDER	27
PASTA COOKER	220
PASTRY BAGS	390
PASTRY MOULDS	378-382, 385-388, 395-402, 403-411
PASTRY TORCH	372
PELLER	111
PEPPER MILL	342
PERFORATED BOTTOMS GASTRONORM	124-125, 129, 131, 161
PIZZA MOULD	55
PIZZA PAN	55
PIZZA PAN RACK	56
PIZZA PEEL	56
PIZZA WHEEL	64
PLACE MATS	328-329
PLASTIC CHAMPAGNE BUCKET	316
PLATING TONGS	62
POLINORM® LID	121, 125, 129, 131, 132
POLYCARBONATE TUBE	394
POLYPROPYLENE BASKETS	282-289
POTATO PEELER	111
POT-GRABBER	87
PRESS CUM ICING	389
PUJADAS 1921. ULTRALIGHT WEIGHT CAST IRON INDUCTION	92-93
PVC RIBBON	385
RACK (BIG TRAYS)	145
RACK (CLOSED SYSTEM)	140-141
RACK (DISHES)	143-145
RACK (FLATWARE)	142
RACK (ISOTHERMAL TRAYS)	145
RACK (OPENED SYSTEM)	138-139, 142
RACK (UNIVERSAL)	142
RACK UTENSILS (5 HOOKS)	265-268
RAMEKIN	308
RECTANGLE FOR BAKING SHEETS	53

ITEM	PAGE
RICE COOKER	220
RIGID COVER FOR RECTANGULAR BOWL	354
RING	385
RING STOP DROP	319
ROAST PAN	51, 96-97, 99
ROLLING PIN	369
SALAD BOWL	273
SALAMANDER	220
SALT MILL	342
SAUCE PAN ALUMINIUM	35
SAUCE PAN APARTAMENTO	106
SAUCE PAN COOL • LINE	101
SAUCE PAN HANDY	31
SAUCE PAN HOBBY CHEF	105
SAUCE PAN IDEA	103
SAUCE PAN INOX-PRO ST/STEEL	29
SAUCE POT ALUMINIUM	33-34, 332
SAUCE POT APARTAMENTO	106
SAUCE POT COOL • LINE	101
SAUCE POT HANDY	30
SAUCE POT HOBBY CHEF	104
SAUCE POT IDEA	103
SAUCE POT ST/STEEL INOX-PRO	24-25, 27
SAUCE POT TOP LINE	18-19
SAUTÉ PAN ALUMINIUM	35
SAUTÉ PAN HANDY	31
SAUTÉ PAN HOBBY CHEF	105
SAUTÉ PAN INOX-PRO	28
SAUTÉ PAN MULTIMETAL	99
SCALE	83-84
SCOOP	365
SCRAPER	64-66, 76, 370
SERVER	339-340
SERVING PADDLE	291-292
SERVING TRAY	325
SERVING TRAY. CUBIC	243-245, 248-249, 251-252
SHAKER	318
SHELVING	168-185
SIEVES	373
SILICONE MOULDS	395-402
SILICONE MOULDS 600 X 400	400-402
SILICONIZED BAKING PAPERS	56
SKEVER	343
SKEWER SERVING SUPPORT. CUBIC	244-245
SKEWER SUPPORT. CUBIC	244-245
SKIMMER	59, 61, 107-108, 264-269
SNACK BOWL SET	342
SOUP KETTLE	279
SOUP TOUREEN	272
SPATULA	59, 107-108, 64, 264-269, 367
SPOON	60, 107-108, 409, 264-269, 309, 318
SQUARE MOULD	387
SQUEEZER	209
SQUEZZE DISPENSER	74
ST/STEEL MINIATURES	330-331
ST/STEEL SCOOP WASHER	377

ITEM	PAGE
ST/STEEL SELF-SERVICE TRAY	353
STAND BUCKET	317
STAND FOR CHINESE COLANDER OR FUNN	70, 374
STAND FOR CUTTING BOARDS	126
STAND FOR GN CONTAINERS	126, 296
STAND FOR GN LIDS	126
STAND FOR SEA FOOD TRAY	342
STEAM POT COOL • LINE	101
STEAM POT HOBBY CHEF	105
STEAM POT INOX-PRO	26
STICK BLENDERS	196-198
STOCK POT ALUMINIUM	33-34
STOCK POT APARTAMENTO	106
STOCK POT COOL • LINE	100
STOCK POT HANDY	30
STOCK POT HOBBY CHEF	104
STOCK POT IDEA	103
STOCK POT INOX-PRO	24-25, 27
STOCK POT TOP LINE ST/STEEL	18-19
STOCK POT WITH TAP	27
SUGAR BOWL	321-323
SUPPORT FOR CUTLERY DISPENSER	151, 155, 165, 252, 289, 352
SUPPORT FOR PASTRY BAGS	390
TABLE CRUMBER	341
TABLE NUMBER	341
TABLE SING "RESERVED"	341
TABLE-TIDY	344
TEA INFUSION MESH	324
TEA POT	321-324
TEA&SUGAR BAGS DISPENSER. CUBIC	253
TEAR MOULD	386
THERMOMETER	84-85
THREE LEVELS STAND. CUBIC	250
TOASTER	214-217
TOMATOES SLICER	73
TONG	62-63, 107-109, 270-271, 318
TONG WITH RINGS	270
TONG. BUTCHER'S	270-271
TONG. CAKE	270
TONG. ROAST PAN	56
TONG. UTILITY	63, 270
TOP LINE	18-21
TRAY	52-55, 145, 163-164, 272, 299-300, 300-305, 325, 352-354
TRAY (FAST-FOOD)	352
TRAY (GASTRONORM)	52
TRAY (NON-STICK ALUMINIUM)	53-54
TRAY (PASTRY)	375, 52-54
TRAY (SEA FOOD)	342
TRIANGLE CAKE MOULD	388
TRIANGLE MOULD	384
TROLLEY (ALUMINIUM SERVING)	152
TROLLEY (DEFROST WITH RAIL)	161
TROLLEY (DISASSEMBLED SERVING TROLLEY)	154
TROLLEY (DISASSEMBLED WITH RAIL)	158-163
TROLLEY (GUERIDON)	150-151
TROLLEY (INOX SERVING)	153-155

ITEM	PAGE
TROLLEY (OVEN TRAY)	162
TROLLEY (PLASTIC)	152, 166-167
TROLLEY (RAIL)	157-166
TROLLEY (STACKABLE)	159-160
TROLLEY (SWINGING BEAM)	157
TROLLEY (WOODEN)	148-151
TROLLEY FOR DISHWASER RACKS	166
TROLLEY FOR HEAVY LOADS	165
TROLLEY WITH WORKING TOP	165
TUBE	391-394
UNIVERSAL STOPPER	319
VEGETABLE CUTTER	192
VEGETABLE SCRAPER	81
VEGETABLE SIEVE	72
VERSATIL MACHINE	78
VINYL RACK COVER	167
WAFFLES MAKER	227
WHISK	366
WINE CARD	346
WINE COOLER	316
WIRE SKIMMER	61
WOK (ST/STEEL)	46
WOK BLAC SERIES	95
WOK MULTIMETAL	99
WOK PUJADAS 1921	93
WOK STEEL	47
WOOD HANDLE UTENSILS	64-65
WOODEN TABLE. CUBIC	253, 261

FRANÇAIS

ARTICLE	PAGE
AIGUISEUR ÉLECTRIQUE.....	209
ALU-PRO.....	32-35
APARTAMENTO.....	106
APLATISSEUR.....	75
ARAIGNÉE.....	61
ARDOISES PRÉSENTATION.....	292, 336-337
ARMOIRE CHAUD.....	228-230
ARMOIRES CLIMATISATION À VIN.....	233
ASSIETTES.....	298-299, 303, 308-311, 354
BAC GASTRONORME SANS BPA.....	109, 121, 130-131
BAGUETTES.....	311
BAIN-MARIE.....	225-226, 274-275
BAIN-MARIE GASTRONORME.....	225
BALANCE.....	83-84
BAMBOU NATUREL & BOIS.....	280-281
BARRE PORTE-BONS.....	75
BARRETES DE COMPOSITION.....	120, 123
BASSINE.....	364-365
BASSINE PÂTISSIÈRE.....	356
BATTERIE DE CUISINE 8 PIÈCES HOBBY CHEF.....	105
BATTERIE IDEA.....	102-103
BLACK SERIES.....	94-97
BLENDERS.....	200-207
BOÎTE À CONDIMENT.....	318
BOL.....	297-298, 298-300, 305-311, 310-311, 354
BOL ORIENTAL.....	311
BOL POUR SNACKS.....	342
BOUCHON À CHAMPAGNE.....	319
BOUCHON UNIVERSEL.....	319
BOUEILLE DE BAR.....	325
BROCHETTE.....	343
BROSSE.....	76
BROYEUR À GLACE.....	210
BRÛLER ÉMAILLÉ.....	49
BRÛLEUR INDUSTRIEL.....	49
BUFFET CUBIC. CHARIOT BUFFET.....	148-151
BUFFET CUBIC. CUBES ET TABLETTES.....	236-237, 239-255
BUFFET CUBIC. MEUBLE PRÉSENTOIR.....	236-237, 256-260
CAFETIÈRE.....	321-323
CANNETTE ISOLANTE.....	339
CARAMÉLISER.....	372
CARTE DES VINS.....	346
CASSE-NOIX.....	271
CASSE-PATTES.....	271
CASSEROLE ALUMINIUM.....	35
CASSEROLE APARTAMENTO.....	106
CASSEROLE BOMBÉE.....	21, 29, 31, 35, 99, 364
CASSEROLE COOL • LINE.....	101
CASSEROLE FORME FRANÇAISE.....	20, 29
CASSEROLE HANDY.....	31
CASSEROLE HOBBY CHEF.....	105
CASSEROLE IDEA.....	103
CASSEROLE INOX-PRO.....	29
CASSEROLES DOSEUR.....	82
CENDRIER.....	344
CENTRIFUGEUSES.....	208

ARTICLE	PAGE
CERCLE.....	385
CHAFING DISH.....	274-279
CHARIOT À CHARGES LOURDES.....	165
CHARIOT À DÉGIVRAGE.....	161
CHARIOT À GLISSIÈRES.....	157-166
CHARIOT À GLISSIÈRES POUR FOUR.....	162
CHARIOT À GLISSIÈRES, DÉMONTABLE.....	158-163
CHARIOT À GLISSIÈRES, EMBOÎTABLE.....	159-160
CHARIOT À PLASTIQUE.....	152, 166-167
CHARIOT AJUSTABLE.....	167
CHARIOT AVEC PLAN DE TREVALL.....	165
CHARIOT BASCULANTE.....	157
CHARIOT DE DÉBARASSAGE.....	155
CHARIOT DE SERVICE DÉMONTABLE.....	154
CHARIOT DE SERVICE EN ALUMINIUM.....	152
CHARIOT DOUBLE POUR PLATEAUX FAST-FOOD.....	163
CHARIOT EN BOIS.....	148-151
CHARIOT GUERIDON.....	150-151
CHARIOT POUR PANIERS À VAISSELLE.....	166
CHARIOT TRANSPORT BAC GN.....	157, 158, 161
CHARIOTS DE SERVICE INOXYDABLE.....	153-155
CHINOIS À GAZE.....	70
CLIP D'IDENTIFICATION.....	146
COCOTTE.....	96
COCOTTE BLACK SERIES.....	96
CO-COTTE SILICONE.....	112
COCOTTES FONTE ALUMINIUM.....	332
COLLECTIVITÉS.....	352-359
CONTENEUR POUR SERVIETTES.....	345
COOL • LINE.....	100-101
CORBEILLE À PAIN.....	284-285, 309
CORBEILLES POLYPROPYLÈNE.....	282-289
CORPS DE CHAUFFE POUR CHAFING DISH.....	278
COUPE À GLACE.....	376
COUPE FRITES.....	77-78
COUPE TOMATES.....	73
COUPE-CAPSULES.....	319
COUPE-LÉGUMES.....	192
COUPE-OEUF.....	77
COUSCOUSSIER.....	26
COUTEAU.....	265-267, 265-267
COUTEAU / ROULEAU (PIÈCE DE RECHNGE).....	78
COUTEAU À BEURRE.....	64, 66, 110
COUTEUA À BEURRE.....	110
COUVERCLE À DESSERT.....	372
COUVERCLE BATTERIE.....	21, 27, 31, 35, 105
COUVERCLE GN.....	121, 125, 129, 131, 132, 133
COUVERCLE INOX-PRO.....	27
COUVERCLE POLINORM®.....	121, 125, 129, 131, 132
COUVERCLE POUR COUPELLE DESSERT.....	354
COUVERCLE POUR PANIER.....	142
COUVERCLE RIGIDE POUR RAVIER CARRÉ.....	354
CREMIÈRE.....	321-323
CRÉPIÈRE.....	227
CROCHET.....	72, 356
CUILLÈR À POMMES.....	111

ARTICLE	PAGE
CUILLÈRE	60, 107-108, 409, 264-269, 309, 318
CUILLÈRE À COCKTAIL	318
CUILLÈRE À GLACE	376
CUISER À PÂTE	220
CUISEUR À RIZ	220
CUIT-PÂTES	27
CUIT-VAPEUR COOL • LINE	101
CUIT-VAPEUR HOBBY CHEF	105
CUIT-VAPEUR INOX-PRO	26
DEMI-SPÉRIQUE	388
DISTRIBUER À JUS	279
DISTRIBUTEUR À JUS. CUBIC	250
DISTRIBUTEUR À LAIT	279
DISTRIBUTEUR À PRESSION	74
DISTRIBUTEUR DES SAQUETTES THÉ & SUCRE. CUBIC	253
DISTRIBUTEUR SERVIETTES. CUBIC	253
DOUILLE	391-394
ECAILEUR	76
ECUMOIRE	59, 61, 107-108, 264-269
EGOUTTOIRS POUR BACS GASTRONORME	124-125, 129, 131, 161
ENTONNOIR	74, 374
ENTONNOIR DOSEUR	374
EPINGLE PORTE-TICKETS	343
EPLUCHEUR	111
EPLUCHEUR UNIVERSEL	111
ETAGÈRES	168-185
FAITOUT ALUMINIUM	33-34, 332
FAITOUT APARTAMENTO	106
FAITOUT COOL • LINE	101
FAITOUT HANDY	30
FAITOUT HOBBY CHEF	104
FAITOUT IDEA	103
FAITOUT INOX-PRO	24-25, 27
FAITOUT PUJADAS 1921	93
FAITOUT TOP LINE	18-19
FLAP IDENTIFICATION	146
FLAP-RACK®	136-147, 144-147
FONTAIN À CHOCOLAT	226
FOUET	366
FOUR À MICRO-ONDES	224
FOURCHETTE	60, 107, 66, 76, 264-269
FOURCHETTE À ONGIONS	111
FOURS	223
FRITEUSE	212-213
FUEL POR CHAFING DISH	278
GANT À FOUR	86-87
GANTS	86-87
GASTRONORME POUR CHARIOT DÉGIVRAGE	161
GASTRONORM INOXYDABLE	122-127
GASTRONORME (MELAMINE)	291-311
GASTRONORME (POLYCARBONATE)	128-129
GASTRONORME (POLYPROPYLENE)	132-133
GASTRONORME AVEC FOND THERMO-DIFFUSEUR	127
GAUFFRIERS	227
GLACES	188-191, 376-377
GOUTTIÈRE	388

ARTICLE	PAGE
GRILL	95-97
GRILL	217-219
GRILL PLAT AVEC POIGNÉES	97
GRILLE GN	54
GRILLE PÂTISSERIE	54, 375
GRILLE POUR MARMITE AVEC ROBINET	27
HANDY	30-31
HOBBY CHEF	104-105
HOUSSE JETABLES	165
HUCHE À PAIN	284
HUILIÈRE	75
INFUSER À THÉ	324
INOX-PRO	22-29
JETABLES	347-351
KITS PRÉPARÉS DE ÉTEGÈRE	174-185
KITS. CUBIC	246-249
LAMPE CHAUFFANTE	231-232
LOT CUISINE (5 PIÈCES)	264
LOUCHE	58, 107-108, 264-269, 309
MANDOLINES	73
MARMITE ALUMINIUM	33-34
MARMITE APARTAMENTO	106
MARMITE BUFFET	279
MARMITE COOL • LINE	100
MARMITE HOBBY CHEF	104
MARMITE INOX-PRO	24-25, 27
MARMITE TOP LINE	18-19
MARMITE TRAITEUR AVEC ROBINET	27
MARMITE TRAITEUR HANDY	30
MARMITE TRAITEUR IDEA	103
MARQUEURS	359
MELAMINE POUR PRÉSENTATION	290-311, 332
MESURE À COCKTAIL	318
MINIATURE FONTE ÉMAILLÉE	334-335
MINIATURES INOX	330-331
MINIATURES MÉLAMINE	332
MINUTEUR DE CUISINE	84
MIXEURS	196-198
MOULE À CAKE	398, 378, 388
MOULE À FLAN	380, 387, 398
MOULE À NID	61
MOULE À OEUF	75
MOULE À PIZZA	55
MOULE CARRÉ	387
MOULE COEUR	386
MOULE GOUTTE	386
MOULE HEXAGONE	386
MOULE LARME	386
MOULE OVALE	386
MOULE TRIANGLE	384
MOULES "FLEXIPAN"	403-411
MOULES À SILICONE 600 X 400	400-402
MOULES DE SILICONE	395-402
MOULES PÂTISSERIE	378-382, 385-388, 395-402, 403-411
MOULES POUR CHOCOLATES	399
MOULIN À ÉPICES	210

FRANÇAIS

ARTICLE	PAGE
MOULIN À LÉGUMES	72
MOULINS À POIVRE	342
MOULINS À SEL	342
MULTIMÉTAL	98-99
NUMÉRO DE TABLE	341
OUVRE BOUTEILLES	110
OUVRE-BOÎTES	78
PALETTE	59, 107-108, 64, 264-269, 367
PALETTE À FISH	59, 109, 64-64
PALETTE FAST-FOOD	64-66
PANIER FERMÉES	138-139, 142
PANIER OUVERTS	140-141
PANIER POUR ASSITTES	143-145
PANIER POUR COUVERTS	142
PANIER POUR PLATEAUX	145
PANIER POUR PLATEAUX ISOTHERMES	145
PANIER UNIVERSEL	142
PANNEAU INFORMATION	357
PAPIER SILICONE	56
PASSOIRE À COCKTAIL	318
PASSOIRE À POIGNÉES	71
PASSOIRE À QUEUE	71-73
PEIGNE À DECOR	370
PELLE À ENFOURNER	56
PELLE À FARINE	365
PELLE À FRITES	63
PELLE À GÂTEAU	107-108, 64, 66, 110
PELLE À GLACE	376
PELLE À LÉGUMES	81
PELLE PRÉSENTATION	291-292
PETIT PANIER POUR LES COUVERTS	142
PICHET	339-340
PIE AVEC BASQUE	317
PIED PORTE-SEAUX	317
PIED POUR BRÛLEUR	49
PINCE	62-63, 107-109, 270-271, 318
PINCE À ANNEAUX	270
PINCE À GÂTEAU	270
PINCE À VIANDE	270-271
PINCE BUFFET	63, 270
PINCE POUR PLAQUE À RÔTIR	56
PINCEAU	109, 369
PINCES POUR PRÉSENTATION	62
PIQUES SUPPORT PRÉSENTATION. CUBIC	244-245
PISTOLET POUR PÂTISSERIE	389
PLANCHE À DÉCOUPER	80-81
PLAQUE "DÉFENSE DE FUMER"	341
PLAQUE "RESERVÉ"	341
PLAQUE À INDUCTION	222
PLAQUE À PÂTISSERIE	375, 52-54
PLAQUE À PIZZA	55
PLAQUE À RÔTIR	51, 96-97, 99
PLAQUE ALUMINIUM ANTI-ADHESIF	53-54
PLAQUE CHAUFFANTE	232
PLAQUE ÉLECTRIQUE	219
PLAQUE GASTRONORME	52

ARTICLE	PAGE
PLAQUE RÉFRIGÉRANTE	273
PLAT À PAELLA ACIER ÉMAILLÉ	48
PLAT À PAELLA ALUMINIUM	43
PLAT À PAELLA EN TÔLE ACIER	48
PLAT À PAELLA HANDY	31
PLAT À PAELLA HOBBY CHEF	104
PLAT À PAELLA INOX-PRO	24-25
PLAT À PAELLA PUJADAS 1921	93
PLAT À PAELLA TOP LINE	18-19
PLAT À POISSON	272
PLAT OVALE	272, 304-305
PLATEAU	52-55, 145, 163-164, 272, 299-300, 300-305, 325, 352-354
PLATEAU	325
PLATEAU À FRUITS DE MER	342
PLATEAU FAST-FOOD	352
PLATEAU FORME OVALE	343
PLATEAU ISHOTHERMIC	354
PLATEAU MARBRES NOIR	292
PLATEAU PRÉSENTATION	303
PLATEAU PRÉSENTATION. CUBIC	243-245, 248-249, 251-252
PLATEAU SELF-SERVICE ACIER INOX	353
POCHES PÂTISSIÈRES	390
POÊLE "LYONNAISE"	47
POÊLE À BLINIS	44
POÊLE À CRÊPES	44, 47, 97
POÊLE ACIER INOXYDABLE	46
POÊLE ALUMINIUM	42-44, 106
POÊLE ALUMINIUM FONTÉ	95-97
POÊLE BLACK SERIES	95, 97
POÊLE HAUTE AVEC ANSES	48
POÊLE IDEA	103
POÊLE MULTIMÉTAL	99
POÊLE PUJADAS 1921	93
POÊLES	38-49, 93, 95, 99, 106
POLUCARBONATE DOUILLE	394
PORTE-ADDITION	346
PORTE-BROCHETTES	343
PORTE-CARTES	346
PORTE-MENU	346
POT À INFUSIONS	324
POT MESUREUR	82
POTEAU	356-357
PRÉSENTOIR 3 NIVEAUX. CUBIC	250
PRÉSENTOIR BACS GASTRONORME	293-296
PRÉSENTOIR BOLS MÉLAMINE. CUBIC	242-247, 255
PRÉSENTOIR DE TARTES	373
PRÉSENTOIR GRANITE-ARDOISE	292
PRESSE FRUITS	209
PRESSE CITRON	318
PRESSE-AIL	111, 77
PROTECTRICE EN VINYLE	167
PUJADAS 1921. FONTE ULTRALÉGER INDUCTION	92-93
RACLETTE	64-66, 76, 370
RAMASSE-COUVERTS	353, 252
RAMASSE-COUVERTS POUR CHARIOT SERVICE	155
RAMASSE-MIETTES	341

ARTICLE	PAGE
RAMEQUIN.....	308
RÂPE.....	67-68, 110
RECEPTALBE À DÉCHETS.....	344
RÉCHAUD.....	230-232
RÉCIPIENT À GLACE.....	377
RECTANGLE POUR PLAQUES INOX.....	53
REFRAÎCHISSEUR.....	316
REFRAÎCHISSEUR BOUTEILLES. CUBIC.....	265
REFRAÎCHISSEUR ISOTHERME.....	315-316
RINCE-CUILLÈRES ACIER INOX.....	377
ROBOT MULTIFUNCTION.....	191-195
ROULEAU.....	369
ROULETTE À PÂTES.....	368, 384
ROULETTE À PIZZA.....	64
RUBAN PÂTISSIER.....	385
SALADIER.....	273
SALAMANDRE.....	220
SAUCIÈRE.....	342
SAUPOUDREUSES.....	74
SAUTEUSE ALUMINIUM.....	35
SAUTEUSE HANDY.....	31
SAUTEUSE HOBBY CHEF.....	105
SAUTEUSE INOX-PRO.....	28
SAUTEUSE MULTI-METAL.....	99
SCIE DE CUISINE.....	66, 76
SEAU À CHAMPAGNE.....	312-317
SEAU À CHAMPAGNE EN PLASTIQUE.....	316
SEAU À GLACE ISOTHERME.....	315
SEAU À GLAÇONS.....	315
SEAU AVEC BASE.....	82
SEAU GALVANISÉ.....	315
SÉPARATEUR DE PORTIONS.....	370
SETS DE TABLE.....	328-329
SHAKER.....	318
SHAKER ÉLECTRIQUE.....	208
SOUPIÈRE.....	272
SPATULE GÉANTE.....	76
STOP GOUTTES.....	319
SUCRIER.....	321-323
SUPPORT À PIQUES. CUBIC.....	244-245
SUPPORT DE TABLE POUR SEAUX.....	316
SUPPORT DOUBLE PORTE-COUVERTS GN.....	353
SUPPORT NUMÉRO.....	341
SUPPORT POUR BACS GN.....	151, 165, 352
SUPPORT POUR BACS GN.....	126, 296
SUPPORT POUR CORNETS.....	376
SUPPORT POUR COUVERCLES GN.....	126
SUPPORT POUR ENTONNOIR OU CHINOIS.....	70, 374
SUPPORT POUR GRANDS PLATEAUX.....	343
SUPPORT POUR PLANCHES À DÉCOUPER.....	126
SUPPORT POUR PLAQUES À PIZZA.....	56
SUPPORT POUR PLATEAU À FRUITS DE MER.....	342
SUPPORT POUR POCHE PÂTISSIER.....	390
SUPPORT RAMASSE-COUVERTS.....	151, 155, 165, 252, 289, 352
SUPPORT USTENSILES (5 CROCHETS).....	265-268
TABLE À DÉCOUPER.....	81

ARTICLE	PAGE
TABLE EN BOIS. CUBIC.....	253, 261
TABLEAUX.....	358-359
TAMIS.....	373
TAMIS À FARINE.....	71
TAPIS.....	326-327
TASSE.....	309-310, 354
THÉIÈRE.....	321-324
THERMOMÈTRE.....	84-85
TIRE-BOUCHONS.....	319
TOASTEUR.....	214-217
TOILE DE CUISSON.....	56
TOP LINE.....	18-21
TORCHE À CARAMÉLISER.....	372
TORCHON EN SILICONE.....	87
TRANCHEUR ÉLECTRIQUE.....	192
TURBINE À GLACE.....	188-191
USTENSILES MANCHE EN BOIS.....	64-65
VASQUE.....	316
VERRE.....	355
VERSATIL MACHINE.....	78
VERSEUSE À POMPE.....	339
VIDE / COUPE POMMES.....	110, 77-78
VITRINES PRÉSENTATION.....	263
WOK ACIER.....	47
WOK BLACK SERIES.....	95
WOK INOX.....	46
WOK MULTIMETAL.....	99
WOK PUJADAS 1921.....	93

DEUTSCH

ARTIKEL	SEITE
ABRÄUMWAGEN	155
ABSPERRUNG	356-357
ALUMINIUMGUSSPFANNE	95-97
ALUMINIUMSAUTEUSE	35
ALUMINIUMTOPF	35
ALU-PRO	32-35
ANTIHAFTBESCHICHTETES ALUMINIUMBLECH	53-54
ANTITROPFRING	319
ANZEIGETAFELN	292, 336-337
APARTAMENT	106
APFELAUSSTECHER	110, 77-78
ASCHENBECHER	344
AUSSTRICHMESSER	64, 66, 110
AUSLAGEVETRINE	263
AUSSTECHFORMEN	368, 384
AUSSTELLER GASTRONORM	293-296
BARFLASCHE	325
BEHÄLTER FÜR SERVICEWAGEN	155
BESTECKKASTEN	353, 252
BESTECKKASTEN	151, 155, 165, 252, 289, 352
BESTECKKÖRBCHEN	142
BESTECKSPÜLKORB	142
BLACK SERIES	94-97
BLINISPFANNE	44
BRÄTER	51, 96-97, 99
BRENNSTOFF FÜR CHAFING DISH	278
BROTKORB	284-285, 309
BROTKÖRBE	284
BUFFET CUBIC. BUFFETWAGEN	148-151
BUFFET CUBIC. KÜBEL UND REGALE	236-237, 239-255
BUFFET CUBIC. VITRINE	236-237, 256-260
BUFFETFLASCHENKÜHLER. CUBIC	265
BUFFETTISCHCHEN	253, 261
BUFFETZANGE	63, 270
CHAFING DISH	274-279
COCKTAIL-LÖFFEL	318
COCKTAIL-SIEB	318
COOL • LINE	100-101
COUSCOUSTOPF	26
CREPE-EISEN	227
CREPEPFANNE	44, 47, 97
DAMPFGARER COOL • LINE	101
DAMPFGARER HOBBY CHEF	105
DAMPFGARER INOX-PRO	26
DECKEL FRÜHSTÜCKSTASSE	354
DECKEL FÜR KOCHGESCHIRR	21, 27, 31, 35, 105
DECKEL INOX-PRO	27
DECKEL POLINORM®	121, 125, 129, 131, 132
DECKELGN	121, 125, 129, 131, 132, 133
DEKORATIONSPACHTEL	370
DESSERTHAUBE	372
DIGITALE KÜCHENUHR	84
DOPPELTER FAST-FOOD TABLETT-TROLLEY	163
DOSIERUNGSTRICHTER	374
DOSSIERKASSEROLLEN	82
DREIECKIGE FORM	388

ARTIKEL	SEITE
DREIECKSFORM	384
DREIFUSSTÄNDER FÜR GASBRENNER	49
DRUCKDISPENSER	74
EDELSTAHL MINIATUREN	330-331
EIERSCHNEIDER	77
EIFORM	75
EIMER MIT FUSS	82
EINSTELLBARER TELLERWAGEN	167
EINWEG	347-351
EINWEG-HÜLLEN AUS POLYÄTHYLEN	165
EISCREMEBECHER	376
EISCREMESCHALEN	377
EISCREMESPACHTEL	376
EISCREMEWAFFELSTÄNDER	376
EISCRUSHER	210
EISDIELE	188-191, 376-377
EISKÜBEL	315
EISMASCHINE	188-191
EISPORTIONIERER	376
EISWÜRFELSCHALE	316
ELEKTRISCHER AUFSCHNITTMASCHINE	192
ELEKTRISCHER BRENNER	372
ELEKTRISCHER GRILL	219
ELEKTRISCHER TOPF	279
ELEKTRISCHES ELEMENT FÜR CHAFING DISH	278
EMAILLIERTE GASPAELLAPFANNE	49
EMAILLIERTE PAELLAPFANNE AUS STAHL	48
ESSSTÄBCHEN	311
FAST-FOOD- SCHAUFEL	64-66
FAST-FOOD-TABLETT	352
FESTER DECKEL FÜR RECHTECKIGEN BEHÄLTER	354
FISCHENTSCHUPPER	76
FISCHPLATTE	272
FISCHWENDER	59, 109, 64-64
FLAP IDENTIFIKATION	146
FLAP-RACK®	136-147, 144-147
FLASCHENKÜHLER MIT FUSS 3 FLASCHEN FUSS	317
FLASCHENÖFFNER	110
FLEISCHSTAMPFER	75
FOLIENSCHNEIDER	319
FORMEN "FLEXIPLAN"	403-411
FRANZÖSISCHER KOCHTOPF INOX-PRO	20, 29
FRITEUSE	212-213
FRITTENHEBER	63
FRITTIERSCHAUFEL	61
GABEL	60, 107, 66, 76, 264-269
GALVANISIERTER EIMER	315
GASTRONORM BEHÄLTER OHNE BPA	109, 121, 130-131
GASTRONORM DIFFUSIONSBODEN	127
GASTRONORM MELAMIN	291-311
GASTRONORM POLYKARBONAT	128-129
GASTRONORM POLYPROPYLEN	132-133
GASTRONORM ROSTFREI	122-127
GASTRONORMTABLETT	52
GEBÄCKZANGE	270
GELOCHTE BÖDEN GASTRONORM	124-125, 129, 131, 161

ARTIKEL	SEITE
GEMÜSEHACKER	81
GEMÜSEHOBEL	73
GEMÜSESCHNEIDER	192
GEMÜSESIEB	72
GETRÄNKEMIXER	208
GEWÜRZKISTE	318
GEWÜRZMÜHLE	210
GEWÜRZSTÄNDER	74
GLAS	355
GN TRANSPORTWAGEN	157, 158, 161
GRANIT-SCHIEFER PRÄSENTIERPLATTE	292
GRILL	217-219
GRILL	95-97
GRILLPLATTE MIT GRIFFEN ALUMINIUM	97
HAKEN	72, 356
HALBKUGELFORM	388
HALTER FÜR BESTECKKASTEN GN	353
HALTER FÜR GN DECKEL	126
HALTER FÜR GROSSE PLATTEN	343
HALTER FÜR SCHNEIDEBRETTER	126
HALTER FÜR SPRITZBEUTEL	390
HANDY	30-31
HANDY KASSEROLLE	30
HANDY PAELLAPFANNE	31
HANDY STIELKASSEROLLE	31
HANDY STIELKASSEROLLE	31
HANDY TOPF	30
HERDPLATTE	232
HERZFORM	386
HOBBY CHEF	104-105
IDEA KASSEROLLE	103
IDEA KOCHBEDARF	102-103
IDEA STIELKASSEROLLE	103
IDEA TOPF	103
INDIVIDUELLE PLATZMATTEN	328-329
INDUKTIONSPLATTE	222
INDUSTRIELLER BRENNER	49
INDUSTRIELLER DOSENÖFFNER	78
INFORMATIONSTAFEL	357
INOX-PRO	22-29
ISOTHERMISCHER EISKÜBEL	315
ISOTHERMISCHER KÜHLER	315-316
ISOTHERMISCHES TABLETT	354
KAFFEEKANNE	321-323
KANNE	339-340
KARTENHALTER	346
KÄSEHOBEL	110
KASSEROLLE	96
KASSEROLLE ALUMINIUM	33-34, 332
KASSEROLLE APARTAMENTO	106
KASSEROLLE BLACK SERIES	96
KASSEROLLE COOL • LINE	101
KASSEROLLE COOL • LINE	101
KASSEROLLE HOBBY CHEF	105
KASSEROLLE HOBBY CHEF	104
KASSEROLLE INOX-PRO	24-25, 27

ARTIKEL	SEITE
KASSEROLLE PUJADAS 1921	93
KASSEROLLE TOP LINE	18-19
KNOBLAUCHPRESSE	111, 77
KOCHTOPF INOX-PRO	29
KOLLEKTIVITÄT	352-359
KOMPLETTE REGALSETS	174-185
KONISCHE, TIEFE PLATTE	356
KONISCHER KOCHTOPF	21, 29, 31, 35, 99, 364
KORKENZIEHER	319
KREIDEMARKER	359
KRÜMMELCHAUFEL	341
KUCHENBACKFORM	398, 378, 388
KÜCHENBEDARF 8-TLG HOBBY CHEF	105
KÜCHENBRENNER	372
KÜCHENMASCHINE	191-195
KÜCHENMASCHINE	78
KÜCHENSÄGE	66, 76
KÜCHENSET 5-TEILIG	264
KUGELSCHNEIDER	111
KÜHLERHALTER MIT FUSS	317
KÜHLPLATTE	273
LÖFFEL	60, 107-108, 409, 264-269, 309, 318
LYONER PFANNE	47
MATTEN	326-327
MEERESFRÜCHTEZANGE	271
MEHLSIEB	71
MELAMIN MINIATUREN	332
MELAMIN PRÄSENTATION	290-311, 332
MELAMIN PRÄSENTIERSCHALEN	242-247, 255
MENÜHALTER	346
MESSBECHER	318
MESSBECHER	82
MESSER	265-267, 265-267
MESSER/RAD (ERSATZTEIL)	78
MESSERSCHÄRFER	209
MIKROWELLE	224
MILCHDISPENSER	279
MILCHKÄNNCHEN	321-323
MINIATUREN GUSSEISEN	334-335
MINIS AUS ALUMINIUM GUSS	332
MIXER	200-207
MULTIMETAL	98-99
NAMENSSCHILDER MIT CLIP	146
NATURBAMBUS & HOLZ	280-281
NOTIZLEISTE	75
NUDELKOCHER	220
NUDELSIEB	27
NUSSKNACKER	271
ÖFEN	223
OFENZANGE	56
ÖLKANNE	75
ORIENTALISCHE SCHÜSSEL	311
OVALE FORM	386
OVALE PLATTE	343
OVALE PLATTE	272, 304-305
PAELLAPFANNE ALUMINIUM	43

DEUTSCH

ARTIKEL	SEITE
PAELLAPFANNE HOBBY CHEF	104
PAELLAPFANNE INOX-PRO	24-25
PAELLAPFANNE PUJADAS 1921	93
PAELLAPFANNE TOP LINE	18-19
PATISSERIEFORMEN	378-382, 385-388, 395-402, 403-411
PATISSERIE-PISTOLE	389
PATISSERIEROST	54, 375
PATISSERIETABLETT	375, 52-54
PFANNE ALUMINIUM	42-44, 106
PFANNE BLACK SERIES	95, 97
PFANNE EDELSTAHL	46
PFANNE IDEA	103
PFANNE MULTIMETAL	99
PFANNE PUCHADAS 1921	93
PFANNEN	38-49, 93, 95, 99, 106
PFANNENWENDER	59, 107-108, 64, 264-269, 367
PFEFFERMÜHLE	342
PINSEL	76
PINSEL	109, 369
PIZZAFORM	55
PIZZAMESSER	64
PIZZAPLATTE	55
PIZZAROST	56
PIZZASCHAUFEL	56
PLASTIK-SEKTKÜHLER	316
PLATTE (MEERESFRÜCHTE)	342
POLYPROPYLEN KÖRBE	282-289
POMMES FRITES-SCHNEIDER	77-78
PORTIONIERER	365
PRÄSENTATIONSTABLETT. CUBIC	243-245, 248-249, 251-252
PRÄSENTATIONSPLATTE	303
PRÄSENTIERHALTER FÜR SPIESSCHEN, VIERECKIG	244-245
PRÄZISIONSPINZETTE	62
PRESSE	209
PUDDINGFORM	380, 387, 398
PUJADAS 1921. GUSSEISEN ULTRALEICHT INDUKTION	92-93
PVC-BAND FÜR MOUSSE	385
QUADRATISCHE FORM	387
RAHMEN FÜR BACKBLECHE	53
RECHTECKIGE MARMOR-PRÄSENTATIONSPLATTE	292
REGALE	168-185
REIBE	67-68, 110
REISKOCHER	220
RING	385
ROST GN	54
RÜHRBESEN	366
RÜHRQUIRL	76
RÜHRSCHÜSSEL	364-365
SAFTDISPENSER	279
SAFTPRESSE	208
SAFTSPENDER. CUBIC	250
SALAMANDER	220
SALATSCHÜSSEL	273
SALZMÜHLE	342
SAUTEUSE HOBBY CHEF	105
SAUTEUSE INOX-PRO	28

ARTIKEL	SEITE
SAUTEUSE MULTIMETAL	99
SCHABER	64-66, 76, 370
SCHALE	297-298, 298-300, 305-311, 310-311, 354
SCHAUMLÖFFEL	59, 61, 107-108, 264-269
SCHILD "RAUCHEN VERBOTEN"	341
SCHILD "RESERVIERT"	341
SCHNEIDEBRETT	80-81
SCHNEIDETISCH	81
SCHOKOLADENBRUNNEN	226
SCHOKOLADENFORMEN	399
SCHÖPFLÖFFEL	58, 107-108, 264-269, 309
SCHUTZHANDSCHUHE	86-87
SCHUTZHÜLLE VINYL	167
SECHSECKIGE FORM	386
SEKTKORKEN	319
SEKTKÜHLER	312-317
SELBSTBEDIENUNGSTABLETT EDELSTAHL	353
SEPARIERER FÜR TOPF MIT HAHN	27
SERVIERPLATTE	291-292
SERVIERTABLETT	325
SERVIERWAGEN (ALUMINIUM)	152
SERVIERWAGEN (DEMONTIERBAR)	154
SERVIERWAGEN (INOX)	153-155
SERVIETTENHALTER	345
SERVIETTENSPENDER	253
SETS. CUBIC	246-249
SHAKER	318
SIEB	373
SIEB	71-73
SIEB	71
SILIKON-CO-COTTE	112
SILIKONFORMEN	395-402
SILIKONFORMEN 600 X 400	400-402
SILIKONPAPIER	56
SILIKONTUCH	87
SILIKONTUCH	56
SNACKSCHÄLCHEN	342
SOSSEN- UND SNACKHALTER	342
SOSSENSCHALE	308
SPARSCHÄLER	111
SPIESS	343
SPIESSCHENHALTER, VIERECKIG	244-245
SPIESSHALTER	343
SPITZSIEB	70
SPRITZBEUTEL	390
SPÜLBECKEN FÜR PORTIONIERER	377
SPÜLKORB (GESCHLOSSENES SYSTEM)	140-141
SPÜLKORB (GROSSE TABLETTS)	145
SPÜLKORB (ISOTHERMISCHE TABLETTS)	145
SPÜLKORB (OFFENES SYSTEM)	138-139, 142
SPÜLKORB (TELLER)	143-145
SPÜLKORBDECKEL	142
STABMIXER	196-198
STAHLWOK	47
STÄNDER DREI EBENEN. CUBIC	250
STÄNDER FÜR GN BEHÄLTER	126, 296

ARTIKEL	SEITE
STÄNDER FÜR MEERESFRÜCHTEPLATTE	342
STÄNDER FÜR SEKTKÜHLER	316
STÄNDER FÜR SPITZSIEB ODER TRICHTER	70, 374
STIELKASSEROLLE APARTAMENTO	106
SUPPENSCHÜSSEL	272
TABLETT ...52-55, 145, 163-164, 272, 299-300, 300-305, 325, 352-354	
TAFELN	358-359
TASSE	309-310, 354
TEE- UND ZUCKERBEUTELHALTER	253
TEEKANNE	324
TEEKANNE	321-324
TEESIEB	324
TEIGROLLE	369
TELLER	298-299, 303, 308-311, 354
TELLERWÄRMER	230-232
THERMOMETER	84-85
THERMOSKANNE	339
THERMOSKANNE MIT DOSIERER	339
TIEFE, EMALLIERTE PFANNE MIT GRIFFEN	48
TISCHABFALLEIMER	344
TISCHNUMMERHALTER	341
TISCHNUMMERN	341
TOASTER	214-217
TOMATENSCHNEIDER	73
TOP LINE	18-21
TOPF ALUMINIUM	33-34
TOPF APARTAMENTO	106
TOPF COOL • LINE	100
TOPF HOBBY CHEF	104
TOPF INOX-PRO	24-25, 27
TOPF MIT HAHN	27
TOPF TOP LINE	18-19
TOPFHANDSCHUH	86-87
TORTENHEBER	107-108, 64, 66, 110
TORTENSCHNEIDER	370
TORTENSTÄNDER	373
TRÄNENFORM	386
TRANSPORTWAGE FÜR BESTECKBEHÄLTER	151, 165, 352
TRICHTER	74, 374
TROLLEY (GUERIDON)	150-151
TROPFENFORM	386
TÜLLE	391-394
TÜLLE POLYCARBONAT	394
UNIVERSALSCHÄLER	111
UNIVERSALSPÜLKORB	142
UNIVERSELLER KORKEN	319
UTENSILIEN MIT HOLZGRIFF	64-65
VALENZIANISCHE PAELLAPFANNE	48
VERSTELLBARE PROFILE	120, 123
VOGELNESTFORM	61
WAAGE	83-84
WAFFELEISEN	227
WAGEN (AUFTAUEN)	161
WAGEN (EINSCHÜBE DEMONTIERBAR)	158-163
WAGEN (EINSCHÜBE)	157-166
WAGEN (HOLZ)	148-151

ARTIKEL	SEITE
WAGEN (KLAPPBAR)	157
WAGEN (KUNSTSTOFF)	152, 166-167
WAGEN (STAPELBAR)	159-160
WAGEN AUFTAUEN	161
WAGEN FÜR SCHWERE LASTEN	165
WAGEN FÜR SPÜLKORBE	166
WAGEN MIT ARBEITSFLÄCHE	165
WAGEN MIT EINSCHÜBEN FÜR DEN OFEN	162
WANDHALTER (ZUBEHÖR) 5 HAKEN	265-268
WÄRMELAMPE	231-232
WARMHALTESCHRANK	228-230
WASSERBAD	225-226, 274-275
WASSERBAD GASTRONORM	225
WECHSELGELSTELLERCHEN	346
WEINKARTE	346
WEINKLIMASCHRANK	233
WEINKÜHLER	316
WOK BLACK SERIES	95
WOK INOX	46
WOK MULTIMETAL	99
WOK PUJADAS 1921	93
WURSTZANGE	270-271
ZANGE	62-63, 107-109, 270-271, 318
ZANGE MIT RINGEN	270
ZETTELSPIESSER	343
ZITRONENPRESSE	318
ZUCKERDOSE	321-323
ZWIEBELSCHNEIDER UND FLEISCHSTECHER	111

PORTUGUÊS

ARTIGO	PÁGINA
ABRE-LATAS INDUSTRIAL.....	78
ABRIDOR GARRAFAS	110
AÇUCAREIRO.....	321-323
AFIADOR DE FACAS	209
ALMOTOLIA.....	75
ALU-PRO.....	32-35
ANEL ANTI-GOTEJAMENTO	319
APANHADOR DE MIGALHAS.....	341
APARTAMENTO	106
APRESENTADOR CUBAS GN	126, 296
APRESENTADOR TIGELAS MELAMINA. CUBIC.....	242-247, 255
AQUECEDOR DE PRATOS	230-232
ARANHA.....	61
ARDÓSIAS.....	358-359
ARDÓSIAS APRESENTAÇÃO	292, 336-337
ARGOLA DE GUARDANAPO	345
ARGOLA DE GUARDANAPO. CUBIC	253
ARMÁRIO QUENTE.....	228-230
ARMÁRIO REFRIGERADOR GARRAFAS	233
ARO	385
ASSADEIRA.....	51, 96-97, 99
ASSADOR GRILL.....	95-97
BALANÇA.....	83-84
BALDE CHAMPANHE	312-317
BALDE COM BASE.....	82
BALDE DE GELO DE PLÁSTICO	316
BALDE DE GELO ISOTÉRMICO	315
BALDE DE GELO SALADEIRA	316
BALDE GALVANIZADO.....	315
BALDE GELO.....	315
BAMBU NATURAL & MADEIRA	280-281
BANDEJA	52-55, 145, 163-164, 272, 299-300, 300-305, 325, 352-354
BANDEJA ALUMÍNIO ANTI-ADERENTE	53-54
BANDEJA EMPREGADO DE BAR.....	325
BANDEJA EXPOSIÇÃO	303
BANDEJA FAST-FOOD	352
BANDEJA GASTRONORM	52
BANDEJA ISOTÉRMICA.....	354
BANDEJA OVAL	343
BANDEJA PARA MARISCOS.....	342
BANDEJA PASTELARIA.....	375, 52-54
BANDEJA PORTA-TALHERES.....	353, 252
BANDEJA SELF-SERVICE AÇO INOX.....	353
BANDEJAS. CUBIC.....	243-245, 248-249, 251-252
BANDOLINS.....	73
BANHO-MARIA.....	225-226, 274-275
BANHO-MARIA GASTRONORM	225
BARRA DE NOTAS	75
BASE PIZA	55
BATEDEIRAS DE COPO	200-207
BATEDEIRAS PARA BATIDOS.....	208
BATEDOR	366
BATERIA COZINHA 8 PEÇAS HOBBY CHEF	105
BATERIA IDEA.....	102-103
BLACK SERIES	94-97
BOLSA PROTECTORA DE VINIL	167

ARTIGO	PÁGINA
BOLSAS REJEITÁVEIS POLIETILENO DISTRIBUIDOR	165
BOQUILHA	391-394
BOQUILHA POLICARBONATO.....	394
BRAÇOS TRITURADORES.....	196-198
BUFETE CUBIC. BALDES E ESTANTES.....	236-237, 239-255
BUFETE CUBIC. CARRO BUFETE.....	148-151
BUFETE CUBIC. MÓVEL EXPOSITOR	236-237, 256-260
ÇAÇAROLA ALUMÍNIO.....	33-34, 332
ÇAÇAROLA APARTAMENTO.....	106
ÇAÇAROLA COOL • LINE	101
ÇAÇAROLA HANDY.....	30
ÇAÇAROLA HOBBY CHEF	104
ÇAÇAROLA IDEA.....	103
ÇAÇAROLA INOX-PRO.....	24-25, 27
ÇAÇAROLA TOP LINE.....	18-19
ÇAÇOILA ALUMÍNIO FUNDIÇÃO	96
ÇAÇOILA BLACK SERIES	96
ÇAÇOILA PUXADAS 1921	93
CAFETEIRA	321-323
CAIXA CONDIMENTOS	318
CALDEIRO	364-365
CAMPÂNULA PARA SOBREMESAS	372
CARRO BASCULANTE.....	157
CARRO COM GUIAS.....	157-166
CARRO COM GUIAS PARA FORNO.....	162
CARRO COM GUIAS, DESMONTÁVEL	158-163
CARRO COM GUIAS, ENCASTRÁVEL.....	159-160
CARRO COM SUPERFÍCIE DE TRABALHO	165
CARRO DE MADEIRA.....	148-151
CARRO DE PLÁSTICO.....	152, 166-167
CARRO DE SERVIÇO DESMONTÁVEL	154
CARRO DE SERVIÇO EM ALUMÍNIO	152
CARRO DE SERVIÇO INOXIDÁVEL	153-155
CARRO DESCONGELAÇÃO.....	161
CARRO DESEMBARAÇO.....	155
CARRO DUPLO PARA BANDEJAS FAST-FOOD	163
CARRO GASTRONORM DESCONGELAÇÃO	161
CARRO GUERIDON.....	150-151
CARRO PARA CARGAS PESADAS	165
CARRO PARA CESTOS.....	166
CARRO PARA PRATOS AJUSTÁVEL	167
CARRO PORTA-CUBAS GASTRONORM.....	157, 158, 161
CARRO PORTA-TALHERES	151, 165, 352
CESTINHO PARA TALHERES	142
CESTO DE PAPÉIS MESA	344
CESTO GRANDES BANDEJAS	145
CESTO PARA BANDEJAS ISOTÉRMICAS.....	145
CESTO PARA TALHERES.....	142
CESTO UNIVERSAL	142
CESTOS ABERTOS.....	138-139, 142
CESTOS FECHADOS.....	140-141
CESTOS PARA PRATOS	143-145
CESTOS POLIPROPILENO.....	282-289
CHAFING DISH	274-279
CHALEIRA.....	321-324
CHÁVENA.....	309-310, 354

ARTIGO	PÁGINA
CINZEIRO	344
COADOR	71-73
COADOR CHINÊS	70
COADOR DE LÍQUIDOS	318
COADOR DE MASSA	27
COADOR ESFERA INFUSÕES	324
CO-COTTE SILICONE	112
COLECTIVIDADES	352-359
COLHER	60, 107-108, 409, 264-269, 309, 318
COLHER BATEDEIRA	318
COLHER PARA UNTAR	64, 66, 110
CONCHA	58, 107-108, 264-269, 309
CONJUNTO COZINHA 5 PEÇAS	264
CONJUNTO DE TEMPEROS	74
CONJUNTOS DE ESTANTES COMPLETOS	174-185
CONJUNTOS. CUBIC	246-249
CONSUMÍVEIS	347-351
COOL • LINE	100-101
COPO	355
COQUETELEIRA	318
CORTA-CÁPSULAS	319
CORTADOR BOLAS	111
CORTADOR DE BATATAS FRITAS	77-78
CORTADOR DE OVOS	77
CORTADOR DE VERDURAS	192
CORTADOR TOMATES	73
CORTADOR/DESCAROÇADOR MAÇÃS	110, 77-78
CORTADORA DE FIAMBRES ELÉCTRICA	192
CORTA-MASSAS	368, 384
COZE-MASSAS	220
CRIVO	373
CUBA GASTRONORM SEM BPA	109, 121, 130-131
CUBAS GELATARIA	377
CUSCUZEIRA	26
DESCASCADOR BATATAS	111
DESCASCADOR UNIVERSAL	111
DISTRIBUIDOR DE SUMOS	279
DISTRIBUIDOR LEITE	279
DISTRIBUIDOR PÃO	284
DISTRIBUIDOR SACOS CHÁ E AÇÚCAR. CUBIC	253
DISTRIBUIDOR SOB PRESSÃO	74
DISTRIBUIDOR SUMOS. CUBIC	250
DOSEADOR LICOR	318
ELEMENTO ELÉCTRICO CHAFING DISH	278
ESCAMADOR	76
ESCORREDOR	71
ESCOVA	76
ESCUMADEIRA	59, 61, 107-108, 264-269
ESMAGA-CARNES	75
ESPÁTULA	59, 107-108, 64, 264-269, 367
ESPETO PARA NOTAS	343
ESPETOS. SUPORTE APRESENTAÇÃO. CUBIC	244-245
ESPREMEDOR	209
ESPREMEDOR DE ALHOS	111, 77
ESPREME-LIMÕES	318
ESTANTES	168-185

ARTIGO	PÁGINA
EXPOSITOR DE TORTAS	373
EXPOSITOR GASTRONORM	293-296
EXPOSITOR TRÊS NÍVEIS. CUBIC	250
FACA	265-267, 265-267
FERVEDOR DE ARROZ	220
FITA PVC PARA MOUSSE	385
FLAP IDENTIFICAÇÃO	146
FLAP-RACK®	136-147, 144-147
FORMA DE PUDIM	380, 387, 398
FORNOS	223
FRITADEIRA	212-213
FUELÓLEO PARA CHAFING DISH	278
FUNDOS PERFURADOS GASTRONORM	124-125, 129, 131, 161
FUNIL	74, 374
FUNIL DOSEADOR	374
GANCHO	72, 356
GARFO	60, 107, 66, 76, 264-269
GARRAFA BAR	325
GASTRONORM FUNDO DIFUSOR	127
GASTRONORM INOXIDÁVEL	122-127
GASTRONORM MELAMINA	291-311
GASTRONORM POLICARBONATO	128-129
GASTRONORM POLIPROPILENO	132-133
GELATARIA	188-191, 376-377
GRAMPO DE IDENTIFICAÇÃO	146
GRELHA PLANA COM PEGAS ALUMÍNIO	97
GRELHADOR	217-219
GRELHAS GN	54
GRELHAS PASTELARIA	54, 375
HANDY	30-31
HOBBY CHEF	104-105
INOX-PRO	22-29
JARRA	339-340
JARRA DE MEDIÇÃO	82
JARRA PARA INFUSÕES	324
JARRA TERMO	339
LÂMINA/ROLO SOBRESSALENTE	78
LÂMPADA MANTENEDORA	231-232
LAVA-RACIONADOR AÇO INOX	377
LEITEIRA	321-323
LIQUIDIFICADORES	208
LISTA DE VINHOS	346
LUVA SEM DEDOS	86-87
LUVAS PROTECÇÃO	86-87
MAÇARICO COZINHA	372
MANGAS DE PASTÉIS	390
MANTA REFRIGERADORA	316
MÁQUINA DE CREPES	227
MÁQUINA DE GELADOS	188-191
MÁQUINAS DE GOFRES	227
MARCADOR DE TORTAS	370
MARCADORES GIZ	359
MELAMINA APRESENTAÇÃO	290-311, 332
MESA DE CORTE	81
MESINHA BUFFET. CUBIC	253, 261
MICRO-ONDAS	224

PORTUGUÊS

ARTIGO	PÁGINA
MINIATURAS ALUMÍNIO FUNDIÇÃO	332
MINIATURAS FERRO FUNDIDO	334-335
MINIATURAS INOX.....	330-331
MINIATURAS MELAMINA.....	332
MOINHO DE FARINHA.....	71
MOINHO ESPECIARIAS	210
MOINHO PIMENTA	342
MOINHO SAL	342
MOLDE CAKE.....	398, 378, 388
MOLDE CORTA-RODELAS.....	111
MOLDE FORMA CORAÇÃO.....	386
MOLDE FORMA GOTA.....	386
MOLDE FORMA LÁGRIMA.....	386
MOLDE HEXAGONAL.....	386
MOLDE MEIA CANA.....	388
MOLDE NINHO	61
MOLDE OVAL	386
MOLDE OVO	75
MOLDE PARA PIZA	55
MOLDE SEMIESFÉRICO.....	388
MOLDES "FLEXIPAN".....	403-411
MOLDES DE SILICONE.....	395-402
MOLDES PARA CHOCOLATE.....	399
MOLDES PASTELARIA	378-382, 385-388, 395-402, 403-411
MOLDES SILICONE 600 X 400.....	400-402
MOLHEIRA	342
MULTIMETAL	98-99
NÚMERO MESA	341
PÁ.....	365
PÁ APRESENTAÇÃO	291-292
PÁ BATATAS FRITAS	63
PÁ FAST-FOOD	64-66
PÁ GELADOS.....	376
PÁ PARA QUEIJO	110
PÁ PASTÉIS.....	107-108, 64, 66, 110
PÁ PEIXE	59, 109, 64-64
PÁ PIZA	56
PAINEL INFORMAÇÃO	357
PALITOS	311
PANELA A VAPOR COOL • LINE	101
PANELA A VAPOR HOBBY CHEF	105
PANELA A VAPOR INOX-PRO.....	26
PANELA ALUMÍNIO	33-34
PANELA APARTAMENTO.....	106
PANELA COM TORNEIRA.....	27
PANELA COOL • LINE.....	100
PANELA DE PAELHA ESMALTADA GÁS	49
PANELA ELÉCTRICA	279
PANELA HANDY	30
PANELA HOBBY CHEF	104
PANELA IDEA	103
PANELA INOX-PRO	24-25, 27
PANELA TOP LINE.....	18-19
PANO SILICONE	87
PAPEL SILICONIZADO.....	56
PASSADOR DE PURÉS	72

ARTIGO	PÁGINA
PÉ BALDE DE GELO 3 GARRAFAS	317
PÉ COM PORTA-BALDES	317
PENTE DECORADOR.....	370
PERFIS DIVISÓRIOS	120, 123
PICO/ESPETO	343
PINÇA.....	62-63, 107-109, 270-271, 318
PINÇA ANILHAS	270
PINÇA BUFETE.....	63, 270
PINÇA CHARCUTARIA.....	270-271
PINÇA FONTE FORNO.....	56
PINÇA PARA MARISCO	271
PINÇA PASTELARIA	270
PINÇAS PARA EMPRATAR	62
PINCEL	109, 369
PISTOLA PASTELARIA.....	389
PLACA "RESERVADO"	341
PLACA DE CORTE.....	80-81
PLACA ELÉCTRICA.....	219
PLACA INDUÇÃO.....	222
PLACA PROIBIDO FUMAR.....	341
PLACA QUENTE.....	232
PLACA REFRIGERADORA	273
PORTA-CARTÕES	346
PORTA-ESPETOS.....	343
PORTA-MENUS.....	346
PORTA-PÃO	284-285, 309
PORTA-SALGADOS/PORTA-MOLHOS	342
PORTA-TALHERES	151, 155, 165, 252, 289, 352
POSTE SEPARAÇÃO	356-357
PRATINHO TROCA	346
PRATOS.....	298-299, 303, 308-311, 354
PROCESSADOR DE ALIMENTOS	191-195
PUXADAS 1921. FERRO DE FUNDIÇÃO ULTRALEVE INDUÇÃO... ..	92-93
QUADRADO BOLEADO	387
QUADROS PARA BANDEJAS.....	53
QUEBRA-NOZES	271
QUEIMADOR ELÉCTRICO	372
QUEIMADOR INDUSTRIAL	49
RACIONADOR DE GELADO	376
RALADOR.....	67-68, 110
RASPADOR.....	64-66, 76, 370
RECIPIENTE PARA MOLHOS	308
RECOLHE-VERDURAS	81
REFRIGERADOR GARRAFAS BUFFET. CUBIC	265
REFRIGERADOR ISOTÉRMICO.....	315-316
RELÓGIO DE COZINHA DIGITAL.....	84
REMO	76
ROLETA CORTA-PIZAS	64
ROLO	369
SACA-ROLHAS	319
SALADEIRA ACRÍLICA.....	273
SALAMANDRA	220
SAUTEX ALUMÍNIO.....	35
SAUTEX HANDY	31
SAUTEX HOBBY CHEF.....	105
SAUTEX INOX-PRO.....	28

ARTIGO	PÁGINA
SAUTEX MULTIMETAL.....	99
SEPARADOR PARA PAINEL COM TORNEIRA	27
SERRA DE COZINHA	66, 76
SERTÃ "LIONESA"	47
SERTÃ AÇO ESMALTADO.....	48
SERTÃ AÇO INOXIDÁVEL.....	46
SERTÃ ALUMÍNIO	43
SERTÃ ALUMÍNIO	42-44, 106
SERTÃ ALUMÍNIO FUNDIÇÃO.....	95-97
SERTÃ BLACK SERIES	95, 97
SERTÃ CREPES	44, 47, 97
SERTÃ FUNDA ESMALTADA COM PEGAS.....	48
SERTÃ HANDY	31
SERTÃ HOBBY CHEF.....	104
SERTÃ IDEA	103
SERTÃ INOX-PRO	24-25
SERTÃ MULTIMETAL	99
SERTÃ PARA BLINIS	44
SERTÃ PUJADAS 1921.....	93
SERTÃ PUXADAS 1921	93
SERTÃ TOP LINE	18-19
SERTÃ VALENCIANA	48
SERTÃS	38-49, 93, 95, 99, 106
SUORTE APRESENTAÇÃO ARDÓSIA-MÁRMORE	292
SUORTE CARTUCHO.....	376
SUORTE MÁRMORE APRESENTAÇÃO	292
SUORTE MESA BANDEJA MARISCO	342
SUORTE PARA BALDE CHAMPANHE.....	316
SUORTE PARA BANDEJAS DE TAMANHO GRANDE	343
SUORTE PARA BANDEJAS PORTA-TALHERES GN.....	353
SUORTE PARA ESPETOS. CUBIC	244-245
SUORTE PARA MANGAS DE PASTÉIS.....	390
SUORTE PARA NÚMEROS	341
SUORTE PARA PASSADOR CHINÊS OU FUNIL	70, 374
SUORTE PARA PIZAS.....	56
SUORTE PARA PLACAS DE CORTE.....	126
SUORTE PAREDE (UTENSÍLIOS) 5 GANCHOS.....	265-268
SUORTE TAMPAS GN	126
TABULEIRO DE TALHERES PARA CARRO SERVIÇO.....	155
TAÇA GELADO.....	376
TACHO ALUMÍNIO.....	35
TACHO APARTAMENTO	106
TACHO BOLEADO	21, 29, 31, 35, 99, 364
TACHO COOL • LINE	101
TACHO HANDY.....	31
TACHO HOBBY CHEF	105
TACHO IDEA.....	103
TACHO INOX-PRO.....	29
TACHO TIPO FRANCÊS	20, 29
TACHOS DE MEDIÇÃO.....	82
TAMPA BATERIA	21, 27, 31, 35, 105
TAMPA CHAMPANHE	319
TAMPA CHÁVENA PEQUENO-ALMOÇO.....	354
TAMPA GN	121, 125, 129, 131, 132, 133
TAMPA INOX-PRO.....	27
TAMPA PARA CESTO	142

ARTIGO	PÁGINA
TAMPA POLINORM®.....	121, 125, 129, 131, 132
TAMPA RÍGIDA PARA TRAVESSA RECTANGULAR	354
TAMPA UNIVERSAL	319
TAPETE DE SILICONE	56
TAPETES	326-327
TERMO COM DOSEADOR.....	339
TERMÓMETRO.....	84-85
TERRINA	272
TIGELA	297-298, 298-300, 305-311, 310-311, 354
TIGELA ORIENTAL.....	311
TOALHAS DE MESA INDIVIDUAIS.....	328-329
TOP LINE.....	18-21
TORRADEIRA	214-217
TRAVESSA DE PEIXE BORDA VIRADA	272
TRAVESSA FONDUE CHOCOLATE	226
TRAVESSA FUNDA CÓNICA	356
TRAVESSA OVAL	272, 304-305
TRIÂNGULO BOLEADO.....	384
TRIPÉ PAINEL DE PAELHA.....	49
TRITURADOR DE GELO	210
UTENSÍLIOS CABO MADEIRA	64-65
VERSÁTIL MACHINE.....	78
VITRINAS APRESENTAÇÃO.....	263
WOK AÇO	47
WOK BLACK SERIES	95
WOK INOX	46
WOK MULTIMETAL	99
WOK PUXADAS 1921	93

Артикул	Страница
COOL • LINE	100-101
GASTRONORM МЕЛАМИНОВАЯ ПОСУДА	291-311
АЛЮМИНИЕВАЯ ЛИТАЯ МИНИ-КАСТРЮЛЯ	332
АЛЮМИНЕВЫЙ ПОДНОС С ПРОТИВОПРИГАРНЫМ ПОКРЫТИЕМ	53-54
БАРНОЕ СИТО СТРАЙНЕР	318
БАРЬЕРНЫЕ СТОЛБИКИ	356-357
БЛЕНДЕРЫ	208
БЛЕНДЕРЫ ДЛЯ КОКТЕЙЛЕЙ	208
БЛЕНДЕРЫ КУВШИННЫЕ	200-207
БЛЕНДЕРЫ ПОГРУЖНЫЕ	196-198
БЛИННИЦА	227
БЛЮДО ДЛЯ РЫБЫ С ЗАКРУГЛЕННЫМИ КРАЯМИ	272
БРУС ДЛЯ ЗАМЕТОК	75
БУТЫЛКА ДЛЯ БАРА	325
БУФЕТ "CUBIC" ТЕЛЕЖКА БУФЕТНАЯ	148-151
БУФЕТ CUBIC ВИТРИНА	236-237, 256-260
БУФЕТ CUBIC КУБЫ И ПОЛКИ	236-237, 239-255
ВЕДРО ДЛЯ ЛЬДА	315
ВЕДРО ДЛЯ ЛЬДА ИЗОТЕРМИЧЕСКОЕ	315
ВЕДРО ДЛЯ МУСОРА НАСТОЛЬНОЕ	344
ВЕДРО ДЛЯ ШАМПАНСКОГО	312-317
ВЕДРО С ОСНОВОЙ	82
ВЕНЧИК	366
ВЕСЛО	76
ВЕСЫ	83-84
ВИЛКА	60, 107, 66, 76, 264-269
ВИННАЯ КАРТА	346
ВИТРИНА GASTRONORM	293-296
ВИТРИНА ТРЕХ-УРОВНЕВАЯ CUBIC	250
ВОРОНКА	74, 374
ВОРОНКА С ДОЗАТОРОМ	374
ВОСТОЧНАЯ ПИАЛА	311
ГАЗОВАЯ ГОРЕЛКА	372
ГАЛЬВАНИЗИРОВАННОЕ ВЕДРО	315
ГASTРОЕМКОСТЬ GASTRONORM, БЕЗ ДФП	109, 121, 130-131
ГASTРОЕМКОСТЬ ИЗ НЕРЖ. СТАЛИ	377
ГОРЕЛКА ПРОМЫШЛЕННАЯ	49
ГОРЮЧЕЕ ДЛЯ ЧАФИНДИША	278
ГОРЯЧАЯ ПЛИТА	232
ГОФРЕНИЦА	227
ГРИЛЬ	217-219
ГРИЛЬ САЛАМАНДРА	220
ДЕЛИТЕЛЬ ДЛЯ ТОРТА	370
ДЕРЖАТЕЛИ ДЛЯ КОНДИТЕРСКИХ МЕШКОВ	390
ДЕРЖАТЕЛЬ ДЛЯ ВИЗИТОК	346
ДЕРЖАТЕЛЬ ДЛЯ КИТАЙСКОГО ДУРШЛАГА ИЛИ ВОРОНКИ	70, 374
ДЕРЖАТЕЛЬ ДЛЯ КОНУСНОГО СТАКАНЧИКА	376
ДЕРЖАТЕЛЬ ДЛЯ МЕНЮ	346
ДЕРЖАТЕЛЬ ДЛЯ ПАЛОЧЕК	343
ДЕРЖАТЕЛЬ ДЛЯ ПОДНОСОВ С ПРИБОРАМИ GN	353
ДЕРЖАТЕЛЬ ДЛЯ РАЗДЕЛОЧНЫХ ДОСОК	126
ДЕРЖАТЕЛЬ НОМЕРКОВ	341
ДЖИГЕР	318
ДИСПЕНСЕР ДЛЯ МЕШОЧКОВ ЧАЯ И САХАРА CUBIC	253
ДИСПЕНСЕР ДЛЯ МОЛОКА	279
ДИСПЕНСЕР ДЛЯ СОКОВ	279

Артикул	Страница
ДИСПЕНСЕР ДЛЯ ХЛЕБА	284
ДИСПЕНСЕР ПОД ДАВЛЕНИЕМ	74
ДИСПЕНСЕР С ОДНОРАЗОВЫМИ ПОЛИЭТИЛЕНОВЫМИ ЧЕХЛАМИ	165
ДОСКА РАЗДЕЛОЧНАЯ	80-81
ДОСКИ	358-359
ДУРШЛАГ	71-73
ДУРШЛАГ	71
ДУРШЛАГ ДЛЯ МАКАРОННЫХ ИЗДЕЛИЙ	27
ДУХОВЫЕ ШКАФЫ	223
ЕМКОСТЬ ДЛЯ ПРЕЗЕНТАЦИИ МЕЛАМИНОВЫХ ПИАЛ CUBIC	242-247, 255
ЖАРОВНЯ-ГРИЛЬ	95-97
ЗАЩИТНЫЕ ПЕРЧАТКИ	86-87
ЗАЩИТНЫЙ ВИНИЛОВЫЙ ЧЕХОЛ	167
ИДЕНТИФИКАЦИОННЫЙ ЗНАЧЕК	146
ИДЕНТИФИКАЦИОННЫЙ КЛИП	146
ИЗМЕЛЬЧИТЕЛЬ ДЛЯ СПЕЦИЙ	210
ИЗМЕЛЬЧИТЕЛЬ ЛЬДА	210
ИЗОТЕРМИЧЕСКИЙ ОХЛАДИТЕЛЬ	315-316
ИНВЕНТАРЬ С ДЕРЕВЯННЫМИ РУЧКАМИ	64-65
ИНДИВИДУАЛЬНЫЕ КОВРИКИ ДЛЯ СЕРВИРОВКИ	328-329
ИНДУКЦИОННАЯ ПЛИТА	222
ИНФОРМАЦИОННОЕ ТАБЛО	357
КАСТРЮЛКА	58, 107-108, 264-269, 309
КАСТРЮЛЯ APARTAMENTO	106
КАСТРЮЛЯ COOL • LINE	101
КАСТРЮЛЯ HANDY	30
КАСТРЮЛЯ HOBBY CHEF	104
КАСТРЮЛЯ IDEA	103
КАСТРЮЛЯ INOX-PRO	24-25, 27
КАСТРЮЛЯ PUJADAS 1921	93
КАСТРЮЛЯ TOP LINE	18-19
КАСТРЮЛЯ АЛЮМИНИЕВАЯ	33-34, 332
КАСТРЮЛЯ ВОК PUJADAS 1921	93
КАСТРЮЛЯ ВОК MULTIMETAL	99
КАСТРЮЛЯ ВОК ИЗ НЕРЖАВЕЮЩЕЙ СТАЛИ	46
КАСТРЮЛЯ ВОК ИЗ СТАЛИ	47
КАСТРЮЛЯ ВОК СЕРИИ BLACK	95
КАСТРЮЛЯ ГЛУБОКАЯ	24-25, 27
КАСТРЮЛЯ ГЛУБОКАЯ APARTAMENTO	106
КАСТРЮЛЯ ГЛУБОКАЯ COOL • LINE	100
КАСТРЮЛЯ ГЛУБОКАЯ HANDY	30
КАСТРЮЛЯ ГЛУБОКАЯ HOBBY CHEF	104
КАСТРЮЛЯ ГЛУБОКАЯ IDEA	103
КАСТРЮЛЯ ГЛУБОКАЯ TOP LINE	18-19
КАСТРЮЛЯ ГЛУБОКАЯ АЛЮМИНИЕВАЯ	33-34
КАСТРЮЛЯ ДЛЯ КУС-КУСА	26
КАСТРЮЛЯ ДЛЯ МАКАРОННЫХ ИЗДЕЛИЙ	220
КАСТРЮЛЯ ИЗ ЛИТОГО АЛЮМИНИЯ	96
КАСТРЮЛЯ ПАРОВАРКА ИЗ НЕРЖАВЕЮЩЕЙ СТАЛИ	26
КАСТРЮЛЯ ПАЭЛЬЯ HANDY	31
КАСТРЮЛЯ ПАЭЛЬЯ HOBBY CHEF	104
КАСТРЮЛЯ ПАЭЛЬЯ INOX-PRO	24-25
КАСТРЮЛЯ ПАЭЛЬЯ PUJADAS 1921	93
КАСТРЮЛЯ ПАЭЛЬЯ TOP LINE	18-19
КАСТРЮЛЯ ПАЭЛЬЯ АЛЮМИНИЕВАЯ	43
КАСТРЮЛЯ ПАЭЛЬЯ ВАЛЕНСИЙСКАЯ	48

Артикул	Страница
КАСТРЮЛЯ ПАЭЛЬЯ ИЗ СТАЛИ, ЭМАЛИРОВАННАЯ	48
КАСТРЮЛЯ ПАЭЛЬЯ, ЭМАЛИРОВАННАЯ, ДЛЯ ГАЗОВОЙ ПЛИТЫ	49
КАСТРЮЛЯ С КРАНОМ	27
КАСТРЮЛЯ СЕРИИ BLACK	96
КАСТРЮЛЯ-СОУСНИК APARTAMENTO	106
КАСТРЮЛЯ-СОУСНИК ИЗ НЕРЖАВЕЮЩЕЙ СТАЛИ	29
КАСТРЮЛЯ-СОУСНИК КОНИЧЕСКИЙ	21, 29, 31, 35, 99, 364
КАСТРЮЛЯ-СОУСНИК ФРАНЦУЗСКОГО ТИПА	20, 29
КИСТОЧКА	109, 369
КИТАЙСКИЙ ДУРШЛАГ	70
КОВРИКИ	326-327
КОЛОКОЛ ДЛЯ ДЕСЕРТОВ	372
КОЛЬЦО	385
КОЛЬЦО ДЛЯ БУТЫЛКИ ВИНА	319
КОНТЕЙНЕР ДЛЯ МУКИ	71
КОНТЕЙНЕР ДЛЯ ПРИБОРОВ	151, 155, 165, 252, 289, 352
КОРЗИНА ДЛЯ БОЛЬШИХ ПОДНОСОВ	145
КОРЗИНА ДЛЯ ИЗОТЕРМИЧЕСКИХ ПОДНОСОВ	145
КОРЗИНКА ДЛЯ ПРИБОРОВ	142
КОРЗИНКА ДЛЯ ПРИБОРОВ	142
КОРЗИНЫ ДЛЯ ТАРЕЛОК	143-145
КОРЗИНЫ ЗАКРЫТЫЕ	140-141
КОРЗИНЫ ОТКРЫТЫЕ	138-139, 142
КОРЗИНЫ ПОЛИПРОПИЛЕНОВЫЕ	282-289
КОРОБКА ДЛЯ ПРИПРАВ	318
КОТЕЛ	364-365
КОФЕЦНИЦА	321-323
КРЫШКА GN	121, 125, 129, 131, 132, 133
КРЫШКА POLINORM®	121, 125, 129, 131, 132
КРЫШКА ДЛЯ КАСТРЮЛЬ	21, 27, 31, 35, 105
КРЫШКА ДЛЯ КОРЗИНЫ	142
КРЫШКА ИЗ НЕРЖАВЕЮЩЕЙ СТАЛИ	27
КРЫШКА НА ЧАШКУ ДЛЯ ЗАВТРАКА	354
КРЮЧОК	72, 356
КУВШИН	339-340
КУВШИН-ТЕРМОС	339
КУХОННЫЙ НАБОР ИЗ 5-ТИ ПРЕДМЕТОВ	264
КУХОННЫЙ НАБОР ИЗ 8-МИ ПРЕДМЕТОВ NOBBY CHEF	105
КУХОННЫЙ ПРОЦЕССОР	191-195
ЛАМПА ПОДОГРЕВА	231-232
ЛЕЙКА ДЛЯ МАСЛА	75
ЛЕНТА КОНДИТЕРСКАЯ ИЗ ПВХ ДЛЯ МУССА	385
ЛИМОНОВЫЖИМАЛКА	318
ЛОЖКА	60, 107-108, 409, 264-269, 309, 318
ЛОЖКА ДЛЯ СМАЗКИ	64, 66, 110
ЛОЖКА КОКТЕЙЛЬНАЯ	318
ЛОПАТКА ДЛЯ КАРТОФЕЛЬНЫХ ЧИПСОВ	63
ЛОПАТКА ДЛЯ МОРОЖЕНОГО	376
ЛОПАТКА ДЛЯ ПИЦЦЫ	56
ЛОПАТКА ДЛЯ РЫБЫ	59, 109, 64-64
ЛОПАТКА ДЛЯ СБОРА ОВОЩЕЙ	81
ЛОПАТКА ДЛЯ СЫРА	110
ЛОПАТКА ДЛЯ ТОРТОВ	107-108, 64, 66, 110
ЛОПАТКА ДЛЯ ФАСТ-ФУДА	64-66
ЛОПАТКА	59, 107-108, 64, 264-269, 367
ЛОТКИ ДЛЯ МОРОЖЕНОГО	377

Артикул	Страница
МАНДОЛИНЫ	73
МАШИНА "VERSATIL MACHINE"	78
МАШИНА ДЛЯ ВЫЖИМАНИЯ	209
МЕЛАМИНОВАЯ ПОСУДА ДЛЯ ПРЕЗЕНТАЦИИ	290-311, 332
МЕЛКИ ДЛЯ ОТМЕТОК	359
МЕЛЬНИЦА ДЛЯ ПЕРЦА	342
МЕЛЬНИЦА ДЛЯ СОЛИ	342
МЕНЗУРКА	82
МЕРНЫЕ ЛОЖКИ	82
МЕШКИ КОНДИТЕРСКИЕ	390
МИКРОВОЛНОВАЯ ПЕЧЬ	224
МИНИАТЮРЫ ИЗ МЕЛАМИНА	332
МИНИАТЮРЫ ИЗ НЕРЖ.СТАЛИ	330-331
МИНИАТЮРЫ ЧУГУННЫЕ	334-335
МИСКА КОНИЧЕСКАЯ	356
МОЛОЧНИК	321-323
МОРОЖЕНИЦА	188-191
МОРОЖЕНОЕ	188-191, 376-377
МРАМОРНАЯ ПОДСТАВКА ДЛЯ ПРЕЗЕНТАЦИИ	292
НАБОР КАСТРЮЛЬ IDEA	102-103
НАБОРЫ CUBIC	246-249
НАБОРЫ ДЛЯ СПЕЦИЙ	74
НАКАЛЫВАТЕЛЬ ДЛЯ ЗАМЕТОК	343
НАСАДКА	391-394
НАСАДКА ИЗ ПОЛИКАРБОНАТА	394
НАСТЕННЫЙ ДЕРЖАТЕЛЬ ДЛЯ ИНВЕНТАРЯ С 5-Ю КРЮКАМИ	265-268
НАСТОЛЬНАЯ ПОДСТАВКА ПОД ПОДНОС ДЛЯ МОРЕПРОДУКТОВ	342
НАТУРАЛЬНЫЙ БАМБУК И ДЕРЕВО	280-281
НОЖ	265-267, 265-267
НОЖ / ЗАПАСНОЙ ВАЛИК	78
НОЖ ДЛЯ НАРЕЗКИ КАРТОФЕЛЯ ФРИ	77-78
НОЖ ДЛЯ НАРЕЗКИ ОВОЩЕЙ	192
НОЖ ДЛЯ РЕЗКИ ТОМАТОВ	73
НОЖ ДЛЯ РЕЗКИ ШАРИКОВ	111
НОЖ ДЛЯ РЕЗКИ ЯБЛОК И ВЫЕМКИ СЕРДЦЕВИНЫ	110, 77-78
НОЖ ДЛЯ РЕЗКИ ЯИЦ	77
НОЖ ДЛЯ СРЕЗАНИЯ ФОЛЬГИ	319
НОЖ ДЛЯ ЧИСТКИ КАРТОФЕЛЯ	111
НОЖКА ПОД ВЕДРО ДЛЯ ЛЬДА НА 3 БУТЫЛКИ	317
НОЖКА С ПРИСТАВКОЙ ДЛЯ ВЕДЕР	317
НОМЕРА ДЛЯ СТОЛОВ	341
ОВАЛЬНОЕ БЛЮДО	272, 304-305
ОВАЛЬНЫЙ ПОДНОС	343
ОДНОРАЗОВАЯ ПОСУДА	347-351
ОСНОВА ДЛЯ ПИЦЦЫ	55
ОТКРЫВАЛКА ПРОМЫШЛЕННАЯ	78
ОХЛАДИТЕЛЬ БУТЫЛОК ДЛЯ БУФЕТА CUBIC	265
ОХЛАДИТЕЛЬНАЯ ПАНЕЛЬ	273
ОХЛАДИТЕЛЬНЫЙ ЧЕХОЛ	316
ОХЛАДИТЕЛЬНЫЙ ШКАФ ДЛЯ БУТЫЛОК	233
ПАЛОЧКИ	311
ПАРОВАРКА	225-226, 274-275
ПАРОВАРКА COOL • LINE	101
ПАРОВАРКА GASTRONORM	225
ПАРОВАРКА NOBBY CHEF	105
ПЕПЕЛЬНИЦА	344

Артикул	Страница
ПЕРФОРИРОВАННОЕ ДНО GASTRONORM	124-125, 129, 131, 161
ПИАЛА	297-298, 298-300, 305-311, 310-311, 354
ПИЛА КУХОННАЯ	66, 76
ПИСТОЛЕТ КОНДИТЕРСКИЙ	389
ПЛАСТМАССОВОЕ ВЕДРО ДЛЯ ЛЬДА	316
ПЛОСКАЯ СКОВОРОДА-ГРИЛЬ С АЛЮМИНИЕВЫМИ РУЧКАМИ	97
ПОДНОС	52-55, 145, 163-164, 272, 299-300, 300-305, 325, 352-354
ПОДНОС GASTRONORM	52
ПОДНОС ДЛЯ МОРЕПРОДУКТОВ	342
ПОДНОС ДЛЯ ПРЕЗЕНТАЦИИ	303
ПОДНОС ДЛЯ ПРИБОРОВ	353, 252
ПОДНОС ДЛЯ САМООБСЛУЖИВАНИЯ ИЗ НЕРЖ. СТАЛИ	353
ПОДНОС ИЗОТЕРМИЧЕСКИЙ	354
ПОДНОС КОНДИТЕРСКИЙ	375, 52-54
ПОДНОС ОФИЦИАНТА	325
ПОДНОС ФАСТ-ФУД	352
ПОДНОСЫ SUBIC	243-245, 248-249, 251-252
ПОДОГРЕВАТЕЛЬ ТАРЕЛОК	230-232
ПОДСАЛФЕТНИК	345
ПОДСТАВКА ДЛЯ КРЫШЕК GN	126
ПОДСТАВКА ДЛЯ ПИЦЦЫ	56
ПОДСТАВКА ДЛЯ ПОДНОСОВ БОЛЬШОГО РАЗМЕРА	343
ПОДСТАВКА ДЛЯ ТОРТА	373
ПОДСТАВКА ДЛЯ ШПАЖЕК SUBIC	244-245
ПОДСТАВКА ПОД ВЕДРО ДЛЯ ШАМПАНСКОГО	316
ПОЛКИ	168-185
ПОРЦИОННАЯ ЛОЖКА ДЛЯ МОРОЖЕНОГО	376
ПРЕЗЕНТАЦИОННАЯ ВИТРИНА	263
ПРЕЗЕНТАЦИОННАЯ ЛОПАТКА	291-292
ПРЕЗЕНТАЦИОННАЯ ПОДСТАВКА ДЛЯ ШПАЖЕК SUBIC	244-245
ПРЕСС ДЛЯ ЧЕСНОКА	111, 77
ПРОБКА ДЛЯ ШАМПАНСКОГО	319
ПЮРЕШНИЦА	72
РАЗДЕЛИТЕЛЬ ДЛЯ КАСТРЮЛИ С КРАНОМ	27
РАЗДЕЛИТЕЛЬНЫЕ ПРОФИЛИ	120, 123
РАМКИ ДЛЯ ПОДНОСОВ	53
РАСПРЕДЕЛИТЕЛЬ ДЛЯ СОКА	250
РЕГУЛИРУЕМАЯ ТЕЛЕЖКА ДЛЯ ТАРЕЛОК	167
РЕШЕТКИ GN	54
РЕШЕТКИ КОНДИТЕРСКИЕ	54, 375
РИСОВАРКА	220
РОЛИК ДЛЯ НАРЕЗКИ ПИЦЦЫ	64
РУКАВИЦА	86-87
САЛАТНИЦА АКРИЛЛОВАЯ	273
САЛАТНИЦА ДЛЯ ЛЬДА	316
САЛФЕТНИЦА SUBIC	253
САХАРНИЦА	321-323
СЕРИИ BLACK	94-97
СЕРИЯ GASTRONORM ИЗ ПОЛИКАРБОНАТА	128-129
СЕРИЯ GASTRONORM С УТОЛЩЕННЫМ ДНОМ СЭНДВИЧ	127
СЕРИЯ ALU-PRO	32-35
СЕРИЯ APARTAMENTO	106
СЕРИЯ FLAP-RACK®	136-147, 144-147
СЕРИЯ GASTRONORM ИЗ ПОЛИПРОПИЛЕНА	132-133
СЕРИЯ GASTRONORM, НЕРЖ. СТАЛЬ	122-127
СЕРИЯ HANDY	30-31

Артикул	Страница
СЕРИЯ NOBBY CHEF	104-105
СЕРИЯ INOX-PRO	22-29
СЕРИЯ MULTIMETAL	98-99
СЕРИЯ PUJADAS 1921. ЧУГУН СВЕРХЛЕГКИЙ ДЛЯ ИНДУКЦИОННЫХ ПЛИТ ...	92-93
СЕРИЯ TOP LINE	18-21
СИЛИКОНОВАЯ БУМАГА	56
СИЛИКОНОВАЯ КАСТРЮЛЬКА CO-COTTE	112
СИЛИКОНОВАЯ САЛФЕТКА	87
СИЛИКОНОВАЯ САЛФЕТКА	56
СИТЕЧКО-ШАРИК ДЛЯ ЗАВАРИВАНИЯ ТРАВЯНОГО ЧАЯ	324
СИТО	373
СКАЛКА ДЛЯ ТЕСТА	369
СКОВОРОДА "LYONNAISE"	47
СКОВОРОДА IDEA	103
СКОВОРОДА MULTIMETAL	99
СКОВОРОДА PUJADAS 1921	93
СКОВОРОДА АЛЮМИНИЕВАЯ	42-44, 106
СКОВОРОДА АЛЮМИНИЕВАЯ	95-97
СКОВОРОДА ГЛУБОКАЯ, ЭМАЛИРОВАННАЯ, С РУЧКАМИ	48
СКОВОРОДА ГРИЛЬ	51, 96-97, 99
СКОВОРОДА ДЛЯ БЛИНОВ	44
СКОВОРОДА ДЛЯ ФРАНЦУЗСКИХ БЛИНОВ	44, 47, 97
СКОВОРОДА СЕРИИ BLACK	95, 97
СКОВОРОДА, НЕРЖ. СТАЛЬ	46
СКОВОРОДЫ	38-49, 93, 95, 99, 106
СКРЕБОК	64-66, 76, 370
СКРЕБОК ДЕКОРАТИВНЫЙ	370
СКРЕБОК ДЛЯ СБОРА КРОШЕК	341
СКРЕБОК ДЛЯ ЧИСТКИ РЫБЫ	76
СЛАНЦЕВО-МРАМОРНАЯ ПОДСТАВКА ДЛЯ ПРЕЗЕНТАЦИИ	292
СЛАНЦЕВЫЕ ДОСКИ ДЛЯ ПРЕЗЕНТАЦИИ	292, 336-337
СОВОК	365
СОСУД ДЛЯ СОУСОВ	308
СОТЕЙНИК HANDY	31
СОТЕЙНИК NOBBY CHEF	105
СОТЕЙНИК MULTIMETAL	99
СОТЕЙНИК АЛЮМИНИЕВЫЙ	35
СОТЕЙНИК ИЗ НЕРЖАВЕЮЩЕЙ СТАЛИ	28
СОУСНИК	342
СОУСНИК / НАБОР ДЛЯ ЗАКУСКИ	342
СОУСНИК COOL • LINE	101
СОУСНИК HANDY	31
СОУСНИК NOBBY CHEF	105
СОУСНИК IDEA	103
СОУСНИК АЛЮМИНИЕВАЯ	35
СТАКАН	355
СТЕНД ДЛЯ ГАСТРОЕМОСТЕЙ GN	126, 296
СТОЛ ДЛЯ НАРЕЗКИ	81
СТОЛИК БУФЕТНЫЙ SUBIC	253, 261
СУПНИЦА	272
ТАБЛИЧКА "ЗАРЕЗЕРВИРОВАНО"	341
ТАБЛИЧКА "НЕ КУРИТЬ"	341
ТАРЕЛКИ	298-299, 303, 308-311, 354
ТАРЕЛОЧКА ДЛЯ СДАЧИ	346
ТВЕРДАЯ КРЫШКА ДЛЯ ПРЯМОУГОЛЬНОГО БЛЮДА	354

Артикул	Страница
ТЕЛЕЖКА GUERIDON	150-151
ТЕЛЕЖКА ДВОЙНАЯ ДЛЯ ПОДНОСОВ ФАСТ-ФУД	163
ТЕЛЕЖКА ДЕРЕВЯННАЯ	148-151
ТЕЛЕЖКА ДЛЯ ГАСТРОЕМКОСТЕЙ GASTRONORM	157, 158, 161
ТЕЛЕЖКА ДЛЯ КОРЗИНОК	166
ТЕЛЕЖКА ДЛЯ ПРИБОРОВ	151, 165, 352
ТЕЛЕЖКА ДЛЯ РАЗМОРАЖИВАНИЯ	161
ТЕЛЕЖКА ДЛЯ РАЗМОРАЖИВАНИЯ GASTRONORM	161
ТЕЛЕЖКА ДЛЯ СБОРА ПОСУДЫ	155
ТЕЛЕЖКА ДЛЯ ТЯЖЕЛЫХ ГРУЗОВ	165
ТЕЛЕЖКА ОПРОКИДНАЯ	157
ТЕЛЕЖКА ПЛАСТМАССОВАЯ	152, 166-167
ТЕЛЕЖКА С НАПРАВЛЯЮЩИМИ	157-166
ТЕЛЕЖКА С НАПРАВЛЯЮЩИМИ ДЛЯ ДУХОВКИ	162
ТЕЛЕЖКА С НАПРАВЛЯЮЩИМИ, РАЗБОРНАЯ	158-163
ТЕЛЕЖКА С РАБОЧЕЙ ПОВЕРХНОСТЬЮ	165
ТЕЛЕЖКА СЕРВИРОВОЧНАЯ АЛЮМИНИЕВАЯ	152
ТЕЛЕЖКА СЕРВИРОВОЧНАЯ ИЗ НЕРЖ. СТАЛИ	153-155
ТЕЛЕЖКА СЕРВИРОВОЧНАЯ РАЗБОРНАЯ	154
ТЕЛЕЖКА ШПИЛЬКА	159-160
ТЕПЛОЙ ШКАФ	228-230
ТЕРКА	67-68, 110
ТЕРМОМЕТР	84-85
ТЕРМОС С ДОЗАТОРОМ	339
ТОСТЕР	214-217
ТОЧИЛО ДЛЯ НОЖЕЙ	209
ТРЕНОЖНИК ДЛЯ КАСТРЮЛИ ПАЭЛЬЯ	49
ТЯПКА ДЛЯ ОТБИВАНИЯ МЯСА	75
УКОМПЛЕКТОВАННЫЕ НАБОРЫ ПОЛОК	174-185
УНИВЕРСАЛЬНАЯ КОНЗИНКА	142
УНИВЕРСАЛЬНАЯ ПРОБКА	319
УНИВЕРСАЛЬНЫЙ НОЖ ДЛЯ ЧИСТКИ	111
УЧРЕЖДЕНИЯ	352-359
ФОНТАН ДЛЯ ШОКОЛАДНОГО ФОНДЮ	226
ФОРМА ГНЕЗДО	61
ФОРМА ДЛЯ ВЫПЕЧКИ "СЛЕЗА"	386
ФОРМА ДЛЯ ВЫПЕЧКИ "КАПЛЯ"	386
ФОРМА ДЛЯ ВЫПЕЧКИ "КЕЙК"	398, 378, 388
ФОРМА ДЛЯ ВЫПЕЧКИ "СЕРДЦЕ"	386
ФОРМА ДЛЯ ВЫПЕЧКИ ОВАЛЬНАЯ	386
ФОРМА ДЛЯ ВЫПЕЧКИ ПОЛУСФЕРА	388
ФОРМА ДЛЯ ВЫПЕЧКИ ШЕСТИУГОЛЬНАЯ	386
ФОРМА ДЛЯ ПИЦЦЫ	55
ФОРМА ДЛЯ РУЛЕТА	388
ФОРМА ДЛЯ ЯЙЦА	75
ФОРМА КВАДРАТ ВЫПУКЛАЯ	387
ФОРМА ТРЕУГОЛЬНИК ВЫПУКЛАЯ	384
ФОРМА-СТАКАНЧИК ДЛЯ ФЛАНА	380, 387, 398
ФОРМЫ ДЛЯ ВЫПЕЧКИ "FLEXIRAN"	403-411
ФОРМЫ ДЛЯ ВЫПЕЧКИ СИЛИКОНОВЫЕ	395-402
ФОРМЫ ДЛЯ ВЫРЕЗАНИЯ ТЕСТА	368, 384
ФОРМЫ ДЛЯ ШОКОЛАДА	399
ФОРМЫ КОНДИТЕРСКИЕ	378-382, 385-388, 395-402, 403-411
ФОРМЫ СИЛИКОНОВЫЕ 600 X 400	400-402
ФРИТЮРНИЦА	212-213
ХЛЕБНИЦА	284-285, 309

Артикул	Страница
ЦИФРОВЫЕ КУХОННЫЕ ЧАСЫ	84
ЧАЙНИК	321-324
ЧАЙНИЧЕК ДЛЯ ТРАВЯНОГО ЧАЯ	324
ЧАФИНГДИШ	274-279
ЧАША	309-310, 354
ЧАША ДЛЯ МОРОЖЕНОГО	376
ШАБЛОН ДЛЯ НАРЕЗКИ ДОЛЕК	111
ШАМПУР / ПАЛОЧКА	343
ШЕЙКЕР	318
ШТОПОР	110
ШТОПОР	319
ШУМОВКА	59, 61, 107-108, 264-269
ШУМОВКА СЕТЧАТАЯ	61
ЩЕТКА	76
ЩИПЦЫ	62-63, 107-109, 270-271, 318
ЩИПЦЫ ДЛЯ БУФЕТА	63, 270
ЩИПЦЫ ДЛЯ ВЫПЕЧКИ	270
ЩИПЦЫ ДЛЯ ДУХОВКИ	56
ЩИПЦЫ ДЛЯ КОЛБАСНЫХ ИЗДЕЛИЙ	270-271
ЩИПЦЫ ДЛЯ КОЛКИ ОРЕХОВ	271
ЩИПЦЫ ДЛЯ МОРЕПРОДУКТОВ	271
ЩИПЦЫ С КОЛЬЦАМИ	270
ЩИПЦЫ СЕРВИРОВОЧНЫЕ	62
ЭЛЕКТРИЧЕСКАЯ КАСТРЮЛЯ	279
ЭЛЕКТРИЧЕСКАЯ ЛАМПА	372
ЭЛЕКТРИЧЕСКИЙ ЭЛЕМЕНТ ДЛЯ ЧАФИНДИША	278
ЭЛЕКТРИЧЕСКИЙ ГЛИЛЬ	219
ЭЛЕКТРИЧЕСКИЙ СЛАЙСЕР ДЛЯ КОЛБАСНЫХ ИЗДЕЛИЙ	192
ЯЩИК ДЛЯ ПРИБОРОВ ДЛЯ СЕРВИРОВОЧНОЙ ТЕЛЕЖКИ	155

REF.	Pag.	REF.	Pag.	REF.	Pag.	REF.	Pag.	REF.	Pag.	REF.	Pag.
100002	126	100531	281	100753	285	100931	289	110552	124	115000	161
100003	126	100540	281	100754	285	100932	289	110651	122	115000	123
100004	126	100541	281	100755	285	100940	289	110652	124	115020	33
100005	126	100542	281	100760	285	100950	289	1106BF	130	115024	33
100006	126	100543	281	100761	285	100951	289	1106C1	128	115028	33
100007	126	100544	281	100770	285	100955	289	1106F1	127	115032	33
100008	126	100550	281	100780	285	100960	289	1106P1	132	115040	33
100100	347	100551	281	100781	285	100965	289	111001	122	115050	33
100101	347	100552	281	100790	286	100970	289	111002	124	115060	33
100102	347	100553	281	100791	286	100971	289	1110BF	130	1150BF	131
100103	347	100554	281	100792	286	103016	35	1110C1	128	1150C1	129
100104	348	100570	281	100793	286	103018	35	1110F1	127	1150P1	133
100105	348	100571	281	100800	286	103020	35	1110F2	127	115132	34
100106	348	100572	281	100801	286	103022	35	1110P1	132	115140	34
100107	348	100600	281	100802	286	103024	35	111111	123	115150	34
100108	348	100601	281	100803	286	103028	35	111501	122	115160	34
100109	348	100630	282	100804	286	104016	35	111502	124	116025	34
100110	349	100631	282	100805	286	104018	35	1115BF	130	116030	34
100111	349	100640	282	100810	286	104020	35	1115C1	128	116035	34
100112	349	100650	282	100811	286	104022	35	1115F1	127	116040	34
100113	349	100660	282	100812	286	104024	35	1115F2	127	116045	34
100114	349	100661	282	100813	286	104026	35	1115P1	132	116050	34
100115	349	100662	282	100814	286	106020	35	112001	122	116060	34
100117	349	100670	282	100815	286	106024	35	112002	124	116125	33
100118	349	100671	282	100820	286	106028	35	112020	35	116130	33
100119	349	100672	282	100821	286	106032	35	112025	35	116135	33
100120	350	100673	282	100822	286	106040	35	112027	35	116140	33
100121	350	100674	282	100830	287	107040	365	112030	35	116145	33
100122	350	100680	282	100831	287	107050	365	112032	35	116150	33
100123	350	100681	282	100840	287	107060	365	112035	35	116160	33
100124	350	100682	282	100841	287	109030	71	112038	35	117025	34
100125	350	100683	282	100842	287	109035	71	112040	35	117027	34
100126	350	100684	282	100850	287	109040	71	112045	35	117030	34
100127	350	100690	283	100851	287	109045	71	112050	35	117032	34
100128	350	100691	283	100860	287	109050	71	112060	35	117035	34
100129	350	100692	283	100861	287	110000	125	1120C1	128	117038	34
100130	351	100693	283	100862	287	110001	125	1120P1	132	117040	34
100131	351	100700	283	100870	287	110002	125	113030	51	117045	34
100132	351	100701	283	100871	287	110004	125	113035	51	117050	34
100133	351	100702	283	100872	287	110005	125	113040	51	117060	34
100134	351	100710	283	100880	288	1100BF	131	113045	51	117125	33
100135	351	100711	283	100881	288	1100C1	129	113050	51	117127	33
100136	351	100712	283	100882	288	1100C1	133	113055	51	117130	33
100500	280	100713	283	100890	288	1100P1	125	113060	51	117132	33
100501	280	100714	283	100891	288	1100P1	129	113065	51	117135	33
100502	280	100720	283	100892	288	1100P1	131	113070	51	117138	33
100503	280	100730	283	100900	288	1100P1	132	114040	51	117140	33
100510	280	100731	283	100901	288	110201	259	114045	51	117145	33
100511	280	100740	284	100902	288	110201	122	114050	51	117150	33
100512	280	100741	284	100910	288	110202	124	114060	51	117160	33
100520	280	100742	284	100911	288	110401	122	114070	51	118020	34
100521	280	100750	285	100920	288	110402	124	114540	51	118025	34
100522	280	100751	285	100921	288	1104F1	127	114545	51	118027	34
100530	281	100752	285	100930	289	110551	122	114550	51	118030	34

REF.	Pag.	REF.	Pag.	REF.	Pag.	REF.	Pag.	REF.	Pag.	REF.	Pag.
118032	34	121001	122	128120	42	132040	53	141028	96	15024	225
118035	34	121002	124	128124	42	132060	53	141032	96	15025	225
118040	34	1210BF	130	128128	42	1320BF	130	141036	96	15026	230
118045	34	1210C1	128	128132	42	1320C1	128	141040	96	15027	230
118050	34	1210F1	127	128220	42	1320P1	133	1410BF	131	15028	230
118060	34	1210F2	127	128224	42	132140	54	1410C1	129	15029	232
118120	33	1210P1	132	128228	42	132160	54	1410P1	133	15030	232
118125	33	121501	122	128232	42	132240	54	14126	144	15031	231
118127	33	121502	124	128320	42	132260	54	14126F1	144	15032	231
118130	33	1215BF	130	128324	42	132365	52	141501	123	15033	232
118132	33	1215C1	128	128328	42	132560	52	1415BF	131	15034	232
118135	33	1215F1	127	128332	42	135000	123	1415C1	129	15035	223
118140	33	1215F2	127	128420	42	1350BF	131	1415P1	133	15036	220
118145	33	1215P1	132	128424	42	1350C1	129	142000	97	15038	215
118150	33	122001	122	128428	42	1350P1	133	142001	123	15039	215
118160	33	122002	124	128432	42	135120	47	142100	95	15040	216
120000	125	122040	51	128920	44	135124	47	145000	123	15041	216
120001	125	122050	51	128924	44	135128	47	1450BF	131	15042	214
120002	125	122060	51	128928	44	135132	47	1450C1	129	15043	214
120004	125	1220C1	128	128932	44	135136	47	1450P1	133	15044	220
120005	125	1220P1	132	130000	125	135140	47	148020	43	15060	225
120018	42	122222	123	130001	125	135330	47	148024	43	15061	225
120020	42	123040	53	130002	125	135424	47	148028	43	15070	212
120022	42	123060	53	130004	125	136006	387	148032	43	15071	212
120024	42	123140	53	1300BF	131	136007	387	149120	95	15072	222
120026	42	123160	53	1300C1	129	136008	387	149124	95	15073	232
120028	42	123240	53	1300C1	133	139012	44	149128	95	15074	232
120032	42	123260	53	1300P1	125	140000	125	149130	95	15075	227
120036	42	124020	43	1300P1	129	140001	125	149228	95	15076	227
120040	42	124024	43	1300P1	131	140002	125	149330	95	15077	222
1200BF	131	124028	43	1300P1	132	140004	125	15000	212	15078	222
1200C1	129	124032	43	130201	122	140018	43	15001	212	15079	222
1200C1	133	124036	43	130202	124	140020	43	15002	212	15080	224
1200P1	125	124040	43	130401	122	140024	43	150028	97	15084	219
1200P1	129	125000	123	130402	124	140028	43	15003	212	15086	219
1200P1	131	125038	43	130651	122	140032	43	15004	218	15089	192
1200P1	132	1250BF	131	130652	124	140036	43	15005	218	15090	192
120201	122	1250C1	129	1306BF	130	140040	43	15006	218	15091	192
120401	122	1250P1	133	1306C1	128	1400BF	131	15007	218	15095	192
1204F1	127	127020	43	1306P1	133	1400C1	129	15008	218	15096	226
120651	122	127024	43	131001	122	1400C1	133	15009	218	15097	226
120652	124	127028	43	131002	124	1400P1	125	15010	226	151012	332
1206BF	130	127032	43	131022	44	1400P1	129	15011	226	151014	332
1206C1	128	127036	43	131026	44	1400P1	131	150128	95	151016	96
1206F1	127	127040	43	1310BF	130	1400P1	132	15014	225	151020	96
1206P1	132	128018	42	1310C1	128	140201	123	15015	225	151024	96
120820	44	128020	42	1310P1	133	140651	123	15016	225	151028	96
120824	44	128022	42	131501	122	1406BF	131	15017	225	151032	96
120828	44	128024	42	131502	124	1406C1	129	15018	225	15105	144
120832	44	128026	42	1315BF	130	1406P1	133	15019	225	15105F1	144
120920	44	128028	42	1315C1	128	141001	123	15020	225	152025	97
120924	44	128032	42	1315P1	133	141016	332	15021	225	152030	97
120928	44	128036	42	132001	122	141020	96	15022	225	152035	97
120932	44	128040	42	132002	124	141024	96	15023	225	153025	97

REF.	Pag.	REF.	Pag.	REF.	Pag.	REF.	Pag.	REF.	Pag.	REF.	Pag.
153034	97	1906BF	131	20043	346	205035	24	209060	27	213032	46
153050	97	1906C1	129	20050	346	205040	24	209070	27	213036	46
155032	96	1906P1	133	20066	346	205045	24	21000	358	213040	46
160000	125	19100	356	20069	346	205050	24	21001	358	214016	20
160001	125	191001	123	20072	253	205060	24	210016	28	214016	29
160002	125	19101	356	201016	20	206016	25	210018	28	214018	20
160004	125	19102	356	201016	29	206018	25	210020	28	214018	29
1600BF	131	19103	357	201018	20	206020	25	21003	358	214020	20
1600C1	129	19104	357	201018	29	206024	25	21004	358	214020	29
1600C1	133	19105	357	201020	20	206028	25	21005	358	214022	20
1600P1	125	19106	357	201020	29	206030	25	21006	358	214022	29
1600P1	129	19107	357	201024	20	206032	25	21007	358	214024	20
1600P1	131	19108	357	201024	29	206035	25	21008	358	214024	29
1600P1	132	19109	356	201028	20	206040	25	21013	358	215000	161
160651	123	1910BF	131	201028	29	206045	25	21014	358	215000	123
1606BF	131	1910C1	129	201032	20	206050	25	21015	359	215020	25
1606C1	129	1910P1	133	201032	29	206060	25	21016	359	215024	25
1606P1	133	19110	356	20115	144	207016	25	21017	359	215028	25
161001	123	19111	357	20115F1	144	207018	25	21020	359	215030	25
1610BF	131	19112	357	202016	20	207020	25	210201	122	215032	25
1610C1	129	19113	356	202016	29	207024	25	210202	124	215035	25
1610P1	133	19114A	356	202018	20	207028	25	21021	359	215040	25
161501	123	19114N	356	202018	29	207030	25	21022	359	215045	25
1615BF	131	19114R	356	202020	20	207032	25	21023	359	215050	25
1615C1	129	19115A	357	202020	29	207035	25	21024	359	215060	25
1615P1	133	19115N	357	202024	20	207040	25	21025	359	216016	24
162001	123	19115R	357	202024	29	207045	25	21026	359	216018	24
165024	93	19116	357	202028	20	207050	25	21027	359	216020	24
165030	93	19126	144	202028	29	207060	25	21028	359	216024	24
165034	93	19126F1	144	202032	20	208016	25	21029	359	216028	24
1650BF	131	200012	20	202032	29	208018	25	210401	122	216030	24
1650C1	129	200012	29	203016	28	208020	25	210402	124	216032	24
1650P1	133	200014	20	203018	28	208024	25	210651	122	216035	24
166032	93	200014	29	203020	28	208028	25	210652	124	216040	24
167026	93	200016	20	203024	28	208030	25	211001	122	216045	24
167028	93	200016	29	204020	21	208032	25	211002	124	216050	24
167030	93	200018	20	204020	28	208035	25	211016	28	216060	24
167032	93	200018	29	204024	21	208040	25	211018	28	217016	24
168024	93	200020	20	204024	28	208045	25	211020	28	217018	24
168028	93	200020	29	204028	21	208050	25	21105	144	217020	24
168030	93	200022	20	204028	28	208060	25	21105F1	144	217024	24
169020	93	200022	29	204030	21	209014	27	211501	122	217028	24
169024	93	200024	20	204030	28	209016	27	211502	124	217030	24
169028	93	200024	29	204032	21	209018	27	212001	122	217032	24
169030	93	200028	20	204032	28	209020	27	212002	124	217035	24
190000	125	200028	29	204035	21	209022	27	212016	28	217040	24
1900BF	131	200116	29	204035	28	209024	27	212018	28	217045	24
1900C1	129	200120	29	204040	21	209028	27	212020	28	217050	24
1900C1	133	200320	21	204040	28	209030	27	213018	46	217060	24
1900P1	125	200320	29	205020	24	209032	27	213020	46	218016	24
1900P1	129	200324	21	205024	24	209035	27	213022	46	218018	24
1900P1	131	200324	29	205028	24	209040	27	213024	46	218020	24
1900P1	132	20041	346	205030	24	209045	27	213026	46	218024	24
190651	123	20042	346	205032	24	209050	27	213028	46	218028	24

REF.	Pag.	REF.	Pag.	REF.	Pag.	REF.	Pag.	REF.	Pag.	REF.	Pag.
218030	24	22040	293	22087	293	22172	306	22273	300	23009	324
218032	24	22041	294	22088	308	22173	306	22274	300	23010	324
218035	24	22042	293	22089	293	22174	307	22275	300	23015	324
218040	24	22043	294	22090	303	22175	307	223035	27	230201	122
218045	24	22044	293	22091	301	22176	307	223040	27	230202	124
218050	24	22045	294	22092	301	22177	305	224023	27	230401	122
218060	24	22046	293	22097	309	22178	309	224026	27	230402	124
219016	28	22047	294	22098	309	22179	309	22500	304	230651	122
219018	28	22048	293	22099	307	22180	309	22501	304	230652	124
219020	28	22049	294	22100	305	22181	309	22502	304	231001	122
22000	301	22050	293	22101	305	22182	310	22600	291	231002	124
22001	301	22051	294	22102	305	22183	310	22601	291	231501	122
220018	45	22052	293	22103	304	22184	310	22602	291	231502	124
22002	303	22053	294	22104	308	22185	344	22603	291	232001	122
220020	45	22054	293	22105	308	22187	311	22604	291	232002	124
220021	303	22055	295	22106	308	22188	311	22605	291	233024	99
220022	45	22056	295	22107	308	22190	311	22606	291	233028	99
220023	303	22057	295	22108	307	22191	311	22610	292	233032	99
220024	45	22058	295	22109	307	22192	311	22611	292	233124	99
220026	45	22059	295	22110	309	22193	311	22612	292	233128	99
220028	45	22060	295	22111	310	22194	311	22613	292	233132	99
22003	303	22061	295	22112	310	22195	311	22614	292	234016	99
220031	303	22062	295	22113	310	22196	311	22615	292	234018	99
220032	45	22063	295	22114	310	22197	311	22616	292	234020	99
220033	303	22064	295	22115	310	22199	311	22620	291	234024	99
220036	45	22065	295	22116	310	22200	306	22621	291	234028	99
22004	305	22066	295	22117	310	22200A	306	22622	291	23500	334
220040	45	22067	295	22118	310	22200AM	306	22640	292	235000	123
22005	305	22068	295	22123	297	22200N	306	22641	292	23501	334
22006	293	22069	295	22144	292	22200R	306	22642	292	23502	334
22007	293	22070	295	22145	292	22200V	306	22650	291	23503	334
22008	293	22071	295	22150	303	22201	306	22651	291	23504	335
22009	294	22072	295	22151	303	22202	306	22652	291	23505	335
22010	294	22073	295	22152	295	22202A	306	22670	292	23506	335
22011	294	22074	295	22153	295	22202AM	306	22671	292	23507	335
22012	301	22075	295	22154	296	22202N	306	22672	292	23508	335
22013	301	22076	295	22155	296	22202R	306	22890	308	23509	335
22014	301	22077	295	22156	296	22202V	306	22901	298	23550	112
22015	301	22078	295	22157	296	22203	306	22902	298	23551	112
22016	301	22079	293	22158	297	22203A	306	22911	298	23552	112
22017	292	22080	294	22159	295	22203AM	306	22912	298	236020	260
22018	292	22081	293	22160	309	22203N	306	22920	299	237120	101
22019	305	220818	46	22161	260	22203R	306	22930	299	237124	101
22020	305	22082	294	22161	292	22203V	306	22940	299	23800	332
22021	305	220820	46	22162	292	22204	306	22950	299	23801	332
22022	305	220824	46	22163	304	22211	306	22960	298	23802	332
22023	305	220828	46	22164	301	22220	297	22971	298	23803	332
22030	344	22083	293	22165	301	22221	297	22972	298	23804	332
22031	344	220832	46	22166	301	22222	297	230000	125	23805	332
22033	309	220836	46	22167	306	22250	308	230001	125	23806	332
22034	309	22084	294	22168	306	22251	308	23003	324	23810	332
22037	301	220840	46	22169	307	22270	300	23004	324	23811	332
22038	301	22085	303	22170	304	22271	300	23005	49	23812	332
22039	294	22086	303	22171	306	22272	300	23008	324	238120	99

REF.	Pag.	REF.	Pag.	REF.	Pag.	REF.	Pag.	REF.	Pag.	REF.	Pag.
23813	332	248045	27	290128	18	293030	19	303016	70	311071	313
23814	332	24901	331	290130	18	293032	19	303018	70	311072	313
23815	332	24902	331	290132	18	293035	19	303020	70	311335	317
23816	332	249028	27	290135	18	293040	19	303022	70	312000	315
239036	99	249032	27	290140	18	293045	19	303024	70	312100	315
239136	99	249035	27	290145	18	293050	19	303026	70	313025	72
239236	46	249040	27	290150	18	293124	18	303200	70	313030	72
239336	46	249045	27	290160	18	293128	18	303265	58	313126	72
239436	99	25000	345	291016	19	293130	18	304016	364	313132	72
239536	99	25002	345	291020	19	293132	18	304018	364	313200	72
240040	26	25020	345	291024	19	293135	18	304020	364	313500	72
240050	26	251020	99	291028	19	293140	18	304022	364	314110	59
240060	26	251024	99	291030	19	293145	18	304024	364	314112	59
240070	26	251028	99	291032	19	293150	18	305020	105	314210	59
240401	122	251032	99	291035	19	299016	21	305022	105	314212	59
240651	122	26000	326	291040	19	299020	21	306035	364	314300	59
241001	122	26001	326	291045	19	299024	21	307020	364	315010	61
241040	26	26002	326	291050	19	299028	21	307025	364	315012	61
241050	26	26003	327	291060	19	299030	21	307030	364	315015	61
241060	26	26100	327	291116	18	299032	21	307035	364	315017	61
241070	26	269035	51	291120	18	299035	21	307040	364	315020	61
241501	122	270016	106	291124	18	299040	21	307045	364	316025	366
242020	26	270020	106	291128	18	299045	21	307050	364	316030	366
242024	26	270024	106	291130	18	299050	21	307060	364	316035	366
242028	26	270028	106	291132	18	299060	21	307070	364	316040	366
242032	26	271016	106	291135	18	300024	71	307120	364	316045	366
242035	26	271020	106	291140	18	300030	71	307125	364	316050	366
243020	26	271024	106	291145	18	30084	144	307130	364	316125	366
243024	26	271028	106	291150	18	30084F1	144	307135	364	316130	366
243028	26	272014	106	291160	18	301108	58	307140	364	316135	366
243032	26	272016	106	292016	19	301109	58	307145	364	316140	366
243035	26	272018	106	292020	19	301110	58	307150	364	316145	366
244020	26	272020	106	292024	19	301112	58	307230	364	316150	366
244024	26	273024	106	292028	19	301114	58	307240	364	316530	366
244028	26	273028	106	292030	19	301116	58	308030	71	316630	366
244032	26	28202	337	292032	19	301118	58	308035	71	316635	366
244035	26	28252	337	292035	19	301165	58	308040	71	316640	366
24407	331	28302	337	292040	19	301206	58	308045	71	317025	272
24409	331	28303	337	292045	19	301208	58	308050	71	317030	272
24500	331	28403	337	292050	19	301210	58	309035	51	317035	272
24501	331	290016	19	292060	19	301212	58	309040	51	317040	272
24502	331	290020	19	292116	18	301214	58	309050	51	317045	272
24600	331	290024	19	292120	18	301216	58	309060	51	317050	272
24601	331	290028	19	292124	18	302108	59	309070	51	317170	272
24602	331	290030	19	292128	18	302110	59	310000	317	317260	272
24701	331	290032	19	292130	18	302112	59	311001	314	317280	272
24702	331	290035	19	292132	18	302114	59	311002	313	317425	272
24703	331	290040	19	292135	18	302116	59	311003	314	317430	272
24801	331	290045	19	292140	18	302118	59	311004	317	317435	272
24802	331	290050	19	292145	18	302120	59	311006	313	317440	272
248028	27	290060	19	292150	18	302210	59	311020	317	317445	272
248032	27	290116	18	292160	18	302212	59	311051	314	317450	272
248035	27	290120	18	293024	19	302214	59	3110510	260	318005	52
248040	27	290124	18	293028	19	302216	59	311052	314	318040	52

REF.	Pag.	REF.	Pag.	REF.	Pag.	REF.	Pag.	REF.	Pag.	REF.	Pag.
318060	52	331050	376	345000	268	356028	365	367100	267	38550250	189
318100	318	331056	376	346000	267	356032	365	367200	269	386000	64
318211	52	331059	376	346000	268	357000	345	36790250	190	387065	276
319000	318	331066	376	347020	70	358024	63	368000	265	387100	278
319100	318	331070	376	347024	70	358029	63	368000	267	387200	278
32083	145	332010	376	348008	69	358040	63	369000	265	387500	276
32083F1	145	332095	376	348010	69	358230	270	369100	267	388014	318
321020	71	333010	342	348012	69	358231	270	370000	265	388018	318
321022	71	333020	342	348015	69	358232	270	370000	267	389000	271
321024	71	333035	342	348018	69	358237	270	371000	265	390000	77
321026	71	334025	75	349030	339	358241	63	372200	278	390100	77
322101	68	334050	75	349060	339	358242	63	373020	70	391000	67
322102	68	334100	75	349100	339	358243	63	373024	70	392065	58
322103	68	334200	75	350226	373	358244	63	373028	70	393080	366
322104	68	335002	340	350230	373	358245	63	37318	112	393100	366
322201	68	33601	108	350235	373	358246	63	374013	69	393125	366
322202	68	33602	108	350240	373	358247	63	374015	69	394008	61
322203	68	33603	108	350326	373	358301	63	374018	69	394012	61
322204	68	33604	108	350330	373	358302	63	374020	69	395038	60
323050	76	33605	108	350335	373	358303	63	374026	69	396009	58
324013	69	33606	108	350340	373	358304	63	375010	65	396010	58
324016	69	33607	108	350426	373	358305	63	375020	65	396012	58
324019	69	33608	108	350430	373	358306	63	375030	69	397247	60
324022	69	33609	109	350435	373	358307	63	375035	69	397347	61
324025	69	33610	109	350440	373	358401	63	375041	65	398024	367
325008	69	33611	109	350526	373	358402	63	375042	65	398035	367
325010	69	33612	109	350530	373	358403	63	375050	65	398042	367
325012	69	33613	109	350535	373	358404	63	375061	65	398125	367
325015	69	33614	109	350540	373	358405	63	375062	65	398135	367
325018	69	33620	109	350626	373	358406	63	375063	65	398140	367
325020	69	337030	339	350630	373	358407	63	375070	66	398225	367
326000	314	337060	339	350635	373	359000	270	375080	66	398235	367
327000	317	337090	339	350640	373	360000	264	375090	66	398240	367
328020	67	337150	339	350726	373	361000	264	375100	66	398290	367
328023	67	337200	339	350730	373	361100	266	375110	66	399000	318
328600	67	340000	353	350735	373	361200	269	376037	60	399400	318
32902	110	340010	107	350740	373	362000	264	376137	60	399500	318
32903	110	340020	107	351000	271	362100	266	377037	60	399600	318
32904	110	340030	107	351100	271	362200	269	377137	60	400016	31
32905	110	340040	107	352000	270	363000	264	378000	314	400018	31
32906	110	340050	107	353000	270	363100	266	379065	276	400020	31
32907	110	340060	107	354025	366	363200	269	379500	276	400024	31
32908	110	340070	107	354030	366	363201	269	380000	64	400320	31
32909	111	340080	107	354035	366	364000	264	381008	64	400324	31
32910	111	340090	107	354040	366	364100	266	381010	64	400424	31
32911	111	341000	268	354045	366	364200	269	382000	64	400524	31
32912	111	342000	268	354050	366	364201	269	38240250	189	400528	31
32913	111	343000	268	355007	387	365000	264	38250250	188	400624	30
32920	111	343400	62	355008	387	365100	266	383000	64	400628	30
330035	318	343500	62	355107	387	365200	269	384000	64	400632	30
330050	318	343600	62	355108	387	366000	265	385020	64	400635	30
330070	318	343700	62	356016	365	366100	267	385026	64	400640	30
331039	376	343800	62	356020	365	366200	269	385030	64	400724	30
331044	376	344000	268	356024	365	367000	265	385500	64	400728	30

REF.	Pag.	REF.	Pag.	REF.	Pag.	REF.	Pag.	REF.	Pag.	REF.	Pag.
400732	30	457020	103	5015	166	5250E5F1	141	611000	84	646310	340
400735	30	457024	103	5017	166	5250F1	140	611001	271	646400	340
400824	30	457028	103	5018	142	5251	138	615000	271	650000	344
400828	30	457032	103	5019	142	5251F1	140	615100	271	685004	278
400832	30	458024	103	501F1	146	5360	138	616000	318	685100	278
400835	30	458028	103	501F2	146	5360E1	139	617014	270	688010	224
400916	31	459018	103	501F3	146	5360E1F1	141	617017	270	688045	231
400918	31	459020	103	501F4	146	5360E2	139	618000	271	688085	220
400920	31	459024	103	501F5	146	5360E2F1	141	619000	325	688087	220
400924	31	459028	103	501F6	146	5360E3	139	619001	325	688150	223
400928	31	460018	106	5030	145	5360E3F1	141	619002	325	7000	176
400932	31	460020	106	5050	145	5360E4	139	619003	325	7001	176
400935	31	460022	106	5060	142	5360E4F1	141	620001	63	7002	176
400940	31	460024	106	5061	142	5360E5	139	621000	63	7002R	175
404512	105	460026	106	5062	142	5360E5F1	141	621001	63	7003	176
404514	105	460028	106	508015	231	5360F1	140	623002	342	7004	176
404516	105	460030	106	5090	138	5361	138	623003	342	7004R	175
404518	105	460032	106	5090E1	139	5361F1	140	625000	341	7005	176
404520	105	470005	105	5090E1F1	141	5490	138	630010	341	7005R	175
406524	104	480018	233	5090E2	139	5490E1	139	630020	341	7006	176
406528	104	480028	233	5090E2F1	141	5490E1F1	141	630030	341	7006R	175
407516	104	480040	233	5090E3	139	5490E2	139	630040	341	7007	176
407520	104	480118	233	5090E3F1	141	5490E2F1	141	63052	145	7008	176
407524	104	490012	101	5090E4	139	5490E3	139	63052F1	145	7009	176
407528	104	490014	101	5090E4F1	141	5490E3F1	141	632+NUM	341	7010	176
407532	104	490016	101	5090E5	139	5490E4	139	632+NUM	341	701014	380
408516	104	490018	101	5090E5F1	141	5490E4F1	141	633000	341	701016	380
408520	104	490020	101	5090F1	140	5490E5	139	633001	341	701018	380
408524	104	490220	101	5091	138	5490E5F1	141	633002	341	701020	380
408528	104	490224	101	5091F1	140	5490F1	140	633003	341	701022	380
408532	104	490616	101	5160	138	5491	138	633004	341	7011	176
409516	105	490620	101	5160E1	139	5491F1	140	634000	341	7012	176
409520	105	490624	101	5160E1F1	141	590001	263	635000	346	7013	176
409524	105	490628	101	5160E2	139	590002	263	636000	346	7014	176
409528	105	490632	101	5160E2F1	141	590003	263	637000	346	7015	176
409532	105	490716	101	5160E3	139	590004	263	637100	346	7016	176
410524	105	490720	101	5160E3F1	141	590005	263	638000	344	7017	176
411524	104	490724	101	5160E4	139	590006	263	639000	344	7018	176
411528	104	490728	101	5160E4F1	141	600005	83	640000	152	7019	176
412020	105	490732	101	5160E5	139	6001X	208	641100	152	7020	176
412024	105	490824	100	5160E5F1	141	601010	83	642000	152	702026	378
44073	145	490828	100	5160F1	140	602015	83	643000	152	702028	378
44073F1	145	5000	142	5161	138	603012	82	644100	340	7021	176
454012	103	5001	142	5161F1	140	603015	82	644175	340	7022	176
454014	103	5002	142	5250	138	604001	82	644200	340	702218	378
454016	103	5003	142	5250E1	139	604002	82	644240	340	702224	378
454018	103	5004	142	5250E1F1	141	604500	82	644275	340	702230	378
454020	103	500C1	146	5250E2	139	605000	270	646000	316	7023	176
456016	103	500C2	146	5250E2F1	141	606000	270	646100	340	7024	176
456020	103	500C3	146	5250E3	139	607000	56	646103	340	7025	176
456024	103	500C4	146	5250E3F1	141	609010	84	646105	340	7026	176
456028	103	500C5	146	5250E4	139	609200	83	646200	340	7027	176
456032	103	500C6	146	5250E4F1	141	609705	84	646300	340	7028	176
457016	103	5010	142	5250E5	139	610000	77	646301	340	7029	176

REF.	Pag.	REF.	Pag.	REF.	Pag.	REF.	Pag.	REF.	Pag.	REF.	Pag.
7030	176	7071	178	711020	379	7153	176	7196	178	7236	180
703012	379	7072	178	711024	379	7154	176	7197	178	7237	180
703016	379	7073	178	711028	379	7155	176	7198	178	7238	180
703020	379	7074	178	711032	379	7156	176	7199	178	7239	180
703024	379	7075	178	7111	180	7157	176	7200	178	7240	180
703028	379	7076	178	7112	180	7158	176	720005	381	7241	180
703032	379	7077	178	7113	180	7159	176	720006	381	7242	180
7031	176	7078	178	7114	180	7160	176	720007	381	7243	180
7032	176	7079	178	7115	180	716008	381	720008	381	7244	180
7033	176	7080	178	7116	180	716010	381	720010	381	7245	180
7034	176	708008	380	7117	180	716012	381	720012	381	7246	180
7035	176	708012	380	7118	180	7161	176	7201	178	7247	180
7036	176	708022	380	7119	180	7162	176	7202	178	7248	180
7037	176	708024	380	7120	180	7163	176	7203	178	7249	180
7038	176	708026	380	712022	380	7164	176	7204	178	7250	180
7039	176	7081	178	7121	180	7165	176	7205	178	7251	180
7040	176	7082	178	7122	180	7166	176	7206	178	7252	180
704024	378	7083	178	7123	180	7167	176	7207	178	7253	180
704030	378	7084	178	7124	180	7168	176	7208	178	7254	180
7041	176	7085	178	7125	180	7169	176	7209	178	7255	180
7042	176	7086	178	7126	180	7170	176	7210	178	7256	180
7043	176	7087	178	7127	180	717008	381	721005	381	7257	180
7044	176	7088	178	7128	180	717010	381	721006	381	7258	180
7045	176	7089	178	7129	180	717012	381	721007	381	7259	180
7046	176	7090	178	7130	180	7171	176	721008	381	7260	180
7047	178	709035	378	713075	380	7172	176	721010	381	7261	180
7048	178	7091	178	7131	180	7173	176	7211	178	7262	180
7049	178	7092	178	7132	180	7174	176	7212	178	7263	180
7050	178	7093	178	7133	180	7175	176	7213	178	7264	180
705024	55	7094	180	7134	180	7176	176	7214	178	7265	180
705028	55	7095	180	7135	180	7177	176	7215	178	7266	180
705032	55	7096	180	7136	180	7178	176	7216	178	7267	180
7051	178	7097	180	7137	180	7179	176	7217	178	7268	180
7052	178	7098	180	7138	180	7180	176	7218	178	7269	180
7053	178	7099	180	7139	180	718006	381	7219	178	7270	180
7054	178	7100	180	7140	180	718008	381	7220	178	7271	180
7055	178	710020	379	714075	381	718010	381	722000	382	7272	180
7056	178	710024	379	7141	176	718011	381	7221	178	7273	180
7057	178	710028	379	7142	176	7181	176	7222	178	7274	180
7058	178	710032	379	7143	176	7182	176	7223	178	7275	180
7059	178	7101	180	7143R	175	7183	176	7224	178	7276	180
7060	178	7102	180	7144	176	7184	176	7225	178	7277	180
706039	378	710205	232	7145	176	7185	176	7226	178	7278	180
7061	178	710206	232	7145R	175	7186	176	7227	178	7279	180
7062	178	7103	180	7146	176	7187	176	7228	178	7280	180
7063	178	7104	180	7146R	175	7188	178	7229	178	7281	180
7064	178	7105	180	7147	176	7189	178	7230	178	7282	177
7065	178	7106	180	7147R	175	7190	178	723024	379	7283	177
7066	178	7107	180	7148	176	719009	381	723028	379	7284	177
7067	178	7108	180	7149	176	7191	178	7231	178	7285	177
7068	178	7109	180	7150	176	7192	178	7232	178	7286	177
7069	178	7110	180	715006	380	7193	178	7233	178	7287	177
7070	178	711010	379	7151	176	7194	178	7234	178	7288	177
707039	378	711012	379	7152	176	7195	178	7235	180	7289	177

REF.	Pag.	REF.	Pag.	REF.	Pag.	REF.	Pag.	REF.	Pag.	REF.	Pag.
7290	177	7342	179	7394	181	7445	177	7495	179	7547	181
7291	177	7343	179	7395	181	7446	177	7496	179	7548	181
7292	177	7344	179	7396	181	7447	177	7497	179	7549	181
7293	177	7345	179	7397	181	7448	177	7498	179	7550	181
7294	177	7346	179	7398	181	7449	177	7499	179	7551	181
7295	177	7347	179	7399	181	7450	177	7500	179	7552	181
7296	177	7348	179	7400	181	7451	177	750045	382	7553	181
7297	177	7349	179	740045	382	7452	177	7501	179	7554	181
7298	177	7350	179	7401	181	7453	177	7502	179	7555	181
7299	177	7351	179	7402	181	7454	177	7503	179	7556	181
7300	177	7352	179	7403	181	7455	177	7504	179	7557	181
7301	177	7353	179	7404	181	7456	177	7505	179	7558	181
7302	177	7354	179	7405	181	7457	177	7506	179	7559	181
7303	177	7355	179	7406	181	7458	177	7507	179	7560	181
7304	177	7356	179	7407	181	7459	177	7508	179	7561	181
7305	177	7357	179	7408	181	7460	177	7509	179	7562	181
7306	177	7358	179	7409	181	746035	382	7510	179	7563	181
7307	177	7359	179	7410	181	7461	177	751060	382	7565	172
7308	177	7360	179	741035	382	7462	177	7511	179	7566	172
7309	177	736030	55	7411	181	7463	177	7512	179	7567	172
7310	177	736034	55	7412	181	7464	177	7513	179	7568	172
7311	177	7361	179	7413	181	7465	177	7514	179	7569	172
7312	177	7362	179	7414	181	7466	177	7515	179	7570	172
7313	177	7363	179	7415	181	7467	177	7516	179	7571	172
7314	177	7364	179	7416	181	7468	177	7517	181	7572	172
7315	177	7365	179	7417	181	7469	177	7518	181	7573	172
7316	177	7366	179	7418	181	7470	179	7519	181	7574	172
7317	177	7367	179	7419	181	747040	382	7520	181	7575	172
7318	177	7368	179	7420	181	7471	179	7521	181	7576	172
7319	177	7369	179	7421	181	7472	179	7522	181	7577	172
7320	177	7370	179	7422	181	7473	179	7523	181	7578	172
732000	384	7371	179	7423	177	7474	179	7524	181	7579	172
7321	177	7372	179	7424	177	7475	179	7525	181	7580	172
7322	177	7373	179	7425	177	7476	179	7526	181	7581	172
7323	177	7374	179	7426	177	7477	179	7527	181	7582	172
7324	177	7375	179	7427	177	7478	179	7528	181	7583	172
7325	177	7376	181	7428	177	7479	179	7529	181	7584	172
7326	177	7377	181	7429	177	7480	179	7530	181	7585	173
7327	177	7378	181	7430	177	748050	382	7531	181	7586	173
7328	177	7379	181	743045	382	7481	179	7532	181	7587	173
7329	179	7380	181	7431	177	7482	179	7533	181	7588	173
7330	179	7381	181	7432	177	7483	179	7534	181	7589	173
733000	384	7382	181	7433	177	7484	179	7535	181	7590	173
7331	179	7383	181	7434	177	7485	179	7536	181	7591	173
7332	179	7384	181	7435	177	7486	179	7537	181	7592	173
7333	179	7385	181	7436	177	7487	179	7538	181	7593	173
7334	179	7386	181	7437	177	7488	179	7539	181	7594	173
7335	179	7387	181	7438	177	7489	179	7540	181	7595	173
7336	179	7388	181	7439	177	7490	179	7541	181	7596	173
7337	179	7389	181	7440	177	749060	382	7542	181	7597	173
7338	179	7390	181	7441	177	7491	179	7543	181	7598	173
7339	179	7391	181	7442	177	7492	179	7544	181	7599	173
7340	179	7392	181	7443	177	7493	179	7545	181	7600	173
7341	179	7393	181	7444	177	7494	179	7546	181	7601	173

REF.	Pag.	REF.	Pag.	REF.	Pag.	REF.	Pag.	REF.	Pag.	REF.	Pag.
7602	173	769020	386	783022	385	80260	153	80811	161	815006	392
7603	175	769022	386	783024	385	80270	153	80813	161	815009	392
7604	175	770006	386	783026	385	80280	153	80814	161	815012	392
7605	175	770008	386	783028	385	80290	153	80820	167	815015	392
7606	175	770014	386	783030	385	80300	153	80821	167	815018	392
7607	175	771025	386	784020	388	803000	369	80822	167	816011	391
7608	175	777540	53	784025	388	80310	153	80840	160	816013	391
7609	175	777548	53	784030	388	80320	153	80850	160	816015	391
7610	175	777560	53	784035	388	80330	154	80860	163	817005	391
7611	175	778040	53	784040	388	80340	154	80870	160	817006	391
7612	175	778048	53	785006	385	80350	154	80880	160	817008	391
7613	175	778060	53	785008	385	80360	154	80890	162	820000	392
7614	175	779017	52	785010	385	80374	155	80891	162	821000	392
7615	175	779021	52	785012	385	80380	164	80900	152	822000	393
7616	175	779026	52	785014	385	80390	164	80910	163	823000	393
7617	175	779060	52	785016	385	804000	369	80920	167	824000	393
7618	175	780006	385	785018	385	80430	157	80922	167	825000	389
7628	174	780008	385	785020	385	80440	159	80940	155	826000	389
7629	174	780010	385	786010	386	80460	160	80941	155	830001	374
7630	174	780012	385	786012	386	80470	158	80950	163	830002	374
7631	174	780014	385	787006	387	80480	159	80951	163	830003	374
7632	174	780016	385	787008	387	80490	163	80960	154	830004	374
7633	174	780018	385	787010	387	80500	160	80961	154	830005	374
7634	174	780020	385	787014	387	805000	368	80970	158	832000	368
7635	174	780024	385	787020	387	80510	159	81000	229	833001	56
7636	174	780028	385	788025	388	80520	158	810002	391	833002	56
7637	174	781006	385	788050	388	80530	160	810004	391	833003	56
7638	174	781008	385	789025	388	80540	165	810006	391	834000	372
7639	174	781010	385	789050	388	80550	165	810008	391	835000	372
7640	174	781012	385	796000	384	80560	165	810010	391	836110	370
764004	388	781014	385	796100	384	80570	165	810012	391	836120	370
764006	388	781016	385	798040	390	80580	166	810014	391	836147	370
764008	388	781018	385	798055	390	80590	166	810016	391	836200	370
764010	388	781020	385	798065	390	806000	368	81010	229	836215	370
764012	388	782008	385	799000	384	80610	165	81020	229	837003	373
764014	388	782010	385	799100	384	80620	165	811002	391	837005	373
7641	174	782012	385	800030	390	80630	165	811004	391	837007	373
7642	174	782014	385	800035	390	80640	165	811006	391	837300	373
7643	174	782016	385	800040	390	80670	157	811008	391	839000	368
7646	173	782018	385	800045	390	80680	155	811010	391	840000	368
7647	173	782020	385	800050	390	80700	353	811012	391	841000	368
765008	386	782022	385	800055	390	807000	368	811014	391	842000	368
765010	386	782024	385	800060	390	80710	353	811016	391	843140	368
765016	386	782026	385	800065	390	80720	353	811018	391	843150	368
765018	386	782028	385	800070	390	80730	353	812003	391	843200	368
765020	386	782075	385	801040	369	80740	352	812005	391	843210	368
765022	386	783006	385	801048	369	80740	165	812007	391	845040	369
765024	386	783008	385	802000	369	80750	166	812009	391	845050	369
768006	386	783010	385	80210	150	80760	166	812011	391	845060	369
768008	386	783012	385	80216	151	80770	166	813016	391	845075	369
768016	386	783014	385	80219	150	80780	165	813020	391	845110	369
769008	386	783016	385	80220	150	80800	157	813028	391	845138	369
769010	386	783018	385	80240	153	808000	370	814000	392	845155	369
769018	386	783020	385	80250	153	80810	161	815004	392	845275	369

REF.	Pag.	REF.	Pag.	REF.	Pag.	REF.	Pag.	REF.	Pag.	REF.	Pag.
846025	82	850222	398	859120	411	859174	409	859908	402	885040	321
846050	82	850324	398	859121	411	859175	411	859909	402	885060	321
846100	82	850424	398	859122	406	859176	411	859910	402	885120	321
846200	82	850426	398	859123	406	859177	411	859911	402	886035	321
846300	82	850524	398	859124	406	859178	411	861045	352	886060	321
847008	370	850528	398	859125	407	859179	411	861053	352	886100	321
847010	370	850614	398	859126	407	859180	411	862100	343	886160	321
847012	370	850801	399	859127	407	859181	409	863000	343	887015	321
847014	370	850803	399	859128	409	859182	409	867030	308	887025	321
848008	370	850804	399	859129	409	859183	407	867060	308	887035	321
848014	370	850805	399	859130	407	859184	407	867090	308	887060	321
849000	390	851028	390	859131	405	859185	407	867120	308	887100	321
850001	396	851034	390	859132	404	859186	407	868001	74	887160	321
850002	396	851040	390	859133	404	859187	407	868002	74	888025	321
850003	396	851046	390	859134	404	859188	407	868003	74	888060	321
850004	396	851050	390	859135	404	859189	408	868004	74	890025	322
850005	396	851055	390	859136	404	859190	408	868005	74	890035	322
850006	396	851060	390	859137	404	859191	408	868006	74	890060	322
850007	396	851065	390	859138	404	859192	408	868007	74	890100	322
850008	396	853004	394	859139	404	859193	408	868008	74	890125	322
850009	396	853006	394	859140	404	859194	408	868009	74	891035	322
850010	396	853008	394	859141	404	859195	408	868100	74	891060	322
850011	396	853010	394	859142	404	859196	408	868200	74	891100	322
850012	396	853012	394	859143	405	859197	408	869005	325	891150	322
850013	396	853014	394	859144	405	859198	408	869010	325	891200	322
850014	396	853016	394	859145	405	859199	408	869019	325	892015	322
850015	396	854006	394	859146	405	859200	410	869038	325	892025	322
850016	396	854008	394	859147	405	859201	410	870000	75	892035	322
850017	396	854010	394	859148	405	859202	410	871000	75	892060	322
850018	396	854012	394	859149	405	859203	410	872000	64	892100	322
850019	396	854014	394	859150	405	859204	410	872500	370	892150	322
850020	396	854016	394	859151	405	859205	410	873045	75	892200	322
850021	397	855000	394	859152	406	859206	409	873060	75	893025	322
850022	397	856000	394	859153	406	859207	409	873090	75	893035	322
850023	397	857000	394	859154	406	859208	409	874000	343	894003	339
850024	397	859101	405	859155	406	859209	409	875003	376	894004	339
850025	397	859102	405	859156	406	859210	409	875004	376	894005	339
850026	397	859103	405	859157	406	859211	409	880020	323	894524	275
850027	397	859104	405	859158	406	859212	409	880035	323	894528	275
850028	397	859105	405	859159	406	859213	409	880050	323	894532	275
850029	397	859106	408	859160	406	859214	409	880100	323	894632	275
850030	397	859107	408	859161	406	859215	409	880175	323	895006	339
850031	397	859108	408	859162	406	859216	409	881035	323	895010	339
850032	397	859109	405	859163	406	859217	409	881050	323	895015	339
850033	397	859110	405	859164	406	859218	409	881100	323	895020	339
850034	397	859111	405	859165	406	859219	406	881175	323	896003	324
850035	397	859112	410	859166	407	859900	400	882015	323	896008	324
850036	397	859113	404	859167	407	859901	400	882035	323	896500	324
850037	397	859114	407	859168	407	859902	400	882050	323	897000	277
850038	397	859115	404	859169	407	859903	400	882100	323	897500	277
850039	397	859116	409	859170	407	859904	401	882175	323	898000	277
850040	397	859117	409	859171	407	859905	401	883035	323	899000	279
850124	398	859118	408	859172	407	859906	401	883050	323	899200	279
850128	398	859119	411	859173	407	859907	401	885025	321	899202	279

REF.	Pag.	REF.	Pag.	REF.	Pag.	REF.	Pag.	REF.	Pag.	REF.	Pag.
899300	279	904683	254	90814	151	913901	81	929030	55	951019	365
899302	279	904711	252	909111	54	914080	377	929036	55	951024	365
900000	353	904720	253	909121	54	914120	377	929040	55	952001	365
901014	81	904721	261	909211	54	914150	377	937000	78	952002	365
901018	81	904725	253	909221	54	915080	377	938000	77	952003	365
902000	271	904740	252	909340	54	915120	377	940000	76	953000	76
903001	273	904760	252	909360	54	915150	377	940090	76	953001	365
903002	273	904780	252	909460	54	916000	377	940120	76	953002	365
904100	259	904790	250	909559	375	916120	377	941000	76	953003	365
904113	257	904800	250	910008	279	917080	377	941013	61	953004	365
904113W	257	904801	261	911201	80	918000	377	941015	61	953005	365
904120	257	904804	261	911202	80	919000	354	941018	61	954013	74
904120W	257	904806	261	911301	80	920001	354	941020	61	954015	74
904140	258	904807	261	911302	80	920002	354	941022	61	954020	74
904140W	258	904809	261	911303	80	920003	354	941024	61	954025	74
904142	260	904810	253	911304	80	921001	354	941028	61	955010	61
904145	258	904820	253	911305	80	922000	354	942000	75	955012	61
904145W	258	904850	253	911306	80	922100	354	943000	75	955015	61
904146	260	904890	253	911401	80	923000	354	944000	76	955017	61
904150	256	90490	148	911402	80	923001	354	94500250	191	955020	61
904150W	256	90492	148	911403	80	924001	355	945037	71	956035	325
904151	260	90492	149	911404	80	924002	355	945050	71	956040	325
904155	256	90493	148	911405	80	924002A	355	945051	71	956135	325
904157	256	90493	149	911406	80	924002R	355	946001	74	956140	325
904160	258	904937	255	911501	81	924002V	355	946002	74	958010	72
904160W	258	90495	149	911502	81	925001	355	946003	74	958012	72
904165	257	904950	255	911503	81	925001	164	946004	74	958014	72
904165W	257	904975	255	911504	81	925002	355	947033	86	958016	72
904200	259	904980	255	911505	81	925002	164	947038	86	958018	72
904300	259	904990	255	911506	81	926001	329	947043	86	959025	366
904350	245	905015	75	911601	81	926002	329	947101	86	959030	366
904351	245	905200	249	911602	81	926003	329	947102	86	959035	366
904352	245	905300	248	911603	81	926004	329	947103	86	959040	366
904360	245	905310	248	911604	81	926005	329	947201	86	959045	366
904361	245	905320	249	911605	81	926006	329	947202	86	959050	366
904370	245	905340	249	911606	81	926007	329	947203	86	960225	367
904371	245	905400	247	911701	80	926008	329	947301	86	960230	367
904400	259	905410	248	911801	80	926009	329	947302	86	960235	367
904500	259	905504	246	911802	80	926010	329	947303	86	962002	232
904600	254	905506	246	911803	80	926011	329	947400	87	962003	232
904601	254	905508	247	911804	80	926012	329	947500	87	963025	55
904610	254	905516	246	911805	80	926051	328	947600	87	963030	55
904611	254	905518	247	911806	80	926052	328	947700	87	963035	55
904612	254	906024	315	911901	81	926053	328	948066	56	963040	55
904613	254	906100	284	911902	81	926101	329	948090	56	964000	78
904650	254	906150	284	911903	81	926102	329	948132	56	967001	342
904651	254	907024	272	911904	81	926103	329	948163	56	967002	342
904652	254	907026	272	911905	81	926104	329	949025	55	967003	342
904653	254	908000	376	911906	81	926105	329	949030	55	967004	342
904660	254	908001	376	912001	80	927000	273	949035	55	967005	342
904661	254	908002	376	913000	81	928000	273	949040	55	967006	342
904680	254	908003	376	913501	81	928001	273	950000	278	968000	343
904681	254	908004	376	913601	81	929025	55	951010	365	968115	343
904682	254	90813	151	913701	81	929028	55	951015	365	968125	343

REF.	Pag.	REF.	Pag.	REF.	Pag.	REF.	Pag.
968130	343	994022	48	JX40CE	209	WFP16SCDE	193
968135	343	994024	48	MMB145CE	202	WFP16SE	193
969000	342	994026	48	MMB150CE	202	WFP7E	195
969132	342	994030	48	MMB160CE	202	WKS800E	209
969136	342	994032	48	MX1000XTPEE	205	WPG150E	219
969140	342	994034	48	MX1000XTXEE	205	WPG250E	219
970000	374	994036	48	MX1100XTPSEE	205	WSB01	198
970000	70	994038	48	MX1100XTXSEE	205	WSB2W	198
972060	56	994040	48	MX1200XTXEE	206	WSB33XE	198
974000	315	994042	48	MX1500XTPSEE	205	WSB40E	198
975000	77	994046	48	MX1500XTXSEE	205	WSB50E	197
975100	77	994050	48	RE150951	192	WSB50ST	197
975500	73	994055	48	RE1509510	192	WSB55E	197
975600	73	994065	48	RE1509511	192	WSB55ST	197
975900	73	994080	48	RE150952	192	WSB60E	197
976200	315	994090	48	RE150953	192	WSB60ST	197
976300	315	995010	48	RE150954	192	WSB65E	197
977015	56	995016	48	RE150955	192	WSB65ST	197
979000	372	995020	48	RE150956	192	WSB70E	197
979100	372	995026	48	RE150957	192	WSB70ST	197
979200	372	995030	48	RE150958	192	WSBBC	197
980000	84	995034	48	RE150959	192	WSBPPCE	197
980050	84	995036	48	RE937001	78	WSBPPWE	198
980200	84	995038	48	RE937002	78	WSG30E	210
980400	85	995040	48	RE937003	78	WSG60E	210
981400	85	995042	48	RE940001	76	WW180E	227
981500	85	995050	48	RE941001	76	WW200E	227
981600	85	995060	48	RE964100	78	WWCM180E	227
981650	85	997014	48	RE964200	78		
983000	319	997016	48	RE975001	77		
984000	319	997028	48	RE975002	77		
984100	319	997032	48	RE975101	77		
984150	319	997036	48	RE975102	77		
984500	319	997040	48	RE975901	73		
985000	319	998035	49	SC80957	163		
986000	319	998050	49	SE1000	206		
986100	319	998070	49	SE500	206		
987100	319	999000	49	WCG75E	195		
987200	319	BB180PE	200	WCO500TR	223		
988000	316	BB185PE	200	WCO500XE	223		
988100	316	BB25EP	203	WCT708E	216		
988200	316	BB25ES	203	WDM120E	208		
988300	316	BJX240	209	WDM240E	208		
989000	316	CAC29	203	WDM360E	208		
990000	316	CAC31	200	WFP14S1	194		
9900000	191	CAC37	203	WFP14S10	194		
991010	372	CAC87	200	WFP14S11	194		
991108	372	CAC90I	206	WFP14S12	194		
991112	372	CAC93XI	206	WFP14SCE	194		
992035	387	CAC95I	206	WFP14SE	194		
992040	387	CB15VE	203	WFP16S1	193		
992045	387	CTS1000E	214	WFP16S10	193		
992050	387	HGB25E	200	WFP16S11	193		
994020	48	IC70E	210	WFP16S12	193		

CONDICIONES GENERALES DE VENTA / GENERAL SELLING CONDITIONS / CONDITIONS GENERALES DE VENTE / GENERELLE VERKAUFSBEDINGUNGEN

ESPAÑOL

CONDICIONES DE VENTA

RESERVA DE DOMINIO

PUJADAS se reserva el derecho de propiedad de todos los materiales suministrados hasta el cumplimiento íntegro del pago de los mismos.

PRECIOS

Los precios de venta son los que figuran en nuestras tarifas y se refieren para la mercancía situada en nuestros almacenes de Santa Coloma de Farners con embalaje de cartón no retornable.

PORTES

Todos los pedidos de ámbito Península y Baleares con un valor superior a 300 €. (600 €. Canarias), Se enviarán a portes pagados. Resto de países a consultar.
Pedidos de importe inferior podrán viajar con porte a cargo de PUJADAS mediante recargo del 4% en factura del valor neto del pedido con un mínimo de 10 €.

CANTIDADES

Los materiales serán suministrados por embalajes completos conteniendo las cantidades indicadas en nuestras tarifas.

DEVOLUCIONES

Sólo se admitirán las devoluciones aceptadas previamente por PUJADAS, en embalajes completos, etiquetados y referenciados. Para la aceptación de la misma será necesario remitir el formulario PUJADAS de devolución, firmado por el comercial de PUJADAS asignado y autorizado por Dirección Comercial. En caso de devolución por error en el pedido, o por razones ajenas a PUJADAS, la mercancía y el embalaje de la misma deberán encontrarse en condiciones para su reventa y estar referenciada en la tarifa vigente. La mercancía será abonada a su valor neto cargándose un demérito del 10% en concepto de participación en los costes de revisión y manipulación, descontándose si ha lugar el coste del embalaje y su acondicionamiento. En ningún caso se admitirán devoluciones de materiales que hayan sido utilizados.
Tampoco se admitirá la devolución de aquellos materiales en los que PUJADAS haya realizado alguna adaptación específica para el pedido. Las devoluciones o envíos de materiales a las instalaciones de PUJADAS ya sea para su abono, sustitución o reparación deberán efectuarse siempre a portes pagados.
Las devoluciones de ESTANTERIAS se efectuarán sólo en embalajes completos, sobre palet si es más de un embalaje y con protección de film plástico sobre el mismo.
Las devoluciones de CARROS se harán sobre palet y con embalaje protector completo.

RECLAMACIONES

En ningún caso se aceptarán reclamaciones sobre el estado de la mercancía o sobre errores de envíos una vez pasados 15 días laborales desde su recepción.

REPARACIONES

La reparación o reposición de materiales defectuosos se realizará sin cargo sólo cuando esté dentro del periodo de garantía. Nuestros productos están garantizados por el plazo de dos años (un año en el caso de la maquinaria). En todos los casos en que resulte exigible la garantía nuestra responsabilidad se limita a la entrega gratuita de un nuevo producto que sustituya al averiado o al reembolso íntegro del precio del producto afectado, quedando expresamente excluida cualquier responsabilidad por daños y perjuicios o cualesquiera otros gastos, cargos o indemnizaciones.

FOTOS, DATOS Y MEDIDAS

Las fotos, datos y medidas de este catálogo pueden cambiar, sin previo aviso por exigencias técnicas o de producción.

LEY APLICABLE Y JURISDICCIÓN COMPETENTE

Las partes de estas Condiciones Generales de Venta acuerdan expresamente que cualquier litigio en relación con las mismas sea sometida a la jurisdicción de los tribunales de Barcelona (España) y que la Ley aplicable sea la Ley española.

ENGLISH

GENERAL SELLING CONDITIONS

TITLE RETENTION

PUJADAS reserves ownership rights over all the materials supplied until full payment of the same.

PRICES

The selling prices are those specified in our rates, in reference to the merchandise in our warehouse of Santa Coloma de Farners with non-returnable cardboard packaging.

FREIGHT

All orders made from the area of the Peninsula and the Balearic Islands with a value over 300 € (600 € in Canary Islands), shall be shipped prepaid. The remaining countries should consult regarding the same.
Orders with a lower value may be shipped with freight collect chargeable to PUJADAS for a surcharge of 4% over the net worth of the invoice on a minimum order of 10 €.

QUANTITY

The materials will be supplied in complete packaging containing the quantity indicated in our rates.

RETURNS

PUJADAS shall only admit returns which it has previously accepted, in complete packaging, labelled and indexed. In order to accept the same it will be necessary to remit the PUJADAS return form, signed by the salesperson of PUJADAS, settled and authorized by Business Management. In case of return due to mistake in the order, or due to reasons not attributable to PUJADAS, the merchandise and the packaging thereof should be in conditions for resale and be indexed at the rate in force. The merchandise shall be paid at its net worth, charging a depreciation of 10% for sharing in costs of inspection and handling, discounting, as the case may be, the cost of packaging and the condition thereof.
Under no circumstances shall the return of materials which have been used be admitted.
Neither shall the return of materials be admitted in which PUJADAS has performed some specific adaptation to comply with the order.
The returns or shipments of materials to the facilities of PUJADAS whether for payment, replacement or repair should always be made by prepaid freight. The return of SHELVING shall only be performed in complete packaging, on pallets if it is more than one packaging and with plastic film protection over the same.
The return of TROLLEYS shall be made on pallets and with complete protective packaging.

CLAIMS

Under no circumstances shall claims concerning the condition of the merchandise or regarding shipping mistakes be accepted once 15 workdays have elapsed since the reception thereof.

REPAIRS

The repair or replacement of defective materials shall be performed without charge only when it is within the warranty period. Our products are guaranteed for a two year term (one year for machinery).
In all cases in which the warranty turns out to be enforceable, our liability is limited to the free delivery of a new product in substitution for the damaged product or full reimbursement of the price of the affected product, expressly excluding hereby any liability for consequential damages or any other expenses, charges or indemnities.

PHOTOS, DATA AND MEASUREMENTS.

The photos, data and measurements in this catalogue are subject to change, without prior notice, due to technical or production requirements.

GOVERNING LAW AND JURISDICTION

The parties to these General Selling Conditions agree that they shall be governed and interpreted according to the laws of Spain and both parties hereby expressly submit to the jurisdiction of the Courts of Barcelona (Spain), in respect of any proceedings arising out of or in connection with the present General Selling Conditions.

CONDICIONES GENERALES DE VENTA / GENERAL SELLING CONDITIONS / CONDITIONS GENERALES DE VENTE / GENERELLE VERKAUFSBEDINGUNGEN

FRANÇAIS

CONDITIONS GENERALES DE VENTE

RÉSERVE DE PROPRIÉTÉ

PUJADAS se réserve le droit de propriété sur toutes les marchandises fournies jusqu'au paiement total de celles-ci.

PRIX

Les prix de vente sont ceux qui figurent sur nos tarifs et font référence à la marchandise se trouvant dans nos entrepôts de Santa Coloma de Farners sous emballage en carton non retournable.

PORTS

Toutes les commandes sur la Péninsule et les Baléares d'une valeur supérieure à 300 € (600 € pour les Canaries) seront envoyées en port payé. Pour les autres pays, veuillez consulter. Les commandes inférieures pourront être expédiées avec port à la charge de PUJADAS moyennant une majoration sur facture de 4% de la valeur nette de la commande et pour un minimum de 10 €.

QUANTITÉS

Les marchandises seront fournies par emballages complets contenant les quantités indiquées sur nos tarifs.

RETOURS

Seuls seront admis les retours préalablement acceptés par PUJADAS, dans des emballages complets, étiquetés et référencés. Pour l'acceptation de ces derniers, il faudra remettre le formulaire PUJADAS de retour, signé par le commercial de PUJADAS assigné et autorisé par la Direction Commerciale. En cas de retour pour erreur sur la commande ou pour des raisons indépendantes de la volonté de PUJADAS, la marchandise avec son emballage devront être en condition de revente et elle devra être référencée sur le tarif en vigueur. La marchandise sera créditée à concurrence de sa valeur nette en appliquant une dépréciation de 10% à titre de frais de révision et de manutention et en décomptant s'il y a lieu le coût de l'emballage et de son conditionnement.

Les retours de marchandises ayant été utilisées ne seront en aucun cas acceptés.

Le retour de marchandises sur lesquelles PUJADAS aura réalisé une quelconque adaptation spécifique à la commande ne sera pas non plus accepté.

Les retours ou envois de marchandises aux installations de PUJADAS, que ce soit pour être créditées, remplacées ou réparées, devront être toujours effectués en port payé.

Les retours d'ÉTAGÈRES ne seront effectués que sous emballages complets, sur palette s'il y a plus d'un emballage, et protégés à l'aide d'un film plastique tout autour.

Les retours de CHARIOTS seront effectués sur palette et sous emballage protecteur complet.

RÉCLAMATIONS

Les réclamations sur l'état de la marchandise ou pour erreur d'envoi ne seront en aucun acceptées après écoulement d'un délai de 15 jours ouvrables à compter de la date de réception.

RÉPARATIONS

La réparation ou le remplacement de marchandises défectueuses seront effectués sans frais dès l'instant que la période de garantie sera en vigueur. Nos produits sont garantis pendant une période de deux ans (un an pour les machines).

Dans tous les cas où la garantie sera exigible, notre responsabilité se limitera à la livraison gratuite d'un nouveau produit remplaçant le produit défectueux ou au remboursement du produit affecté, toute autre responsabilité en dommages-intérêts ou tout autre frais, débit ou indemnisation étant expressément exclus.

PHOTOGRAPHIES, DONNÉES ET DIMENSIONS

Les photos, données et dimensions de ce catalogue peuvent changer sans préavis suite à des impératifs techniques ou de production.

JURIDICTION COMPÉTENTE ET LOI APPLICABLE

Pour le règlement des litiges, les deux parties s'en remettent expressément aux Tribunaux de Barcelone (Espagne), comme juridiction compétente étant la Loi applicable la Loi Espagnole.

DEUTSCH

VERKAUFSBEDINGUNGEN

Eigentumsrecht

PUJADAS behält sich das Eigentumsrecht an allen gelieferten Materialien bis zur vollständigen Bezahlung derselbigen.

PREISE

Die Verkaufspreise sind in unseren Tarifen festgeschrieben und beziehen sich auf die Ware in unserem Lager in Santa Coloma de Farners mit Kartonverpackung nicht rücksendbar.

LIEFERUNG

Alle Bestellungen auf der Halbinsel Spanien und den Balearen mit einem Wert über 300 € (600 € Kanarische Inseln) werden bei Vorauszahlung Frachtkostenfrei geliefert. Bei Lieferungen in andere Ländern fragen Sie bitte nach. Bestellungen unterhalb des Wertes können auf Kosten von PUJADAS geliefert werden mit einem Preisaufschlag von 4% des Nettobestellwertes bei einem Mindestbestellwert von 10 €.

MENGEN

Die Produkte werden in kompletten Verpackungen geliefert, welche die in unseren Tarifen angegebenen Mengen beinhalten.

RÜCKGABE

Rücksendungen, in kompletten Verpackungen, etikettiert mit Referenznummern, werden nur angenommen, wenn PUJADAS diese vorher akzeptiert hat. Für die Akzeptierung ist es nötig das Rückgabeformular von PUJADAS zu schicken, welches vom zugeteilten PUJADAS Vertreter unterschrieben sein soll und durch die Verkaufsleitung autorisiert.

In Fall der Rückgabe wegen Falschbestellung oder aus nicht von Pujadas zu vertretenen Gründen, muss die Ware und die Verpackung in einem wiederverkäuflichen Zustand sein und in den aktuellen Tarifen aufgelistet sein. Die Ware wird in seinem Nettowert erstattet mit einer Reduzierung von 10% an Bearbeitungs- und Kontrollkosten, in manchen Fällen können die Verpackungs- und Bereitstellungskosten auch abgezogen werden. In keinem Fall wird die Rückgabe von Materialien zugelassen, die schon gebraucht wurden. Es wird auch keine Rückgabe von Materialien zugelassen, die von PUJADAS teilweise speziell für die Bestellung angefertigt wurden. Die Frachtkosten für die Rückgabe oder Rücksendung der Materialien zu den Einrichtungen von PUJADAS, sei es wegen seiner Gutschrift, Ersetzung oder Reparatur müssen immer bezahlt sein. Die Rückgabe der Regale werden nur mit seiner kompletten Verpackung akzeptiert. Sind es mehr Verpackungen, müssen diese auf einer Palette mit einer Verpackungsfolie zusammen verpackt sein. Die Rückgabe der Wägen hat auf einer Palette mit der kompletten Schutzhülle zu erfolgen.

REKLAMATIONEN

Auf keinen Fall werden Reklamationen wegen dem Zustand der Waren oder Falschlieferungen 15 Werktagen nach Erhalt der Waren akzeptiert.

REPARIERUNGEN

Die Reparatur oder Ersetzung von defekten Waren erfolgt nur innerhalb des Garantiezeitraums ohne Kosten. Die Garantiedauer unserer Produkte beträgt zwei Jahre (1 Jahr im Falle von Maschinen).

In allen Garantiefällen, beschränkt sich unsere Verantwortung auf die kostenlose Lieferung eines neuen Produktes, welches das Defekte ersetzt oder auf die Zurückerstattung des Wertes des betroffenen Produktes. Die Haftung für Schäden, Folgeschäden oder irgendwelche andere Kosten, Gebühren oder Wiedergutmachungen ist ausdrücklich ausgeschlossen.

FOTOS, DATEN UND GRÖSSEN

Fotos, Daten und Grössen im Katalog können sich ohne vorherige Ankündigung aus technischen Gründen oder aus Produktionsanforderungen ändern.

ANWENDBARES RECHT UND ZUSTÄNDIGER GERICHTSSTAND

Die Parteien dieser generellen Verkaufsbedingungen erklären sich ausdrücklich damit einverstanden, dass im Streitfall, der zuständige Gerichtsstand in Barcelona [Spanien] sein wird und das anzuwendende Recht, das spanische Recht ist.

pujadas[®]

A VOLLRATH[®] COMPANY

PROFESSIONAL COOKWARE

CARRETERA DE CASTANYET 132 P.O.BOX 121
17430 SANTA COLOMA DE FARNERS (GIRONA) SPAIN
TEL. +34 972 843 201 - FAX. +34 972 843 527
INFO@PUJADAS.ES - WWW.PUJADAS.ES