

RICAMBI - SPARE PARTS

REV. 00
 del 01/06/12

MI52



MI52

Codice / Code

			MI52
			Codice / Code
1	Piano di carico inferiore vedi TAV-A4	Lower conveyor see TAV-A4	D01317
2	Volantino guida pane	Knob duct bread	C00527
3	Misura altezza	Height upper conveyor	C00044
4	Spingipane ultimo pezzo	Bread-pusher last bread	D01339
6	Carter superiore	Upper cover	D01295
7	Spalla dx	Right shoulder	D01280
7	Spalla sx	Left shoulder	D01278
8	Pannello frontale	Front cover	D01343
10	Piano d'uscita inox	Exit table	D01298
11	Cassette raccogli briciole	Drawer for crumbs	C00186
12	Ruote con freno	Wheels with brake	C00442
12	Ruote senza freno	Wheels without brake	C00443
13	Guide uscita pane Dx	Bread exit duct right	D01365
13	Guide uscita pane Sx	Bread exit duct left	D01366

QUADRO COMANDI – BUTTON PANEL



1	Pulsante salita tappeto superiore	Upper belt up button	S00355
2	Pulsante discesa tappeto superiore	Upper belt down button	S00355
3	Pulsante di marcia	Start button	S00454
4	Pulsante di emergenza	Emergency stop button	S00055
5	Pulsante di stop	Stop button	S00356
6	Spia tensione in linea	Tension in line	S00455
7	Potenziometro velocità completo	Speed potentiometer	S00052

GRUPPO GUIDAPANE – BREAD DRIVING GROUP



1	Volantino manovra art. 198-150	Knob art. 198-150	C00527
2	Riga regolatore larghezza Dx	Regulator with rod right	D01308
2	Riga regolatore larghezza Sx	Regulator with rod left	D01309
3	Bussole nylon	Spacer bushing nylon	D01314
4	Distanziali nylon	Spacer nylon	D01315
6	Chiocciola bronzo Dx	Bronze screw nut right	D01312
6	Chiocciola bronzo Sx	Bronze screw nut left	D01313
7	Distanziale L=67	Spacer L=67	D01316
8	Barra filettata	Bar	D01310
9	Tappeto convogliatore superiore	Upper conveyor belt	S00279
10	Tappeto convogliatore inferiore	Lower belt conveyor	S00282

CONVOGLIATORE INFERIORE-LOWER CONVEYOR

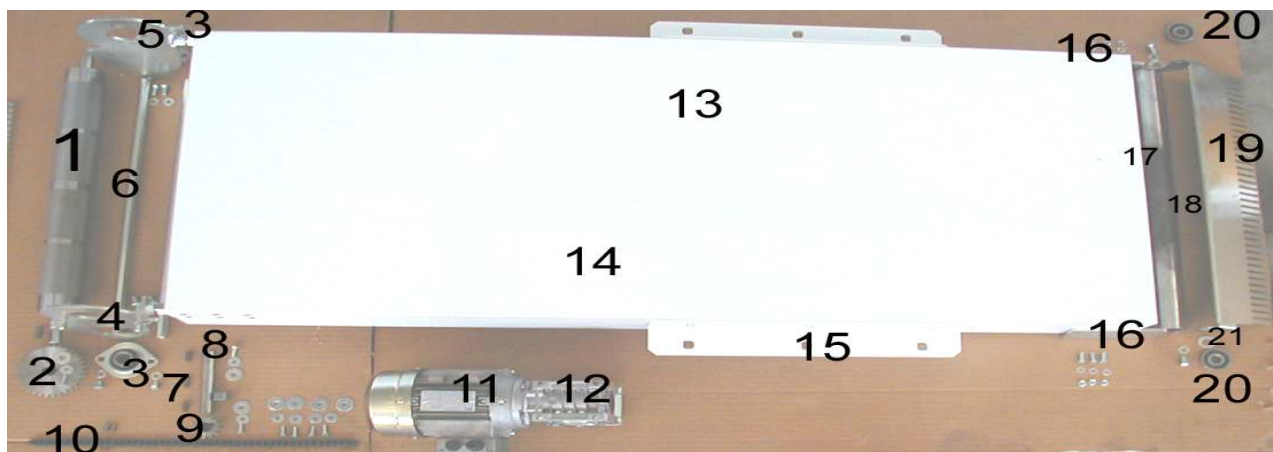

1	Cilindro traina tappeto	Cylinders for belt towing	D01414
2	Ingranaggio Z	Gear	D01413

3	Supporto USBL	USBL support	C00460
4	Piastra attacco riduttore	Plate reducer	D01407
5	Attacco riduttore senza foro	Reducer support	D01417
6	Distanziale	spacer	D01416
7	Chiavette 25x6x6	Small keys	V00072
8	Albero riduttore	Shaft reducer	D01412
8	Bussola distanziale	bushing spacer	D01415
9	Ingranaggio Z13	Gear	D01411
10	Catena semplice	Chain	C00557
11	Motore	Motor	C00594
11	Motoriduttore morsettiera 2	Motor reducer 2	C00313
11	Motoriduttore morsettiera 4	Moto reducer 4	C00314
12	Riduttore	Reducer	C00402
13	Tappeto 2980x514	Belt	S00282
14	Piano lavoro entrata	conveyor work table	D01317
14	Sottopiano	undertable	D01320
15	Supporti piano	Table support	D01329
16	Piastra supporto cilindro fisso dx e sx	Plate support cylinder dx/sx	C00292
17	rullo tenditappeto	Belt tension roller	D01335
18	Albero rullo tenditappeto	Shaft belt tension	D01334
19	Scivolo dentate posteriore (vari passi)	Lower comb	
20	Cuscinetto	bearing	C00184
21	Rondella teflon	Teflon spacer	C00430

CONVOGLIATORE SUPERIORE-UPPER CONVEYOR

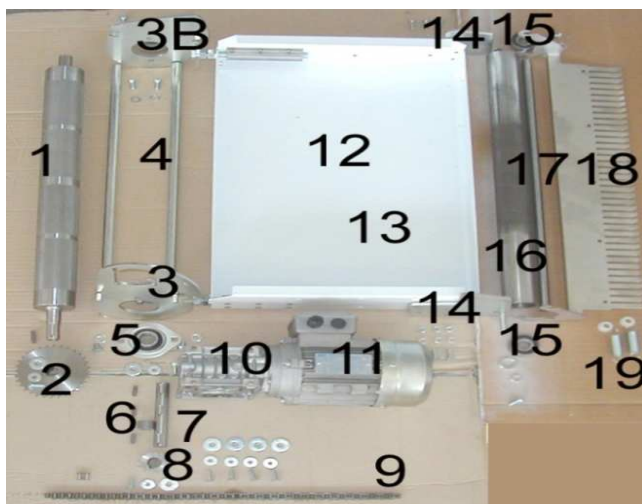

MI 52



1	Cilindro traina tappeto	Cylinders for belt towing	D01414
2	Ingranaggio Z	gear	D01413
3	Piastra attacco riduttore	Plate reducer	D01409
3B	Attacco riduttore senza foro	Reducer support	D01410
4	Distanziali	Spacers	D01416
5	Supporto USBL	USBL support	C00460
6	Chiavette	Small keys	V00072
7	Albero riduttore	Shaft reducer	D01412
8	bussola distanziale	bushing spacer	D01415
8	Ingranaggio Z13	Gear	D01411
9	Catena	Chain	C00557
11	Motore	Motor	C00594
11	Motoriduttore morsettiera 2	Motor reducer 2	C00313
11	Motoriduttore morsettiera 4	Moto reducer 4	C00314

12	Riduttore	Reducer	C00402
12	Tappeto mobile 1195 x 514	Belt	S00279
13	Piano convogliatore	Conveyor table	D01323
13	Sottopiano	undertable	D01325
14	Piastra supporto cilindro fisso	Plate support cylinder dx/sx	C00292
15	Cuscinetto	Bearing	C00184
16	Rullo tenditappeto	Belt tension roller	D01335
17	Albero rullo tenditappeto	Shaft belt tension	D01334
18	Premipane superiore (vari passi)	Bread presser	
18/a	Premipane superiore fisso	Bread presser (not tilting type)	

GRUPPO TELAIO – FRAME GROUP

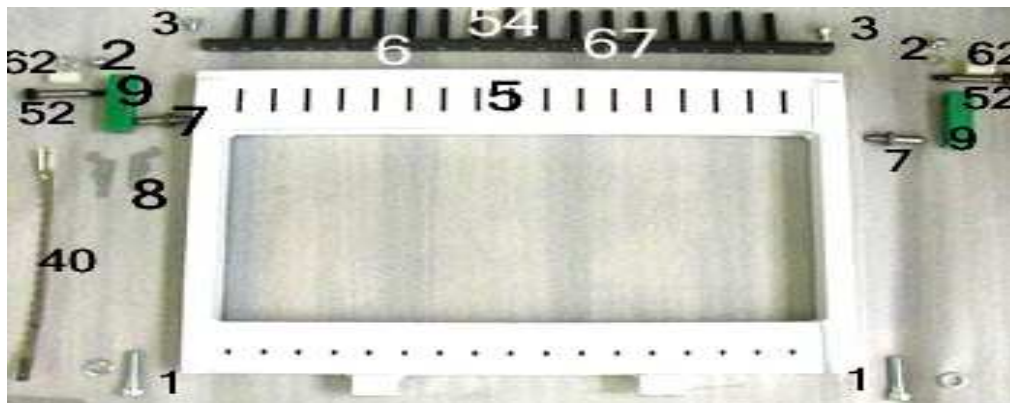

1	Viti fissaggio telaio	Screw fixing frame	V00136
2	Dado cieco M8	Nut M8	V00002
3	Viti fissaggio piatto grani tendilama	Screw fixing dowel blades	V00081
5	Telaio portalame (a passo)	Frame	
6	Piatto per grani tendilama (a passo)	Plate for dowel blades	
7	Perno superiore telaio portalame	Frame upper pin	D00614
8	Leva-martelletto tiralama dx	Blade tension lever right	D00616
8	Leva-martelletto tiralama sx	Blade tension lever left	D00617
9	Biella guida telai	Connecting rod	D01431
40+65	Lama con perno	Blade with pin	P00488
52	Vite rettificata M8 10x55	Screw M8 10x55	C00047
54	Grani stei 12,9 PP 8x50 5923	Dowels stei 12,9 PP 8x50 5923	V00137
62	Distanziale Miniplast mp 05-6-10-15-20 (0,2391)	Spacer miniplast	C00202
67	Dado M8 x fissaggio grani	Nut M8 fixing dowels	C00197

SUPPORTO TELAI – FRAME SUPPORT

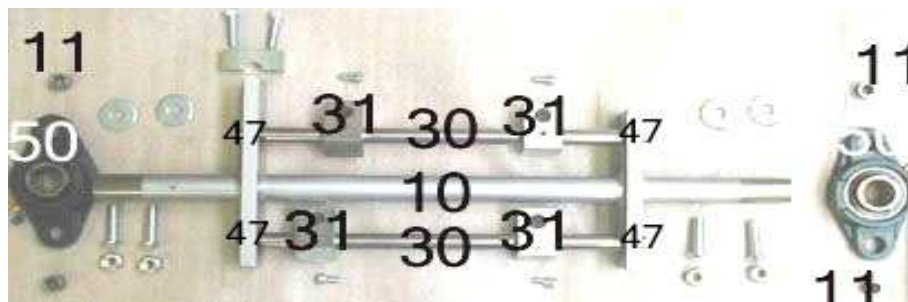

10	Albero movimento telaio	Shaft	D01345
11	Bussole per viti supporto	Spacers	D00623
30	Aste supporto portatelaio	Supporting rod	D00837

31	Blocchetti attacco albero portatelai	Supports frame shaft	D00652
50	Supporto UCFL 205 D=25	Support UCFL 205 D=25	C00463
47	Cuscinetto 6202	bearing	C00174

GRUPPO TRASMISSIONE – DRIVING GROUP

TAV- A8

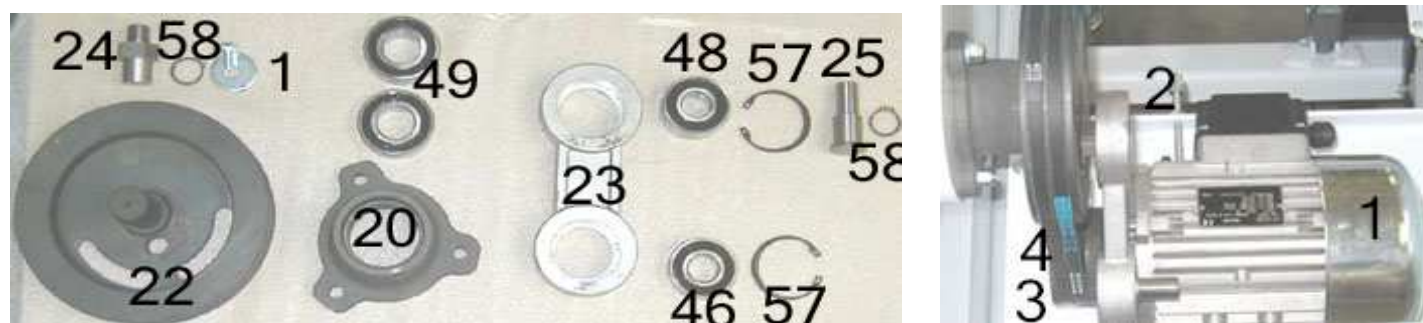

22-58	GRUPPO TRASMISSIONE COMPLETO	COMPLET TRANSMISSION SET	G00305
1	Vite TE M8X16	Screw	V00096
20	Supporto puleggia condotta	Pulley support	D00639
22	Puleggia condotta	Pulley	D00641
23	Biella puleggia condotta	Connecting rod pulley	D00642
24	Perno puleggia condotta + seeger	Pin pulley + seeger	D00643
25	Perno biella	Pin connecting rod	D00644
46	Cuscinetto orientabile uni 2204 E2RS120	Adjustable bearing 2204	C00164
48	Cuscinetto 6204-2RS1 20/47/14	Bearing 6204	C00175
49	n. 2 Cuscinetti 6205-2RS 25/52/15	n. 2 bearing 6205	C00176
57	Seeger per foro D=10 uni 7435	Seeger for hole D=10	C00002
58	Anello Seeger x albero D=20 uni 7435	Seeger x shaft D=20	C00003
1	Motore tav A9	Motor TAV- A9	C00338
2	Supporto motore e tendimotore TAV-A9	Motor support and tightening	D00700
3	Puleggia motore TAV-A9	Pulley	D01349
4	Cinghie trasmissione TAV –A9	chains	C00150

SUPPORTO TAPPETO SUPERIORE-UPPER CONVEYOR SUPPORT

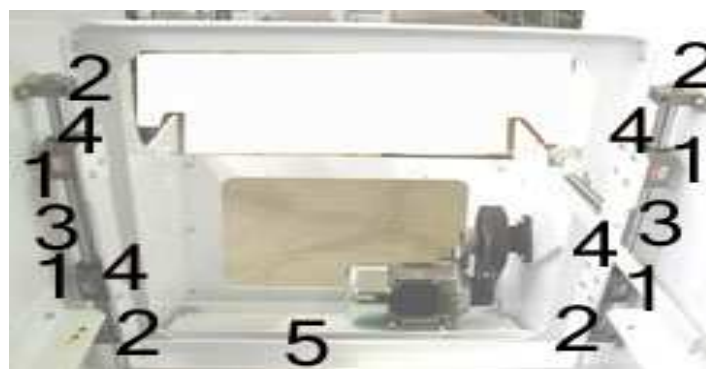

1	Manicotti a sfere	Muff with spheres	D00641
2	Supporto di estremità INA GW20	support	C00458
3	Barra di scorrimento	bar	D01306
4	Lamierino di spessoramento	plate	D01305
5	Telaio supporto nastro superiore	Upper conveyor support	D01304

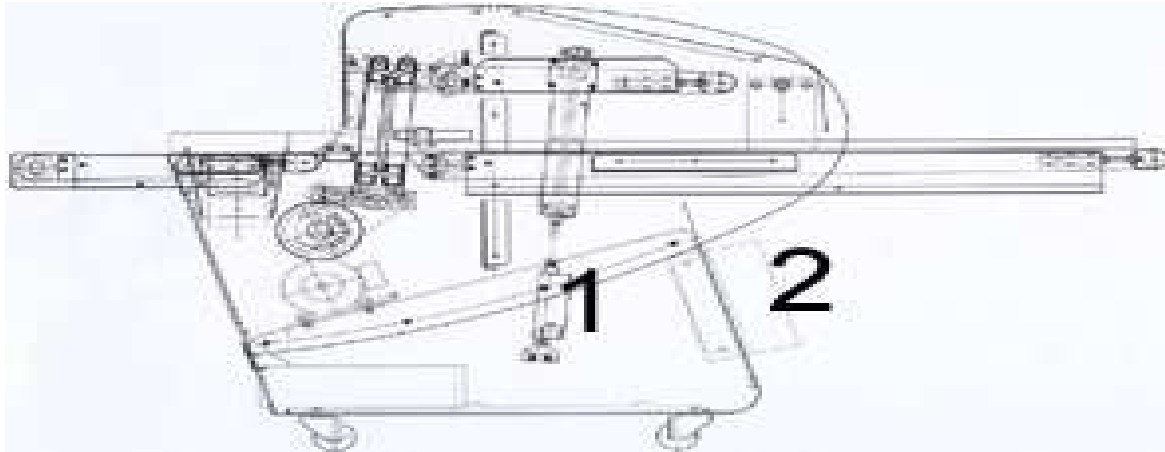

1

Attuatore a0-1/M V24 C102 S16 M2

Linear motor actuator

S00001