

# Product Catalogue

Food Preparation

Food Preparation



# Safety comes first

## BPA free

Your health is important to us, always. All plastic components in contact with food are BPA free. The absence of this chemical contribute to render the product safe for your health.



Let us ride with you

Are you looking for the user manual or do you need other support materials?

E-Tandem\*, the Electrolux Professional Digital Service will help you get immediate access to numerous tools.

Simply scan the QR code on the machine and start your ride.

\*on selected models. Look for the Tandem.

# The range



**Combined cutter/slicers**

---

Page 4



**Vegetable slicers**

---

Page 14



**Food processors**

---

Page 22



**Portable/Turbo mixers**

---

Page 28



**Planetary mixers**

---

Page 34



**Vegetable peelers**

---

Page 44



**Vegetable washers/dryers**

---

Page 48



**Complementary products**

---

Page 50

# TrinityPro Combi Cutter-Slicers

The heart and soul of vegetable preparation. A cutter and slicer all in one, the ideal solution to keep up with the latest culinary trends, even in the smallest kitchens.



Micro-toothed blade rotor  
(included)

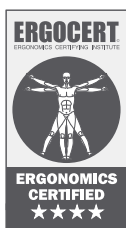

## Certified ergonomics

ErgoCert 4-star certification for ergonomic design and ease of use.

## Maximum power, minimal space

**Small but does it all.** Powerful motor for higher productivity in a reliable compact solution.

## Limitless creativity

**3 options in 1.** Tailor your menu as desired. Simply change from a vegetable slicer to a cutter mixer/emulsifier **in a matter of seconds**, with a choice of up to 22 different cutting options.

## Absolute precision

**Exceptional quality** in slicing, dicing and blending. **Optimal results** thanks to **smart speed control** that recognizes the processor head and adjusts the speed accordingly.

## A match beyond compare

**Amaze customers with the most unique creations**, combining **perfectly sliced vegetables** with the **smoothest creams**.

## Design and experience combined

**Over 75 years** experience in designing high performing solutions for food preparation.





### Optimize production

**Maximum load capacity** thanks to unique hopper design able to hold 1,25 liters.



### Outstanding results

Capture the essence of **superior emulsifying**. Prepare the smoothest creams and sauces, a taste customers will come back for.



### Fast operations

**Save money and reduce work hours** by eliminating manual dicing even for **long vegetables** thanks to small feed chutes (Ø 25mm and 55mm).



### Quality and safety

**Consistent quality results** with the integrated scraper for continuous scraping during processing and the addition of liquids through the central opening, **avoiding** the risk of **food contamination**.



### Zero waste

**Optimal performance** of ejector ensures **less waste**. Very little remains in cutting chamber.



### Simply effortless

**Easy to use, move and store without difficulty**. A compact plug-in solution with an intuitive touch control that occupies minimal space. Motor base footprint 23x32cm.

#### Cutter slicers 2,6 lt bowl

Speed	Phases	Power	RPM
1 speed	1 ph	500 W	1500
Variable	1 ph	750 W	500-3600
External Dimensions (mm) WxDxH: 348x328x527			

#### Cutter slicers 3,6 lt bowl

Speed	Phases	Power	RPM
1 speed	1 ph	500 W	1500
Variable	1 ph	750 W	500-3600
External Dimensions (mm) WxDxH: 348x334x527			



# Express your creativity

Slice, dice, grate, shred, mix, chop and emulsify with a wide variety of optional accessories.

## For Vegetable Slicers\*

<p><b>Slicers</b> 1mm to 6mm In alum.: 8mm and 10mm</p>	<p><b>Wavy Slicers</b> 3mm, 5mm</p>	<p><b>Shredders</b> 2mm, 4mm, 8mm</p>
		
<p><b>Graters</b> 2mm to 4mm, 7mm</p>	<p><b>Parmesan</b></p>	<p><b>Dicing Grids</b> 8x8mm, 10x10mm</p>
		
<p><b>Dicing Kit (grid + slicer)</b> 8x8x8mm, 10x10x10mm</p>	<p><b>Grid Cleaner</b></p>	<p><b>Disc Holder</b> (disc not included)</p>
		

## For Cutter Mixers

<p><b>Smooth blade rotors</b> 2,6 lt      3,6 lt</p>	<p><b>Micro-toothed blade rotors</b> 2,6 lt      3,6 lt</p>
	

6 \* Consult price list for additional disc sets



# TRK 45 / 55 / 70

## Combined cutter-slicers

**3 in 1!** With TRK your culinary creativity has no limits. A versatile machine able to prepare an entire menu from hors d'oeuvres to dessert.



### Versatile

Easily change from a **vegetable slicer** to a **food processor/emulsifier** in a matter of seconds.

### User friendly

**Incly System:** inclined motor base by 20° for better ejection of vegetables.

**Automatic speed limitation** for vegetable slicer attachment

Asynchronous motor for **silent** operation and **longer life**.

Waterproof and user friendly **touch button control** panel with pulse function for more precision.

### Easy to clean

Easy cleaning thanks to the **rounded shapes** and **stainless steel** and plastic components.

All parts in contact with food are **100% dishwasher safe**.





## Cutter specifications

Cutter-mixer attachment to mix, blend, chop, mince, emulsify and puree meats and vegetables

Transparent lid with scraper for a **better homogenization**.

**Dedicated rotors** with **smooth** or **microtoothed** blades as well as specific for **emulsions**.

Stainless steel bowl with high chimney to **increase** the real liquid **capacity**, with round corners and ergonomic handle.

Maximum speed up to **3700 rpm**.



Incluy System  
inclined base 20°



Removable shaft

## Vegetable slicer specifications

Vegetable slicer attachment for slicing, shredding, grating and dicing.

**Large** and **long** vegetable **hoppers** integrated in the same design.

**Wide range** of **stainless steel discs** (205mm diameter) for more than 80 different cuts.



Combined cutter-slicer

### TRK45 - 4,5 lt combined cutter-slicer

Speed	Phases	Power	RPM
Variable	1 ph	1000 W	300 to <b>3700</b>

External dimensions (wxdxh)

Slicer: 252x485x505mm Cutter: 252x410x490mm

### TRK55 - 5,5 lt combined cutter-slicer

Speed	Phases	Power	RPM
Variable	1 ph	1300 W	300 to <b>3700</b>

External dimensions (wxdxh)

Slicer: 252x485x505mm Cutter: 252x410x490mm

### TRK70 - 7 lt combined cutter-slicer

Speed	Phases	Power	RPM
Variable	1 ph	1500 W	300 to <b>3700</b>

External dimensions (wxdxh)

Slicer: 252x485x505mm Cutter: 252x410x530mm



# TRS / TRK

## S-shaped slicing discs

### Graters - 2 mm to 9 mm



- 2 mm
- 3 mm
- 4 mm
- 7 mm\*
- 9 mm\*
- for breadcrumbs / potatoes
- for parmesan / chocolate
- \* 7 and 9 mm discs are suitable to grate mozzarella and semi-dry cheese



### Shredders - 2 mm to 10 mm



- 2x2 mm
- 3x3 mm
- 4x4 mm
- 6x6 mm
- 8x8 mm
- 10x10 mm
- 2x8 mm
- 2x10 mm



### Slicers - 0.6 mm to 13 mm



- 0.6 mm
- 1 mm
- 2 mm
- 3 mm
- 4 mm
- 5 mm
- 6 mm
- 8 mm
- 10 mm
- 12 mm
- 13 mm



Unique and exclusive "S" shaped blades for greater efficiency and versatility in cutting. Stainless steel discs for maximum hygiene. 100% dishwasher safe.

**Wavy slicers - 2 mm to 10 mm**

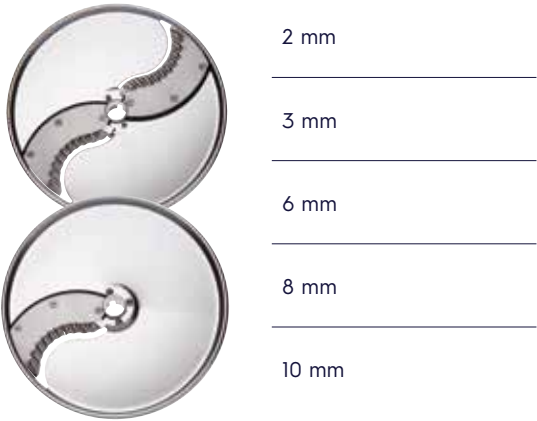

**Dicing grids\* - 5x5 mm to 20x20 mm**

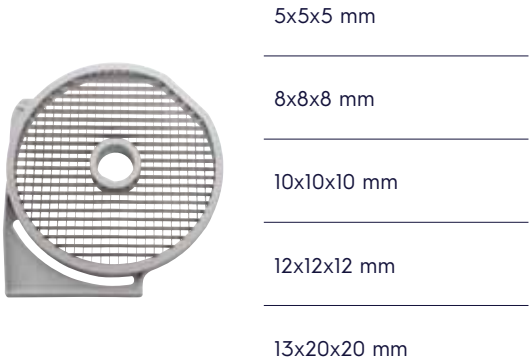

**Grids for chips\* - 6, 8 and 10 mm**

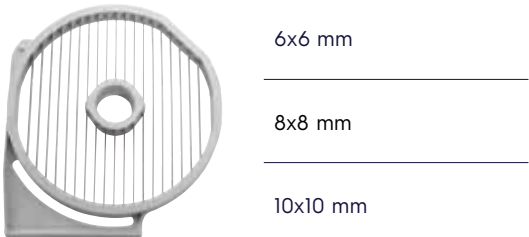

\* to be combined with Slicers and Wavy slicers

# K/TRK Rotors

Smooth or micro-toothed blades to prepare everything from coarse meats to the finest creams.



Smooth blade



Micro-toothed blade



Smooth emulsifier blade



Microtoothed emulsifier blade



Ground meat



Peppers



Chocolate



Grated cheese



Almonds



Tomato sauce



Chicken



Asparagus



Mixed herbs



Hummus

# TrinityPro Vegetable Slicers

Set your imagination free with TrinityPro, the essence of slicing and dicing in a compact, professional solution.



**Compact,  
powerful and  
easy to use**

Professional and high performing in a compact size. **Powerful** single and variable speed solutions with 22 different slicing options for **high quality cuts** at all times. **Simply plug-in and begin.**

**Exceptional dicing  
like never imagined**

**Achieve superior results** even when dicing difficult vegetable such as tomatoes and onions.

**More time for  
your business**

**Tired of wasting work hours cutting vegetables by hand?** With TrinityPro, manual slicing is a thing of the past. **Prepare** mirepoix, salsas and stir fry vegetables **at record speed** leaving more time and money for your business.

**Save up to 95% of your time**



Ingredient	Disc	Q.ty	Time	
			Manual	vs. TrinityPro
Tomatoes	10x10x10mm dicing	2kg	10' 37"	<b>26"</b>
Onions	8x8x8mm dicing	5kg	37' 58"	<b>1' 39"</b>
Mozzarella for pizza	7mm grating	5kg	34' 31"	<b>2' 45"</b>
Carrots	3mm grating	3kg	37' 04"	<b>3' 37"</b>
Cabbage	1mm slicing	3kg	15' 06"	<b>2' 34"</b>
Cucumbers	2mm slicing	2kg	6' 45"	<b>1' 19"</b>
Celery root	4mm shredding	3kg	26' 05"	<b>1' 27"</b>

# Safety assured



## Operator safety guaranteed.

Operation starts only if properly assembled and the cutting blade stops when the lever is lifted.

**Food safety assured** thanks to **BPA-free** materials and compliance with **NSF** standards. **Product safety** in accordance with **international** and **UL** standards.



**PATENTED\***

## Fast, easy and ergonomic

**Consistent results and easy operations with less fatigue**, thanks to the patented\* design of the lever pusher. **Large load capacity** of 1,25 liters, up to 100 settings.

**Easily load long shaped vegetables** through the small feed chutes (Ø 25mm and 55mm).

\* Lever pusher applied for Patent EP19165854 and related family.



## More control and less effort

**Improve your workflow** thanks to the large output chute and side ejection of the vegetables. The **control panel** remains **visible** and **easy to access** during operation. Suitable for containers up to 200mm high.

### Vegetable slicer

Speed	Phases	Power	RPM
1 speed	1 ph	500 W	1500
Variable	1 ph	750 W	500-1200
External Dimensions (mm) WxDxH: 348x315x527			

# 100% Dishwasher Safe

With a **few simple movements** all parts in contact with food can be removed, without tools and are **100% dishwasher safe**. Easy cleaning of control panel with flat, soft-touch buttons. **No dirt traps**.



# TRS Vegetable slicers

Increased productivity, outstanding performance, superior quality and extreme sturdiness.



## Compact, powerful and easy to use

**Compact, powerful** and with **inclined base** (20°) makes loading and unloading operations quick and easy.

Able to slice, shred, grate and dice up to **550 kg/hour**.

**Long life** and **silent operation** thanks to the durable stainless steel construction and asynchronous motor.

**Large hopper** for higher output and processing of large size and unusual shaped vegetables. No need to pre-cut

## Easy to clean

**Maximum cleanability** due to the ergonomic design with rounded shapes and stainless steel parts.



## Wide range of stainless steel discs

(205mm diameter) almost 80 different cuts.





# Ergonomic and user friendly

Large and long vegetable hopper integrated in the same design.

User friendly waterproof control panel with **pulse function** for precise slicing.

**Ergonomic, easy to lift lever:** minimal pressure is required to process vegetables (for right or left hand use).

Automatic start/stop function will stop the machine when the lever hopper is lifted and will restart automatically when lowered, to allow **continuous feeding**.



Long vegetable hopper



Touch control buttons

# Save time and effort

Powerful lever remains in upright position so operator can freely use both hands to feed vegetables.

Variable speed models for more flexibility and precision, speed adjusted to type of cut.

Asynchronous motor for **silent** operation and **longer life**.

High discharge zone permits the use of deep GN containers (up to 20 cm).



Large round hopper (215 cm<sup>2</sup>)



With a few simple movements all parts in contact with food can be removed, without tools, and are **100% dishwasher safe**.



Safety device protects the operator by stopping the machine in case of misuse.

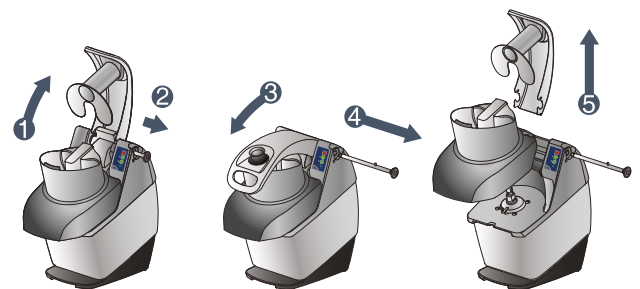

## Vegetable slicer TRS

Speed	Phases	Power	RPM
1 speed	1 ph	370 W	340
	1 ph	500 W	340
	3 ph	500 W	340
2 speeds	3 ph	750 W	340-680
Variable	1 ph	500 W	140 to 750

External dimensions (wxdxh): 252x485x505mm



Stainless steel discs with holder included standard.

# TR210

## Vegetable slicers

Even faster results to ensure quantity with high quality.  
Beyond great performance.



Prepare from 100 to  
1000 covers/day up  
to 2100 kg/h

Slice, dice, shred, cut and  
julienne in record time

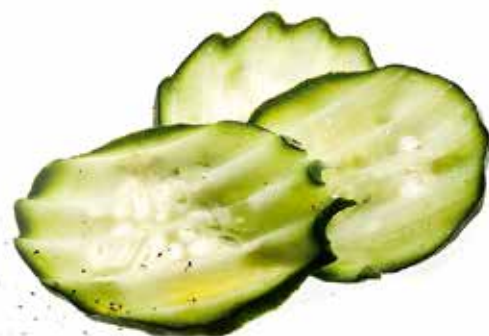

## Easy and precise

**Easy loading** of long and large vegetables with the stainless steel hopper.

**Waterproof** and **easy to clean** control panel (IP55).

**Precise cutting** guaranteed with "Pulse" function.

Stainless steel automatic hopper to cut large quantities of regular shaped fruit and vegetables.

Asynchronous motor for **silent** operation and **longer life**.



Stainless steel manual hopper (optional)



Stainless steel long vegetable hopper (optional)

## All the discs you want

**Myriad shapes** for your original presentations.

**Wide range** of **stainless steel discs** (205mm diameter) for more than 80 different cuts.

**Safe storage** of your discs offered by wall-mounted disc holders.

**Incly System** 20° angled base (for use with manual hopper).



**Excellent hygiene** is ensured for all dishwasher-friendly cutting components.



**Guaranteed ergonomics** and flexibility with the new stainless steel trolley.

# TR260

## Vegetable slicers

A universal slicing machine with a wide variety of accessories to create stylish and imaginative preparations for the largest culinary events.



**TR260**  
with optional lever hopper  
and mobile stand

### Perfect slicing

**Slice up to 2500 kg/h** thanks to automatic hopper, large cutting discs and powerful speed.

Slow blade rotation for **perfect slicing**.

300 mm diameter discs guarantee high productivity.

### User friendly

Safety device protects the operator by stopping the machine in case of misuse.

User friendly **waterproof control panel** with **pulse function** and speed selector (only on 2 speed models) for **precise slicing**.

Asynchronous motor for **silent operation** and **longer life**.



### Maximum versatility

Combine motor base with a variety of optional accessories to suit your needs.



# A vast range of accessories



Automatic hopper for continuous operation and productivity.

For a single load of 6 kg of vegetables (max. 110 mm diam.).



Lever operated hopper.

Vertical motion of the handle for improved ergonomics and space saving.



Long vegetable hopper with 3 tubes (diam. 50 to 70 mm).



Long vegetable accessory for lever operated hopper.



Cabbage hopper for slicing an entire cabbage at once (max. 250 mm diam.). To be combined with cabbage discs.



Stainless steel mobile stand. Disc rack (optional).



Stainless steel trolley for 2/1 GN containers.



Wide selection of slicing discs (Ø 300 mm).

## Vegetable slicer TR260

Speed	Phases	Power	RPM
1 speed	1 ph	1500 W	330
2 speeds	3 ph	2000 W	330-660

External dimensions (wxdxh): 750x380x460 mm

# TrinityPro Cutter Mixers

The perfect choice for chopping, mixing, or emulsifying. Simple and robust multi-purpose cutters ideal for small to medium size kitchens.



**Continuous scraping  
without stopping**



Micro-toothed blade rotor  
(included)

## Tantalize your customer's taste buds

Simply delightful. Prepare the smoothest, creamiest sauces and emulsions that will **take your recipes to a higher level.**

## Incomparable quality

**Fast and even** processing guarantees **consistent high quality results.**

Exceptional mixing of all ingredients quickly and evenly thanks to the special flow generated inside the bowl.

**Liquids can be added during processing** through the central opening in the lid.

## Precision at your finger tips

**Intuitive** frontal control panel with **easy to clean, soft-touch** buttons.

Choose from models with single speed or variable speed with 9 levels for **precise control** of your preparations.

## Total control at all times

**Keep an eye on your preparations.** Check the quality of your results during operation through the transparent lid with integrated scraper for **optimal mixing and emulsifying.**



## Simple & Safe



Bowl, rotor and transparent cover can be **assembled in a matter of seconds**. All parts in contact with food are **100% dishwasher safe**.

**Operator safety assured**, in compliance with **international** and **UL** safety standards.

A magnetic control system stops the machine immediately if the cover is opened. **Food safety** assured thanks to **BPA-free** materials and compliance with NSF standards.



## Consistent mixing

**Continuous scraping without stopping** for a consistent homogenization thanks to the special scraper incorporated into the transparent lid.



## Versatility for creativity

Prepare multiple menu variations with a series of optional accessories.



**2,6 lt bowl**  
in transparent copolyester



**2,6 lt bowl**  
in AISI 304 stainless steel



**3,6 lt bowl**  
in AISI 304 stainless steel



**Smooth blade rotor**

### Cutter mixer 2,6 lt bowl

Speed	Phases	Power	RPM
1 speed	1 ph	500 W	1500
Variable	1 ph	750 W	500-3600
External Dimensions (mm) WxDxH: 247x328x456			

### Cutter mixer 3,6 lt bowl

Speed	Phases	Power	RPM
1 speed	1 ph	500 W	1500
Variable	1 ph	750 W	500-3600
External Dimensions (mm) WxDxH: 252x334x476			

# K45 / 55 / 70

## Food processors

High powered, built to last. The ideal machines for the professional chef. Chop, mince, grind and blend any preparation your recipe requires.



### An ace in your kitchen

4,5, 5,5, and 7 lt capacities are a complement to any size kitchen.

A unique **scraper** allows you to prepare everything from meats to creams.

The unique design of bowl and rotor blades guarantees **perfect results** when mixing both large or small quantities.

Special **pulse function** for **coarse chopping** of large pieces.

### Maximum hygiene

Maximum hygiene thanks to the ergonomic design with **rounded edges**.



Rotor can be placed in a special holder for storage (included).





## Easy to use

**Transparent lid** permits the operator to check the preparation during operation and to **add ingredients** without opening the lid.

Hinged cover, when lifted, remains open to permit a fast, easy and practical check of the preparation.

Waterproof and user friendly **touch button control** panel with pulse function for more precision.

Maximum speed up to **3700 rpm** (variable speed models).



Transparent lid



Variable speed control

## Ergonomy is the key

Stainless steel bowl with high chimney to **increase** the real liquid **capacity**, with round corners and ergonomic handle.

**Dedicated rotors** with **smooth** or **microtoothed** blades as well as specific for **emulsions**.

**Ergonomic handle** for easy placement of the bowl and self-locking mechanism for **maximum stability**.

Asynchronous motor for **silent** operation and **longer life**.

### K45 - 4,5 lt capacity

Speed	Phases	Power	RPM
1 speed	1 ph	750 W	1500
2 speeds	3 ph	900 W	1500-3000
Variable	1 ph	1000 W	300 to <b>3700</b>

External dimensions (wxdxh): 252x410x490mm

### K55 - 5,5 lt capacity

Speed	Phases	Power	RPM
2 speeds	3 ph	1000 W	1500-3000
Variable	1 ph	1300 W	300 to <b>3700</b>

External dimensions (wxdxh): 252x410x490mm

### K70 - 7 lt capacity

Speed	Phases	Power	RPM
2 speeds	3 ph	1200 W	1500-3000
Variable	1 ph	1500 W	300 to <b>3700</b>

External dimensions (wxdxh): 252x410x530mm



Bowl with high chimney (to increase the real liquid capacity)

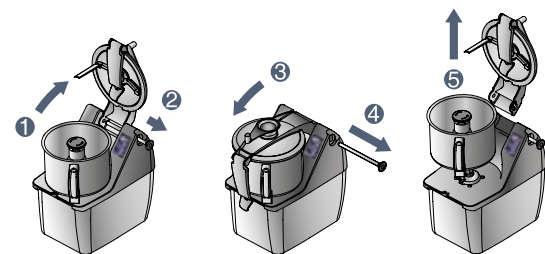

The lid and scraper can easily removed and disassembled **without tools**.



All parts in contact with food are **100% dishwasher safe**.



**Operator safety guaranteed.**

A magnetic control system stops the machine immediately if the cover is opened.

# K120S /180S Food processors

11,5 and 17,5 lt capacities are a complement to any size catering facility.  
Mix and mince quickly and easily to preserve texture and flavour.



K180S

K120S



## For the preparation of sauces, mixing and fine and super fine chopping

**Process in a matter of seconds** without risk of heating or altering the products.

**Large bowl capacities** (e.g. mayonnaise):

- 11,5 lt (K/KE120S) process up to 6 kg
- 17,5 lt (K/KE180S) process up to 8 kg

Stainless steel mobile stand available as an option.

Unique scraper to prepare everything from meats to creams.

## User friendly

**Stability guaranteed** during operations thanks to central position of stainless steel bowl.

Asynchronous motor for **silent** operation and **longer life**.



## Easy and ergonomic

Stainless steel bowl with **transparent lid** permits the operator to check the preparation during use.

**No need to stop the machine during operation.** Ingredients may be added through the opening in the lid.

Waterproof and user friendly **touch button** control panel.

Microtoothed blade rotor, scraper and bowl design ensure **consistent mixing**.

Thick-walled stainless steel bowl with two handles for **easier movement**.

Pulse function for **coarse chopping** of large pieces. (on 2 speed models).

Transparent lid, bowl and rotor can be easily removed without tools.



All parts in contact with food are 100% **dishwasher safe**.

### Extra options

Smooth or serrated stainless steel blade rotor (special serrated rotor for meat processing) upon request

Models with 2 speeds (1500-3000 rpm) or variable speed (300-3500 rpm).



Transparent lid



Touch button control panel



Stainless steel bowl



Microtoothed emulsifier blade rotor



Bowl scraper

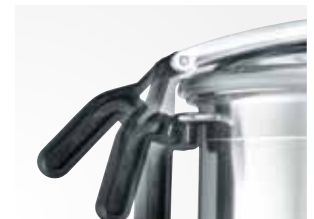

Double safety locking system

#### K120S/KE120S - 11,5 lt capacity

Model	Speed	Phases	Power	RPM
<b>K120S</b>	2 speeds	3 ph	2200 W	1500-3000
<b>KE120S</b>	Variable	1 ph	2200 W	300-3500

External dimensions (wxdxh): 416x680x517mm

#### K180S/KE180S - 17,5 lt capacity

Model	Speed	Phases	Power	RPM
<b>K180S</b>	2 speeds	3 ph	3600 W	1500-3000
<b>KE180S</b>	Variable	3 ph	3000 W	300-3000

External dimensions (wxdxh): 416x680x603mm

## Safety comes first

Double safety locking system **avoids the risk of spillage** and splashing when lid is opened while rotor is coming to a stop.

**Safety guaranteed** by magnetic microswitch which stops the machine if lid or bowl are not correctly positioned.

- 3 devices to **ensure operator safety**:
- 1 hinge sensor when handle is lifted
  - 1 bowl presence sensor
  - 1 cover presence sensor

# Bermixer Pro range Portable mixers

Prepare soups, purees, sauces, creams and whip egg whites quickly and easily with the Electrolux Professional Bermixer Pro.

Exceptionally  
light: less  
than 4 kg!



## No limits to your creativity

The **tube attachment** is ideal for the preparation of creams, soups, sauces, vegetable purees, pancake batter and mousses.

The **whisk attachment** is ideal for whipping creams, beating egg whites or preparing mayonnaise.

## All the speed you need

Electronic speed variation from 500 to 10000 rpm with full load.

**Smart Speed Control:** autoregulation of the power based on the load consistency to ensure a **longer life** and **reduced vibrations**.



## Easy to use

Tube, shaft and blade are **easily disassembled** without tools.



A special wall support, supplied as standard, holds the unit and tools, when not in use.

## User friendly and ergonomic

Double-fan air cooling system guarantees **longer working time** without overheating.

**Overload alarm indicator** in the control panel will light if the unit is used improperly.

The special lipped design of the blade protection **avoids splashing**.

Ergonomic handle for a comfortable use.

Thermal insulated plastic insert on the tube.

Safe handling thanks to the heat protected grip.

## Smart

Visible control panel with **speed adjustment** and **warning light**.

Flat motor base connected to the tube via **"Bayonet" system**.



All parts in contact with food are 100% **dishwasher safe**.



Special lipped design of the blade protection

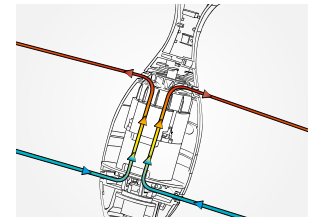

Air cooling system



Reinforced "Bayonet" system



Ergonomic handle



Disassembly of tube, shaft and blade without tools and thermal insulated plastic handle

## Optional accessories



**Adjustable rail** to sustain portable mixer in containers (must to be used together with holder).



**Holder** to support portable mixer in containers.

# A complete range

## Bermixer PRO Plus (up to 9000 rpm)

## Bermixer PRO Turbo (up to 10000 rpm)



Models	BP3535	BP3545	BP4535	BP4545	BP4555	BP5545	BP5555	BP6545	BP6555	BP6565	BP7555	BP7565
Power	350 W		450 W			550 W		650 W			750 W	
Tube	35 cm	45 cm	35 cm	45 cm	55 cm	45 cm	55 cm	45 cm	55 cm	65 cm	55 cm	65 cm
Capacity up to	30 lt	50 lt	80 lt	100 lt	120 lt	150 lt	170 lt	200 lt	220 lt	240 lt	270 lt	290 lt



# Speedy mixer range

## Portable mixers

Versatile tools for your busy kitchen! Multifunctional and easy to handle, these portable mixers allow you to serve a variety of foods quickly and easily.



For the preparation of small quantities of soups, purées, sauces, creams and much more.

The ergonomic, easy to grip handle assures **maximum control** with less fatigue.

The 250 W motor is available with fixed or variable speed (**max speed 15000 rpm**).

Thanks to the easy tool junctions, the motor unit and tube can be **disassembled without tools** for cleaning.

The tube and blade are in stainless steel and the motor body is in special alimentary plastic for a **longer life**.

An optional whisk is available for variable speed models.

### Speedy mixer (up to 15000 rpm)

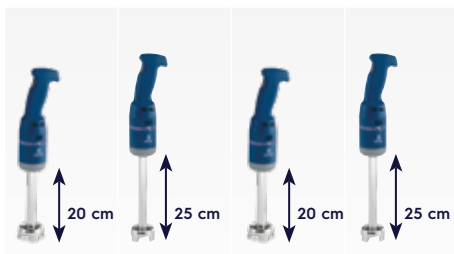

Disassembly without tools



Model	SMT20W25	SMT25W25	SMVT20W25	SMVT25W25
Power (W)	250 W		250 W variable speed	
Tube (cm)	20 cm	25 cm	20 cm	25 cm
Weight (kg)	1,4 kg	1,45 kg	1,4 kg	1,45 kg
Capacity	ideal for small quantities			



Blade protection

# TBX Pro - TBM150 Turboliquidizers

They are high capacity appliances to mix, blend, liquefy and emulsify a wide variety of preparations.



**TBX Pro**  
up to 700lt



**TBM150**  
up to 1000 lt

**TBX Pro:**

## Pro in Sturdiness and Performance

Stainless steel solution to process up to 700 liters of food directly in the cooking container in a short time.

## Pro in Effortless Cleaning

All components are in stainless steel, easy to disassemble and dishwasher safe (except bearings).

## Pro in Simple Operations

Only one person is needed to move the appliance, regulate the height and operate directly in any cooking equipment to prepare delicious recipes.

## Pro in Flexibility and Modularity

Easily adaptable to any boiling pot or brasing pan. Able to process liquids as well as thick consistencies: vegetable soups, sauces, blending powders and even preparing fresh mashed potatoes.





## TBX Pro



### Variable speed

630 to 1700 rpm  
in 20 steps, 3-phase.  
Perfect for any consistency  
and cooking container.

**Motor only:** need to order also  
tube(s) & tool(s)



### 2 speed

850/1700 rpm, 3-phase

**Motor only:** need to order also  
tube(s) & tool(s)



### 1 speed

1650 rpm, 3-phase

**Ready for use:**  
tube and soup tool included

## Optional accessories for TBX Pro



Long tube 568 mm

Standard tube 448 mm

Short tube 348 mm



Soup grid Ø 6-8mm  
(included in soup tool)



Soup grid Ø 8-10 mm



Soup grid Ø 19 mm



Soup tool for boiling pots



Soup tool for braising pans



Purée tool for boiling pots



Purée tool for braising pans

### Turboliquidizers

Model	Speed	rpm/min	Power	Food consistency
TBX Pro	1 speed	1600	1500 W	for liquids/semiliquids (soups, liquid dough)
TBX Pro	2 speeds	850/1700	2200 W	for liquids/semiliquids, mixing powders
TBX Pro	variable speed	from 630 to 1700	1500 W	for liquids and thick food (purée)
<b>External dimensions (WxDxH) 628x1556x1122mm</b>				

Model	Speed	rpm/min	Power	Food consistency
TBM150	1 speed	1650	3000 W	for liquids, up to 1000 lt
TBM150	2 speeds	830/1600	4500 W	for liquids and purée/thick consistency
<b>External dimensions (WxDxH) 664x1852x1475mm</b>				

# BE5 / BE8 5 and 8 lt planetary mixers

Maximum performance. Compact yet powerful. Sturdiness above all.



**BE8**  
without accessory hub



**BE5**  
with accessory hub

**Guarantee superior performance in kneading, blending and whipping thanks to:**

- ▶ the **exclusive design** of the planetary mechanism, for a unique movement
- ▶ the variable speed rotation of the planetary mechanism **from 20 to 220 rpm**
- ▶ the **variable speed rotation** of the tools from 67 rpm to 740 rpm
- ▶ the tools which perfectly adapt to the bowl for **uniform mixing** of even small quantities
- ▶ simple movement of the splash guard activates the raising and lowering of the bowl
- ▶ asynchronous motor for **silent** operations and **longer life**.



Stainless steel spiral hook, paddle and whisk

**3 tools - 100% efficiency**

**100%** stainless steel tools

**100%** more resistant for longer life

**100%** dishwasher safe  
(tools, bowl and splash guard)





Sturdy metal accessory hub able to **withstand heavy usage** (on selected models).



Powerful asynchronous motor for **silent operation and longer life.**



Ergonomic knob regulates the **variable speed** of the planetary mechanism from 20 - 220 rpm.



Transparent splash guard with innovative shape to **easily add ingredients** during operations.



Simple **"clip"** system without screws for **easy removal** of the guard for cleaning.



**Double-handled**, 8 lt stainless steel bowl (single handle on 5 lt model).



**Mince and prepare pasta** with the optional accessories (for models with K accessory hub).

## Safety comes first

Your health is important to us, always.

**Bowl detection device** which allows the mixer to switch on only when the bowl is properly positioned with the safety screen\*.

\* UNI EN 454:2015 Food Processing Machinery - Planetary Mixers - Safety And Hygiene Requirements. This European Standard specifies safety and hygiene requirements for the design and manufacture of fixed bowl planetary mixers with a tool having a planetary movement by using two parallel axes. The capacity of the bowl is greater than or equal to 5 L and less than or equal to 200 L.

**Maximum reliability guaranteed. BPA free transparent screen:** impact resistant, stays clear and durable even after hundreds of dishwashing cycles.

The **absence of BPA** contributes to make the splashguard safe for your health.



# XBE /XBM table top 10 and 20 lt planetary mixers

Sturdy and built to last. Electrolux Professional offers a wide range of planetary mixers from 10 to 80 lt to suit all requirements of your busy kitchen.



XBE10

XBE20



**Knead all types of doughs and pastry, mix meats and sauces and emulsify creams**

**Electronic or mechanical** speed variator (depending on model).

Motor with frequency variator permits a precise adjustment of the planetary mechanism speed (from 26 to 180 rpm for 10 lt models and from 30 to 180 rpm for 20 lt models).

Powerful asynchronous motor for **silent operations and longer life.**

Models available with **accessory hub** (type H).

**Water protected** planetary system and control panel, equipped with 0-59 minute timer.



## Simple, ergonomic, safe

The simple movement of the safety screen raises and lowers the bowl while at the same time stops the motor (10 lt models).

The safety screen can be easily removed for **cleaning**.

**Stainless steel column and feet** for higher resistance and hygiene (on selected models).

Height adjustable feet to ensure stability.

Waterproof, user friendly touch button control panel for **improved ergonomics**.

Stainless steel **removable** rotating **safety screen**, equipped with removable spout

Lever for raising and lowering the bowl (20 lt).



Transparent safety screen (10 lt)



Stainless steel column (on specific models)



Touch button control panel



Removable spout

## Accessories

Supplied with **stainless steel bowl** and **3 tools**: stainless steel wire whisk, robust paddle and spiral hook.

Tools rotate at variable speeds (from 82 to 570 rpm for 10 lt models and from 73 to 440 rpm for 20 lt models).



Spiral hook, paddle and whisk



A 10 lt **bowl reduction kit** (bowl, whisk, paddle and spiral hook) is available on request (20 lt models).

## Safety comes first

Your health is important to us, always.

**Blind/solid safety screen** which will limit flour and unsafe dust particle, e.g. when used in bakery and pastry preparation (20 lt).

**Bowl detection device** which will allow the mixer to switch on only when the bowl is properly positioned with the safety screen\*.

\* UNI EN 454:2015 Food Processing Machinery - Planetary Mixers - Safety And Hygiene Requirements. This European Standard specifies safety and hygiene requirements for the design and manufacture of fixed bowl planetary mixers with a tool having a planetary movement by using two parallel axes. The capacity of the bowl is greater than or equal to 5 L and less than or equal to 200 L.

**Maximum reliability guaranteed. BPA free transparent screen:** impact resistant, stays clear and durable even after hundreds of dishwashing cycles (10 lt).

The **absence of BPA** contributes to render the product safe for your health.

# XBE / XBM / MBE floor standing 20, 30 and 40 lt planetary mixers

20/30/40 lt professional mixers are an essential item for all kitchens using fresh ingredients to prepare pastry bases, creams, mousses and mixtures of all types.



XBM20



XBM30

## 20/30 lt planetary mixers

Powerful asynchronous motor for **silent operation** and **longer life**.

**Electronic** or **mechanical** speed variator (depending on model).

The planetary mechanism rotates at speeds of: 30 to 180 rpm (20/30 lt).

Supplied with **stainless steel bowl** with easy to grip handles and **3 tools**: stainless steel wire whisk, robust paddle and spiral hook.

Tools rotate at speeds from 73 to 440 rpm.

**Water protected** planetary system and control panel, equipped with 0-59 minute timer.

**Stainless steel column and feet** for higher resistance and hygiene (on selected models).

Planetary mixers can be easily moved thanks to the **wheel kit accessory** (optional).

Models available with **accessory hub** (type H) and a wide range of optional accessories.



Blind/solid safety screen



Planetary mechanism

## 20/30/40 lt planetary mixers

### Safe and ergonomic

The BPA free safety screen and stainless steel wire structure can be **easily removed** for cleaning.

The stainless steel wire structure is equipped with a spout to add ingredients during preparation.

Lever for raising and lowering the bowl.

Wheel kit and bowl trolley (optional).

A bowl reduction kit (bowl, whisk, paddle and spiral hook) is available, on request.



MBE40

## Safety comes first

Your health is important to us, always.

**Blind/solid safety screen** which will limit flour and unsafe dust particle, e.g. when used in bakery and pastry preparation.

**Bowl detection device** which will allow the mixer to switch on only when the bowl is properly positioned with the safety screen\*.

\* UNI EN 454:2015 Food Processing Machinery - Planetary Mixers - Safety And Hygiene Requirements. This European Standard specifies safety and hygiene requirements for the design and manufacture of fixed bowl planetary mixers with a tool having a planetary movement by using two parallel axes. The capacity of the bowl is greater than or equal to 5 L and less than or equal to 200 L.

## 40 lt planetary mixers

Specially designed for intensive kneading as well as blending and whipping preparations.

Powerful asynchronous motor for **silent operation** and **longer life**.

**3 fixed speeds** (40, 80 and 160 rpm) and **electronic variable speed** from 30 to 175 rpm and **timer (0-59 min.)**.

Supplied with **stainless steel bowl** and 3 tools (**reinforced whisk**, paddle, spiral hook).

Tools rotate at speeds from 94 to 540 rpm.



Stainless steel column (on request)



Kit wheels



3 tools: spiral hook, paddle, reinforced whisk (specific for MB/MBE40)

# BMX/BMXE/XBE 60 and 80 It planetary mixers

60/80 It high performing, powerful and sturdy mixers able to withstand intensive use.



BMX60S

XBE80S



## Speed and power

Powerful asynchronous motor for **silent operation** and **longer life**.

**Electronic, electromechanical** or **mechanical** speed variator (depending on model) with speeds ranging from 20 to 180 rpm.

Supplied with **stainless steel bowl** with easy to grip handles and **3 tools**: stainless steel wire whisk, robust paddle and stainless steel spiral hook.

Tools rotate at speeds from 62 to 560 rpm.

Control panel with **timer**, bowl lighting, on/off and speed control.

The BPA free blind/solid safety screen can be easily removed for cleaning.

Motorized bowl movement (on specific models) Models available with **accessory hub** (type H) and a wide range of optional accessories.

**Bowl trolley** with wheels and bumper facilitates bowl movement (standard on 80 It).

A **bowl reduction kit** (bowl, whisk, paddle and spiral hook) is available on request



Robust stainless steel hook



Mechanical speed variation



Bowl lighting



# A complete range



Planetary mixers capacity	5 lt	8 lt	10 lt	20 lt	20 lt	30 lt	40 lt	60 lt	80 lt
Hook, kg*	1,5	2,5	3,5	6	6	7	10	20	25
Whisk, eggs**	10	14	18	32	32	50	70	100	120
Table top	•	•	•	•					
Freestanding					•	•	•	•	•

\* Hook: kg of flour for dough (with 60% moisture content)

\*\* Whisk: max. number of egg whites

## Accessories for all needs



Meat mincer on hub



Vegetable slicer



Puree strainer



## Safety comes first

Your health is important to us, always.

**Blind/solid safety screen** which will limit flour and unsafe dust particle, e.g. when used in bakery and pastry preparation.

**Bowl detection device** which will allow the mixer to switch on only when the bowl is properly positioned with the safety screen\*.

\* UNI EN 454:2015 Food Processing Machinery - Planetary Mixers - Safety And Hygiene Requirements. This European Standard specifies safety and hygiene requirements for the design and manufacture of fixed bowl planetary mixers with a tool having a planetary movement by using two parallel axes. The capacity of the bowl is greater than or equal to 5 L and less than or equal to 200 L.

# Bakery, pastry and pizza - 20, 30 and 40 lt planetary mixers

Electrolux Professional offers a complete range of planetary mixers specially designed to withstand the strong demands of bakery, pastry and pizza preparations.



MB40



## 40 lt planetary mixers

Powerful asynchronous motor (2200 W) for **silent operation** and **longer life**.

**Electromechanical 3 fixed speeds** (40, 80 and 160 rpm).

Control panel with stop button, 3 speeds and **0-15 minute timer**.

**Stainless steel bowl** and 3 tools (reinforced whisk, paddle and spiral hook).

Tools rotate at speeds 125, 250, 500 rpm.

Lever for raising and lowering the bowl.

A wide range of accessories such as bowl scraper, bowl trolley and reduction bowl kits (MB/MBE40).



Bowl scraper



Bowl trolley



Spiral hook, paddle, reinforced whisk (MB/MBE40)



MBE40



## 40 lt planetary mixers

Powerful asynchronous motor (2200 W) for **silent operation** and **longer life**.

**3 fixed speeds** (40, 80 and 160 rpm) and **electronic variable speed** from 30 to 175 rpm.

Supplied with **stainless steel bowl** and 3 tools (**reinforced whisk**, paddle and spiral hook).

Tools rotate at speeds from 94 to 540 rpm.

**Water protected** planetary system and control panel, equipped with 0-59 minute timer.

Lever for raising and lowering the bowl.



XBB30



## 20/30 lt planetary mixers

Powerful asynchronous motor (1500 W) for **silent operation** and **longer life**.

**3 fixed speeds** (40, 80 and 160 rpm) and **electronic variable speed** from 30 to 175 rpm.

Supplied with **stainless steel bowl** and 3 tools (**reinforced whisk**, paddle and spiral hook).

Tools rotate at speeds from 73 to 425 rpm.

**Water protected** planetary system and control panel, equipped with 0-59 minute timer.

Lever for raising and lowering the bowl

Reinforced column and base for **added support** and **stability**.

**Wheel kit** and **bowl trolley** optional.

A **bowl reduction kit** (bowl, whisk, paddle and spiral hook) is available on request



Removable spout

## Bakery, pastry and pizza

Model	Capacity	Hook *	Whisk **
XBB20	20 lt	7 kg	32
XBB30	30 lt	8 kg	50
MB40	40 lt	10 kg	70
MBE40	40 lt	10 kg	70

\* Hook: kg of flour for dough (with 60% moisture content)

\*\* Whisk: max. number of egg whites

## Safety comes first

Your health is important to us, always.

**Blind/solid safety screen** which will limit flour and unsafe dust particle, e.g. when used in bakery and pastry preparation.

Stainless steel **removable** rotating **safety screen**, equipped with removable spout

**Bowl detection device** which will allow the mixer to switch on only when the bowl is properly positioned with the safety screen\*.

\* UNI EN 454:2015 Food Processing Machinery - Planetary Mixers - Safety And Hygiene Requirements. This European Standard specifies safety and hygiene requirements for the design and manufacture of fixed bowl planetary mixers with a tool having a planetary movement by using two parallel axes. The capacity of the bowl is greater than or equal to 5 L and less than or equal to 200 L.

# T series Vegetable peelers

Electrolux Professional peelers solve the problem of best removing not only potato peels but also peeling many other vegetables or cleaning shellfish.

**5 kg vegetable peeler** with its high quality stainless steel finish guarantees longer service life



T55



**Extremely simple control** with on/off button and timer.

**No risks.** Safety interlock turns off the motor if the cover or outlet are opened.

Ergonomic handle and outlet **facilitate collection** of the vegetables once peeled.

**Optimum performance:** 5kg loading capacity with an output of 80 kg/hr.

Transparent cover allows vegetables to be **checked during operation.**

**Lid** can be **easily removed** without tools and is dishwasher safe.

Removable rotating plate covered with an abrasive material that guarantees **durability** and **long life.**

**Knife plate** (for a smooth cut of the peel), **washing plate** (for cleaning vegetables that don't require peeling) and stainless steel **filter table** available upon request.

Asynchronous motor for **silent** operation and **longer life.**



Ergonomic handle and outlet



Knife plate (optional)



Transparent lid



T5E/T8E



**5/8 kg vegetable peelers** (table top) able to satisfy the requirements of small to medium size restaurants

**Maximum output** guaranteed from **80 kg (T5E) to 130 kg (T8E) per hour.**

Specific models available for **cleaning shellfish** (T5M/T8M) with a reduced speed (208 rpm), seashell plate and cylinder.

**Versatile** with optional drying basket for washing and spin drying salads, herbs or other leafy vegetables.

Transparent lid to observe the **peeling process** without stopping the machine.

Removable handle connected to a water supply can be used during peeling or for cleaning operations.

Strong rubber feet **guarantee stability** during operation.

Asynchronous motor for **silent** operation and **longer life.**

Removable rotating plate covered with an abrasive material that guarantees **durability** and **longer life.**

Stainless steel removable peeling chamber.

A special kit, with abrasive plate and cylinder, is available upon request to convert the shellfish cleaner into vegetable peeler.



## Maximum hygiene

Integrated stainless steel filter can be easily removed and is dishwasher safe.

**Maximum hygiene guaranteed.** All parts in contact with food can be removed for fast and easy cleaning.



Drying basket (optional)



Seashell plate for TM models



Transparent lid with spray gun



Removable stainless steel filter



T10E/T15E



**10/15 kg vegetable peelers** that can be used for multiple operations such as: washing, scrubbing, peeling and even drying due to the wide choice of optional accessories

Ideal for restaurants, catering and delicatessen, with peeling capacities between **160/240 kg/hr.**

High quality peeled vegetables with **little waste** thanks to the abrasive material covering the rotating plate.

Door with constant pressure control system for the **safe unloading of the vegetables.**

**Safety:** the motor stops if the lid or door is opened during operation.

**Simple and easy to use** waterproof touch button control panel with on/off and programmable timer.

Asynchronous motor for **silent** operation and **longer life.**

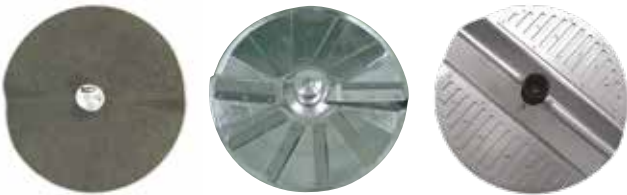

Unloading hole



Abrasive plate and cylinder

**Sturdy** stainless steel construction with a transparent lid made of damage resistant plastic to allow **complete visibility** of the peeling cycle during operation.

Removable rotating plate covered with an abrasive material that guarantees **durability** and **longer life.**

Special models available with an abrasive cylinder for a **faster peeling** (hard tubers).

Removable handle connected to the water supply or water inlet can be used as water gun for cleaning the peeling chamber.

Stainless steel filter table available on request.

More flexibility with optional plates (knife plate, onion plate, garlic/shallot plate, mussel cleaner, brushing plate).

Drying basket (as optional accessory).



Brushing plate (optional)



Drying basket (optional)



T25E



Ti25

**25 kg vegetable peelers** able to satisfy the needs of even the largest customers thanks to their peeling capacity over **400 kg/hr**

**Simple and easy to use** waterproof touch button control panel with on/off and programmable timer.

Door with constant pressure control system for the **safe unloading of the vegetables**.

The cylinder and removable rotating plate are covered with an abrasive lava stone material that guarantees **durability and longer life**.

**Safety:** the motor stops if the lid or door is opened during operation.

**No blockage** of peels thanks to special size and design of drain hole.

Optional mobile trolley with filter tray (for T25E).

Asynchronous motor for **silent** operation and **longer life**.



Unloading door



Drain hole

Model	Capacity	Dimensions (wxdxh)	Notes
T5S	5 kg	314x485x450 mm	
T5E/T5M	5 kg	424x390x590 mm	special model for seashells
T8E/T8M	8 kg	422x396x676 mm	special model for seashells
T10E	10 kg	440x690x680 mm	
T15E	15 kg	440x690x750 mm	
T25E	25 kg	585x785x1215 mm	
Ti25	25 kg	565x880x1425 mm	inclined body

Stainless steel cylinder (540mm diam.) tilted at 18° towards front to **facilitate loading and unloading operations**.

Transparent lid with microswitch to stop the machine if lid is opened **guaranteeing operator safety**.

Stainless steel **filter table incorporated** as standard (Ti25).

# Vegetable washers and Spin dryers

Choose from a wide range of vegetable washers and spin dryers, essential components for small, medium and large size kitchens.



LVA100



## Vegetable washer and dryer in one machine.

The washing effect is obtained by combining basket rotation and water turbulence generated by a pump.

Designed for the efficient and **safe treatment** of all types of vegetables.

Complete stainless steel construction guarantees **long term reliability**.

Integrated dispenser with liquid for sanitizing vegetables (activated during a specific cycle).

3 preset cycles according to the desired type of wash (light/heavy wash).

Basket with **2 speed rotation**: washing (60-70 rpm), drying (270-310 rpm).

**Advanced programmable model** with automatic and manual cycles and self-cleaning cycle.

Spray and/or immersion washing, depending on cycle.

**Avoid damage to delicate items** by regulating the power of the washing water.

Efficient and **easy to clean** filtering system and well with rounded corners.

Operator safety thanks to microswitch which stops the machine if the lid is opened.

Asynchronous motor for **silent** operation and **longer life**.

Model	Load capacity	Basket volume	Power
LVA100B	2-6 kg	30 lt	900 W

External dimensions (wxdxh): 700x700x1000mm





ELX65



EL40

**Spin dryers** ideal for drying lettuce, spinach, leeks, parsley, swiss chard and cabbage.

Very short drying time (1-2 minutes) **preserves the flavour and texture** of all leafy vegetables until served. Stainless steel construction guarantees **hygiene** and is **resistant to corrosion**.

**Waterproof touch button control** panel for easy cleaning is protected even against strong jets of water (IP55).

Drying basket either in stainless steel/aluminium (only ELX65) or high quality resin.

Basket rotation speed **ideal for drying fragile items** without crushing them (330 rpm for ELX65; 450 rpm for EL40).

**Residual water is easily eliminated** through an outlet pipe at the bottom of the well.

Asynchronous motor for **silent** operation and **longer life**.

**Safety:** the motor stops when the lid is opened.

**Two cycles** for all types of vegetables: "automatic" (75 seconds) which alternates rotation with several sudden stops (for all vegetables); "manual" thanks to the adjustable timer 0-59 min. (for delicate items).

Model	Load capacity		Basket volume	Power
	Heavy veg.	Lettuce heads		
EL40	5 kg	9	32 lt	370 W

External dimensions (wxdxh): 460x540x800mm

Model	Load capacity		Basket volume	Power
	Heavy veg.	Lettuce heads		
ELX65	10 kg	18	65 lt	750 W

External dimensions (wxdxh): 578x639x1005mm



Touch button control



Residual water drain



Stainless steel/aluminium drying basket

# A complement for bakery, pastry and pizza

Electrolux Professional offers a wide range of dough kneaders and dough sheeters to suit the needs of all bakery, pastry and pizza preparations.



BPO



## 25/40 It fork kneaders

(approx. 15/24 kg of dough per operation).

2 speed motor for **optimum kneading quality**: slow speed (45 rpm) and 2nd speed (90 rpm).

**Precise control** with touch button panel with timer (0-59 min.).

Welded base for added **support and stability**.

**Operator safety** assured thanks to the particular head raising and instantaneous locking system. The machine will not start if the bowl is not correctly placed on the base.

**Maximum hygiene** thanks to the transparent screen: allows products to be added during operation and avoids the emission of flour into the work area. **Removable stainless steel bowl**.

Asynchronous motor for **silent operation** and **longer life**.



ZSP

## 12 to 49 It spiral kneaders

(approx. 10/40 kg of dough per operation)

**Sturdy and reliable** construction in painted steel.

When screen is raised the motor automatically stops, guaranteeing **operator safety**.

High capacity stainless steel bowl with rounded bottom **facilitates cleaning**.

All models are single speed, with **resistant stainless steel mixing arm**.

Carefully designed motor guarantees **long life and reliability**.

**Larger models** equipped with central shaft (38, 49 It).

Asynchronous motor for **silent operation** and **longer life**.



PSR

## 50 and 90 It spiral kneaders

(approx. 26/48 kg of dough per operation)

**Sturdy and reliable** construction in painted steel.

Control panel with on/off switch and timer.

When screen is raised the motor automatically stops, guaranteeing **operator safety**.

Stainless steel bowl and spiral tool which prevents dough from rising.

**Two speed** kneading motor with manual speed variation.

**Protective screen** to avoid the emission of flour into the work area.

Rounded bottom stainless steel bowl **facilitates cleaning**.

Asynchronous motor for **silent operation** and **longer life**.





LMP400



LMP500

## Manual dough sheeter table top model.

**Compact** and easy to move.

Teflon coated cylinders (Ø 60 mm).

Working width: **400 mm**.

Thickness: **0,1 to 28 mm**.

Removable stainless steel slides/flaps.

## Motorized dough sheeter table top model.

Wire safety screen.

Teflon coated removable flaps facilitate the sliding of the dough.

Chrome plated steel cylinders (Ø 60 mm) may be adjusted depending on the thickness requested.

Thickness: **0,1 to 34 mm**.

Working width: **500 mm**.

Manual lever to invert cylinder rotation.

Flour container fixed on the top of the machine.

Remote foot pedal to change rolling direction (optional accessory).

Optional trolley available.

Asynchronous motor for **silent** operation and **longer life**.

## Motorized belt dough sheeters - table top and floor standing models.

Models with **1 speed** or **variable speed**.

Tables can be raised to **save space**.

Wire gratings with **safety** microswitch to stop motor if raised over a particular level.

Teflon coated removable slides facilitate the sliding of the dough.

Chrome plated steel cylinders (Ø 60 mm) may be adjusted depending on the thickness requested.

Manual lever to invert cylinder rotation.

Working widths: **500 mm** or **600 mm**  
(depending on model).

Flour container fixed on the top of the machine.

Remote foot pedal to change rolling direction  
(optional accessory).

Asynchronous motor for **silent** operation and  
**longer life**.



Remote foot pedal  
(optional)



Cutting module for croissants  
(optional on selected models)

# A complement to your kitchen

The new range of appliances which provides the highest quality and hygiene in line with every professional kitchen.



CPX

A versatile and easy to use, single chute, **electric bread slicer**. Well suited for fast and efficient service in high volume catering establishments.

Slices from 130 to 260 slices/minute (2 baguettes) and operates three to **six times faster** than slicing by hand with **optimal results**. Slices can be adjusted from **8 to 60 mm thick**.

**Great for long loaves or baguettes.** Simply insert the bread into the vertical spout (175x110mm) and it will be cut automatically.

**Maximum safety.** Fitted with an original safety device which prohibits access to the blade especially during cleaning operations. The blade is immobilized and covered as soon as the bread evacuation door is raised.

**Waterproof** touch button control panel with start/stop and pulse button for controlled slicing.

**Maximum hygiene guaranteed.** The optional stainless steel table can suit GN 1/1 polycarbonate trays to collect the sliced bread and avoid handling.

Asynchronous motor for **silent operation and longer life**.



EVP45F

Free-standing and **table top vacuum packers**, from 8 to 60 m<sup>3</sup>/h (100 to 800 meals/day).

Stainless steel construction and domed transparent plexiglass lid **suitable for use with all types of food**.

Easy to program, digital control panel guarantees **optimal vacuum pressure** and heat seal times.

Models pre-arranged for connection to inert gas for **packing delicate foods**.

**Highest levels of hygiene** and ease of cleaning thanks to pressure chamber with rounded corners.

**Maximum reliability.** Warning light indicates any malfunctioning in the vacuum packing process and stops operation before the products are heat sealed, thus allowing the bags to be reused.

Models available with printer for adhesive labels, according to HACCP standards.

Asynchronous motor for **silent operation and longer life**.



EVP45NXT



MMG12/22

## Meat mincer/graters ideal for mincing meats as well as grating bread, cheese and nuts.

Body in die-cast aluminium and stainless steel for **added strength and reliability**.

**Operator safety guaranteed.** Microswitch positioned on the handle prevents accidental contact. Protection grill is positioned beneath the grating cylinder and in front of the shredder attachment, to avoid injury.

Removable stainless steel grinding unit (diam. 70mm) can be **easily cleaned**.

**Grater:** Motor speeds - 900 rpm (MMG12) or 1400 rpm (MMG22). Steel roller and stainless steel collection container. Output: 50/130 kg cheese/hr and 100/150 kg bread/hr.

**Meat mincer:** Motor speeds - 140 rpm (MMG12) or 210 rpm (MMG22). Chopper end, feed pan, collecting container, plate and self-sharpening knife in stainless steel. Output: 200/300 kg meat/hr.



Vertical food slicers

## An extensive range of food slicers which provide a rational solution for any kind of customers: restaurants, catering, supermarkets and delis.

Ideal for slicing raw meats, salamis and pressed meats thanks to the variable blade diameters from 250 to 370 mm, constructed in polished, satin finished, anodized aluminium.

**Versatile.** Prepare square, round or rectangular slices. Variable slicing thickness (depending on the model). Models available with special tightening arm.

Choose between **vertical** or **gravity** slicers, gear or belt transmission based on specific needs and types of products to be sliced.

Poly-V belt drive system is ideal for normal daily use, gear transmission for heavy duty operations.

Ventilated blade drive motor for **continuous use**.

Built-in precision sharpener.

Cleaning is made easy since blade cover, product deflector and carriage system can be easily removed.

**Operator safety** assured since gauge plate interlock allows the removal of the carriage only if the appliance is switched off.

Permanently mounted blade guard ring protects user from cutting blades during operation and cleaning.

Asynchronous motor for **silent** operation and **longer life**.



Gravity food slicers





# Essentia Teamed to serve you. Anytime, anywhere

Essentia is **the heart of superior Customer Care**, a dedicated service that ensures your competitive advantage. Provides you with the support you need and takes care of your processes with a **reliable service network**, a range of tailor-made exclusive services and innovative technology.

You can count on more than **2,200 authorized service partners**, **10,000 service engineers** in more than **149 countries**, and over **170,000 managed spare parts**.

## Service network, always available

We stand ready and committed to support you with a **unique service network** that makes **your work-life easier**.

## Service agreements, you can trust

You can choose from **flexible tailor-made service packages**, according to your business needs, offering a variety of maintenance and support services.

## Keep your equipment performing

Undertaking correct maintenance in **accordance with Electrolux Professional Manuals** and recommendations is essential to avoid unexpected issues.

**Electrolux Professional Customer Care** offers a number of **tailor-made service packages**. For more information contact your preferred **Electrolux Professional Service Partner**.



Watch  
the video  
and find out  
more!





Excellence is central to everything we do.  
By anticipating our customers' needs, we strive for  
Excellence with our people, innovations, solutions and services.  
To be the OnE making our customers' work-life easier,  
more profitable – and truly sustainable every day.

Follow us on



[www.electroluxprofessional.com](http://www.electroluxprofessional.com)

## Excellence with the environment in mind

- ▶ All our factories are ISO 14001-certified
- ▶ All our solutions are designed for low consumption of water, energy, detergents and harmful emissions
- ▶ In recent years over 70% of our product features have been updated with the environmental needs of our customers in mind
- ▶ Our technology is RoHS and REACH compliant and over 95% recyclable
- ▶ Our products are 100% quality tested by experts

