







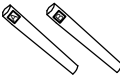
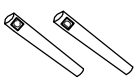

ASSEMBLY INSTRUCTIONS

MODEL : LW 1810

PART LIST		
1	Chair Body 	1 PC
2	Leg Frame 	1 PC
3	Front Leg 	2 PCS
4	Back Leg 	2 PCS

HARDWARE LIST			
A	JCBC M6x50mm 	8 PCS	
B	Spring Washer M6x13mm 	12 PCS	
C	Flat Washer 1/4 x 9mm 	8 PCS	
D	JCBC M6x60mm 	4 PCS	
E	Allen Key 	1 PC	

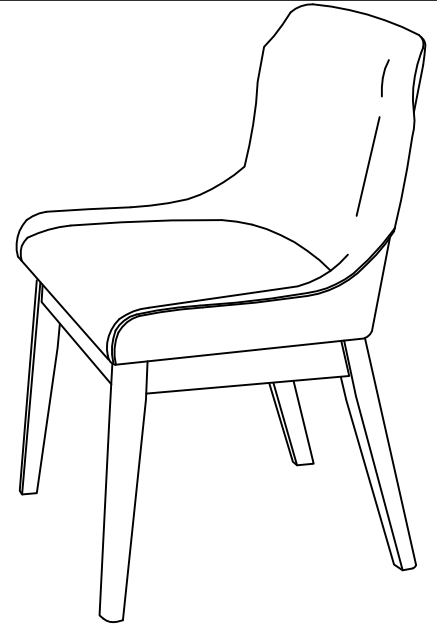

Step 1

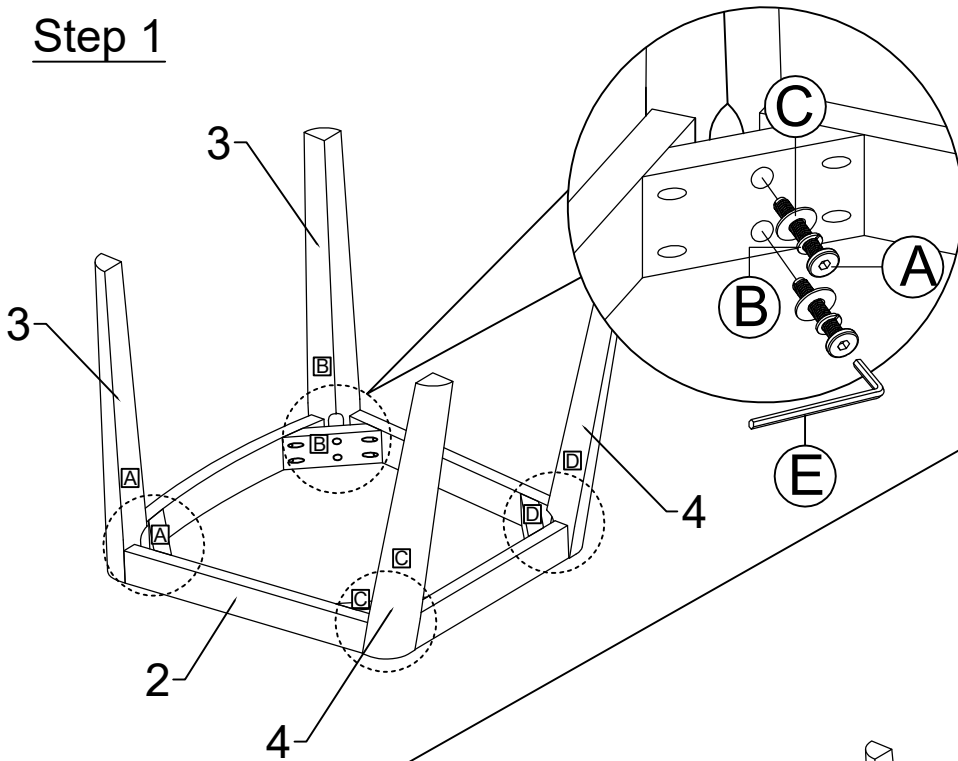

Step 2

