

Step:1

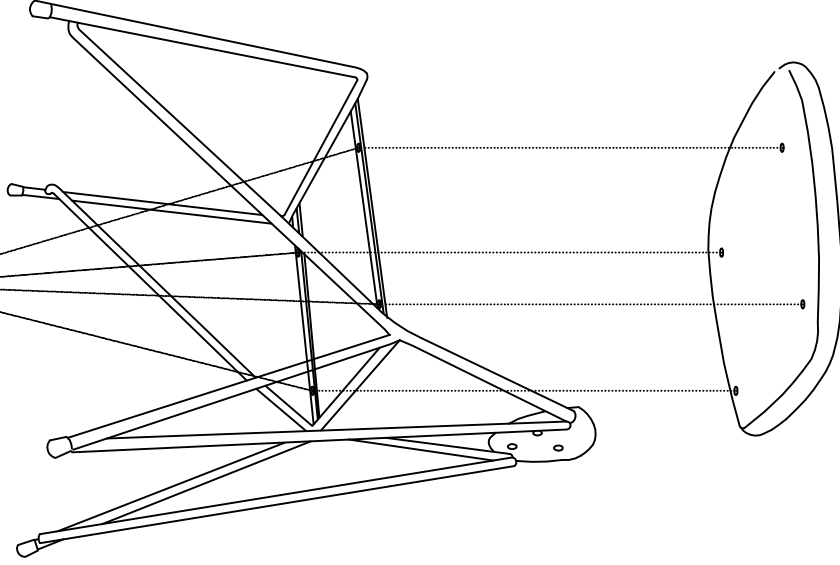

Step:2

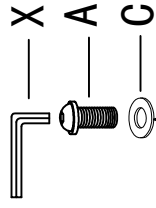
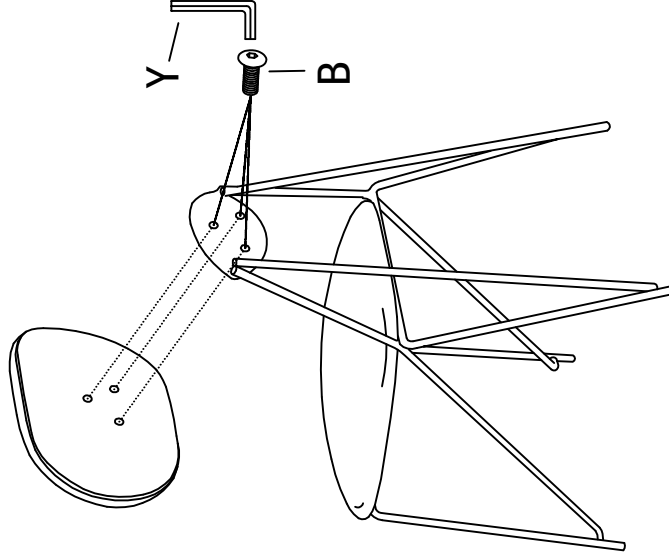

A		x4
B		x3
C		x4

Finish

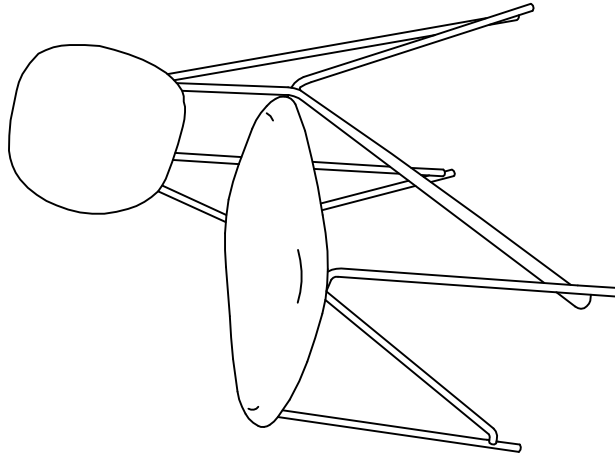

FDC7020

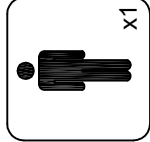

x1

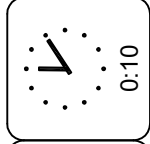

0:10

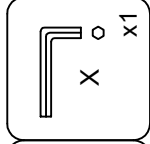

X

x1

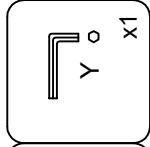

Y

x1