













①	x1	②	x1	③	x4	A	x1	B	x1	C	x2	D	x8
													
E	x8	F	x8	G	x1	H	x1	I	x4	J	x4		
 M6x35mm								 M6x14mm					

1



2

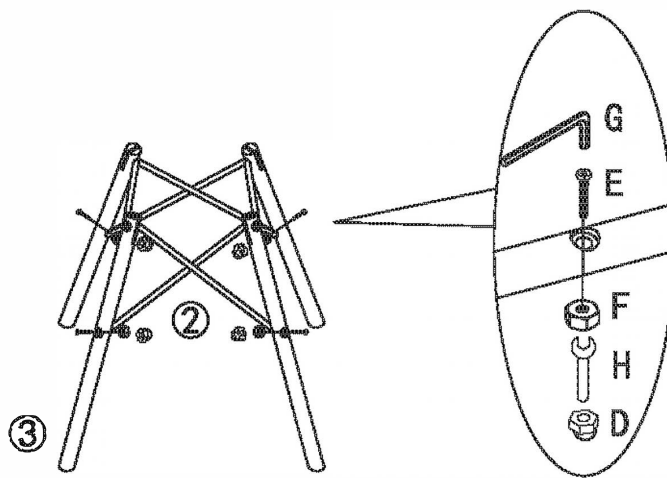
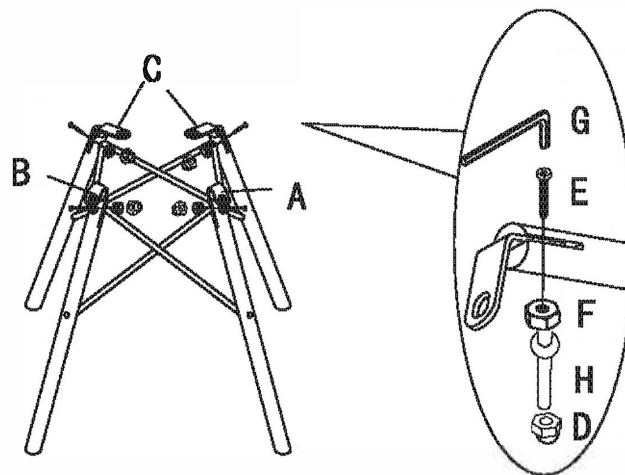

3

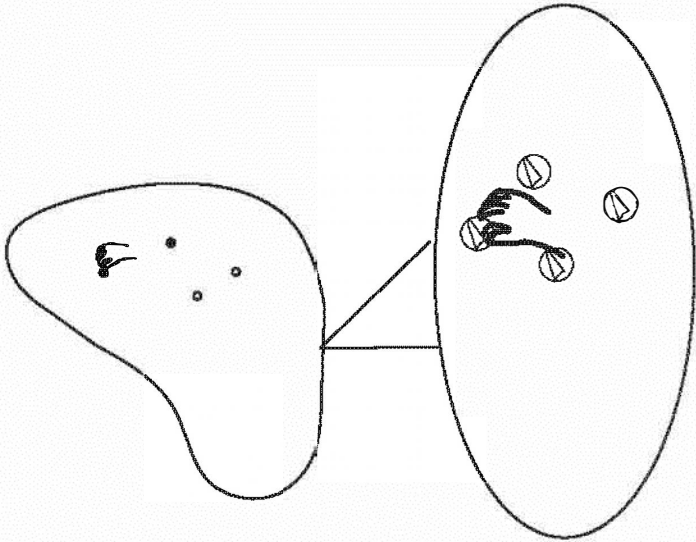

Only remove the felt

5



4

