

COLLECTION
2 0 1 9



de Buyer 
DEPUIS 1830

Chaque recette a son secret*

de Buyer 
MADE IN FRANCE

de Buyer





Every recipe holds a secret

Since 1830, we have been perpetuating ancestral production practices handed down through generations, and we nurture values such as humility, respect and fairness, which we season with a pinch of innovation. Like the Chefs, we carefully measure out these ingredients until we achieve the perfect blend.

Prepare your taste buds: in this new catalogue, we reveal some of our biggest secrets.

Feast your eyes and enjoy!

Thank you for your ongoing loyalty.

Yours sincerely,
Claude Haumesser

MICHEL ROTH INTERVIEW



Michel Roth is one of the most accomplished chefs in the world, having been awarded some of the most prestigious titles in French gastronomy: in 1985 he won the Pierre Taittinger International Culinary Prize, before receiving the Bocuse d'Or and Meilleur Ouvrier de France titles in 1991. Michel Roth represents the epitome of haute cuisine and excellence. Originally from the Grand Est, a region of France which he holds particularly dear, Roth shares strong values with DE BUYER.

This is why he agreed to become our ambassador. A deeply humble and incredibly kind individual, in this interview he shares with us the secrets of an exceptional career.

How did you discover your passion for cooking?

From a very early age I was often in the kitchen with my mother and grandmother, they were the ones who taught me my first recipes. It was my father who saw the beginnings of my passion and said to me one day, "You will be a chef." I began an apprenticeship at 15, working for a friend of my father's. It was very hard in the beginning because I didn't really have any concept of how things worked, I didn't know the hours of the job... I immediately had to get used to such constraints. I lost my father a few months later and my master somewhat took me under his wing, which is not to say he went any easier on me! Over time I started to enjoy the job more and I began to take an interest in working with the products: making vinaigrettes, preparing trout with almonds, and so on.

What was your most important encounter?

My apprenticeship master to begin with. He was the one who told me, "You need to get moving and go to the capital." It was with his help and some audacity that I was lucky enough to join Guy Legay's team at the Ritz, which was the other important encounter at the start of my career. He encouraged me to enter competitions. He had confidence in me. That wasn't always easy day after day, because you

had to be good.

What advice would you give to young people looking to work in cuisine today?

The beginning of the career is very important and stays with you forever. I never stop thinking about it. In my view it was those first years that were the most important. They mould you. Even if they are difficult at times, they form the foundations. You learn what you need to know little by little. Passion, meanwhile, is something which surfaces and then grows as the years go by.

If I had to give one piece of advice, it would be to have patience. Don't cut corners. Cooking is a job which requires a certain level of experience, and you need things to mature before the finest notes can emerge. Always be ready to listen, take a step back, enjoy the moment and savour it before turning a corner.

You won a number of different competitions. What did you take away from that?

I won several competitions, more or less within the same year. I don't like focus on those kinds of awards but I do believe that they help you to find new ways to look at things, new techniques, new products.

Those competitions lent me recognition in the field. That

opened the door to the big leagues. I received a lot of invitations, particularly to go abroad, but my attachment to my family and Lorraine meant that I refused. I had never experienced any of that before the competitions.

It's nice to win a competition, but you shouldn't forget your responsibilities. This is a long-term commitment where you shouldn't get carried away; it embodies the values of respect, work, and excellence. You have a duty to stay on top of your game.

It's said that people from Lorraine are tough but demanding in their work. What do you think?

I see it more as reserved, discreet, cold even, that much is true. There are a lot of talented young people in Lorraine but they don't try hard enough to stand out. These are sincere, hard-working people. I don't know if it's only in Lorraine that you find people like that. When I was an apprentice, I took every opportunity to go home and see my family in Lorraine. That's why I never wanted to go work abroad, because I'm so attached to my region. I also return regularly to the places I trained.

Every recipe has a secret, what's yours?

My cooking starts first and foremost with the basics, and traditional, seasonal and regional food. Next I create flavours and mixtures, following my instinct in the moment while trying to create something surprising. I like to play with a carefully balanced touch of bitterness, which can introduce an element of surprise. I also like to play with acidity, as it can reveal the flavours. It's often the proper balancing of these tastes that makes all the difference, and that's where the complexity lies. Precision in cooking is also important.

Why did you agree to become our ambassador?

It seemed like a natural fit and I feel very connected to DE BUYER. This company embodies the history of our region, a history of family tradition which is being modernised but which maintains a solid foundation. The people working there act as if they're making pans for themselves. I can see the values I appreciate at DE BUYER: precision, simplicity, respect, work, craftsmanship, and an attachment to the region. There's a level of excellence while maintaining humility. That's rare, and that's what makes the difference.

« I CAN SEE
THE VALUES
I APPRECIATE
AT DE BUYER »



Those values are also what I look for in my teams; everybody is working with a sense of sincerity.

How did you get to know DE BUYER?

I've always known about the brand because it's a brand from my region. I've always held a very positive view of the brand's image, which represents reliable, quality products. This image has developed a great deal over time and it has increasingly turned towards modernity and innovation. I've had the opportunity to use DE BUYER products throughout my career and to see these developments take place through the partnerships you've established with chefs' associations.

We believe that good cuisine needs good chefs and good ingredients, but also good utensils. What do you think?

That's certainly true; if you only knew how many times we've said the same in the kitchen. Half of the work done by a good chef comes down to having good products, products prepared by passionate artisans which give us the chance to make the very best of a recipe. But we can't do that without the proper tools.

Our work in the kitchen requires precision and our equipment is our closest ally, allowing us to express ourselves in a dish with ease, safe in the knowledge that the result will be just perfect!

Michel Roth currently acts as Culinary Advisor and chief executive of the Michelin-starred Bayview restaurant at the Hotel President Wilson in Geneva. He also approves the menu of the 'Terroirs de Lorraine' restaurant in Metz railway station.

You can find recipes that Michel Roth has created especially for us in the STAINLESS STEEL and COPPER sections (pages 43 and 65).



Collection B Bois

MINERAL B Bois *page 8*

CHOC B Bois *page 35*

Mills B Bois *page 84*

Utensils B Bois *page 140*



**New handles
cookware ranges**

MINERAL B PRO *page 14*

CHOC EXTREME *page 28*

AFFINITY *page 44*

MILADY *page 52*

PRIMA MATERA *page 66*

INOCUIVRE *page 72*



**Affinity
new models
*page 44***



**Steel steamcooker
fits on copper and stainless steel cookwares
*page 47***



**Copper st/steel INDUCTION
PRIMA MATERA
with cast iron handles
*page 70***



**3-blini
steel frypan
*Page 19***



**Round pastry mould
nonstick steel
*Page 177***



NEW PRODUCTS



Mills collections de Buyer
pages 84-103

Tritan nozzles
Over 30 models
pages 207-211



Flexible pastry bag
page 220



Expandable frames
new conception
page 186

Expandable tarte rings
height 3 cm

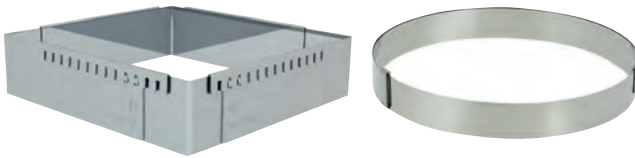

Sultane nozzle
ht 45 mm
page 214



Collection stainless steel tart rings
Perforated rings Ht 20 mm
page 180



Perforated rings Ht 35 mm
pages 180-181



Perforated fluted rings page 182

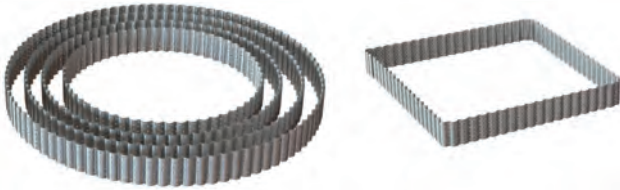

4 supple sheets for
relief decoration
page 195



Mini vegetable slicer KOMI
page 107



Biscuit kit for LE TUBE

page 136





STEEL THAT STANDS THE TEST OF TIME

Steel frying pans are what our grandmothers used to use. These timeless pans are ideal for high-temperature cooking and take a simple and natural approach without any additional coating. We protect and nourish them with beeswax - it is then up to you to season your pan so it can truly flourish.

-8 -
Steel & beeswax
MINERAL B ELEMENT

-17 -
Steel CARBONE
Heavy quality

- 21 -
Blue steel - Extra-strong quality
FORCE BLUE

-23 -
Blue steel - Strong quality
LA LYONNAISE



STEEL PAN B BOIS WITH BEESWAX FINISH

- NATURAL ANTI-OXIDATION PROTECTION
- FAVOURED SEASONING
- IMPROVED NONSTICK QUALITIES

Robust : from 2,5 to 3 mm thick

Riveted handle made of steel and beechwood - Possible oven cooking 10 minutes / 200°C

The beech wood used is a PEFC certified wood coming from sustainably managed forests.

Suitable for all hotplates including INDUCTION

Made in France

'B Bois' products are exclusively sold via physical retailers.



Round frying pan MINERAL B ELEMENT B BOIS

Code	Designation	Øcm	Hcm	Th.mm	Bottom ø cm	Kg
5710.20		20	3,2	2,5	14	1,05
5710.24		24	3,5	2,5	17,5	1,41
5710.26		26	4	3	18,5	1,93
5710.28		28	4	3	21	2,18
5710.32	with 2 handles	32	4,5	3	23	2,66



Round deep country pan MINERAL B ELEMENT B BOIS

Code	Designation	Øcm	Lcm	Hcm	Liters.	Th.mm	ø bottom cm	Kg
5714.24		24	45,6	7,7	2,5	2,5	16,5	1,88



Round crepe pan MINERAL B ELEMENT B BOIS

Code	Designation	Øcm	Lcm	Hcm	Th.mm	Kg
5715.24		24	45,5	1,2	2,5	1,2



STEEL PAN WITH BEESWAX FINISH

- NATURAL ANTI-OXIDATION PROTECTION
- FAVOURED SEASONING
- IMPROVED NONSTICK QUALITIES

Robust : from 2,5 to 3 mm thick

RIVETED STEEL HANDLE

For pan with steel handle:

possible oven cooking 10 minutes / 200°C

Made in France

Suitable for all hotplates including INDUCTION

MINERAL[®]
B ELEMENT

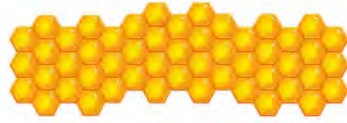

Round frying pan MINERAL B ELEMENT

Code	Designation	Øcm	Hcm	Th.mm	Bottom ø cm	Kg
5610.20		20	3,3	2,5	14	1
5610.24		24	3,5	2,5	17,5	1,39
5610.26		26	4	3	18,5	1,9
5610.28		28	4	3	21	2,15
5610.32	WTH 2 HANDLES	32	4,5	3	23	2,63
5610.36	WTH 2 HANDLES	36	5	3	26	3,53



Round frying pan "GRILL" MINERAL B ELEMENT

Code	Designation	Øcm	Hcm	Th.mm	Bottom ø cm	Kg
5613.26		26	4	2,5	18,5	1,37
5613.32		32	4,5	2,5	23	2,31





Round deep country pan MINERAL B ELEMENT

Code	Designation	Øcm	Hcm	Liters.	Th.mm	Bottom ø cm	Kg
5614.24		24	7,8	2,5	2,5	16,5	1,85
5614.28		28	8,7	4	2,5	19,5	2,47
5614.32	WTH 2 HANDLES	32	9,6	5,5	2,5	22,5	3



Round deep country pan MINERAL B ELEMENT with 2 handles

Code	Designation	Øcm	Hcm	Liters.	Th.mm	Bottom ø cm	Kg
5654.24		24	7,8	2,5	2,5	16,5	1
5654.28		28	8,7	4	2,5	19,5	1,8
5654.32		32	9,6	5,5	2,5	22,5	2,26



Glass lid for wok - Resists up to 200°C

Code	Designation	Øcm	Hcm	Kg
4112.24		24	7,5	0,58
4112.28		28	7,5	0,74
4112.32		32	7,5	1,1
4112.36		36		1,2
4112.40		40	7,5	1,37





Wok MINERAL B ELEMENT



Code	Designation	Øcm	Lcm	Hcm	Th.mm	Kg
5618.24		24	43,7	8	2	1,4
5618.28		28	50,4	9	2	1,76
5618.32	wok - Base ø 8 cm- With 2 handles	32	60,5	9,7	2	2
3329.10	Grid for wok ø 32 cm		34,5			0,14
5618.40	wok - Base ø 11 cm- With 2 handles	40	69	10,4	2	2,75

The wok has forever been the universal Asian kitchen utensil, and it turns out to be ideal for a natural, dietetic cuisine, which needs very little fat and preserves the food's original taste. The 2mm (14 gauge) thickness provides a barrier against increasingly powerful heat sources and thus guarantees an easy-to-digest cuisine.

Wok MINERAL B ELEMENT with 2 handles



Code	Designation	Øcm	Lcm	Hcm	Kg
5619.28		28		9	1,75
5619.32		32		9,7	2
3329.10	Grid for wok ø 32 cm		34,5		0,14

The wok has forever been the universal Asian kitchen utensil, and it turns out to be ideal for a natural, dietetic cuisine, which needs very little fat and preserves the food's original taste. The 2mm (14 gauge) thickness provides a barrier against increasingly powerful heat sources and thus guarantees an easy-to-digest cuisine.

Steel steak frypan, flared edge MINERAL B ELEMENT



Code	Designation	Øcm	Th.mm	Bottom ø cm	Kg
5616.24		24	2,5	18	1,27
5616.28		28	2,5	21,3	1,63

Omelette pan MINERAL B ELEMENT



Code	Designation	Øcm	Hcm	Kg
5611.24		24	3,8	1,35

OMELETTE pan with rounded shape to return easily omelettes and to slide them onto a plate without any problem. Perfect for delicious omelettes, crispy outside and soft inside.



Paella pan MINERAL B ELEMENT with 2 st/steel riveted handles



Code	Designation	Øcm	Hcm	Th.mm	Bottom ø cm	Kg
5652.32	4 p.	32	4,2	3	23	2,5

Round crepe pan MINERAL B ELEMENT



Code	Designation	Øcm	Lcm	Hcm	Th.mm	Bottom ø cm	Kg
5615.24		24	45,5	1,2	2,5	21	1,13
5615.26		26	47,8	1,3	2,5	22,5	1,33
5615.30		30	54,1	1,5	2,5	25,5	1,78

Blinis pan MINERAL B ELEMENT



Code	Designation	Øcm	Lcm	Hcm	Th.mm	Bottom ø cm	Kg	PU
5612.12		12	24,1	1,8	2,5	9,5	0,43	5

3-blinis pan MINERAL B ELEMENT



Code	Designation	Øcm	Th.mm	Kg
5612.03	3 blinis ø 10 cm	27	2	1,11



Pan for Poffertjes and mini-blinis MINERAL B ELEMENT



Code	Designation	Øcm	Lcm	Kg
5612.16		27	47,8	1,1

The Poffertjes pan to cook the famous Dutch mini-pancakes or also mini- blinis. 16 Poffertjes ø 4 cm

Rectangular grill pan with 2 st/steel riveted handles



Rectangular pan PLANCHA, 2 aluminium riveted handles



Code	Designation	Lcm	Wcm	Hcm	Kg
5640.02		38	26	2,5	2,49

Born of the famous healthy and dietetic cooking method, the "plancha" is really practical to cook meat thanks to its wide area. Suitable on all heat sources and hot coals.

Code	Designation	Lcm	Wcm	Hcm	Th.mm	Kg
5640.01		38	26	2,5	2,5	2,21

This "Plancha" pan is used to grill meat without fat content. It is also perfect to cook scallop flesh, shrimps, fish, vegetables..The strong straight aluminium handles are firmly riveted. All heat sources including induction, oven cooking and hotcoals.

Oval roasting-pan with 2 st/steel riveted handles



Code	Designation	Lcm	Wcm	Hcm	Th.mm	Bottom ø cm	Kg
5651.36		36	24	4,8	2,5	21	2,26

Round frypan MINERAL B ELEMENT PRO with cast st/steel handle

new
2019

Code	Designation	Øcm	Hcm	Th.mm	Bottom ø cm	Kg
5680.20		20	3,3	2,5	14	1,09
5680.24		24	3,5	2,5	17,5	1,44
5680.28		28	4	3	21	2,17
5680.32	With 2 handles	32	4,5	3	23	2,9



MINERAL B ELEMENT STEEL PAN WITH BEESWAX FINISH
riveted cast stainless steel handle
Robust : from 2,5 to 3 mm thick. Undistortable.
Suitable for all hotplates including INDUCTION and oven cooking



FRENCH COLLECTION B ELEMENT

Iron frypan - Beewax protective finish
 All heat sources including induction
 Riveted cast stainless steel handles FRENCH COLLECTION
 inspired by Parisian monuments
 Made in France

FOR ORIGINAL BUFFET PRESENTATION OR SERVICE ON TABLE



Round steel frypan FRENCH COLLECTION B ELEMENT

Code	Designation	Øcm	Hcm	Th.mm	Bottom ø cm	Kg
5670.20		20	3,3	2,5	14	1,1
5670.24		24	3,9	2,5	17,5	1,4
5670.28		28	4	3	21	2,2



The French Collection - Celebrated landmarks bring memories to life every time you use your cookware 'made in France' The handles are inspired by the Parisian Tower and bring design along with ergonomomy.

Round steel blini pan FRENCH COLLECTION B ELEMENT

Code	Designation	Øcm	Hcm	Th.mm	Bottom ø cm	Kg
5670.12		12	2	2	9,5	0,5



The French Collection - Celebrated landmarks bring memories to life every time you use your cookware 'made in France' The handles are inspired by the Parisian Tower and bring design along with ergonomomy.

**MINERAL B ELEMENT STEEL COOKWARE - BEESWAX FINISH
REMOVABLE LINE**

Removable Soft Touch comfortable and ergonomic handle
All heat sources + induction



Steel frypan MINERAL B ELEMENT, without handle

Steel sauté pan MINERAL B ELEMENT, without handle



Code	Designation	Øcm	Th.mm	Bottom ø cm	Kg
5630.20		20	2,5	14	0,86
5630.24		24	2,5	17,5	1,23
5630.28		28	3	21	1,93

Code	Designation	Øcm	Hcm	Liters.	Th.mm	Bottom ø cm	Kg
5634.24		24	7,8	2,5	2,5	16,5	1,72

Steel crepe pan MINERAL B ELEMENT, without handle



Code	Designation	Øcm	Hcm	Th.mm	Bottom ø cm	Kg
5635.26		26	1,3	2,5	22,5	1,24

Removable "Soft Touch" handle



Code	Designation	Kg
8359.00	Black	0,12
8359.20	Green	0,12
8359.30	Orange	0,12
8359.40	Red	0,12

This handle is suitable for the 3 removable cookware ranges :
 - Steel MINERAL B ELEMENT
 - Stainless steel TWISTY
 - Nonstick aluminium CHOC EXTREME

STEEL pan - HEAVY QUALITY

2,5 to 3 mm thick for professional strong heat sources
 Perfect heat conduction
 Extra-strong handle
 For pan with steel handle:
 possible oven cooking 10 minutes / 200°C
 Made in France

Perfect for searing, frying, browning

ACIER
CARBONE
 STEEL



Round "lyonnaise" frypan - Heavy quality steel



Code	Designation	Øcm	Lcm	Hcm	Th.mm	Bottom ø cm	Kg	PU
5110.18		18	35,1	3	2,5	12	0,89	3
5110.20		20	36,8	3,2	2,5	14	1,03	3
5110.22		22	42	4	2,5	15,5	1,24	3
5110.24		24	44	3,5	2,5	17,5	1,31	3
5110.26		26	48,5	4	3	18,5	1,93	3
5110.28		28	50,5	4	3	20	2,1	3
5110.30		30	54	4,2	3	21,5	2,35	3
5110.32	With 2 handles	32	60	4,5	3	23	2,71	3
5110.36	With 2 handles	34	69,5	4,5	3	26	3,5	3
5110.40	With 2 handles	38	73	5,3	3	30	4,11	3
5110.50	With 2 handles	48	91	5,7	3	41	6,13	1

The "lyonnaise" profile pan has a high flared and curved skirt. This very distinctive shape, with no sharp angles, enables the food to slide easily from the frying pan onto a plate or dish. The strip steel handle is firmly riveted.

All heat sources.
 Possible oven cooking : 10 minutes at 200°C.

Round frying pan - Stainless steel cold handle

Code	Designation	Øcm	Lcm	Hcm	Th.mm	Bottom ø cm	Kg	PU
5130.20		20	36,6	3,2	2,5	14	1	3
5130.24		24	43,7	3,5	2,5	17,5	1,39	3
5130.28		28	51	4	3	20	2,12	3
5130.32	With 2 handles	32	59,6	4,5	3	23	2,71	3
5130.36	With 2 handles	36	63,9	4,5	3	26	3,2	3
5130.40	With 2 handles	40	68	5,3	3	30	3,4	3



Ergonomic functional stainless tube handle, guaranteed not to heat up and firmly riveted. All hotplates including INDUCTION. Suitable for oven cooking. The "lyonnaise" profile pan has a high flared and curved skirt. This very distinctive shape, with no sharp angles, enables the food to slide easily from the frying pan onto a plate or dish.

Fish frypan - Heavy quality steel

Code	Designation	Lcm	Wcm	Hcm	Th.mm	Bottom ø cm	Kg	PU
5111.32	Oval - total L : 55,5 cm	32	22,5	4	2,5	19	1,93	3
5111.36	Oval - total L : 60 cm	36	26	4	2,5	21	2,3	3
5111.40	Oval - total L : 69,5 cm	40	28	5	3	23	3,32	3
5550.38	Rectangular - total L 50,7 x 39 cm	38	25,5	4,5	3		3,2	3



Oval and oblong frying pans are the ideal shape for cooking whole fish. Note: the standard model has the handle riveted lengthways.

Oval fish frying pan - handle on the short axis

Code	Designation	Lcm	Wcm	Hcm	Th.mm	Bottom ø cm	Kg	PU
5131.36	total L.50,3 cm	36	26	4,6	2,5	21	2,39	3



Handle is riveted on the short axis for "salamander special" model. All hotplates including INDUCTION

Pancake pans - Heavy quality steel

Code	Designation	Øcm	Lcm	Hcm	Th.mm	Perso	Kg	PU
5120.18	2,5 mm th	18	36,2	1,1	2,5	15	0,71	5
5120.20	2,5 mm th	20	38,4	1,1	2,5	17	0,83	5
5120.22	2,5 mm th	22	42,2	1,3	2,5	19	1,02	5
5120.24	2,5 mm th	24	44,2	1,3	2,5	21	1,14	5
5120.26	2,5 mm th	26	50,2	1,3	2,5	22,5	1,37	5
GIANT CREPE PAN								
5120.30	2,5 mm th	30	54,2	1,7	2,5	25,5	1,79	5



Steel plate is the ideal metal for making crispy, tasty crepes. The low skirt of the frying pan allows crepes to be easily flipped and turned. The handle is welded.

Steel blinis pan - Heavy quality steel

new
2019



Code	Designation	Øcm	Lcm	Wcm	Hcm	Th.mm	Perso	Kg	PU
5140.12	Blinis pan - 2,5 mm th	12	24	12,2	2	2,5	9,5	0,41	10
5141.03	3 blinis ø 10 cm	2019	27	48	1,2	2		1,11	3

These frying pans allow you to make the well known Russian specialty blinis as well as fritters and pancakes.

Round frypan, 2 handles - Heavy quality steel



Code	Designation	Øcm	Hcm	Th.mm	Bottom ø cm	Kg	PU
5113.24	2,5 mm th	24	2,5	2,5	17,5	1,2	3
5113.28	3 mm th	28	3	3	20	1,9	3
5113.32	3 mm th	32	3	3	23	2,4	3
5113.36	3 mm th	36	3	3	26	3	3
5113.40	3 mm th	40	5	3	30	3,78	3
5113.50	3 mm th	50	5	3	41	5,82	1

This extra-thick professional frying pan has two firmly welded handles. It has many different uses and proves ideal for paella because of its highly-flared shape, allowing liquid to evaporate quickly (boiling down).

Its heavy-gauge thickness allows food to simmer.

WOK made of iron steel - Special induction cooker



Code	Designation	Øcm	Lcm	Hcm	Th.mm	Kg	PU
5114.35	Polished finishing	35	60,5	8,5	1,5	1,46	3

Typical Asian rounded form adapted to the wok induction cooker. Enables to seal and cook food with little fat for a dietetic and natural Asian cuisine. Optimized weight of the wok to cook effortless. Thanks to the thickness of 15/10° the wok is both solid and light to handle. Riveted steel handle. Guaranteed without coating.

Stainless steel stand for hemispherical wok



Code	Designation	Øcm	Hcm	Th.mm
3122.00		24	3,65	1

Suitable for rounded woks 3122.90 and 5114.35. Enables to use these woks on standard flat induction hotplates. Thanks of the special form with its handle support, the wok is steady on the plate.

Round "Grill" frypan with riveted steel handle



Rectangular grill pan



Code	Designation	Øcm	Lcm	Hcm	Th.mm	Bottom ø cm	Kg	PU
5530.26		26	48	4,3	2,5	18,5	1,42	3
5530.30		30	54	4,5	2,5	21,5	1,74	3
5530.32		32	56	4,5	2,5	23	2,31	3

Ideal for searing meats using hardly any fat. The steel pan reaches high temperatures, caramelizing the meat juices to give your grilled meats flawless flavour. The ribbed base marks the meat and reduces the contact

area between pan and meat. The high side helps prevent from spatters. The thickness of the pan together with the ribbed base prevent shape loss.

Code	Designation	Lcm	Wcm	Th.mm	Kg	PU
5540.38		38	26	2,5	2,52	3

It is the perfect product for healthy cooking. Without fat, you will obtain really tender and grilled meat.



Force Blue



BLUE STEEL - EXTRA-STRONG quality

2 mm thick for professional medium heat sources
 Perfect heat conduction
 Extra-strong handles
 For pan with steel handle:
 possible oven cooking 10 minutes / 200°C
 All heat sources (induction at moderate T°)
 Made in France

Perfect for SEARING, FRYING, BROWNING



Frying pan, blue steel

Code	Designation	Øcm	Lcm	Hcm	Th.mm	Kg	PU
5300.20		20	37	4,2	2	0,95	6
5300.24		24	43,5	4,5	2	1,26	6
5300.28		28	50	5	2	1,66	6
5300.32		32	56	5,5	2	2,1	3
5300.36		36	67	6	2	2,57	3



This "lyonnaise" profile pan made from 2mm (14 gauge) blue steel plate gives very good heat spread. It has a high flared and curved skirt. This very distinctive shape, with no sharp angles, enables the food to slide easily from the frying pan onto a plate or dish. The strip steel handle is firmly riveted.

Blue steel blinis pan

Code	Designation	Øcm	Lcm	Hcm	Th.mm	Kg	PU
5340.12		12	24	2	2	0,33	20



These frying pans allow you to make the well known Russian specialty blinis as well as fritters and pancakes. The handle is riveted.

Pancake pan, blue steel



Code	Designation	Øcm	Lcm	Hcm	Th.mm	Kg	PU
5303.18		18	36	1,5	2	0,58	10
5303.20		20	38	1,5	2	0,69	10
5303.22		22	41,8	1,5	2	0,8	10
5303.24		24	43,5	1,5	2	0,93	10

Blue steel plate is ideal for making crispy, tasty crepes. The low skirt of the frying pan allows crepes to be easily flipped and turned. The handle is welded.

Round "Country" frypan , 2mm blue steel



Code	Designation	Øcm	Lcm	Hcm	Liters.	Th.mm	Kg	PU
5314.20		20	39,5	6	1,7	2	1,19	3
5314.24		24	46,5	6,8	2,5	2	1,58	3
5314.28		28	51,5	7	4	2	1,96	3
5314.32	With 2 handles	32	66,5	8	5,5	2	2,46	3

Between the curved sauté pan and the "Lyonnaise" profile frying pan, this high-sided pan is ideal for all styles of cooking, including frying, searing, grilling. It can be used to prepare large quantities of ingredients and its high sides reduce the amount of juice spat out when cooking meats. Ideal for sautéed potatoes.

La Lyonnaise



BLUE STEEL - STRONG quality

1 to 1,5 mm thick for less powerful heat sources
 Semi-professional and domestic use
 Quick heating time
 Extra-strong handles
 For pan with steel handle:
 possible oven cooking 10 minutes / 200°C

For all heat sources except induction
 Made in France

Round "lyonnaise" frypan, blue steel



Code	Designation	Øcm	Lcm	Hcm	Th.mm	Kg	PU
5020.14	1 mm th	14	26,2	3,3	1	0,25	10
5020.18	1 mm th	18	34,9	3,6	1	0,38	10
5020.20	1 mm th	20	36,9	4	1	0,46	10
5020.24	1 mm th	24	41,2	4,5	1	0,6	10
5020.26	1 mm th	26	46,3	4,5	1	0,69	10
5020.28	1,2 mm th	28	49,3	4,7	1,2	0,93	10
5020.30	1,2 mm th	30	54,4	5	1,2	1,04	10
5020.32	1,2 mm th	32	55,5	5,5	1,2	1,15	5
5020.36	1,5 mm th	36	65,8	6	1,5	1,72	5
5020.40	1,5 mm th	40	69,1	6,5	1,5	2,09	5
5020.45	1,5 mm th	45	83,2	7,5	1,5	2,81	1

The "Lyonnaise" is the traditional "granny-style" frying pan. The lightweight blue steel plate is suitable for low-power heat sources. This "lyonnaise" profile pan has a high flared and curved skirt, with no sharp angles, enabling the food to slide easily from the frying pan onto a plate or dish. The handle is welded.

Paella pan, blue steel



Code	Designation	Øcm	Lcm	Hcm	Th.mm	Kg	PU
5023.20		20			1		3
5023.24		24			1		3
5023.28		28			1		3
5023.34	6 portions - 1,5 mm th	34	42	4,5	1,5	1,43	3
5023.37	8 portions - 1,5 mm th	37	44,4	5	1,5	1,61	3
5023.42	12 portions - 1,5 mm th	42	49,5	5,5	1,5	2,05	3
5023.47	15 portions - 1,5 mm th	47	55	6	1,5	2,64	3
5023.60	25 portions - 1,5 mm th	60	68	6,5	1,5	3,91	1
5023.80	60 portions - 1,5 mm th	80	95,1	9	1,5	8,1	1

The paella dish is not only typical but also has lots of other possible uses: it goes on the hotplate but also in the oven if size allows, and in certain establishments, it goes on the table too. This dish is of medium height and makes it easy to prepare paella or other dishes.

Chrome steel burner tripod



Code	Designation	Lcm	Wcm	Hcm	Kg
0820.00N		59	55	66,5	2,17

The tripod provides a fixed support for the "paella special" gas burner, giving a stable cooking surface when making paellas out in the open. It adapts to burner size up to ø 60/70 cm and bears about 60 kg.

Gas burner, enamelled steel



Code	Designation	Øcm	Lcm	Hcm	Kg
0816.40N	For paella pan 60-100 cm- 11,7 KW	41	69	11,1	2,51
0816.50N	For paella pan 60-100 cm - 14 KW	50	84,2	12	3,19
0816.60N	For paella pan 60-100 cm- 19,25 KW	60	94,7	13	3,78

In accordance with European regulations
 Gas burner delivered without adapter
 Standard model with a 37-millibar pressure
 Indicate with order the country where the burner will be used to adapt it.

This burner has independent and separately controllable flame rings and allows a dish or other receptacle to be heated wherever needed and without over-bulky or costly equipment. It's the ideal complement to the paella dish for alfresco meals or for use in reception rooms where improvised "kitchens" or "buffets" are laid out. The gas burner is suitable for both butane and propane.

Paella pan "Viva España", 2 red handles, steel



Code	Designation	Øcm	Hcm	Th.mm	Kg	PU
5026.24N	1 portion	24	3,5	1	0,4	6
5026.28N	3 portions	28	3,7	1	0,51	6
5026.32N	5 portions	32	4	1	0,68	6
5026.36N	7 portions	36	4	1	0,97	6
5026.40N	9 portions	40	4,4	1	1,28	6
5026.46N	12 portions	46	5	1	1,9	4
5026.50N	14 portions	50	5	1	2,22	4
5026.60N	19 portions	60	5	1	4,09	4
5026.70N	25 portions	70	5	1	7	1
5026.80N	40 portions	80	5,2	1	9,3	1
5026.90N	50 portions - 4 handles	90	6,2	1,5	12	1

From 1.0 to 1.5mm thick (16 to 20 gauge), this paella dish is modeled on the typical Spanish shape, with a relatively low skirt. The hammered bottom gives this item a distinctive look.

Chestnut pans, blue steel



Code	Designation	Øcm	Lcm	Hcm	Th.mm	Kg	PU
5290.28	1 mm th	28	49,5	3,7	1	0,7	10
5291.28	Handle 70 cm - 1 mm th	28	95	3,7	1	1,24	5

The chestnut pan with holes in the bottom is a traditional utensil, always made out of steel plate for ruggedness. This design of chestnut pan is exclusively for use on hot coals.



Chestnut pan - ALL HEAT SOURCES -



Code	Designation	Øcm	Lcm	Hcm	Th.mm	Kg	PU
5293.28		28	48,7	4,7	1,1	0,91	10

Chestnut pan with side ventilation for improved heat circulation: an exclusive process allows this chestnut pan to be used on all types of hotplates, including gas and induction. The grooved bottom allows the chestnuts to roast better.

Rounded steel deep-fryer without basket



Code	Designation	Øcm	Lcm	Hcm	Liters.	Th.mm	Kg
5050.28		28	33,8	8	4	1,2	1,01
5050.32		32	38,9	9,3	6	1,2	1,29
5050.36		36	39,8	10,5	8,8	1,5	2,25
5050.40		40	42,5	13,1	12,2	1,5	2,86
5050.45		45	45,3	14,5	17,3	1,5	3,42
5050.50		50	50,3	16,4	23,5	1,5	4,35

Steel plate, being a very good spreader of heat, is perfect for the manufacture of deep frying vessels. This is the indispensable "SOS" utensil when the electric fryer breaks down. It's also very useful for other unforeseen uses.

Don't forget to order the corresponding frying basket separately.

Tinned wire basket for ref. 5050



Code	Designation	Øcm	Hcm	Kg
5051.28N (1)		25,3	6,3	0,17
5051.32N (1)		29,5	8,7	0,25
5051.36N (1)		32,6	9,3	0,26
5051.40N (2)		39	12,4	0,5
5051.45N (2)		43	15	0,69
5051.50N (2)		46,5	17	0,74



You can set the basket handles on the raised handles of the deep fryer so the cooking oil drains away perfectly. Make sure the basket is clear of the oil. The basket is close-woven to ensure no food falls through the gaps. Mesh 8x 8 mm.

Box of 10 neoprene handle gloves for thermic protection



Code	Designation	Lcm	Wcm	Hcm	Kg
4636.00		20,5	13	5,5	0,26



OUTSTANDING NON-STICK PANS

Our non-stick ranges are recommended for low-temperature cooking as they cook up dishes with great care without altering food. These pans are thick and have non-hazardous coatings allowing you to cook without using fat nor oil.

De Buyer will even recycle them.

- 28 -

Cast aluminium INDUCTION
CHOC EXTREME

- 32 -

Aluminium CHOC RESTO INDUCTION

- 36 -

Aluminium CHOC

- 38 -

Aluminium CHOC ACCESS



CHOC EXTREME

Cookware made of real pressure cast aluminium
 Improved higher quality non-stick coating
 ULTRA REINFORCED - Guaranteed without PFOA
 EXTREME HARD = longer lifetime
 Undistortable thick magnetic bottom
 All heat sources including induction

For simmering, reheating and cooking delicate dishes



Round non-stick frypan CHOC EXTREME with riveted cast st/steel handle

Code	Designation	Øcm	Lcm	Hcm	Th.mm	Bottom ø cm	Kg
8300.20		20	40	4,5	3	14	0,8
8300.24		24	46,5	4,5	3	16	1,16
8300.28		28	54	4,5	3	18,5	1,45
8300.32	with 2 handles	32	63	4,5	3	22	2,27



CHOC EXTREME is made from pressure cast aluminium and is covered with the highest quality non-stick coating which is consolidated by a PTFE projection. It stands up excellently to deformation, knocks, and sudden changes in temperature. This frying pan is ideal for providing regular cooking conditions as its very thick base cuts out sudden, unwelcome reactions when too much heat is applied. The ergonomic cast st/steel handle is firmly riveted.

Round non-stick saucepan CHOC EXTREME with riveted cast stainless steel handle

Code	Designation	Øcm	Hcm	Th.mm	Bottom ø cm	Kg
8309.00		18	9	1	12	1



Non-stick sauté-pan with riveted cast st/steel handle



Code	Designation	Øcm	Lcm	Hcm	Liters.	Th.mm	Bottom ø cm	Kg
8304.20		20		6,2	1,5	3	12	0,95
8304.24		24	47,2	6	2,5	3	16	1,45
8304.28		28	53,5	6	3,5	3	19,5	1,71

Non-stick coating on a hard stainless backing, abrasion and scrape resistant. This sauté pan is ideal for simmering food. Ergonomic functional cast stainless steel handle firmly riveted. All hotplates including INDUCTION

Round nonstick frypan CHOC EXTREME with tubular stainless steel handle



Code	Designation	Øcm	Hcm	Th.mm	Bottom ø cm	Kg
8310.20		20	4,2	3	12,5	0,8
8310.24		24	4,2	3	16	1,2
8310.28		28	4,6	3	18,5	1,8
8310.32		32	4,6	3	22	2
8310.36	with 2 handles	36	4,6	3	23	2,5

CHOC EXTREME is made from pressure cast aluminium and is covered with the highest quality non-stick coating which is consolidated by a PTFE projection. It stands up excellently to deformation, knocks, and sudden changes in temperature. This frying pan is ideal for providing regular cooking conditions as its

very thick base cuts out sudden, unwelcome reactions when too much heat is applied. The ergonomic st/steel handle is firmly riveted.

Glass lid with stainless steel knob



Code	Designation	Øcm	Kg
3429.16		16	0,29
3429.20		20	0,41
3429.24		24	0,58
3429.28		28	0,74
3429.32		32	1,1
3429.36		36	1,2

These glass lids with stainless steel button fit the CHOC EXTREME range of pans and sauté pans. Suitable for oven cooking.

Stewpan, 2 handles, with glass lid - CHOC EXTREME



Code	Designation	Øcm	Lcm	Hcm	Liters.	Th.mm	Bottom ø cm	Kg
8311.20		20	27	8,5	2,8	3	14,5	1,37
8311.24		24	33,5	9,5	4,7	4	16,5	1,76
8311.28		28	37	10	7	4	18,5	2,45

Suits with its lid for oven cooking.

Wok CHOC EXTREME, with 2 handles

Code	Designation	Øcm	Lcm	Hcm	Th.mm	Bottom ø cm	Kg
8317.00	Wok	32		11	3	18	1,62
3329.10	Grid for wok ø 32 cm		34,5				0,14



The glass lid 3429.32 suits on the wok.

Sauté-pan, 2 handles, without glass lid - CHOC EXTREME

Code	Designation	Øcm	Lcm	Hcm	Th.mm	Bottom ø cm	Kg
8313.20	Sauté-pan without lid ø 20 cm	20	27	6	3	12,5	0,96
8313.24	Sauté-pan without lid ø 24 cm	24	31	6	4	15,5	1,28
8313.28	Sauté-pan without lid ø 28 cm	28	35	6,5	4	19,5	1,74
8313.32	Sauté-pan without lid ø 32 cm	32	40,5	7,5	4	22	2,16
8313.36	Sauté-pan without lid ø 36 cm	36		8,5	4	23	2,75



The two-handed sauté dish allows quick browning of food. It has the same uses as a one-handed sauté pan but turns out to be more practical to handle and takes up less space when stored away or when on the burner.

Box of 10 neoprene pairs of handle gloves for thermic protection

Code	Designation	Lcm	Wcm	Hcm	Kg
4636.10	Small size 7 cm	24	14,5	6	0,36
4636.20	Large size 11 cm	24	14,5	6	0,44

Fits to the handles of stewpan, sauté-pan etc. to handle without any risk of burning

**Flat 'plancha' pan CHOC EXTREME, with 2 integrated handles**

Code	Designation	Lcm	Wcm	Hcm	Bottom ø cm	Kg
8308.01	Rectangular dim. ext. 42,5 x 27 x 6 cm - øbottom18,5 cm While stocks last	33	25	1,7	18,5	1,7





Steel frypan CHOC EXTREME, without handle



Code	Designation	Øcm	Th.mm	Bottom ø cm	Kg
8363.20		20	3	12,5	0,6
8363.24		24	3	16	0,84
8363.28		28	3	18,5	1,23
8363.32		32	3	22	1,96

Steel sauté pan CHOC EXTREME, without handle



Code	Designation	Øcm	Hcm	Liters.	Th.mm	Bottom ø cm	Kg
8362.20		20	6,2	1,5	3	16	0,79
8362.24		24	6	3,5	3	16	1,27
8362.28		28	6	3,5	3	19,5	1,54

Removable "Soft Touch" handle



Code	Designation	Kg
8359.00	Black	0,12
8359.20	Green	0,12
8359.30	Orange	0,12
8359.40	Red	0,12

This handle is suitable for the 3 removable cookware ranges :
 - Steel MINERAL B ELEMENT
 - Stainless steel TWISTY
 - Nonstick aluminium CHOC EXTREME



PROFESSIONAL PANS
MADE OF NON-STICK ULTRA THICK ALUMINIUM
FORGED INDUCTION BOTTOM
HONEYCOMBED & EMBEDDED
 = perfect heat distribution and optimal fit

Improved PTFE 5-LAYER coating without PFOA
 for a better resistance to abrasion and to heat
 Optimum non-stick and slip qualities
 Riveted steel handle: possible oven cooking 10 minutes / 200°C

For simmering, reheating and cooking delicate dishes



Round nonstick frypan CHOC Resto Induction made of thick aluminium

Code	Designation	Øcm	Lcm	Hcm	Th.mm	Bottom ø cm	Kg
8480.20		20	36,7	3	5	12	0,78
8480.24		24	43,5	3,5	5	14	1,03
8480.28		28	50	3,8	5	18	1,31
8480.32		32	55,6	4,5	5	20	1,7
8480.36		36	66	4,7	5	24	2,45



The professional non-stick aluminium frypan CHOC RESTO INDUCTION is covered with a high-quality improved PTFE coating . Therefore, it is resistant to abrasion and to heat. The strip handle is firmly riveted and covered with a heat-resistant epoxy. All hotplates.

Non-stick aluminium frypan CHOC Resto Induction with red handle - HACCP



Code	Designation	Øcm	Lcm	Hcm	Th.mm	ø bottom cm	Kg
Red handle for red meat							
8450.20		20	36,7	3	5	12	0,78
8450.24		24	43,5	3,5	5	14	1,03
8450.28		28	50	3,8	5	18	1,31
8450.32		32	55,6	4,5	5	20	1,7

The traditional non-stick frypan CHOC made of thick aluminium is equipped with a heat resistant coloured cast strip handle. Practical and hygienic, this new system avoids cross contamination (transfer of bacteria from one food to another). You simply cook different foods in different frypans. It is helpful in professional kitchens that must observe strong hygiene regulations.

Non-stick aluminium frypan Choc Recto Induction with green handle -HACCP



Code	Designation	Øcm	Lcm	Hcm	Th.mm	ø bottom cm	Kg
Green handle for vegetables							
8460.20		20	36,7	3	5	12	0,78
8460.24		24	43,5	3,5	5	14	1,03
8460.28		28	50	3,8	5	18	1,31
8460.32		32	55,6	4,5	5	20	1,7

The traditional non-stick frypan CHOC made of thick aluminium is equipped with a heat resistant coloured cast strip handle. Practical and hygienic, this new system avoids cross contamination (transfer of bacteria from one food to another). You simply cook different foods in different frypans. It is helpful in professional kitchens that must observe strong hygiene regulations.

Non-stick aluminium frypan CHOC Resto Induction with yellow handle -HACCP



Code	Designation	Øcm	Lcm	Hcm	Th.mm	ø bottom cm	Kg
Yellow handle for white meat							
8470.20		20	36,7	3	5	12	0,78
8470.24		24	43,5	3,5	5	14	1,03
8470.28		28	50	3,8	5	18	1,31
8470.32		32	55,6	4,7	5	20	1,7

The traditional non-stick frypan CHOC made of thick aluminium is equipped with a heat resistant coloured cast strip handle. Practical and hygienic, this new system avoids cross contamination (transfer of bacteria from one food to another). You simply cook different foods in different frypans. It is helpful in professional kitchens that must observe strong hygiene regulations.

Non-stick aluminium frypan CHOC Resto Induction with blue handle -HACCP



Code	Designation	Øcm	Lcm	Hcm	Th.mm	øbottom cm	Kg
Blue handle for fish							
8440.20		20	36,7	3	5	12	0,78
8440.24		24	43,5	3,5	5	14	1,03
8440.28		28	50	3,8	5	18	1,31
8440.32		32	55,6	4,5	5	20	1,7

The traditional non-stick frypan CHOC made of thick aluminium is equipped with a heat resistant coloured cast strip handle. Practical and hygienic, this new system avoids cross contamination (transfer of bacteria from one food to another). You simply cook different foods in different frypans. It is helpful in professional kitchens that must observe strong hygiene regulations.

Pancake non-stick pan CHOC Resto Induction



Code	Designation	Øcm	Th.mm	Bottom ø cm	Kg
8485.26		26	4	18	0,8
8485.30		30	4	22	1

Fish oval non-stick frypan CHOC Resto Induction



Code	Designation	Lcm	Wcm	Hcm	Th.mm	Bottom ø cm	Kg
8481.36		36	26	4,3	5	18	1,7

This non-stick frying pan is ideal for cooking delicate dishes such as fish. The oval shape of this frying pan enables whole fish to be cooked. Firmly riveted steel handle.

Fish oval non-stick frypan CHOC Resto Induction



Code	Designation	Lcm	Wcm	Hcm	Th.mm	Bottom ø cm	Kg
8481.01	Frypan without lid	36	26	4,3	5	18	1,75
8481.00	Frypan with lid	36	26	4,3	5	18	2,6

This non-stick frying pan is ideal for cooking delicate dishes such as fish. The oval shape of this frying pan enables whole fish to be cooked. Firmly riveted steel handle.





Round nonstick frypan Choc B BOIS Induction



Code	Designation	Øcm	Lcm	Hcm	Th.mm	ø bottom cm	Kg
8780.20		20	36,7	3,2	4	14	0,81
8780.24		24	44	3,7	4	14	1,06
8780.28		28	50	4	4	18	1,34
8780.32		32	57	4,5	4	20	1,73

Strip steel handle with beech wood treated with beeswax for the nonstick pan CHOC B BOIS. Nonstick coating on the whole pan, on inner and outer sides.

Optimum resistance to abrasion + better non-stick and slip qualities.

Suitable for all heat sources including induction. Possible oven cooking 10 minutes / 200°C.

Nonstick pans are ideal for simmering, reheating cooking and cooking delicate dishes.

*B Bois' products are exclusively sold via physical retailers.

**PROFESSIONAL PANS MADE OF THICK ALUMINIUM
NON STICK : high-quality 5-layer PTFE coating**

guaranteed without PFOA Improved resistance to abrasion
Grooved bottom for better heat spreading and cooking
Firmly riveted strip steel handle
All heat sources except induction.
Oven cooking : 200°C during 10 minutes



For simmering, reheating and cooking delicate dishes



Round frypan CHOC



Code	Designation	Øcm	Lcm	Hcm	Th.mm	Kg	PU
8180.20		20	36,7	3	4	0,61	3
8180.24		24	43,5	3,5	4	0,83	3
8180.26		26	48	3,7	4	0,95	3
8180.28		28	50	3,8	4	1,03	3
8180.30		30	54	4,5	4	1,21	3
8180.32		32	55,6	4,5	4	1,31	3
8180.36		36	66	4,7	5	2,03	3
8180.40		40	70	5,3	5	2,36	3

The non-stick frying pan is ideal for re-warming, for readying pre-cooked dishes for serving, and for cooking delicate dishes. This "lyonnaise" profile frying pan has a high flared and curved skirt. This very distinctive shape, with no sharp angles, enables the food to slide easily from the frying pan onto a plate or dish. The strip steel handle is firmly riveted.

CHOC non-stick frying pan - Special handle for oven cooking at high temperatures



Code	Designation	Øcm	Lcm	Hcm	Th.mm	Kg
8090.20		20	36,7	3	4	0,61
8090.24		24	43,5	3,5	4	0,83
8090.28		28	50	3,8	4	1,03
8090.32		32	55,6	4,5	4	1,3
8090.36		36	66	4,7	5	2,03



This version of the CHOC frying pan has been specially designed for cooking at high temperatures in a traditional oven: the firmly riveted strip steel handle in black has a special coating that can

withstand extended periods in the oven. For all stove types, except induction.

Fish frypans CHOC



Code	Designation	Lcm	Wcm	Hcm	Th.mm	Kg	PU
8181.36	Oval fish frypan	36	26	4,3	5	1,61	3
8181.40	Oval fish frypan	40	28	4,5	5	1,95	3
8184.38	Rectangular frypan	38	26	4,2	5	1,87	3

Oval and oblong frying pans are the ideal shape for cooking whole fish. The non-stick frying pan is ideal for cooking delicate dishes, such as fish. The strip steel handle is firmly riveted.

Fish oval non-stick frypan CHOC - Special handle for oven cooking at high temperatures



Code	Designation	Lcm	Wcm	Hcm	Th.mm	Kg
8091.36	"salamander special" model.	36	26	4,3	5	1,61

This non-stick frying pan is ideal for cooking delicate dishes such as fish. The oval shape of this frying pan enables whole fish to be cooked. Firmly riveted steel handle.

Paella pan CHOC



Code	Designation	Øcm	Lcm	Hcm	Th.mm	Kg
8183.36	2 handles	36	47	4,7	5	1,84
8183.40	2 handles	40	51	5,2	5	2,16

This paella dish has many possible uses: it goes on the hotplate but also in the oven if size allows, and in certain establishments on the table too. This dish has a relatively high skirt and makes it easy to prepare paella or other dishes.

Blinis pan CHOC



Code	Designation	Øcm	Lcm	Hcm	Th.mm	Kg	PU
8140.12		12	24,2	1,5	3,3	0,2	10
8140.14		14	26	1,7	4	0,24	10

These frying pans allow you to make the well known Russian specialty, blinis as well as fritters and pancakes. The strip steel handle is riveted.

Pancake pan CHOC



Code	Designation	Øcm	Lcm	Hcm	Th.mm	Kg	PU
8185.22		22	42	1,5	3,3	0,6	10
8185.26		26	45	1,5	3,3	0,7	10
8185.30		30	54	1,5	3,3	0,8	5

The non-stick crepe pan has a low skirt and optimum slip qualities, allowing crepes to be easily turned and to slide onto a plate without any problem. Firmly riveted strip steel handle.

Spatula for non-stick frypans



Code	Designation	Lcm	Wcm	Kg	PU
4813.01N		28	6,5	0,03	5

This flexible nylon spatula has rounded edges and is recommended for use with CHOC cooking utensils as it avoids damaging their non-stick coating. Heat resistant.

Non-stick conical sauté-pan CHOC



Code	Designation	Øcm	Lcm	Hcm	Th.mm	Kg
8188.20		20	35,8	6,5	4	0,9
8188.24		24	43	6,5	4	1,2
8188.28		28	49,5	7,1	4	1,27
8188.32		32	55,6	7,8	5	1,97

The curved sauté pan is ideal for boiling down foods as its small base enables rapid heating and its large rim diameter allows a high degree of evaporation while stirring the contents. Pouring rim and rounded angles.

Non-stick wok CHOC with handle - ø 32 cm



Code	Designation	Øcm	Lcm	Hcm	Liters.	Th.mm	Kg
8187.32		32	62,5	9	3,5	4	1,3

It is the necessary utensil for an healthy and fast cooking. Its form will ensure a good heat allocation but overall it will ensure the food's original qualities conservation .

Roasting pan, 2 handles - Thick aluminium



Code	Designation	Lcm	Wcm	Hcm	Th.mm	Kg
7664.30	Total length : 36 cm	30	30	6,5	4	1,9
7664.35	Total length : 41 cm	35	25	6,5	4	1,81
7664.40	Total length : 46 cm	40	32	8	4	2,6
7664.50	Total length : 56 cm	50	40	8	4	6,61

Useful for cooking, browning meat or serving.

ALUMINIUM NON-STICK FRYPAN
SEMI-PROFESSIONAL

High quality PTFE non-stick coating
Firmly riveted strip steel handle
All heat sources except induction.
Oven cooking : 200°C during 10 minutes

For simmering, reheating and cooking delicate dishes

Choc
ACCESS



Round frypan CHOC Access



Code	Designation	Øcm	Lcm	Hcm	Th.mm	Kg	PU
8030.20		20	37	3	3	0,47	3
8030.24		24	43,3	3,5	3,3	0,73	3
8030.28		28	49,5	4	3,3	0,93	3
8030.32		32	55,5	4,5	3,3	1,17	3
8030.36		36	65	4,5	4	1,66	3
8030.40		40	70	5,2	4	2,05	3

The non-stick CHOC Access frying pan enables rapid heating; it has a quality CHOC PTFE coating, thus ensuring optimum non-stick and slip qualities. It benefits from all the advantages of the

"lyonnaise" profile. Its handle is firmly riveted.

NON STICK PROFESSIONAL CHOC FRYPAN
THICK GAUGE ALUMINIUM
Multi-coated PTFE covering

Riveted extra-strong handle with coloured epoxy coating :

- Food safety
- Keeps each food taste separate

Riveted steel handle: possible oven cooking 10 minutes / 200°C



Round non-stick aluminium frypan CHOC with red handle



Code	Designation	Øcm	Hcm	Th.mm	Kg	PU
Red handle for red meat						
8050.20		20	3	4	0,6	3
8050.24		24	3,5	4	0,9	3
8050.28		28	4	4	1,1	3
8050.32		32	4,5	4	1,6	3

The traditional non-stick frypan CHOC made of thick aluminium is equipped with a heat resistant coloured cast strip handle. Practical and hygienic, this new system avoids cross contamination (transfer of bacteria from one food to another). You simply cook

different foods in different frypans. It is helpful in professional kitchens that must observe strong hygiene regulations.

Round non-stick aluminium frypan CHOC with yellow handle



Code	Designation	Øcm	Hcm	Th.mm	Kg	PU
Yellow handle for white meat						
8070.20		20	3	4	0,6	3
8070.24		24	3,5	4	0,9	3
8070.28		28	4	4	1,1	3
8070.32		32	4,5	4	1,6	3

The traditional non-stick frypan CHOC made of thick aluminium is equipped with a heat resistant coloured cast strip handle. Practical and hygienic, this new system avoids cross contamination (transfer of bacteria from one food to another). You simply cook

different foods in different frypans. It is helpful in professional kitchens that must observe strong hygiene regulations.

Round non-stick aluminium frypan CHOC with blue handle



Code	Designation	Øcm	Hcm	Th.mm	Kg	PU
Blue handle for fish						
8040.20		20	3	4	0,6	3
8040.24		24	3,5	4	0,9	3
8040.28		28	4	4	1,1	3
8040.32		32	4,5	4	1,6	3

The traditional non-stick frypan CHOC made of thick aluminium is equipped with a heat resistant coloured cast strip handle. Practical and hygienic, this new system avoids cross contamination (transfer of bacteria from one food to another). You simply cook

different foods in different frypans. It is helpful in professional kitchens that must observe strong hygiene regulations.

Round non-stick aluminium frypan CHOC with green handle



Code	Designation	Øcm	Hcm	Th.mm	Kg	PU
Green handle for vegetables						
8060.20		20	3	4	0,6	3
8060.24		24	3,5	4	0,9	3
8060.28		28	4	4	1,1	3
8060.32		32	4,5	4	1,6	3

The traditional non-stick frypan CHOC made of thick aluminium is equipped with a heat resistant coloured cast strip handle. Practical and hygienic, this new system avoids cross contamination (transfer of bacteria from one food to another). You simply cook

different foods in different frypans. It is helpful in professional kitchens that must observe strong hygiene regulations.





STAINLESS STEEL: A CLASSIC

st/steel cookware

Our stainless-steel products are must-have utensils for any kitchen. Its safe and durable stainless steel makes it easy to maintain. It's "pure gold". The AFFINITY multi-layer range is worth a special mention: the products heat up quickly and distribute heat beautifully.



- 44 -

Multilayer material
AFFINITY

- 51 -

NOSTALGY

- 52 -

MILADY

- 54 -

Removable line TWISTY

- 56 -

Professional range
PRIM'APPETY





FREE-RANGE CHICKEN WITH THYME CRUMBLE, CEP TARTE FINE, CEPS AND PUMPKIN

by Michel Roth



 4	 90 minutes	★★★ level expert
---	---	---------------------

CHICKEN:

2 free-range supremes of chicken,
40 g of butter,
2 sprigs of thyme,
2 cloves of garlic

CHICKEN JUS:

1 chicken carcass,
1 carrot,
1 white onion,
1 leek

PUMPKIN:

$\frac{1}{4}$ pumpkin,
2 button ceps, 20 g butter

CELERIAC PUREE:

1 celeriac,
50 g butter,
100 g cream,
salt, pepper

THYME CRUMBLE:

30 g flour,
30 g ground almonds,
30 g butter,
2 g fleur de sel, 15 g thyme

CEP DUXELLES:

250 g ceps,
40 g shallots, 10 g butter,
15 g chopped parsley

CEPS CONFITS:

300 g ceps confits,
50 cl grape seed oil,
2 cloves of garlic,
thyme,
salt, pepper

FINISHING

AND DECORATION:

250 g puff pastry
1 tray of astina cress (or chervil)

COOKING THE CHICKEN:

Brown the 2 supremes of chicken in a frying pan on each side until they are a pale golden colour. Add the butter, garlic and thyme and then cook the supremes in the oven for 20 minutes at 180° C. Remove them from oven and leave to rest. Cut them in 2 when you dress the plate.

JUS:

Take the chicken carcass and brown it in a saucepan. Add the vegetables and enough water to cover the carcass. Cook for 30 minutes, remove from heat, strain through a fine sieve and then reduce the resulting liquid for 20 minutes. Keep hot.

PUMPKIN AND WHOLE CEPS:

Peel the pumpkin and cut into half-moon slices. Halve the ceps. Roast the pumpkin slices and ceps in a frying pan with the butter.

Put in the oven for 20 minutes at 170° C and then set aside.

CELERIAC PUREE

Dice the celeriac, rinse, cook and drain. Blend in a food processor to obtain a puree. Add the butter and cream, season to taste and set aside.

THYME CRUMBLE:

Blend all the ingredients to a homogenous paste. Spread the paste out on a sheet of baking paper to a thickness of around 1 cm.

Bake in the oven for 15 minutes at 160° C.

CEP DUXELLES:

Chop the shallots finely and sweat them gently in the butter without colouring them, add the sliced ceps and cook on a low heat for 15 minutes. Chop everything and add the chopped parsley. Check the seasoning.

TARTE FINE WITH CEPS

Roll out the puff pastry until it is quite thin and then cut 4 circles with a diameter of 8 cm and place them on baking paper. Bake in the oven at 180° C for 20 minutes. Slice the confit ceps and arrange them on a sheet of baking paper in the shape of a circle with a diameter of 8 cm. Place the confit cep circles (with the baking paper) in a frying pan and cook until pale golden in colour.

Assemble the dish, starting with the cep confit circles, then top with the cep duxelles using a piping bag and finish with the circles of puff pastry.

Then turn the tartes over carefully.

FINISHING AND DRESSING:

Place the supremes of chicken on a plate and then the cep tarte fine. Make dots with the celeriac purée and arrange the leaves of the astina cress (or chervil).

Add the pumpkin and mushrooms and the thyme crumble.

Finish with the chicken jus and the roasted half-ceps to garnish.

COOKWARE AFFINITY

Innovative heat conductor multilayer stainless steel alloy :

- HOMOGENEOUS COOKING
- PERFECT HEAT DISTRIBUTION IN THE PAN
- SAVING VITAMINES AND ENERGY QUICK HEAT INCREASE

Affinity

Gloss finish

Riveted handles made of cast stainless steel.

One-piece construction - Do not distort.

Thickness from 2,3 to 2,7 mm

Suitable for all heat sources and oven cooking.

Made in France



saucepan



Code	Designation	Øcm	Hcm	Liters.	Th.mm	Bottom ø cm	Kg
WITHOUT LID							
3706.14		14	7	1,2	2,3	12	0,73
3706.16		16	8	1,8	2,3	13	0,95
3706.18		18	9	2,5	2,3	15,6	1,12
3706.20		20	10	3,4	2,3	17	1,38
3706.24		24	13	5,8	2,3	20,5	2,4
3706.01	Set of 3 saucepans ø16/18/20 cm				2,3		3,5
WITH LID							
3746.16		16	8	1,8	2,3	13	0,91
3746.18		18	9	2,5	2,3	15,6	1,32
3746.20		20	10	3,4	2,3	17	1,38

Innovative heat conductor multilayer stainless steel alloy :

- QUICK HEAT INCREASE
- SAVING VITAMINES AND ENERGY
- PERFECT HEAT DISTRIBUTION IN THE PAN
- HOMOGENEOUS COOKING

Suitable for all heat sources and oven cooking.

One-piece construction - Do not distort.

Riveted handles made of cast stainless steel.

Straight sauté-pan



Code	Designation	Øcm	Hcm	Liters.	Th.mm	Bottom ø cm	Kg
3730.16		2019	16	6	1	2,3	0,85
3730.20			20	6,5	1,7	2,3	1,16
3730.24			24	7	3	2,7	1,54
3730.28		2019	28	7,5	4,6	2,7	2

This straight-rimmed sauté-pan is perfect for quickly browning food. Its shape assures that the humidity produced will evaporate quickly and that the juices will caramelize thoroughly.



Rounded sauté-pan with handle



Code	Designation	Øcm	Hcm	Liters.	Th.mm	Bottom ø cm	Kg
3736.20		20	6,5	1,7	2,3	13	0,92
3736.24		24	7	3	2,3	17	1,34

This is the essential tool for boiling and reducing sauces. A base that is small in diameter for prompt heating and a wide rim for proper evaporation of the humidity produced. Thanks to this vessel, you will be able to prepare unsurpassable sauces.

Non-stick frypan



Stainless steel frypan



Code	Designation	Øcm	Lcm	Hcm	Th.mm	Bottom ø cm	Kg
3718.20		20	35,3	3	2,7	17	0,71
3718.24		24	42	3,5	2,7	17	1,1
3718.28		28	48	4	2,7	20	1,35
3718.32		32	55,4	4,5	2,7	23	1,72

This non-stick frying pan is ideal and allows delicate dishes like fish to be prepared with perfection. It is covered with PTFE and has a solid bottom that resists abrasion.

Code	Designation	Øcm	Hcm	Th.mm	Bottom ø cm	Kg
3724.20		20	4	2,7	17	0,69
3724.24		24	4	2,7	17	1,1
3724.28		28	4,5	2,7	20	1,34
3724.32		32	5	2,7	23	1,71

This totally stainless steel Affinity frying pan is ideal for quickly frying and grilling meat, thanks to its ability to rapidly increase in temperature. The quality of stainless steel

used to construct this frying pan qualifies it as a strong ally in the quest to caramelize your meat.

Wok with 2 cast st/steel riveted handles



Code	Designation	Øcm	Lcm	Hcm	Liters.	Th.mm	Bottom ø cm	Kg
3743.32	ø bottom 10 cm	32		12	4	2,7	9,5	1,9
3329.10	Grid for wok ø 32 cm		34,5					0,14
	Glass lid suitable for wok Affinity :							
	Glass lid with stainless steel handle							
3429.32		32						1,1
	Glass lid with bakelite handle							
4112.32		32	7,5					1,1

For all hotplates including induction hobs



Sauté-pan with lid

Rounded sauté pan with 2 st/steel handles and lid



Code	Designation	Øcm	Hcm	Liters.	Th.mm	Bottom ø cm	Kg
3741.20		20	6,3	1,7	2,3		1,15
3741.24		24	7	3	2,7	20,5	1,98
3741.28		28	7,5	4,6	2,7		2

Code	Designation	Øcm	Hcm	Liters.	Bottom ø cm	Kg
3745.28		28	10	4,9	20,5	2,45

This vessel has the same qualities as the straight-rimmed sauté-pan, but its two handles make it even easier to use and equally less cumbersome. It will easily find its place in your kitchen.

Stewpan with lid



Code	Designation	Øcm	Hcm	Liters.	Th.mm	Bottom ø cm	Kg
3742.16		16	9	1,8	2,3	13	1,01
3742.20		20	11	3,4	2,3	17	1,7
3742.24		24	13	5,4	2,3	20,5	2,33
3742.28		28	15	10,4	2,7	24	3,64

Contrary to other kitchenware, this stewpan conserves humidity thanks to its high sides. Therefore, it is suitable for heating large quantities of water, simmering, etc. The Affinity material guarantees a rapid increase in temperature and therefore saves you a significant amount of time.

Stainless steel lid



Code	Designation	Øcm	Th.mm	Kg
3709.09		9	1	0,12
3709.10N		10	1	0,14
3709.12N		12	1	0,18
3709.14N		14	1	0,24
3709.16N		16	1	0,28
3709.18N		18	1	0,33
3709.20N		20	1	0,39
3709.24N		24	1	0,51
3709.28		28	1	0,65

This Affinity lid is made to fit all kitchenware in this range, except round frypans.

Stainless steel steamcooker

new
2019



Code	Designation	Øcm
3675.24		24

Steaming is a quick operation with this stainless steel steamer. Fits to the pan of the stainless steel and copper cookware. Equipped with an handle to remove it easily.
Tip from the chef: to make your vegetables glisten, plunge them into cold water once they are cooked.

Oval stewpan with lid



Code	Designation	Lcm	Wcm	Hcm	Liters.	Th.mm	Kg
3726.30		30	22	13	6,5	2,3	3,6
3708.30	Oval lid alone						

Oval stainless steel fish frypan L. 32 cm - handle on the short axis



Code	Designation	Lcm	Wcm	Hcm	Th.mm	Bottom ø cm	Kg
3725.32	All stainless steel	32	23	4,8	2,7	18	1,35
3719.32	Nonstick st/steel	32	23	4,8	2,7	23	1,36

Stainless steel roasting-pan with 2 riveted cast st/steel handles



Code	Designation	Lcm	Wcm	Hcm	Th.mm	Kg
3727.35		41	27,5	8	2,3	2,3

Multilayer material : st/steel Aluminium St/steel
Brushed st/steel finish
Suitable also for domestic oven.



Mini-stewpan with lid and mini sauté-pan



Code	Designation	Øcm	Lcm	Hcm	Liters.	Th.mm	Bottom ø cm	Kg
Mini stewpan								
3742.09		9	14,5	5	0,3	2,2	7,5	0,35
3742.10		10	17	6	0,45	2,3	8	0,5
3742.12		12	19,5	7	0,75	2,3	10	0,67
Mini sauté-pan without lid								
3740.10		10	17	3,8		2,2	8	0,29

The material from which these mini-stewpan are made allows them to be used on all heat sources. Adapted to today's standards, these mini-stewpans will contribute to the modern and elegant presentation of your dishes. Being made of all stainless steel, they are extremely easy to maintain and can conveniently be kept hot

Mini-saucepan



Code	Designation	Øcm	Lcm	Wcm	Hcm	Liters.	Th.mm	Bottom ø cm	Kg
3706.09		9	18,5	10,2	5	0,28	2,2	7,5	0,27

Mini-frypan ø 10 cm



Code	Designation	Øcm	Lcm	Hcm	Th.mm	Bottom ø cm	Kg
3724.10		10	19	2	2,2	8	0,16

FRENCH COLLECTION

Multilayer stainless steel AFFINITY
 All heat sources including induction
 Riveted cast stainless steel handles FRENCH COLLECTION
 inspired by Parisian monuments

FOR ORIGINAL BUFFET PRESENTATION
 OR SERVICE ON TABLE



FRENCH COLLECTION AFFINITY



The French Collection – Celebrated landmarks bring memories to life every time you use your cookware 'made in France' The handles are inspired by Parisian monuments and bring design along with ergonomomy. As a guarantee of strength, the riveting technique of the cast st/steel handles of the de Buyer French Collection is the same as the assembly of metal parts in the famous French « Iron Lady ».

Code	Designation	Øcm	Hcm	Liters.	Th.mm	Bottom ø cm	Kg
	FRYPAN						
3750.20		20	3		2,7	13,8	0,7
3750.24		24	4		2,7	17	1,1
3750.28		28	4		2,7	20	1,34
	SAUCEPAN						
3751.14		14	7,5	1,2	2,3	12	0,8
3751.16		16	8	1,8	2,3	13	0,95
3751.18		18	9	2,5	2,3	15,6	1,12
3751.20		20	10	3,4	2,3	17	1,38
	CONICAL SAUTE-PAN						
3753.24		24	8	3	2,3	17	1,34
	BLINIS PAN						
3750.12		12			2,2	10	0,25

FRENCH COLLECTION AFFINITY stewpan with lid



Code	Designation	Øcm	Hcm	Liters.	Th.mm	Bottom ø cm	Kg
3752.24		24	13	5,4	2,3	20,5	2,8

The French Collection – Celebrated landmarks bring memories to life every time you use your cookware ‘made in France’ The handles are inspired by Parisian monuments and bring design along with ergonomomy.

FRENCH COLLECTION AFFINITY - lid



Code	Designation	Øcm	Th.mm	Kg
	LID			
3754.14		14	1	0,25
3754.16		16	1	0,27
3754.18		18	1	0,32
3754.20		20	1	0,38
3754.24		24	1	0,51

The French Collection – Celebrated landmarks bring memories to life every time you use your cookware ‘made in France’ The handles are inspired by Parisian monuments and bring design along with ergonomomy.



Nostalg



Stainless steel saucepan NOSTALGY with st/steel lid

Code	Designation	Øcm	Hcm	Liters.	Th.mm	Bottom ø cm	Kg
3430.14		14	7	1,2	0,8	12	0,84
3430.16		16	8	1,6	0,8	14	1,05
3430.18		18	9	2,2	0,8	15,8	1,3
3430.20		20	10	3	0,8	17,8	1,49



Discover the NOSTALGY pans', a new pro quality REINFORCED stainless steel cookware which is assembled with a cast st/steel riveted handle. Saucepans and frypans of the range are equipped with a magnetic bottom which allows a perfect heat spreading on all heat sources

OLD TIME FINISH
ORIGINAL AND ELEGANT PRESENTATION ON THE TABLE AND FOR BUFFET
Made in France

Stainless steel frypan NOSTALGY with riveted cast st/steel handle

Code	Designation	Øcm	Hcm	Liters.	Th.mm	Bottom ø cm	Kg
3432.24		24	4,8	1,2	0,8	17,5	1,32
3432.28		28	5,3	1,8	0,8	21	1,64



Stainless steel stewpan NOSTALGY with lid

Code	Designation	Øcm	Hcm	Liters.	Th.mm	Bottom ø cm	Kg
3433.20		20	10	3	0,8	17,8	1,7
3433.24		24	12	5,4	0,8	19,5	2,29



MILADY de Buyer

STAINLESS STEEL COOKWARE MILADY PRO QUALITY

Ergonomic riveted handle made of cast stainless steel
 = good hand grip without tiredness
 Large thick magnetic bottom
 All heat sources + induction
 Perfect heat spreading on the whole bottom
 Gloss polished
 Made in France



Stainless steel saucepan MILADY with riveted cast st/steel handle



Code	Designation	Øcm	Hcm	Liters.	Th.mm	Bottom ø cm	Kg
3410.14		14	7	1,2	0,8	12	0,64
3410.16		16	8	1,6	0,8	14	0,7
3410.18		18	9	2,2	0,8	15,8	0,89
3410.20		20	10	3	0,8	17,8	1,1
3410.03	Set of 3 saucepans ø 16-18-20 cm						3,15
3410.04	Set of 4 saucepans ø 14-16-18-20 cm				0,8		3,83

Discover the 'Milady de Buyer', a new pro quality stainless steel cookware which is assembled with a new cast st/steel riveted handle. Designed by de Buyer, this handle brings design along with ergonomomy and solidity. Saucepans and frypans of the range are

equipped with a magnetic bottom which allows a perfect heat spreading on all heat sources.

Stainless steel frypan MILADY with riveted cast st/steel handle



Code	Designation	Øcm	Hcm	Liters.	Th.mm	Bottom ø cm	Kg
3412.24		24	4,8	1,2	0,8	17,5	1,24
3412.28		28	5,3	1,8	0,8	21	1,64

Stainless steel sauté-pan MILADY with riveted cast st/steel handle



Code	Designation	Øcm	Hcm	Liters.	Th.mm	Bottom ø cm	Kg
3411.24		24	8	3	0,8	17,7	1,1

Stainless steel stewpan MILADY with glass lid



Code	Designation	Øcm	Hcm	Liters.	Th.mm	Bottom ø cm	Kg
3427.20	Stewpan with glass lid	20	10	3	0,8	17,8	1,7
3427.24	Stewpan with glass lid	24	12	5,4	0,8	19,5	2,19
3427.28	Stewpan with glass lid	28	14	8	0,8	25	2,86

The range MILADY is extending with this elegant stainless steel stewpan. It is equipped with 2 large ergonomic st/steel handles and a glass lid.

Glass lid with stainless steel knob



Code	Designation	Øcm	Kg
3429.14		14	0,24
3429.16		16	0,29
3429.18		18	0,35
3429.20		20	0,41
3429.24		24	0,58
3429.28		28	0,74

These glass lids with stainless steel button fit the MILADY range of pans and sauté pans. Suitable for oven cooking.



Twisty



STAINLESS STEEL COOKWARE TWISTY Removable line

Large thick magnetic bottom INDUCTION
All heat sources + induction
Perfect heat spreading on the whole bottom
Gloss polished
Pouring lips & Rounded edges
Perfect hygiene and easy cleaning



Stainless steel saucepan TWISTY without handle



Code	Designation	Øcm	Hcm	Liters.	Th.mm	Bottom ø cm	Kg
3491.14		14	7	1,2	0,8	12	0,44
3491.16		16	8	1,6	0,8	14	0,53
3491.18		18	9	2,2	0,8	15,8	0,72
3491.20		20	10	3	0,8	17,8	0,85
3491.24		24	12	5,4	0,8	19,5	1,28
3491.28	Use only with both silicone handles	28	14	8	0,8	25	1,95
3491.03	Set of 3 saucepans ø 16-18-20 cm without handles				0,8		2,49
3491.04	Set of 4 saucepans ø 14-16-18-20 cm supplied with an handle & 2 silicone handles - black				0,8		3,11

Stainless steel steamcooker for TWISTY range



Code	Designation	Øcm	Kg
3496.20	Steamcooker alone	20	0,45
3496.24	Steamcooker alone	24	0,66

Steaming is a quick operation with this Twisty steamer. Tip from the chef: to make your vegetables glisten, plunge them into cold water once they are cooked.



Stainless steel sauté-pan TWISTY



Stainless steel frypan TWISTY, without handle



Code	Designation	Øcm	Hcm	Liters.	Th.mm	Bottom ø cm	Kg
3495.24		24	8	3	0,8	17,7	0,98

Code	Designation	Øcm	Hcm	Liters.	Th.mm	Bottom ø cm	Kg
3493.24		24	4,8	1,2	0,8	17,5	0,88
3493.28		28	5,3	1,8	0,8	21	1,22

Removable "Soft Touch" handle



Code	Designation	Kg
8359.00	Black	0,12
8359.20	Green	0,12
8359.30	Orange	0,12
8359.40	Red	0,12

This handle is suitable for the 3 removable cookware ranges :
 - Steel MINERAL B ELEMENT
 - Stainless steel TWISTY
 - Nonstick aluminium CHOC EXTREME

Set of 2 black silicone handles



Code	Designation	Kg
8360.00	black	0,04

Glass lid



All stainless steel lid



Code	Designation	Øcm	Hcm	Kg
4112.14		14	6,3	0,24
4112.16		16	6,3	0,3
4112.18		18	6,3	0,35
4112.20		20	6,8	0,41
4112.24		24	7,5	0,58
4112.28		28	7,5	0,74

Code	Designation	Øcm	Th.mm	Kg
3459.14N		14	0,7	0,14
3459.16N		16	0,8	0,19
3459.18N		18	0,8	0,24
3459.20N		20	0,8	0,28
3459.24N		24	0,8	0,34

While stocks last

Possible oven cooking 200°C max.

The stainless steel domed lid fits all the utensils in the Twisty range (except frypans).

PRIM'APPETY

STAINLESS STEEL COOKWARE PRIM'APPETY PROFESSIONAL Stainless steel - Satin polished

Magnetic sandwich bottom - For all heat sources + INDUCTION
Welded handles - Easy cleaning - Dishwasher safe



Saucepan



Code	Designation	Øcm	Hcm	Liters.	Th.mm	Kg
3501.04	Set of 4 saucepans ø 14-16-18-20 cm				0,8	3,3
3501.12		12	6	0,7	0,8	0,44
3501.14		14	7	1	0,8	0,6
3501.16		16	7,5	1,6	0,8	0,7
3501.18		18	9	2,2	0,8	0,9
3501.20		20	9	3	0,8	1,07
3501.24		24	11	5,4	0,8	1,55
3501.28	with 2 handles	28	13	8	0,8	2,4

Totally stainless steel. Sandwich bottom. Pouring lips. All heat sources including induction. Easy to clean. Satin polished. Welded handles.

Round stainless steel frypan



Code	Designation	Øcm	Hcm	Th.mm	Kg
3504.20		20	5	0,6	1,12
3504.24		24	5	0,6	1,35
3504.28		28	5	0,8	1,45
3504.32	With 2 handles	32	6,5	0,8	2,5



Rounded sauté-pan, st. steel handle, without lid

Sauté-pan, st. steel handle, without lid



Code	Designation	Øcm	Hcm	Th.mm	Kg
3503.16		16	6	0,8	0,65
3503.18		18	6,5	0,8	0,85
3503.20		20	7	0,8	1,1
3503.24		24	8	0,8	1,3
3503.28		28	10	0,8	1,5

Code	Designation	Øcm	Hcm	Th.mm	Kg
3502.20		20	6	0,8	1
3502.24		24	6	0,8	1,2
3502.28		28	6	0,8	1,4

Stewpan without lid

Code	Designation	Øcm	Hcm	Liters.	Th.mm	Kg
3505.20		20	10	3,1	0,8	1,16
3505.24		24	12	5,4	0,8	1,66
3505.28		28	14	8,6	0,8	2,13
3505.32		32	16	13,5	0,8	3,2
3505.36		36	18	18,3	0,8	4
3505.40		40	20	25	1	5,7
3505.45		45	22,5	33	1	7,6
3505.50		50	25	43,4	1	8,9



Totally stainless steel. Thick sandwich bottom. Pouring lips.
Satin polished. Welded handles.
All heat sources including induction. Easy to clean.



High stewpan without lid



Code	Designation	Øcm	Hcm	Liters.	Th.mm	Kg
3506.20		20	13	4	0,8	1,26
3506.24		24	14,5	6,6	0,8	1,8
3506.28		28	18	11,1	0,8	2,3
3506.32		32	20	16,1	0,8	3,8
3506.36		36	22	22,4	0,8	4,5
3506.40		40	25	31,4	1	6
3506.50		50	30	58,9	1	9,2

Stockpot without lid



Code	Designation	Øcm	Hcm	Liters.	Th.mm	Kg
3507.20		20	20	6,25	0,8	1,7
3507.24		24	24	11	0,8	2,1
3507.28		28	28	17	0,8	2,9
3507.32		32	32	25	0,8	4,4
3507.36		36	36	36	0,8	5,1
3507.40		40	40	45	1	6,4
3507.45		45	45	69	1	9
3507.50		50	50	100	1	11

Totally stainless steel. Sandwich bottom. Pouring lips. All heat sources including induction. Easy to clean. Satin polished. Welded handles.

Stainless steel steamcooker PRIM' APPETY

new
2019



Code	Designation	Øcm
3675.24		24

Steaming is a quick operation with this steamer. Suitable for PRIM'APPETY stewpans. Tip from the chef: to make your vegetables glisten, plunge them into cold water once they are cooked.

Lid



Code	Designation	Øcm	Kg
3509.14		14	0,13
3509.16		16	0,16
3509.18		18	0,18
3509.20		20	0,21
3509.24		24	0,3
3509.28		28	0,43
3509.32		32	0,66
3509.36		36	0,8
3509.40		40	0,96
3509.45		45	1,12
3509.50		50	1,8

Suitable for all range products

Stainless steel rounded WOK - Special induction hob



Code	Designation	Øcm	Lcm	Hcm	Th.mm	Kg
3122.36	Flat rim	36	63,5	9,5	1,5	1,3
	Inner pan : polished finish					
	Outer pan : gloss polished finish					

Typical Asian rounded form adapted to the wok induction cooker. Enables to seal and cook food with little fat for a dietetic and natural Asian cuisine. Optimized weight of the wok to cook effortlessly. Thanks to the thickness of 15/10° the wok is both solid

and light. The cold ergonomic riveted handle made of stainless steel allows optimum grip without tiredness.

Stainless steel stand for hemispherical wok



Code	Designation	Øcm	Hcm	Th.mm
3122.00		24	3,65	1

Suitable for rounded woks 3122.90 and 5114.35. Enables to use these woks on standard flat induction hotplates. Thanks of the special form with its handle support, the wok is steady on the plate.

Roasting-pan, 2 fixed handles



Code	Designation	Lcm	Wcm	Hcm	Liters.	Th.mm	Kg
3121.40		40	30	8	9	2	3,62
3121.50		50	40	9	17,5	2	5,6
3121.60		60	50	10	29	2	8,2

These roasting pans are fabricated from stainless steel. This makes them distortion-free, unlike stamped utensils which are more vulnerable at high temperatures.

"Induction" fish kettle



Code	Designation	Lcm	Wcm	Hcm	Th.mm	Kg
3449.62N	"Standard", st. steel handles - L. 60 cm	60	16,5	9,5	0,8	1,92

The fish kettle remains the ideal utensil for cooking whole fish to give a perfect appearance. The internal grid allows you to remove the fish without its breaking. All hotplates, including induction.

Bain-marie without lid



Code	Designation	Øcm	Hcm	Liters.	Th.mm	Kg
3111.12		12	11,5	1,3	1	0,42
3111.14		14	14	2,1	1	0,51
3111.16		16	16	3,2	1	0,73
3111.18		18	18	4,6	1	0,86
3111.20		20	20	6,3	1	1

The bain-marie cooking pot is made from stainless steel. Its shape means it can be placed inside a water container (pan), and it allows milk, chocolate, sauces, etc., to be cooked using the bain-marie process. The lid is sold separately

Food storage canister, without lid



Code	Designation	Øcm	Hcm	Liters.	Th.mm	Kg
3390.14		14	12	1,7	0,8	0,49
3390.16		16	13	2,5	0,8	0,59
3390.20		20	16,5	5	0,8	0,91
3390.24		24	20	8	0,8	1,28
3390.28		28	23	14	0,8	1,72
3390.32		32	27	22	0,8	2,28

This stainless steel canister with cupped handles allows food to be stored in perfect safety. It can be used as a container for warming food using the bain-marie process.

Bain-marie cooker



The bain-marie cooker consists of a hollow stainless steel shell in which water is heated.

It enables you to heat at lukewarm temperatures for melting chocolate or keeping sauces warm.

It has a handle, which makes it easy to use.

Suitable on all heat sources incl. induction hobs.

Code	Designation	Øcm	Hcm	Liters.	Th.mm	Kg
3437.16N	With handle and double st. steel body	16	12,5	1,5	1	0,97

2-level smoker oven for hot and cold smoking - Stainless steel



Food is subjected, over a prolonged period, to smoke which has an antiseptic effect and increases shelf life, at the same time enhancing the taste. Smoking gives food a woody taste. More specifically, you can smoke meat (steak, chops, filet mignon, etc.), poultry (chicken, duck, etc.), charcuterie (essentially ham, bacon, large sausages, small sausages, andouilles [spicy sausages]) and fish (salmon, trout, eel, mackerel, etc.). The principle lies in exposing food to smoke at different temperatures, depending on the desired result.

Code	Designation	Lcm	Wcm	Hcm	Kg
3441.60	large 60 x 40 cm	60	40		
3441.00	small 31 x 31 cm	31	31	20	7,3
Composition :					
Smoking chamber with lid					
3441.93	st/steel grid for smoker 31x31 cm				
3441.91	Oven				
3441.90	Fire pit				
3441.92	Aluminium telescopic and flexible pipe				
	One thermometer				
	500 g. of sawdust				
	2 removable feet				
	Delivered with smoking advice and recipes				
	To be assembled				

Beech sawdust for food smoking



Code	Designation	Kg
4441.01	Bag of 0,5 kg	0,51
4441.15	Bag of 15 kg	15,1

Sterilized and dust free. Guaranteed without chemical. Sawdust compliance with the standards DIN ISO 9001. HB50/1000. Grain size : 0.5 to 1.0mm. Humidity 8 à 12 %.

CUISINE BOX PRO - Silicone box for steam cooking in oven



The De Buyer silicone "Cuisine Box" allows you to steam your food quickly and healthily while conserving their full flavour (vegetables, fish, white meat, fruit) for use in traditional and microwave ovens. Its innovative design optimises cooking and makes it really easy to use.

- Secure locking system
- Safe and easy lifting thanks to the handles
- Spout to drain off cooking juices
- Excellent support thanks to springs

Code	Designation	Lcm	Wcm	Hcm	Liters.	Kg
1988.20		19	12	3,8	0,75	0,17



de Buyer 
MADE IN FRANCE

de Buyer 

THE EXCELLENCE OF COPPER

Copper is a leading material for kitchen use and loved by professionals and keen amateurs as well. It conducts heat quickly and evenly and is perfect for thickening sauces and cooking when particular care is required.

The utensil bodies are made of a colaminated material (90% copper; 10% stainless steel). The copper is hand-polished using traditional methods - its gentle, soothing aura making it the perfect companion for your table.

- 66 -

Copper stainless steel Induction
PRIMA MATERA
cast stainless steel handles

- 70 -

Copper stainless steel Induction
PRIMA MATERA
cast steel handles

- 72 -

Copper stainless steel **INOCUIVRE**
cast stainless steel handles

- 76 -

Copper stainless steel **INOCUIVRE**
cast steel handles

- 78 -

Copper stainless steel **INOCUIVRE**
brass handles





BLUE LOBSTER, COLOURED CAULIFLOWER, LOBSTER COULIS WITH ORANGE AND CARDAMOM

by Michel Roth



LOBSTERS:

4 blue lobsters with their claws,
cooked in a bouillon,
20 g butter,
1 garlic clove,
1 sprig of thyme

COLOURED CAULIFLOWERS:

30 g cauliflower,
30 g Romanesco,
30 g yellow cauliflower,
30 g purple cauliflower

LOBSTER COULIS:

110 g lobster bisque
80 g cream
6 cardamom seeds, juice of one orange

FINISHING AND DECORATION:

1 orange
1 tray of coriander sprouts

LOBSTERS:

Roast the lobster in the butter in a sauté pan with the garlic and thyme for about 3 minutes. Season.

COLOURED CAULIFLOWERS:

Cut small pieces and slices from the different coloured cauliflowers. Blanch them quickly, cool and then drain. Brown them lightly in a frying pan with the lobster. Season with salt and pepper.

LOBSTER COULIS:

Reduce the lobster bisque and add the cream and

orange juice, remove from the heat and allow the cardamom seeds to infuse.

Then pass the sauce through a fine sieve and set aside.

FINISHING AND DRESSING:

Cut the lobster into thick slices and arrange them on a plate. Arrange the slices of coloured cauliflower between each slice of lobster and sprinkle with coriander.

Arrange the remaining small pieces of coloured cauliflower and the zest of the orange over the claw.

Add the lobster coulis to complete the garnish.



INOUCIVRE INDUCTION

- Copper outside 90% = excellent heat diffusion
- Stainless steel inside 10% = matchless hygiene - ease of use
- Ergonomic cast stainless steel riveted handles
- All heat sources including induction
- Made in France



Saucepan with magnetic bottom INDUCTION



Code	Designation	Øcm	Hcm	Liters.	Th.mm	Bottom ø cm	Kg
6206.14		14	7,3	1,2	2	12	1,06
6206.16		16	8,3	1,8	2	13,5	1,37
6206.18		18	9,3	2,5	2	15,5	1,66
6206.20		20	10,5	3,3	2	17	2,06
6206.24		24	12,4	6	2	22	2,75

This saucepan made of copper and stainless steel on the inside enables to enjoy the exceptional degree of conductivity of copper on all types of heat sources, including INDUCTION, thanks to its magnetic bottom. The cast stainless steel ergonomic handle are firmly riveted. The st/steel lid 3709 is suitable for the PRIMA MATERA pans (except frypan).

Sauté pan with magnetic bottom INDUCTION



Code	Designation	Øcm	Hcm	Liters.	Th.mm	Bottom ø cm	Kg
6230.16		16	5,5	1	2	13,5	1,13
6230.20		20	5,8	1,8	2	17,5	1,48
6230.24		24	6,6	3	2	22	2,06

The st/steel lid 3709 is suitable for the PRIMA MATERA pans (except frypan).



Frypan with magnetic bottom INDUCTION and stainless steel handle



Code	Designation	Øcm	Hcm	Th.mm	Bottom ø cm	Kg
6224.20		20	4	2	13,5	1,3
6224.24		24	4	2	16,5	1,41
6224.28		28	4	2	20	1,86
6224.32		32	4	2	23	2,38

Conical sauté pan with magnetic bottom INDUCTION



Code	Designation	Øcm	Hcm	Liters.	Th.mm	Bottom ø cm	Kg
6236.20		20	7,2	1,7	2	13	1,32
6236.24		24	8,2	3,1	2	16,3	2,75

This flared sauté pan is ideal for boiling down cooking juices. That's often one of the reasons it's the professionals' first choice. The st/steel lid 3709 is suitable for the PRIMA MATERA pans (except frypan).

Stainless steel lid



Code	Designation	Øcm	Th.mm	Kg
3709.14N		14	1	0,24
3709.16N		16	1	0,28
3709.18N		18	1	0,33
3709.20N		20	1	0,39
3709.24N		24	1	0,51
3709.28		28	1	0,65



Stockpot with magnetic bottom INDUCTION and st/steel lid



Code	Designation	Øcm	Hcm	Liters.	Th.mm	Bottom ø cm	Kg
6244.20		20	18	5,7	2	22	3,1

This stockpot is a must for simmering family dishes and is the ideal utensil for preparing bouillabaisse, Irish stew, couscous ingredients, vegetable broth, etc.

High stewpan with magnetic bottom INDUCTION and st/steel lid



Code	Designation	Øcm	Hcm	Liters.	Th.mm	Bottom ø cm	Kg
6243.24		24	16,5	7,5	2	22	3,6

Sauté pan and st/steel lid



Rounded sauté pan with 2 st/steel handles



Code	Designation	Øcm	Hcm	Liters.	Th.mm	Bottom ø cm	Kg
6241.20		20	6	1,8	2	17,5	1,9
6241.24		24	6,8	3,1	2	22	2,51
6241.28		28	9,2	4,9	2	25	3,12

Code	Designation	Øcm	Hcm	Liters.	Th.mm	Bottom ø cm	Kg
6232.28	delivered with stainless steel lid	28	10	4,9	2	20,5	3,12

This sauté pan made of copper and stainless steel on the inside has a magnetic bottom and is adapted to all hotplates, including INDUCTION. The riveted handles are made of cast stainless steel.

Stewpan with magnetic bottom INDUCTION and st/steel lid

Code	Designation	Øcm	Hcm	Liters.	Th.mm	Bottom ø cm	Kg
6242.16		16	8,8	1,8	2	13,5	1,54
6242.20		20	10,3	3,3	2	17	2,21
6242.24		24	12,3	5,4	2	22	3,22
6242.28		28	13,5	8	2	25	4,07



This stewpan made of copper and stainless steel on the inside has a magnetic bottom and is adapted to all hotplates, including INDUCTION. The riveted handles are made of cast stainless steel.

WOK with 2 cast st/steel handles

Code	Designation	Øcm	Lcm	Hcm	Liters.	Th.mm	Bottom ø cm	Kg
6247.32	ø bottom 10 cm	32		12,5	4	2	17	2,5
3329.10	Grid for wok ø 32 cm		34,5					0,14
3429.32	Glass lid with stainless steel handle	32						1,1



Care :

- **The COPPER outside** : the colour changes on a heat sources. Use a special copper cleaner to give brilliance back to a copper utensil. Never use a metal sponge.
- **The STAINLESS STEEL inside** : easy care with a sponge and washing-up liquid.
- If you burn food in your utensil Inocuvre, soak during half a day with water and washing-up liquid.
- Cleaning in the dishwasher is not recommended. The copper utensils with cast steel handles may rust.



Stainless steel steamcooker

new
2019

Code	Designation	Øcm
3675.24		24



Steaming is a quick operation with this steamer with fits on the copper pans. Equipped with an handle. Tip from the chef: to make your vegetables glisten, plunge them into cold water once they are cooked.

COPPER STAINLESS STEEL INDUCTION

- Copper outside 90% = excellent heat diffusion
- Stainless steel inside 10% = matchless hygiene - ease of use
- Ergonomic cast steel riveted handles
- All heat sources including induction
- Made in France

PRIMA MATERA®
INOUIVRE INDUCTION 90%Cu



Saucepan with magnetic bottom INDUCTION, cast iron handle

new
2019



Code	Designation	Øcm	Hcm	Liters.	Th.mm
6306.14		14	7,3	1,2	2
6306.16		16	8,3	1,8	2
6306.18		18	9,3	2,5	2

This design of pan is the utensil professional kitchens can't do without. It is especially suited to boiling down (sauce making...). The walls are stainless steel on the inside. The cast steel handle is firmly riveted. 2mm-thick (90% copper and 10% stainless steel).

Sauté pan with magnetic bottom INDUCTION, cast iron handle

new
2019



Code	Designation	Øcm	Hcm	Liters.	Th.mm
6330.24		24	6,6	3	2

The copper lid6463 is suitable for this PRIMA MATERA pans with cast steel handles (except frypan).

Conical sauté pan with magnetic bottom INDUCTION, cast iron handle

new
2019



Code	Designation	Øcm	Hcm	Liters.	Th.mm
6336.20		20	7,2	1,7	2

This flared sauté pan is ideal for boiling down cooking juices. That's often one of the reasons it's the professionals' first choice. The st/steel lid 3709 is suitable for the PRIMA MATERA pans (except frypan).

Frypan with magnetic bottom INDUCTION, cast iron handle

new
2019



Code	Designation	Øcm	Hcm	Th.mm
6324.24		24	4	2
6324.28		28	4	2
6324.32		32	4	2

Stewpan with magnetic bottom INDUCTION with lid , cast iron handles

new
2019



Code	Designation	Øcm	Hcm	Liters.	Th.mm
6342.16		16	8,8	1,8	2
6342.20		20	10,3	3,3	2
6342.24		24	12,3	5,4	2
6342.28		28	13,5	8	2

The stewpan has high sides, which allows you to simmer food or cook large volumes of liquid, vegetables, etc. The moisture stays in the pot. The walls are stainless steel on the inside. The handles are firmly riveted.

Rounded sauté pan with magnetic bottom INDUCTION with copper lid, cast iron handles

new
2019



Code	Designation	Øcm	Hcm	Liters.	Th.mm
6332.28		28	10	4,9	2

INOUIVRE

- Copper outside 90% = excellent heat diffusion
- Stainless steel inside 10% = matchless hygiene - ease of use
- Ergonomic cast stainless steel riveted handles
- All heat sources except induction
- Made in France

ino cuivre



Saucepan



Code	Designation	Øcm	Hcm	Liters.	Th.mm	Kg
6406.14		14	7,8	1,2	1,5	0,63
6406.16		16	9	1,8	1,5	0,97
6406.18		18	10	2,5	1,5	1,37
6406.20		20	10,7	3,3	1,5	1,9
6406.24		24	13	6	2	2,67

A new 2mm-thick (90% copper and 10% stainless steel) professional and smart line INOUIVRE.

Round frypan



Code	Designation	Øcm	Hcm	Th.mm	Kg
6424.20		20	3,5	2	0,95
6424.24		24	3,7	2	1,3
6424.28		28	3,6	2	1,55
6424.32		32	5	2	2,2

It is the perfect frypan for quick cooking. It will also be an elegant product in your kitchen thanks to its design.

Sauté pans



Code	Designation	Øcm	Hcm	Liters.	Th.mm	Kg
6430.16	Straight sauté-pan	16	5,8	1	1,5	0,75
6430.20	Straight sauté-pan	20	6,5	1,8	1,5	1,08
6430.24	Straight sauté-pan	24	7,5	3	2	2
6436.20	Conical sauté-pan	20	7,2	1,7	1,5	1,32
6436.24	Conical sauté-pan	24	7,5	3,1	2	1,8

Made up of 90% copper and 10% stainless steel, this sauté-pan will ensure you a good heat convection and is easy to clean.

Wok with 2 cast st/steel handles



Code	Designation	Øcm	Lcm	Hcm	Liters.	Th.mm	Kg
6440.32	wok	32		12	4	2	2,4
3329.10	Grid for wok ø 32 cm		34,5				0,14
3429.32	Glass lid for wok	32					1,1

Sauté pan with 2 cast stainless steel handles with lid



Code	Designation	Øcm	Hcm	Liters.	Th.mm	Kg
6441.20		20	6,2	1,8	1,5	1,5
6441.24		24	7	3	2	2,38
6441.28		28	9	4,9	2	3,36

With a 2 mm thickness this sauté pan allows quick browning of food. It is really practical and elegant.

Stewpan with 2 cast stainless steel handles with lid



Code	Designation	Øcm	Hcm	Liters.	Th.mm	Kg
6442.16		16	9	1,8	1,5	1,28
6442.20		20	11	3,3	1,5	2,23
6442.24		24	12	5,4	2	3,25
6442.28		28	13,5	8	2	3,96

The stewpan has high sides which allows you to simmer food or cook large volumes of liquid, vegetables, etc. The moisture stays in the pot. The material that composes it offers an extraordinary cooking quality.

High stewpan with 2 cast stainless steel handles with lid



Code	Designation	Øcm	Hcm	Liters.	Th.mm	Kg
6443.24		24	16,5	7,5	2	3

Stockpot with 2 cast stainless steel handles with lid



Code	Designation	Øcm	Hcm	Liters.	Th.mm	Kg
6444.20		20	18	5,7	2	3

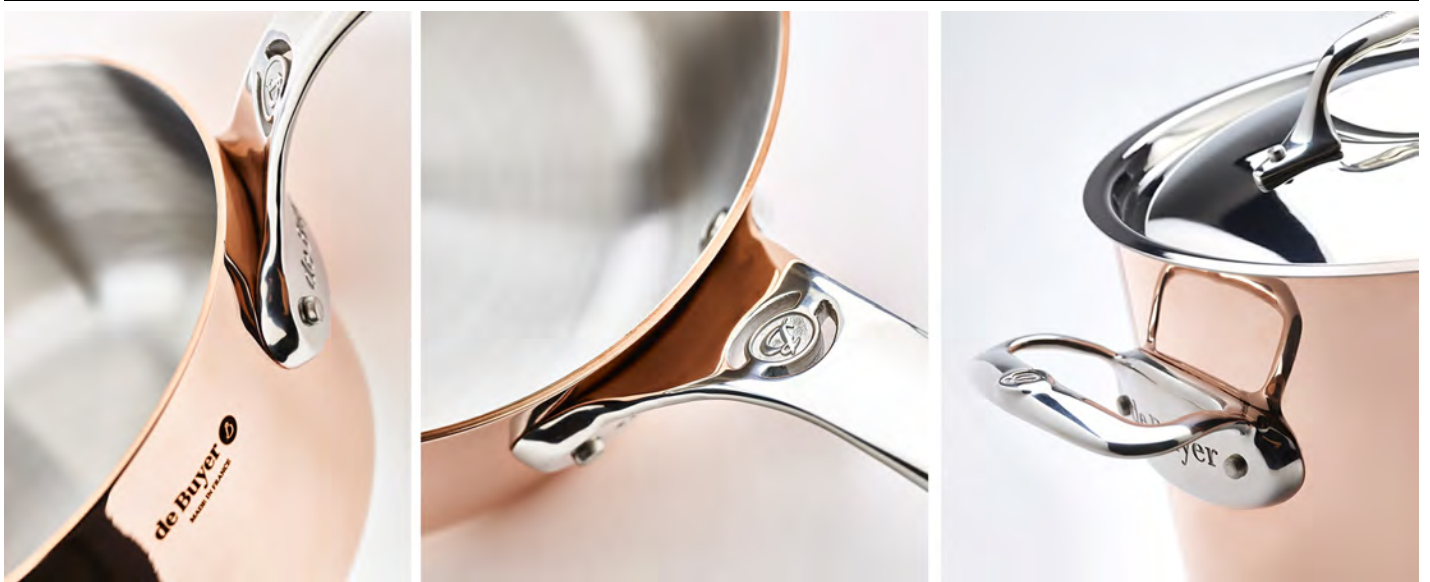

Stainless steel lid



Code	Designation	Øcm	Th.mm	Kg
3709.14N		14	1	0,24
3709.16N		16	1	0,28
3709.18N		18	1	0,33
3709.20N		20	1	0,39
3709.24N		24	1	0,51
3709.28		28	1	0,65

Suitable for all range products. Cast stainless steel handle.

Oval stewpan with 2 cast stainless steel handles & lid - 2 mm thick



Code	Designation	Lcm	Wcm	Hcm	Liters.	Th.mm	Kg
6426.30	Stewpan with lid	30	22	13	6,5	2	3,6
3708.30	Oval lid alone						

Oval fish frypan L. 32 cm - handle on the short axis



Code	Designation	Lcm	Wcm	Hcm	Th.mm	Kg
6425.32		32	23	4,8	2	1,81

Mini blinis pan ø 10 cm - 2-mm thick



Code	Designation	Øcm	Th.mm	Kg
6424.10		10	2	0,26

Roasting-pan - copper st/steel - with 2 riveted cast st/steel handles



Code	Designation	Lcm	Wcm	Hcm	Th.mm	Kg
6427.35	Roasting pan	41	27	8	2	2,2

Multilayer material : copper alu st/steel
 Handles made of cast stainless steel
 Suitable also for domestic oven.



Saucepan, cast-iron handle



Code	Designation	Øcm	Hcm	Liters.	Th.mm	Kg
6460.01	Set of 5 - ø12-20 cm					8,28
6460.12	2,5 mm th	12	7	0,8	1,5	0,77
6460.14	2,5 mm th	14	7,5	1,2	1,5	1,23
6460.16	2,5 mm th	16	9	1,8	1,5	1,3
6460.18	2,5 mm th	18	9	2,5	1,5	1,61
6460.20	2,5 mm th	20	10,8	3,3	1,5	1,96

This design of pan is the utensil professional kitchens can't do without. It is especially suited to boiling down (sauce making...). The walls are stainless steel on the inside. The cast steel handle is firmly riveted. 2mm-thick (90% copper and 10% stainless steel). All

hotplates except induction.

Sauté-pan, frypan, cast iron handle



Code	Designation	Øcm	Hcm	Liters.	Th.mm	Kg
6464.16	Conical sauté-pan, no lid	16	6	0,9	1,5	0,9
6464.20	Conical sauté-pan, no lid	20	7	1,7	1,5	1,38
6464.24	Conical sauté-pan, no lid	24	8	2,9	2	1,93
6462.16	Sauté-pan, no lid	16	5,5	1	1,5	0,84
6462.20	Sauté-pan, no lid	20	6	1,8	1,5	1,45
6462.24	Sauté-pan, no lid	24	7	3,1	2	2,15
6462.28	Sauté-pan, no lid	28	8,5	4,9	2	2,85
6465.20	Frypan	20	3,4		2	1,04
6465.24	Frypan	24	4,2		2	1,48
6465.28	Frypan	28	3,6		2	1,7
6465.32	Frypan	32	5		2	2,44

Heavy duty sauté pans and frying pans are utensils professional kitchens can't do without. The straight-sided sauté pan allows quick browning of food, the tapered sauté pan is ideal for boiling down sauces, and the frying pan turns out to be perfect for frying, searing, and flambéing food. The walls are stainless steel on the inside. The cast steel handle is firmly riveted. All hotplates except induction.

Lid, cast-iron handle



Code	Designation	Øcm	Kg
6463.12	1,2 mm th	12	0,17
6463.14	1,2 mm th	14	0,21
6463.16	1,2 mm th	16	0,27
6463.18	1,2 mm th	18	0,35
6463.20	1,2 mm th	20	0,41
6463.24	1,2 mm th	24	0,68
6463.28	1,2 mm th	28	0,8

The inside of the lid is stainless steel. The handle is made from cast steel and is firmly riveted.

Stewpan with lid, cast-iron handles



Code	Designation	Øcm	Hcm	Liters.	Th.mm	Kg
6466.16		16	8,8	1,8	1,5	1,5
6466.20		20	10,5	3,3	1,5	2
6466.24		24	12,5	5,4	2	3,24
6466.28		28	13,5	8	2	4,05

The stewpan has high sides, which allows you to simmer food or cook large volumes of liquid, vegetables, etc. The moisture stays in the pot. The walls are stainless steel on the inside. The handles are firmly riveted. All hotplates except induction.

Sauté pan with lid, with 2 cast iron handles



Code	Designation	Øcm	Hcm	Liters.	Th.mm	Kg
6461.20		20	6,1	1,8	1,5	1,51
6461.24		24	7	3,1	2	2,59
6461.28		28	9	4,9	2	3,47

All hotplates except induction.

High stewpan with lid



Code	Designation	Øcm	Hcm	Liters.	Th.mm	Kg
6467.24		24	18,5	7,5	2	3,67

All hotplates except induction.

Stockpot with lid



Code	Designation	Øcm	Hcm	Liters.	Th.mm	Kg
6468.20		20	18,5	5,7	2	2,9

All hotplates except induction.



INOUCIVRE Copper 90% Stainless steel 10%

Ergonomic brass riveted handles

Suitable for cooking as well as presentation on table and making flambés

All heat sources except induction



Saucepan



Code	Designation	Øcm	Hcm	Liters.	Th.mm	Kg
6445.01	Set of 5 - ø12-20					4,83
6445.10		10	5,2			0,33
6445.12	1,2 mm th	12	6	0,8	1,5	0,5
6445.14	1,2 mm th	14	7	1	1,5	0,63
6445.16	1,2 mm th	16	8,5	1,6	1,5	0,8
6445.18	1,2 mm th	18	9	2,5	1,5	0,99
6445.20	1,2 mm th	20	10	3,5	1,5	1,21

This design of pan is especially well adapted to the table and making flambés or can be used simply to decorate the kitchen interior. It can also be used for cooking on medium-power heat

sources. The walls are stainless steel on the inside, which makes for easy upkeep and removes the need for re-tinning. Riveted brass handle.

Sauté-pan without lid



Code	Designation	Øcm	Hcm	Liters.	Th.mm	Kg
6448.16	1,5 mm th	16	5	1	1,5	0,75
6448.20	1,5 mm th	20	6	1,8	1,5	0,94
6448.24	1,5 mm th	24	6,5	3	2	1,81

The straight-sided sauté pan allows quick browning of food and proves ideal for serving and for flambéing. The walls are stainless steel on the inside, which makes for easy upkeep and removes the need for re-tinning. The brass handle is firmly riveted.

Frypan with brass handle



Code	Designation	Øcm	Hcm	Th.mm	Kg
6450.20		20	3	2	0,91
6450.24		24	4	2	1,3
6450.28		28	4,5	2	1,82

These frying pans in stainless-lined copper prove perfect for frying and searing using medium-power heat sources, for flambéing food, and give a perfect appearance on the table. The skirt is stainless steel on the inside, which makes for easy upkeep and

removes the need for re-tinning. The brass handle is firmly riveted.

Mini-frypan ø 13 cm with riveted brass handle



Code	Designation	Øcm	Wcm	Hcm	Kg
6450.13	mini frypan	9,3	13	3,2	0,47

Round dish, 2 handles



Code	Designation	Øcm	Hcm	Th.mm	Kg
6449.12	1,2 mm th	12	2	2	0,34
6449.16	1,2 mm th	16	3	2	0,55
6449.20	1,2 mm th	20	3	2	0,78
6449.24	1,2 mm th	24	4,2	2	1,23

This round dish is used a lot for cooking eggs, making gratins, or perhaps for making crème brûlées. It makes for an elegant appearance on the table. The skirt is stainless steel on the inside, which makes for easy upkeep and removes the need for re-tinning.

The brass handles are firmly riveted.

Oval dish, 2 handles



Code	Designation	Lcm	Wcm	Hcm	Th.mm	Kg
6451.32		32	23	4,5	1,5	1,02
6451.36		36	26,2	4,5	1,5	1,2

The dish proves ideal for serving and for flambéing. The skirt is stainless steel on the inside, which makes for easy upkeep and removes the need for re-tinning. The brass handles are firmly riveted. Do not use directly on a heat sources.

Sauté-pan with lid, brass handles



Code	Designation	Øcm	Hcm	Liters.	Th.mm	Kg
6446.20		20	6	1,8	1,5	1,44
6446.24	2,5 mm th	24	7	3,2	2	2,48
6446.28	2,5 mm th	28	9	5,5	2	3,37

The two-handed sauté dish allows quick browning of food. It has the same uses as a one-handed sauté pan, but turns out to be more practical to handle and takes up less space when stored away or when on the burner. The walls are stainless steel on the inside.

The brass handles are firmly riveted.

Round stewpan with lid



Code	Designation	Øcm	Hcm	Liters.	Th.mm	Kg
6447.10	mini stewpan with lid	10	5,5			0,48
6447.16	1,5 mm th	16	8	1,6	1,5	1,04
6447.20	1,5 mm th	20	10	3,5	1,5	1,59
6447.24	1,5 mm th	24	11,5	5,2	2	3,13



This casserole is an elegant way of serving at the table. It can also be used for cooking on medium-power heat sources. The skirt is stainless steel on the inside, which makes for easy upkeep and removes the need for re-tinning. The brass handles are firmly riveted.

Lid



Code	Designation	Øcm	Th.mm	Kg
6454.09	Round handle	9		0,09
6454.10	Round handle	10		0,1
6454.12		11,5	1,2	0,17
6454.14		13,5	1,2	0,21
6454.16		15	1,2	0,29
6454.18		17	1,2	0,36
6454.20		19,5	1,2	0,42
6454.24		23,5	1,2	0,62
6454.28		27	1,2	0,82

The inside of the lid is stainless steel. The brass handle is firmly riveted.

WOK with brass handle



Code	Designation	Øcm	Hcm	Th.mm	Kg
6432.32		30,9	8,5	2	2,25
3429.32	Glass lid with st/steel knob for wok :	32			1,1

The wok has forever been the universal Asian kitchen utensil, and it turns out to be ideal for a natural, dietetic cuisine, which needs very little fat and preserves the food's original taste. The bowl is stainless steel on the inside, which makes for easy upkeep and removes the need

for re-tinning. The brass handle is firmly riveted.

Mini pans , copper st/steel with brass handles



Code	Designation	Øcm	Wcm	Hcm	Liters.	Kg
6453.09	Saucepan with lid	9		4,5	0,3	0,36
	Saucepan without lid					
6445.09		9		4,5	0,3	0,3
6445.10		10		5,2		0,33
6450.13	mini frypan	9,3	13	3,2		0,47
6447.10	mini stewpan with lid	10		5,5		0,48

The small saucepan is perfect for serving sauces. It ensures an elegant appearance. The walls are stainless steel on the inside, which makes for easy upkeep and removes the need for re-tinning. The brass handle is firmly riveted.

Copper massive conical jam pans with cast-iron handles



Code	Designation	Øcm	Hcm	Liters.	Th.mm	Kg
6200.38N	Conical jam pan, 1 mm th	38	15	9	1,2	1,5
6202.40N	Conical jam pan, 2 mm th	40	14,4	12	1,7	3,4

These copper basins are genuine traditional utensils used for bringing sugar or fruit to a boil to make jams, jellies, or preserves. The cast steel handles are firmly riveted.

Copper eggwhites bowl



Code	Designation	Øcm	Th.mm	Kg
6580.20	1 ring-handle	20	1,2	0,91
6580.26	1 ring-handle	26	1,2	1,06
6580.32	1 ring-handle	32	1,2	1,63
6581.20	With 2 handles	20	1,2	1,1
6581.26	With 2 handles	26	1,2	1,41
6581.32	With 2 handles	32	1,2	1,8

Made from solid copper, these half-round eggwhite basins are the traditional utensils used by professionals. The basins are perfect for beating egg-whites until stiff.



Copper "Bordelais" fluted moulds



Code	Designation	Øcm	Hcm	Liters.	Th.mm	Kg
TINNED COPPER						
6820.35N		3,5	3,3	0,03	0,8	0,01
6820.45N		4,5	4,2	0,06	1	0,03
6820.55N		5,5	5	0,1	1,2	0,05

These moulds allow you to use the traditional method for making Bordeaux's famous crunchy Canelé cakes. The copper ensures perfect heat convection, which allows good caramelization of the juices and gives a delicious taste.

Copper cleaner



Code	Designation	Øcm	Hcm	Liters.	Kg	PU
4200.01N	150 ml	7,5	6	0,15	0,24	6
4200.11N	1000 ml	13	14	1	1,29	1

This cleaner gives brilliance back to your utensils. It is really easy to use: First, clean your pan. Wet the sponge with hot water and dip it in the cleaner. Rub the whole pan with the sponge. Then rinse it with hot water and dry it carefully.



MILLS

De Buyer mills come in a variety of styles and help your dishes to express their full flavour potential. Our salt and pepper mills stem from our traditional know-how and include Marlux steel mechanisms with lifetime guarantee. They are made of beech wood from French PEFC forests which gives them a warm, gentle and sensual feel. Wooden mills have the “Origine France Garantie” label.

- 84 -

Wooden mills

- 95 -

Wooden & acrylic mills

- 97 -

Acrylic mills

- 101 -

Acrylic & stainless steel mills



B BOIS mills made of beechwood with a beeswax protective finishing.

Marlux mechanism. ORIGINE FRANCE GARANTIE.

'B Bois' products are exclusively sold via physical retailers.



Spice mills 'B BOIS' RUMBA 20 cm

new
2019



Code	Designation	Øcm	Hcm	Kg
	PEPPER MILL			
P230.201111	Steel mechanism	6,4	21	0,33
	SALT MILL			
S330.201111	St/steel mechanism	6,4	21	0,33
	SPICE MILL			
C030.201111	Ceramic mechanism	6,4	21	0,33

Steel pepper mechanism and stainless steel salt mechanism.
Lifetime warranty for steel mechanism.
Ceramic mechanism suitable for various spices.
Certified "ORIGINE FRANCE GARANTIE".

Spice mills 'B BOIS' RUMBA 14 cm

new
2019



Code	Designation	Øcm	Hcm	Kg
	PEPPER MILL			
P230.141111	Steel mechanism	4,5	14	0,15
	SALT MILL			
S330.141111	St/steel mechanism	4,5	14	15
	SPICE MILL			
C030.141111	Ceramic mechanism	4,5	14	0,15

Steel pepper mechanism and stainless steel salt mechanism. Certified "ORIGINE FRANCE GARANTIE".
Lifetime warranty for steel mechanism.
Ceramic mechanism suitable for various spices.

Spice mills 'B BOIS' BOOGIE 7 cm

new
2019



Code	Designation	Øcm	Hcm	Kg
	PEPPER MILL			
P292.071111	Steel mechanism	7	9	0,15
	SALT MILL			
S392.071111	St/steel mechanism	7	9	0,15
	SPICE MILL			
C092.071111	Ceramic mechanism	7	9	0,14

Steel pepper mechanism and stainless steel salt mechanism. Certified "ORIGINE FRANCE GARANTIE".
Lifetime warranty for steel mechanism.
Ceramic mechanism suitable for various spices.



French manufacturer since 1875, the company Marlux, which obtained the EPV label (Living Heritage Company) granted by Ministry of Economy, is a leading manufacturer of pepper and salt mills. The company De Buyer Industries, French manufacturer of high-quality kitchen utensils, acquired Marlux to complete its field of activities. Both are

reputed French companies sharing the same values of know-how, top-end production and also the same business goals in France and abroad. De Buyer offers rich and innovative ranges of high-quality mills equipped with Marlux mechanisms and manufactured on its production sites in France.

The wooden mills - body and lid - are certified ORIGINE FRANCE GARANTIE; it concerns over 150 pepper, salt and spices mills equipped with steel, stainless steel or ceramic mechanisms.

mechanisms **marlux**

STEEL MECHANISMS

Life time warranty*
Made in France



Pepper mill mechanism
Steel

Salt mill mechanism
Stainless steel



SALT knob

Grinding setting with the mill knob



SALT knob



CERAMIC MECHANISMS

for various spices,
pepper, herbs, etc.

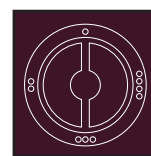
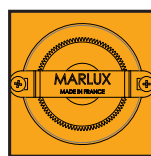

Grinding setting with the mill knob

4 grinding setting with the mill base



SPICES Round knob





This range of classical mills is made of beech wood (PEFC- Pan European Forest Certification, beech wood used comes from sustainably managed forest). Beech wood is either natural or tinted and then varnished.

These mills made of wood are available with different mechanisms:

- **With high quality cut and hardened steel mechanism for pepper mills.**
- **With stainless steel mechanism for salt mills.**

These steel mechanism are lifetime guaranteed against manufacturing defects, within a normal use and does not cover damages caused by shock or misuse.

- **With a ceramic mechanism for spice mills** (coarse white salt, coarse sea salt, mixed peppercorns, herbes de Provence). These mills are guaranteed against manufacturing defects for three years.

The upper knob sets grinding size. These mills are delivered empty.

Pepper/Salt mill PASO 10 cm, steel mechanisms

Code	Designation	Hcm	Kg
PEPPER MILL			
P240.100101	Natural	10	0,11
P240.100202	Dark	10	0,11
P240.100303	Matte white	10	0,11
P240.100404	Matte black	10	0,11
SALT MILL			
S340.100101	Natural	10	0,09
S340.100202	Dark	10	0,09
S340.100303	Matte white	10	0,09
S340.100404	Matte black	10	0,09



The mini traditional ideal table model. Indispensable and always fashionable. Steel pepper mechanism and stainless steel salt mechanism. Lifetime warranty. Certified "ORIGINE FRANCE GARANTIE".



Spices mill PASO 10 cm, ceramic mechanism



Code	Designation	Hcm	Kg
C040.100101	Natural	10	0,11
C040.100202	Dark	10	0,11
C040.100303	Matte white	10	0,11
C040.100404	Matte black	10	0,11

Ceramic mechanism suitable for various spices. Wooden mill certified "ORIGINE FRANCE GARANTIE".

Salt shaker PASO 10 cm



Code	Designation	Hcm	Kg
M340.100101	Natural	8,8	0,05
M340.100202	Dark	8,8	0,05

The mini traditional ideal table model. Indispensable and always fashionable.

collection
JAVA



JAVA model is the traditional mill: the wood comes in 4 natural and classical colours according to the models:

light wood, dark wood, matte white and matte black.

- Available in pepper mill, salt mill and spices mill from 14 to 25 cm.
- Available in pepper and salt mills from 14 to 40 cm.
- The model 70 cm exists only for pepper with a steel mechanism.

Pepper/Salt mill JAVA 14 cm, steel mechanisms



Code	Designation	Hcm	Kg
PEPPER MILL			
P245.140101	Natural	14	0,13
P245.140202	Dark	14	0,13
P245.140303	Matte white	14	0,13
P245.140404	Matte black	14	0,13
SALT MILL			
S345.140101	Natural	14	0,12
S345.140202	Dark	14	0,12
S345.140303	Matte white	14	0,12
S345.140404	Matte black	14	0,12

Classical wooden mill. Steel pepper mechanism and stainless steel salt mechanism. Lifetime warranty. Certified "ORIGINE FRANCE GARANTIE".



Spices mill JAVA 14 cm, ceramic mechanism



Code	Designation	Hcm	Kg
C045.140101	Natural	14	0,13
C045.140202	Dark	14	0,13
C045.140303	Matte white	14	0,13
C045.140404	Matte black	14	0,13

Ceramic mechanism suitable for various spices. Wooden mill certified "ORIGINE FRANCE GARANTIE".

Pepper/Salt mill JAVA 18 cm, steel mechanisms

new
2019



Code	Designation	Hcm
PEPPER MILL		
P246.180101	Naturel	18
P246.180202	Dark	18
P246.180303	Matte white	18
P246.180404	Matte black	18
SALT MILL		
S346.180101	Natural	18
S346.180202	Dark	18
S346.180303	Matte white	18
S346.180404	Matte black	18

Classical wooden mill. Steel pepper mechanism and stainless steel salt mechanism. Lifetime warranty. Certified "ORIGINE FRANCE GARANTIE".

Spices mill JAVA 18 cm, ceramic mechanism

new
2019



Code	Designation	Hcm
C046.180101	Natural	18
C046.180202	Dark	18
C046.180303	Matte white	18
C046.180404	Matte black	18

Ceramic mechanism suitable for various spices. Wooden mill certified "ORIGINE FRANCE GARANTIE".

Pepper/Salt mill JAVA 21 cm, steel mechanisms



Code	Designation	Hcm	Kg
PEPPER MILL			
P247.210101	Natural	21	0,24
P247.210202	Dark	21	0,24
P247.210303	Matte white	21	0,24
P247.210404	Matte black	21	0,24
SALT MILL			
S347.210101	Natural	21	0,22
S347.210202	Dark	21	0,22
S347.210303	Matte white	21	0,22
S347.210404	Matte black	21	0,22

Classical wooden mill. Steel pepper mechanism and stainless steel salt mechanism. Lifetime warranty. Certified "ORIGINE FRANCE GARANTIE".

Spices mill JAVA 21 cm, ceramic mechanism



Code	Designation	Hcm	Kg
C047.210101 Natural		21	0,24
C047.210202 Dark		21	0,24
C047.210303 Matte white		21	0,24
C047.210404 Matte black		21	0,24

Ceramic mechanism suitable for various spices. Wooden mill certified "ORIGINE FRANCE GARANTIE".

Pepper/Salt mill JAVA 25 cm, steel mechanisms



Code	Designation	Hcm	Kg
	PEPPER MILL		
P249.250101 Natural		25	0,3
P249.250202 Dark		25	0,3
P249.250303 Matte white		25	0,3
P249.250404 Matte black		25	0,29
	SALT MILL		
S349.250101 Natural		25	0,27
S349.250202 Dark		25	0,27
S349.250303 Matte white		25	0,27
S349.250404 Matte black		25	0,3

Classical wooden mill. Steel pepper mechanism and stainless steel salt mechanism. Lifetime warranty. Certified "ORIGINE FRANCE GARANTIE".

Spices mill JAVA 25 cm, ceramic mechanism



Code	Designation	Hcm	Kg
C049.250101 Natural		25	0,3
C049.250202 Dark		25	0,3
C049.250303 Matte white		25	0,3
C049.250404 Matte black		25	0,3

Ceramic mechanism suitable for various spices. Wooden mill certified "ORIGINE FRANCE GARANTIE".

Pepper/Salt mill JAVA 30 cm, steel mechanisms



Code	Designation	Hcm	Kg
	PEPPER MILL		
P253.300101 Natural		30	0,56
P253.300202 Dark		30	0,56
P253.300303 Matte white		30	0,56
P253.300404 Matte black		30	0,56
	SALT MILL		
S353.300101 Natural		30	0,56
S353.300202 Dark		30	0,56
S353.300303 Matte white		30	0,56
S353.300404 Matte black		30	0,56

Classical wooden mill. Steel pepper mechanism and stainless steel salt mechanism. Lifetime warranty. Certified "ORIGINE FRANCE GARANTIE".

Pepper/Salt mill JAVA 40 cm, steel mechanisms



Code	Designation	Hcm	Kg
PEPPER MILL			
P251.400101	Natural	40	0,93
P251.400202	Dark	40	0,93
SALT MILL			
S351.400101	Natural	40	0,93
S351.400202	Dark	40	0,89

Classical wooden mill. Steel pepper mechanism and stainless steel salt mechanism. Lifetime warranty. Certified "ORIGINE FRANCE GARANTIE".

Pepper mill JAVA 70 cm

new
2019

Code	Designation	Hcm	Kg
P256.700101	Natural	70	2
P256.700202	Dark	70	2

Steel mechanism. Lifetime warranty. Certified "ORIGINE FRANCE GARANTIE".

Pepper/Salt mill RUMBA 14 cm, steel mechanisms

new
2019

Code	Designation	Hcm	Kg
PEPPER MILL			
P230.140101	Natural	14	0,14
P230.140202	Dark	14	0,14
P230.140303	Matte white	14	0,14
P230.140404	Matte black	14	0,14
SALT MILL			
S330.140101	Natural	14	0,14
S330.140202	Dark	14	0,14
S330.140303	Matte white	14	0,14
S330.140404	Black	14	0,14

A mill with pleasant and well-rounded curves. It offers a good grip, is a convenient size and is very handy in the kitchen and on the table. Steel pepper mechanism and stainless steel salt mechanism.

Lifetime warranty. Certified "ORIGINE FRANCE GARANTIE".

Spices mill RUMBA 14 cm

new
2019

Code	Designation	Hcm	Kg
C030.140101	Natural	14	0,15
C030.140202	Dark	14	0,15
C030.140303	White matte	14	0,15
C030.140404	Black matte	14	0,15

Ceramic mechanism suitable for various spices. Wooden mill certified "ORIGINE FRANCE GARANTIE".

Pepper/Salt mill RUMBA 20 cm, steel mechanisms



Code	Designation	Hcm	Kg
PEPPER MILL			
P230.200101	Natural	20	0,34
P230.200202	Dark	20	0,34
SALT MILL			
S330.200101	Natural	20	0,34
S330.200202	Dark	20	0,34

A mill with pleasant and well-rounded curves. It offers a good grip, is a convenient size and is very handy in the kitchen and on the table. Steel pepper mechanism and stainless steel salt mechanism. Lifetime warranty. Certified "ORIGINE FRANCE GARANTIE".

Spices mill RUMBA 20 cm



Code	Designation	Hcm	Kg
C030.200101	Natural	20	0,35
C030.200202	Dark	20	0,35

Ceramic mechanism suitable for various spices. Wooden mill certified "ORIGINE FRANCE GARANTIE".

Pepper/Salt mill JOTA, steel mechanisms



Code	Designation	Hcm	Kg
PEPPER MILL			
P223.120101	Natural	12	0,24
P223.120606	Ebony	12	0,24
SALT MILL			
S323.120101	Natural	12	0,21
S323.120606	Ebony	12	0,21

A cylindrical mill with a sleek design, with its grooved aluminum ring and elegant button inlaid in the lid. For the pepper model, the milling adjustment is done from the bottom with a button provided in the mechanism. Steel pepper mechanism and stainless

steel salt mechanism. Lifetime warranty. Certified "ORIGINE FRANCE GARANTIE".

Pepper/Salt mill SPRINGAR, steel mechanisms



Code	Designation	Hcm	Kg
PEPPER MILL			
P227.130170	Natural	13	0,18
P227.130670	Ebony	13	0,12
SALT MILL			
S327.130170	Natural	13	0,17
S327.130670	Ebony	18,2	0,16

A table model with an industrial style design, a modern combination of stainless steel and wood. Steel pepper mechanism and stainless steel salt mechanism. Lifetime warranty.

Pepper/Salt mill POGO, steel mechanisms



Code	Designation	Hcm	Kg
P222.110606	Pepper mill	11	0,11
S322.110606	Salt mill	11	0,09

A pleasant curve and a matt black finish give simplicity and elegance to this little table mill. Steel pepper mechanism and stainless steel salt mechanism. Lifetime warranty. Certified "ORIGINE FRANCE GARANTIE".

Pepper/Salt mill VALSE, steel mechanisms



Code	Designation	Hcm	Kg
	PEPPER MILL		
P224.110671	Matte black	11	0,18
	SALT MILL		
S324.110671	Matte black	11	0,16

The mill of the large tables with its wooden body with pleasant curves and its lid in metallic silver polished brightly . Steel pepper mechanism and stainless steel salt mechanism. Lifetime warranty.

Wooden spice mills BOOGIE 7 cm

new
2019



Code	Designation	Øcm	Hcm	Kg
	PEPPER MILL			
	Steel mechanism			
P292.070101	Natural	9	7	0,15
P292.070202	Dark	9	7	0,15
	SALT MILL			
	Stainless steel mechanism			
S392.070101	Natural	9	7	0,15
S392.070202	Dark	9	7	0,15
	SPICE MILL			
	Ceramic mechanism			
C092.070101	Natural	9	7	0,14
C092.070202	Dark	9	7	0,14

Steel pepper mechanism and stainless steel salt mechanism. Certified "ORIGINE FRANCE GARANTIE".
Lifetime warranty for steel mechanism.
Ceramic mechanism suitable for various spices.

Coarse grind pepper mill JAVA STEAK



Code	Designation	Hcm	Kg
M245.140404	Matte black	14	0,13

Special steel mechanism for pepper mill cracked : larger space between the steel teeth to obtain cracked ground pepper
Certified ORIGINE FRANCE GARANTIE.

Nutmeg mill SOKO with crank st/steel handle



Code	Designation	Hcm	Kg
M516.100101	Natural	10	0,13
M516.100202	Dark	10	0,13

The nutmeg, a specialty MARLUX: this original mill has a mechanism in steel unpublished. The nutmeg is stuck on a spring stem and three large teeth hold it on the sharpened plate. Nutmeg is then easily grated by turning handle.
Certified ORIGINE FRANCE GARANTIE.



This range of classical mills is made of beech wood (PEFC- Pan European Forest Certification, beech wood used comes from sustainable managed forest). **The wood is lacquered : one coat of white lacquer then three coats of the color.**

These mills made of wood are available with different mechanisms:

- with a **ceramic mechanism for spice mills** (coarse white salt, coarse sea salt, mixed peppercorns, herbes de Provence).
- with **stainless steel mechanism for salt mills.**
- with high quality cut and **hardened steel mechanism for pepper mills.**

The upper knob sets grinding size. These mills are delivered empty.

Pepper/Salt lacquered mill JAVA 14 cm, steel mechanisms



Code	Designation	Hcm	Kg
PEPPER MILL			
P245.143131	White	14	0,13
P245.143232	Red	14	0,13
P245.143333	Black	14	0,13
P245.143434	Taupe	14	0,13
P245.143535	Green	14	0,13
P245.143636	Curry	14	0,13
P245.143737	Grey	14	0,13
P245.144040	Orange	14	0,13
P245.144444	Blue	14	0,13
SALT MILL			
S345.143131	White	14	0,12
S345.143232	Red	14	0,12
S345.143333	Black	14	0,12
S345.143434	Taupe	14	0,12
S345.143535	Green	14	0,12
S345.143636	Curry	14	0,12
S345.143737	Grey	14	0,12
S345.144040	Orange	14	0,12
S345.144444	Blue	14	0,13

Steel pepper mechanism and stainless steel salt mechanism. Lifetime warranty. This range of classical mills is made of beech wood. The wood is lacquered : one coat of white lacquer

then three coats of the color. The glossy lacquered finish and the vibrant shades bring a colourful touch and brighten up the kitchen and table.

Spices lacquered mill JAVA 14 cm, ceramic mechanism



Code	Designation	Hcm	Kg
C045.143131	White	14	0,13
C045.143232	Red	14	0,13
C045.143333	Black	14	0,13
C045.143535	Green	14	0,13
C045.143434	Taupe	14	0,13
C045.143636	Curry	14	0,13
C045.143737	Grey	14	0,13
C045.144040	Orange	14	0,13
C045.144444	Blue	14	0,13

Ceramic mechanism suitable for various spices. This range of classical mills is made of beech wood. The wood is lacquered : one coat of white lacquer then three coats of the color. The glossy lacquered finish and the vitamin shades bring a colourful touch and brighten up the kitchen and table.

Pepper/Salt lacquered mill RUMBA 20 cm, steel mechanisms



Code	Designation	Hcm	Kg
PEPPER MILL			
P230.203131	White	20	0,34
P230.203232	Red	20	0,34
P230.203333	Black	20	0,34
P230.203434	Taupe	20	0,34
P230.203535	Green	20	0,34
P230.203636	Curry	20	0,34
P230.203737	Grey	20	0,34
P230.204040	Orange	20	0,34
P230.204444	Blue	20	0,35
SALT MILL			
S330.203131	White	20	0,32
S330.203232	Red	20	0,32
S330.203333	Black	20	0,32
S330.203434	Taupe	20	0,32
S330.203535	Green	20	0,32
S330.203636	Curry	20	0,32
S330.203737	Grey	20	0,32
S330.204040	Orange	20	0,32
S330.204444	Blue	20	0,35

Steel pepper mechanism and stainless steel salt mechanism. Lifetime warranty. This range of classical mills is made of beech wood. The wood is lacquered : one coat of white lacquer

then three coats of the color. The glossy lacquered finish and the vitamin shades bring a colourful touch and brighten up the kitchen and table.

Spices lacquered mill RUMBA 20 cm, ceramic mechanism



Code	Designation	Hcm	Kg
C030.203131	White	20	0,35
C030.203232	Red	20	0,35
C030.203333	Black	20	0,35
C030.203434	Taupe	20	0,35
C030.203535	Green	20	0,35
C030.203636	Curry	20	0,35
C030.203737	Grey	20	0,35
C030.204040	Orange	20	0,35
C030.204444	Blue	20	0,35

Ceramic mechanism suitable for various spices. This range of classical mills is made of beech wood. The wood is lacquered : one coat of white lacquer then three coats of the color. The glossy lacquered finish and the vitamin shades bring a colourful touch

and brighten up the kitchen and table.

The mills with a transparent acrylic body are filled with pepper or salt according to the model.
 The acrylic body is useful to view the spices in the mill.
 The wooden top is made of beech wood.

These mills are available with different mechanisms:

- With high quality cut and hardened steel mechanism for pepper mills.
- With stainless steel mechanism for salt mills.
- With a ceramic mechanism for spice mills

A ceramic grinder is broadly used for any spice in the kitchen or on the table : all the peppers corns, white and sea salt, black salt from Hawai, pink salt from Himalaya, dry herbs, caraway, poppy or sesame seeds ...

The adjustment of the mecanism of these models is made from the bottom and allows to get 4 different sets of grinding.

Pepper/Salt mill FLAMENCO, steel mechanisms



Code	Designation	Hcm	Kg
PEPPER MILL			
P274.138301	Pepper mill 13 cm	13	0,17
P274.188301	Pepper mill 18 cm	18	0,23
SALT MILL			
S374.138301	Salt mill 13 cm	13	0,17
S374.188301	Salt mill 18 cm	18	0,23

Wood, transparency and the curved modern line bring lightness and elegance to your table. A mill that will also fit perfectly in the kitchen.
 Steel pepper mechanism and stainless steel salt mechanism.
 Lifetime warranty.

Pepper/Salt mill HIP HOP 11 cm, steel mechanisms



Code	Designation	Hcm	Kg
PEPPER MILL			
P286.118301	Natural	11	0,12
P286.118302	Dark	11	0,12
SALT MILL			
S386.118301	Natural	11	0,12
S386.118302	Dark	11	0,12

Steel pepper mechanism and stainless steel salt mechanism.
 Lifetime warranty. This mini table mill with its translucent acrylic shape gives a light impression to the table.

Spices mill HIP HOP 11 cm, ceramic mechanism



Code	Designation	Hcm	Kg
PEPPER MILL			
C286.118301	Natural	11	0,09
C286.118302	Dark	11	0,09
SALT MILL			
C386.118301	Natural	11	0,09
C386.118302	Dark	11	0,09

Ceramic mechanism suitable for various spices. This mini table mill with its translucent acrylic shape gives a light impression to the table.

Spices lacquered mill HIP HOP 11 cm, ceramic mechanism



Code	Designation	Hcm	Kg
PEPPER MILL			
C286.118331	White	11	0,09
C286.118332	Red	11	0,09
C286.118333	Black	11	0,09
C286.118334	Taupe	11	0,09
C286.118335	Green	11	0,09
C286.118336	Curry	11	0,09
C286.118337	Grey	11	0,09
C286.118340	Orange	11	0,09
C286.118344	Blue	11	0,09
SALT MILL			
C386.118331	White	11	0,09
C386.118332	Red	11	0,09
C386.118333	Black	11	0,09
C386.118334	Taupe	11	0,09
C386.118335	Green	11	0,09
C386.118336	Curry	11	0,09
C386.118337	Grey	11	0,09
C386.118340	Orange	11	0,09
C386.118344	Blue	11	0,09

Ceramic mechanism suitable for various spices. This mini table mill with its translucent acrylic shape gives a light impression to the table and its range of coloured lids adapts to all atmospheres.

Coarse sea salt mill PITOULEE with boxwood grinder

Code	Designation	Hcm	Kg
M888.128301	Coarse sea salt mill	12	0,13
M888.018301	Gift box with mill & 100 g of coarse sea salt		0,31



The only mill really suited to wet sea salt because it has no metal parts. The boxwood crusher, very hard wood, crushes the coarse gray salt that comes to complement your dishes with its iodized flavour.



The mills with a transparent acrylic body are filled with pepper, white salt, nutmeg or herbs , according to the models. The transparency brings design, style and lightness to the table.

These mills are available with different mechanisms:

- With high quality cut and hardened steel mechanism for pepper mills.
- With stainless steel mechanism for salt mills.
- With a ceramic mechanism for spice mills

A ceramic grinder is broadly used for any spice in the kitchen or on the table : all the peppers corns, white and sea salt, black salt from Hawaiï, pink salt from Himalaya, dry herbs, caraway, poppy or sesame seeds ...The adjustment of the mecanism of these models is made from the bottom and allows to get 4 different sets of grinding.

Pepper/Salt mill TANGO 11 cm, steel mechanisms



Code	Designation	Hcm	Kg
P286.118383 Pepper mill		11	0,12
S386.118383 Salt mill		11	0,12

This fully translucent model is both remarkable and discreet. With its adjusted ergonomics it is elegant and practical. Steel pepper mechanism and stainless steel salt mechanism. Lifetime warranty.

Spices mill TANGO 11 cm



Code	Designation	Hcm	Kg
C286.118383 Pepper mill		11	0,09
C386.118383 Salt mill		11	0,09

Ceramic mechanism suitable for various spices. 4 grinding settings with the mill base.

Pepper/Salt mill TANGO 14 cm, steel mechanisms



Code	Designation	Hcm	Kg
P287.148383	Pepper mill	14	0,2
S387.148383	Salt mill	14	0,22

This fully translucent model is both remarkable and discreet. With its adjusted ergonomics it is elegant and practical. Steel pepper mechanism and stainless steel salt mechanism. Lifetime warranty.

Spices mill TANGO 14 cm



Code	Designation	Hcm	Kg
C287.148383	Pepper mill	14	0,2
C387.148383	Salt mill	14	0,22

Ceramic mechanism suitable for various spices. 4 grinding settings with the mill base.

Pepper/Salt mill VIRA 10 cm, steel mechanisms



Code	Designation	Hcm	Kg
P280.108383	Pepper mill	10	0,15
S380.108383	Salt mill	10	0,14

A 10 cm mini table model that is discreet and original. It offers a good grip with its flat lid and its polished shape. Steel pepper mechanism and stainless steel salt mechanism. Lifetime warranty.

Spices mill MAMBO 18 cm



Code	Designation	Hcm	Kg
	STEEL MECHANISM		
P284.188383	Pepper mill	20	0,3
S384.188383	Salt mill	20	0,34
	CERAMIC MECHANISM		
C284.188383	Pepper mill	20	0,3
C384.188383	Salt mill	20	0,34

An original baroque mill for the kitchen or table. It looks modern and light due to its transparency. Steel pepper mechanism and stainless steel salt mechanism. Steel mechanisms are lifetime warranty. Ceramic mechanism suitable for various spices. 4 grinding settings with the mill base.

Pepper/Salt mill LAMBADA 13 cm, steel mechanisms



Code	Designation	Hcm	Kg
P274.138383	Pepper mill	13	0,17
S374.138383	Salt mill	13	0,17

This fluid line model which is fully transparent, brings lightness and elegance to your table. A mill that also fits perfectly in the kitchen. Steel pepper mechanism and stainless steel salt mechanism. Lifetime warranty.



Pepper/Salt mill BOOGIE with crank chrome plated handle, steel mechanisms



Code	Designation	Hcm	Kg
P292.078382	Pepper mill	7	0,18
S392.078382	Salt mill	9,5	0,2

Due to its round shape like a ball and its handle, it is comfortable to use. It brings a touch of fantasy into the kitchen and on the table. Steel pepper mechanism and stainless steel salt mechanism. Lifetime warranty.



Spices mill BOOGIE with crank plastic handle



Code	Designation	Lcm	Wcm	Hcm	Kg
C292.078382	Pepper mill			7	0,18
C392.078382	Salt mill			7	0,2
C192.048382	Box of 4 spices mills 1 salt / 1 pepper / 1 herbs / 1 empty	28	7	9	0,77

Ceramic mechanism suitable for various spices. 4 grinding settings with the mill base.

Nutmeg mill TWIST



Code	Designation	Hcm	Kg
M516.118383	With handle	10	0,1
M516.108383	with stainless steel crank	10	0,13

Steel mechanism. This grinder allows finely and easily finely grated nutmeg. Particularly economical and efficient: the nut is completely shredded. Transparency brings modernity and elegance to the mill and allows to see the amount of nuts remaining.

Herbs mill ZOUK



Code	Designation	Hcm	Kg
C716.108383		10	0,11

Steel mechanism. A mill that is especially used for dried herbs, in particular herbs from Provence. The special stainless steel mechanism grates the herbs to reveal all their flavour. Practical and elegant in the kitchen and on the table. Essential for your marinades and grills.





The mills with a transparent acrylic body are filled with pepper or salt according to the model.

The acrylic body is useful to view the spices in the mill.

The top of the mill are made of chrome-plated ABS.

These mills are available with different mechanisms:

- With high quality cut and hardened steel mechanism for pepper mills.
- With stainless steel mechanism for salt mills.
- With a ceramic mechanism for spice mills; The adjustment of the mechanism of these models is made from the bottom and allows to get 4 different sets of grinding. The ceramic grinder is broadly used for any spice in the kitchen or on the table : all the peppers corns, white and sea salt, black salt from Hawaii, pink salt from Himalaya, dry herbs, caraway, poppy or sesame seeds ...

Pepper/Salt mill POLKA 11 cm, steel mechanisms



Code	Designation	Hcm	Kg
P286.118380 Pepper mill		11	0,12
S386.118380 Salt mill		11	0,12

A line with a traditional design that has been modernized by using a combination of transparent and stainless steel materials. The POLKA model comes in different sizes for the kitchen and the table. . Steel pepper mechanism and stainless steel salt mechanism. Lifetime warranty.

Spices mill POLKA 11 cm



Code	Designation	Hcm	Kg
C286.118380 Pepper mill		11	0,09
C386.118380 Salt mill		11	0,09

Ceramic mechanism suitable for various spices. 4 grinding settings with the mill base.

Pepper/Salt mill POLKA 14 cm, steel mechanisms



Code	Designation	Hcm	Kg
P287.148380 Pepper mill		14	0,2
S387.148380 Salt mill		14	0,22

A line with a traditional design that has been modernized by using a combination of transparent and stainless steel materials. The POLKA model comes in different sizes for the kitchen and the table. . Steel pepper mechanism and stainless steel salt mechanism. Lifetime warranty.

Spices mill POLKA 14 cm



Code	Designation	Hcm	Kg
C287.148380 Pepper mill		14	0,2
C387.148380 Salt mill		14	0,22

Ceramic mechanism suitable for various spices. 4 grinding settings with the mill base.

Spices mill SAMBA 18 cm



Code	Designation	Hcm	Kg
STEEL MECHANISM			
P284.188380	Pepper mill	20	0,3
S384.188380	Salt mill	20	0,34
CERAMIC MECHANISM			
C284.188380	Pepper mill	20	0,3
C384.188380	Salt mill	20	0,34

An original baroque mill for the kitchen or table. It looks modern and light due to its transparency.
 Steel pepper mechanism and stainless steel salt mechanism. Steel mechanisms are lifetime warranty.
 Ceramic mechanism suitable for various spices. 4 grinding settings with the mill base.

Pepper/Salt mill VOLTE 10 cm, steel mechanisms



Code	Designation	Hcm	Kg
P280.108380	Pepper mill	10	0,15
S380.108380	Salt mill	10	0,14

This is a discreet and original mini table model. It offers a good grip with its wide flat lid, its assertive base and its polished shape. Steel pepper mechanism and stainless steel salt mechanism. Lifetime warranty.

Pepper/Salt mill VOLTE 7 cm, steel mechanisms



Code	Designation	Hcm	Kg
P293.078380	Pepper mill	7	0,08
S393.078380	Salt mill	7	0,06

This is a discreet and original mini table model. It offers a good grip with its wide flat lid, its assertive base and its polished shape. Steel pepper mechanism and stainless steel salt mechanism. Lifetime warranty.

Salt shaker VOLTE 7 cm



Code	Designation	Hcm	Kg
M993.078380		7	0,05

Gift box Duo VOLTE 7 cm



Code	Designation	Lcm	Wcm	Hcm	Kg
M193.028380	Box with 2 mills Pepper & Salt	8,5	4	7	0,16
M993.028380	Box with Pepper mill & Salt shaker	8,5	4	7	0,16

This is a discreet and original mini table model. It offers a good grip with its wide flat lid, its assertive base and its polished shape. The 7 cm mini versions are perfect for tables for two.

Pepper/Salt mill SNOA 11 cm, steel mechanisms



Code	Designation	Hcm	Kg
P286.118080	Pepper mill	11	0,12
S386.118080	Salt mill	11	0,12

This mini table mill with a fluid line and its stainless steel look is suitable for modern tables. These mills are delivered empty.
 Steel pepper mechanism and stainless steel salt mechanism. Lifetime warranty.

Pepper/Salt mill ZUMBA 10 cm, steel mechanisms



Code	Designation	Hcm	Kg
P280.108080	Pepper mill	10	0,15
S380.108080	Salt mill	10	0,14

A discrete and original mini table model with its complete stainless steel look. It offers a good grip with its wide flat lid, its assertive base and its polished shape. It blends perfectly with stainless fixtures of the kitchen. Steel pepper mechanism and stainless steel salt mechanism. Lifetime warranty. These mills are delivered empty.

Pepper/Salt mill SALSA 13 cm, steel mechanisms



Code	Designation	Hcm	Kg
P274.138370	Pepper mill	13	0,17
S374.138370	Salt mill	13	0,17

The stainless steel, transparency and modern fluid line brings lightness and elegance to your table. This mill fits perfectly on the table as well as in the kitchen. Steel pepper mechanism and stainless steel salt mechanism. Lifetime warranty.

Spices mills KOLO with ceramic mechanism - 5 cm



Code	Designation	Lcm	Wcm	Hcm	Kg
C108.027070	Box with 2 mills Pepper & Salt	6,5	3	5,5	0,06

A 5 cm mini mill made of stainless steel and equipped with a real discreet. ceramic mechanism. A functional tool that is really elegant and

Stainless steel chocolate mill BAÏAO



Code	Designation	Hcm	Kg
M090.108370		10	0,17

This is an exclusive creation for making chocolate chips as well as parmesan. It is solid and effective with its special stainless steel mechanism. The handle makes it easy to use.



PRECISE SLICING WITH THE MANDOLINE

The first mandoline enjoyed great success, for being an innovative product (item, tool) that was quick, precise, easy-to-use, durable (lasting) and safe. All the following conceived mandolines stuck to these essential production criteria. De Buyer mandolines have the “Origine France Garantie” label.

- 107 -

Mini slicer KOMI
Slicer KOBRA

- 110 -

Mandoline SWING PLUS

- 112 -

Mandoline REVOLUTION

- 114 -

Mandoline VIPER
Mandoline VANTAGE

- 117 -

Mandoline ACCESS

- 118 -

Corer, tomato slicer





Mini vegetable slicer KOMI

new
2019



Code	Designation	Lcm	Wcm	Hcm
2018.00	Complete vegetable cutter with food guard and 2 Julienne blades 2/4 mm	27	11,2	3,3

Accurate and efficient: sharp blade with its 35°-angle.
 Multicut: slices & Julienne 2 mm/4 mm (0.08/0.15 in.).
 Quick and easy thickness adjustment.
 Graduated from 0 up to 5 mm.
 Equipped with an ergonomic protective food guard made of transparent plastic.
 Compact storage: integrated Julienne blades storage box & food guard.





KOBRA V AXIS

"Click Express" system

adjusts the thickness setting quickly, safely and efficiently

Cuts slices from extra-fine up to 5mm thick



KOBRA V AXIS : Professional fruit and vegetable slicer with pusher



Code	Designation	Lcm	Wcm	Hcm	Kg
2011.01	Complete with pusher - Black	36,5	12,2	8	0,66
2011.21	Complete with pusher - Green	36,5	12,2	8	0,66
2011.41	Complete with pusher - Red	36,5	12,2	8	0,66

SPARE PARTS :

2011.55	Pusher alone
---------	--------------



- V-shaped blade: the blade penetrates the product easily.
- Optimised cutting angle at 19,3°. Cuts easily and perfectly all fruits and vegetables, even the softest ones (tomatoes, pears, etc.).
- Micro-serration of the blade enables the thinnest cut of fruit/vegetable with skin and preserves their flesh composition.
- PRACTICAL & EASY: easy to adjust the height of the cut: the thumb wheel integrated at the end of the handle allows the adjustment of the thickness up to 5 mm. - St/steel ramp
- COMPACT: the pusher clips on for easy storage.
- SAFE Protective pusher. Silicone moulded anti-sliding ergonomic handle. Anti-skid feet.



SLICING KIT

GRAVITY

A GUIDE FOR CUTTING
 LONG VEGETABLES - SMALL VEGETABLES
QUICKLY, EFFORTLESS
WASTE FREE AND SAFELY

fits on the slider of DE BUYER 's mandolines (not for Kobra slicer)

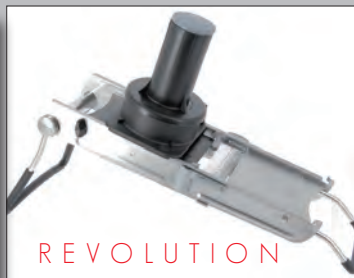

examples



LONG VEGETABLES



cucumber, carrot, zucchini, long radish...

STRAIGHT OR *
 CRINKLED SLICES



SMALL FRUITS & VEGETABLES



cherry tomato, shallot, radish, mushroom...



2015.84 Kit Gravity
 with tube slider and grey insert
 (delivered without mandoline)



BV Cert. 6054661



LA MANDOLINE SWING PLUS



ROBUST AND PROFESSIONAL : Mandoline made of stainless steel and polymer composite.
COMPACT - Easy to handle - Double-blades system : one single accessory for 2 uses. Folding upper foot for storage.
PRACTICAL : Easy inserting of the blades on the side and easy thickness adjustment mechanism.
EFFICIENT : Easy and precise cut. **SAFE :** Ergonomic pusher for maximum safety - Non-skid feet
MULTICUTS : Includes double horizontal blades (straight and serrated) and Julienne blades (space 4 and 10 mm) to produce many cut styles : Julienne cuts, waffle cut, slice or crinkle cuts. Precise thickness adjustment until 10-mm.

Code	Designation	Lcm	Wcm	Kg
2015.03	Complete mandoline with polymer composite Delivered with a double horizontal blade blade (straight & serrated) and a double Julienne blade (space 4 and 10 mm) Black colour New model : - Easy thickness adjustment - Lobed-edge horizontal blade - Ergonomic pusher	40	20	1,19
2015.23	Green colour	40	20	1,19
2015.33	Orange colour	40	20	1,19
2015.43	Red colour	40	20	1,19



Replacement parts for SWING PLUS : pusher and slider



Code	Designation	Kg
2015.59	Plastic pusher	0,22
2015.90	Slider for 2015.59	0,6

Large capacity of the receptacle: more products are cut at a single time. Ergonomic pusher for maximum safety

Replacement parts for LA MANDOLINE SWING PLUS



Code	Designation	Lcm	Wcm	Th.mm	Kg
2015.92	Double Julienne blade - 4 and 10 mm				0,26
2015.93	Double Julienne blade - 2 and 7 mm with storage box for both Julienne blades				0,09
2015.95	Double horizontal blades - with lobed edge	15,5	4	0,5	0,03

Easy and precise cut thanks to the blades made of high-quality stainless steel. Double-blades system -one single accessory for 2 uses- : - Straight blade and serrated blade - Julienne blade 4/10 mm and Julienne blade 2/7 mm

Slicing kit GRAVITY



Code	Designation	Øcm	Wcm	Hcm	Kg
2015.84		5	10,5	14,5	0,18
	See page 109				

A GUIDE FOR CUTTING LONG VEGETABLES & SMALL VEGETABLES QUICKLY, EFFORTLESSLY, WASTE FREE AND SAFELY.
It fits on the slider of DE BUYER's mandolines



BV Cert. 6054661



La Mandoline REVOLUTION



Multi-cuts : cubes, losanges, slices, crinkle cuts, Julienne cuts, waffle cuts.
 Thickness from ultrafine slices to one-centimeter.
 Professional: made of foodgrade st/steel and polymer composites. Satin polished st/steel.
 Horizontal double-blade made of high-quality cutlery st/steel. Julienne blades made of heavy duty professional st/steel.
 SECURE with its protective pusher. Easy to handle.
 Integrated dice system

Code	Designation	Lcm	Wcm	Hcm	Kg
2012.01	Complete Mandoline with receptable & pusher with 1 double horizontal blade-straight/serrated and 3 Julienne blades 2-4-10 mm	39,5	19,5	14	1,54
	STAINLESS STEEL PUSHER				
	with rotating control system				

La Mandoline REVOLUTION MASTER with stainless steel pusher



Code	Designation	Lcm	Wcm	Hcm	Kg
2012.41	Complete Mandoline with receptacle & pusher	39,5	19,5	14	2,38
	ULTRA 2.0 MASTER version with :				
	STAINLESS STEEL PUSHER				
	with rotating control system				
	- 6 Julienne blades 2-3-4-5-7-10 mm				
	in their removable storage box				
	- EXTRA-LONG PUSHER				
	- Special coated upper plate				
	- Double horizontal blade - lobe edged				
	- Upper foot with cap				

Same features as the standard model. Improved design and optimum efficiency.

Supplied with the st/steel round pusher and with one plastic extra-long pusher for long products.

6 Julienne blades 2-3-4-5-7 and 10 mm in their storage box

The upper foot is reinforced with st/steel 2 caps.

Improved slide with the special « pro-slide » coating on the upper plate.

Slicing kit GRAVITY



Code	Designation	Øcm	Wcm	Hcm	Kg
2015.84	See page 109	5	10,5	14,5	0,18

A GUIDE FOR CUTTING LONG VEGETABLES & SMALL VEGETABLES QUICKLY, EFFORTLESSLY, WASTE FREE AND SAFELY.

It fits on the slider of DE BUYER's mandolines

La Mandoline REVOLUTION : Replacement parts



Code	Designation	Lcm	Wcm	Th.mm	Kg
2015.95	Double horizontal blades - with lobed edge	15,5	4	0,5	0,03
	JULIENNE blades :				
2012.91	JULIENNE 2 mm - black				0,02
2012.92	JULIENNE 4 mm - red				0,02
2012.93	JULIENNE 10 mm - grey				0,02
2012.94	JULIENNE 3 mm - green				0,02
2012.95	JULIENNE 5 mm - blue				0,02
2012.96	JULIENNE 7 mm - orange				0,02
2012.88	Support for 3 Julienne blades (empty) For Mandoline REVOLUTION standard				0,04
2012.89	Storage box for 7 blades - delivered empty				

La Mandoline REVOLUTION : Replacement parts



Code	Designation	Lcm	Wcm	Kg
2012.56	Rotating control system (slider and pusher) Slider + st/steel pusher			
2012.55	Long pusher + slider Suitable for the standard Mandoline			0,24
2000.97	Small lower foot/stand For REVOLUTION & REVOLUTION MASTER	12	11,5	0,12
2012.98	Upper foot REVOLUTION MASTER			
2000.89	Set of 2 tightening knobs			



VIPER Mandoline



Code	Designation	Lcm	Wcm	Hcm	Kg
2016.00	Complete Mandoline with receptacle & pusher with horizontale blade & 2 Julienne 4 -10 mm	44	18,5	15	1,36

Frame with integrated V-shaped horizontal blade for accurate and easy cutting of all fruits/vegetable.
 Adjustable slice plate - Thickness from 1 to 8 mm.
 Knob for fast and precise thickness setting.
 Two julienne plates - 4 and 10 mm - and their storage box.
 Large receptacle for vegetables/fruits.

Secure with the ergonomic pusher and slider.
 Equipped with rotation control system to cut dices and diamonds easily.
 Compact with its folding rear foot.



Slicing kit GRAVITY



Code	Designation	Øcm	Wcm	Hcm	Kg
2015.84	See page 109	5	10,5	14,5	0,18

A GUIDE FOR CUTTING LONG VEGETABLES & SMALL VEGETABLES
QUICKLY, EFFORTLESSLY, WASTE FREE AND SAFELY.
It fits on the slider of DE BUYER 's mandolines

La Mandoline VIPER: Replacements parts



Code	Designation	Lcm	Wcm	Hcm	Kg
2016.96	Horizontal plate for slices	26	12	0,09	0,18
2016.92	Plate Julienne 4 mm	13,2	9,5	0,12	0,11
2016.94	Plate Julienne 10 mm	14,5	10,8	0,05	0,12

La Mandoline VIPER : Replacement parts



Code	Designation	Lcm	Wcm	Hcm	Kg
2016.59	Ergonomic plastic protective pusher	25,2	12	17,5	0,12
2016.90	Plastic slider	26	12	2,5	0,55



La Mandoline VANTAGE - standard model



Code	Designation	Lcm	Wcm	Hcm	Kg
2017.00	Complete Mandoline with slider and pusher - Integrated V-shaped blade - 4 Julienne blades 2-4-7-10 mm - V-shaped blade guard for storage - Storage box for accessories - EXTRA-LONG PUSHER	50	15	20	1,83

V-shaped blade to cut all types of fruit/vegetable even the softest. Total safety thanks to the ergonomic pusher and the slider.
 Stainless steel frame : robust and resistant.
 Equipped with 4 V-shaped Julienne blades
 Minimum space - Folding foot.



Slicing kit GRAVITY



Code	Designation	Øcm	Wcm	Hcm	Kg
2015.84	See page 109 A GUIDE FOR CUTTING LONG VEGETABLES & SMALL VEGETABLES QUICKLY, EFFORTLESSLY, WASTE FREE AND SAFELY.	5	10,5	14,5	0,18

It fits on the slider of DE BUYER's mandolines

La Mandoline VANTAGE - Replacement parts 2017.00



Code	Designation	Lcm	Wcm	Hcm	Kg
2017.91	Julienne 2 mm cut - 41 teeth				0,03
2017.92	Julienne 4 mm cut - 22 teeth				0,03
2017.93	Julienne 7 mm - 14 teeth				0,03
2017.94	Julienne 10 mm - 10 teeth				0,03
2017.89	Plastic storage box (empty)				0,27
2017.59	Pusher				0,13
2017.90	Slider				0,05
2017.86	V-blade guard				0,01
2017.55	Extra long pusher and slider	17,2	13	6,8	0,27

LA MANDOLINE ACCESS Stainless steel

new
2019

La Mandoline
ACCESS



BVCCnt. 6054661



ROBUST AND PROFESSIONAL : Mandoline made of stainless steel

COMPACT - Easy to handle - Double-blades system : one single accessory for 2 uses.

Folding upper foot for storage.

PRACTICAL : Easy inserting of the blades on the side and easy thickness adjustment mechanism.

EFFICIENT : Easy and precise cut.

SAFE : Ergonomic pusher for maximum safety

Non-skid feet.

MULTICUTS : Includes double horizontal blades (straight and serrated) and Julienne blades (space 4 and 10 mm) to produce many cut styles : Julienne cuts, waffle cut, slice or crinkle cuts. Precise thickness adjustment until 10-mm.

Code	Designation	Lcm	Wcm	Hcm	Kg
2014.00	Complete mandoline with polymer composite pusher Delivered with a double horizontal blade blade (straight & serrated) and a double Julienne blade (space 4 and 10 mm) - Easy thickness adjustment - Lobed-edge horizontal blade - Ergonomic pusher	44,5	18	23	1,45



Replacement parts for LA MANDOLINE ACCESS



Code	Designation	Lcm	Wcm	Th.mm	Kg
2015.92	Double Julienne blade - 4 and 10 mm				0,26
2015.93	Double Julienne blade - 2 and 7 mm with storage box for both Julienne blades				0,09
2015.95	Double horizontal blades - with lobed edge	15,5	4	0,5	0,03

Easy and precise cut thanks to the blades made of high-quality stainless steel. Double-blades system -one single accessory for 2 uses- :

- Straight blade and serrated blade
- Julienne blade 4/10 mm and Julienne blade 2/7 mm

Slicing kit GRAVITY



Code	Designation	Øcm	Wcm	Hcm	Kg
2015.84	See page 109	5	10,5	14,5	0,18

A GUIDE FOR CUTTING LONG VEGETABLES & SMALL VEGETABLES QUICKLY, EFFORTLESSLY, WASTE FREE AND SAFELY.
It fits on the slider of DE BUYER 's mandolines

Manual corer for fruits/vegetables - ø12 mm - Orange

Manual corer for fruits/vegetables - ø20mm - Green



Code	Designation	Øcm	Lcm	Kg
2612.01	L. tube 90 mm - Graduated	2,5	19,7	0,04

Code	Designation	Øcm	Lcm	Kg
2612.02	L. tube 112 mm - Graduated	3	24,6	0,08

Manual extractor that cores and tops and tails fruits/vegetables cleanly in a trice. Patented system. Universal: suitable for various fruits/vegetables. Multifunctions: removing stalk / Hollowing out / Stuffing. Overmoulded with TPE polypropylene ergonomic anti-slip handle with hole to hang; Stainless steel blade and graduated tube.



Manual universal corer for fruits / vegetables - ø30 mm - Red

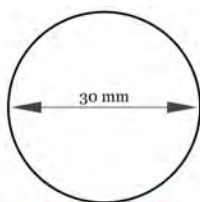

Code	Designation	Lcm	Wcm	Hcm	Kg
2612.03	L. tube 112 mm - Graduated	25			0,1

2612.12	Corer display Composition :	29	15	35	0,86
	- 6 Corers 2612.01				
	- 6 Corers 2612.02				
	- 6 Corers 2612.03				

Manual extractor that cores and tops and tails fruits/vegetables cleanly in a trice. Patented system. Universal : suitable for various fruits/vegetables. Multifunctions: removing stalk / Hollowing out / Stuffing.

Overmoulded with TPE polypropylene ergonomic anti-slip handle with hole to hang - Stainless steel blade and graduated tube.





Stainless steel tomato slicer, 5,5 mm thickness

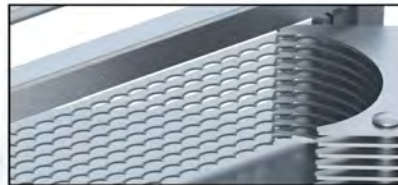

For 10 slices - 5,5 mm thick.

Serrated blades special for tomatoes. The horizontal cutting action avoids juice loss.

The tomato slicer lets you slice ripe tomatoes but also citrus fruits (lemons, oranges, kiwis,...). Suckers on the feet hold the slicer firmly in place on the worktop during use.

Safe: cover guards prevent anyone touching the blades. 2 ergonomic handles.

Made of all stainless steel: easy cleaning.

Code	Designation	Lcm	Wcm	Hcm	Kg
2005.00	Tomato slicer	42,5	20	18	5,5
2005.10	Set of replacement blades	24,5		7	0,14



de Buyer
MADE IN FRANCE
X50CrMoV15
182 21 cm





FRENCH-STYLE KNIVES

De Buyer has carefully analysed French and Japanese knife design. The findings were clear: Japanese knives have a perfect cutting edge while French knives are outstandingly solid. De Buyer chose to differ obviously by combining these two key elements when creating its two knife ranges.

- 122 -
Knives FIBRE KARBON 1

- 124 -
Knives FK2

-127 -
Sharpeners



FIBRE KARBON 1

FIBRE KARBON FEVER !

De Buyer created the Fibre Karbon 1 collection for the most demanding of professional chefs. The high tech handle, compression-moulded in France with multiple layers of carbon fibre, is light and extremely strong, making it perfectly balanced and pleasant to hold. Blades are very strong in the European tradition, and very sharp in the Japanese tradition – the perfect blend of both cutlery and culinary worlds.



CARBON FIBRE
MADE IN FRANCE
= LIGHT AND
EXTREMELY STRONG



ONE-PIECE
GERMAN X50CrMoV15
STAINLESS STEEL
= ROBUST AND DURABLE
HARD EDGE 56+/-2 HRC

MADE IN
FRANCE



Japanese knife with single-bevel blade- L. 26 cm



Code	Designation	Lcm	Wcm	Hcm	Kg
4270.26		41,5	1,85	6	0,46

Resulting from the fusion of a French Chef's knife to prepare meat and vegetables, and a Japanese single bevel sashimi knife for the finest of slicing.

Chef's knife FIBRE KARBON 1 - L. 22 cm



Code	Designation	Lcm	Wcm	Hcm	Kg
4271.22		36,5	1,86	6,1	0,35

Traditional strong French chef's blade for all regular heavy cutting work.

Japanese Chef's knife FIBRE KARBON 1 - L. 23 cm



Code	Designation	Lcm	Wcm	Hcm	Kg
4271.24		35,5	1,88	6,8	0,4

Like a traditional French Chef's blade, but more advanced : thinner and sharper cutting edge and scallops for less cutting effort, but strong for the toughest chef work.

Chef's knife SANTOKU FIBRE KARBON 1 - L. 19 cm



Code	Designation	Lcm	Wcm	Hcm	Kg
4271.19		33,5	1,85	5,5	0,6

The Santoku knife with scalloped blade is perfect for a broad range of uses: slicing, chopping, mincing of meat and vegetables.

Utility knife FIBRE KARBON 1 - L. 18 cm



Code	Designation	Lcm	Wcm	Hcm	Kg
4275.18		30	16,3	3,14	0,17

Between the small office knife and the chef knife, it is ideal for many small cutting tasks.

Paring knife FIBRE KARBON 1 - L.11 cm



Code	Designation	Lcm	Wcm	Hcm	Kg
4272.11		22,9	1,63	2	0,14

A high performance small utility knife or steak knife.

The knives FK2 are designed to be the ultimate blend of toughness, sharpness, functionality and value for real working chefs and serious gourmet cooks. In addition to the traditional blades expected, the FK2 range has many innovative blade shapes .



- **HARDNESS** : German X50CrMoV15 stainless steel alloy hardened and tempered to HRC56. Hard for edge retention and tough for edge durability
- **REBALANCE SYSTEM** : find your ideal balance with the innovative adjustable counterweight
- **UNIQUE BLADE GEOMETRY** : a fine grind between the thick German blades and light Japanese blades to bring strength and sharpness together
- **ROBUST HANDLE** : CARBON FIBRE COMPOSITE. Dynamic and ergonomic handle shape with texture grips strongly to resist hand slip
- **SOLID AND STRONG** : thick tang for long term durability. Solid one-piece bolster
- **Made in France**

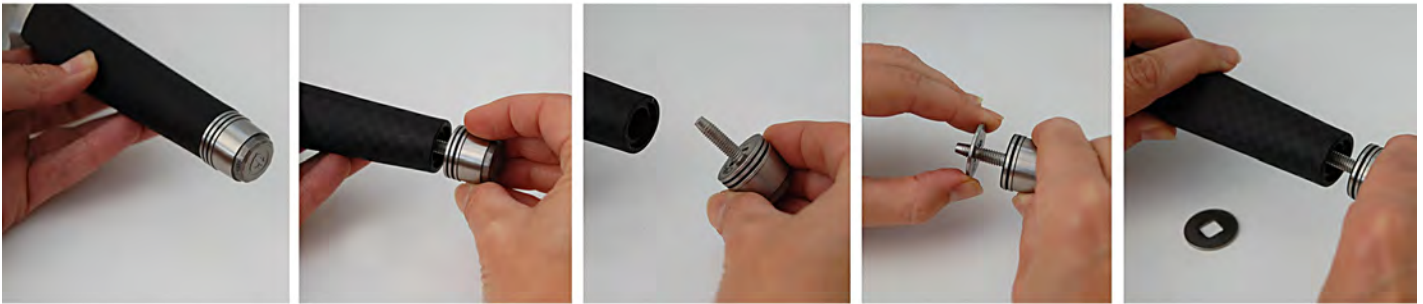

French Chef 's knife



This knife is the traditional French chef's knife for all heavy cutting work (vegetables, meat and fish).

Code	Designation	Lcm	Wcm	Hcm	Kg
4281.21	L. 21 cm	36	2,2	6	0,28
4281.26	L. 26 cm	41	2,2	6,5	0,35

Santoku knife L. 17 cm



Code	Designation	Lcm	Wcm	Hcm	Kg
4281.17		32,4	2,2	5,4	0,26

Good broad range of uses: slicing, chopping of meat and vegetables.

Asian Chef's knife



Code	Designation	Lcm	Wcm	Hcm	Kg
4280.15	L. 15 cm	28,6	4,9	2	0,16
4280.17	L. 17 cm	30	5,5	1,8	0,18

This 15cm Asian Chef's knife is very light and sharp and easy to maneuver for light quick cutting tasks in busy kitchens. It is also designed to be ideal for young cooks or for small hands.

Paring knife L. 9 cm



Code	Designation	Lcm	Wcm	Hcm	Kg
4282.09		21,7	2	2,3	0,12

Used by chefs for peeling, turning, and other small hand-held jobs.

Utility knife L. 14 cm



Code	Designation	Lcm	Wcm	Hcm	Kg
4285.14		26,7	2	3	0,14

Small chopping/slicing knife for many light meat/vegetable jobs for chefs and home cooks.

Precision carving knife with short and flexible Santoku blade L.16 cm



Code	Designation	Lcm	Wcm	Kg
4287.16		27,5	2	0,14

Ideally suited for carving thin slices from small pieces of meat and fish with perfect precision.

Salmon and ham knife Santoku 30 cm



Code	Designation	Lcm	Wcm	Th.mm
4287.30		42,5	2	2,6

Ultra flexible scalloped blade for cutting thin slices of bacon, ham or salmon.



Filet knife



Code	Designation	Lcm	Wcm	Hcm	Kg
4283.16	L. 16 cm	30,9	2,2	2,3	0,2
4283.18	L. 18 cm Perfect for Filet of Sole	28,5			0,14

This knife is perfect to for slicing fillets from fish and chicken. The blade is relatively long, narrow and flexible, for less slicing resistance.

Boning knife L.13 cm

Code	Designation	Lcm	Wcm	Hcm	Kg
4284.13		27,8	2,2	1,8	0,19



Specialty boning knife for chefs.

Carving Knife



Code	Designation	Lcm	Wcm	Hcm	Kg
4285.21	L. 21 cm	35,8	2	4	0,26
4285.26	L. 26 cm	40,6	2,2	4	0,28

Traditional western meat slicing blade (with sword tip). This knife is perfect for slicing large roasts, hams, etc. The blade is designed to offer the least resistance when slicing meat ,

allowing long cuts to be performed easily. It also slices cakes with ease.

Bread knife



Code	Designation	Lcm	Wcm	Hcm	Kg
4286.26	L. 26 cm	40,5	2,2	3,9	0,28

Bread knife with rounded tooth serration for longer blade life and smoother cutting. This type of serration also makes it a good 'bulk' or rough meat slicer.



High Tech Pro Knife sharpener 'DIAMOND CAMS'

DIAMOND CAMS™
PRO KNIFE SHARPENER



Resulting from many years of mechanical engineering R&D, the de Buyer 'DIAMOND CAMS' sharpener generates perfectly shaped and fine slightly convex edge bevels every time. Simply swipe any blade down and back through the highly engineered diamond-coated solid steel cams until the edge is razor sharp. Two stages in one: swipe light and shallow for everyday honing, and hard and deep for edge resharpening, including complete regrinding of old blades. More accurate than manual steel and stone methods because human error is eliminated with the accurate angle control of the sharpening/honing cams. Patents pending.

Code	Designation	Lcm	Wcm	Hcm	Kg
	SHARPENS AND HONES ANY KNIFE BRAND QUICKLY AND ACCURATELY				
4290.01	Professional 15°-20° fine convex	10,5	20	7,5	0,2

Pro 3-Stage Diamond Cams Blade Sharpener TRIUM

Code	Designation	Lcm	Wcm	Hcm	Kg
4290.02		12	6,7	5,7	0,33



The TRIUM Sharpener was developed to produce very sharp professional cutting edges on any brand of knife. The patent pending Diamond Cams control the edge angle very accurately as you swipe the blade down and back between the cams, for a highly refined cutting edge shape with a perfect hone ever time.

Professional steel QUINTUM 'Hypersteel'



Code	Designation	Lcm	Wcm	Kg
4291.00		45	3	0,32

The 5-stage professional sharpening and honing centre : the QUINTUM produces sharper knives in less time than traditional methods for better results for chefs and butchers, and easy pro results for home cooks : Diamond Cams in handle for full regrind of worn edges + 4 more stages of finer sharpening on steel shaft, 2 diamond and 2 hard chrome surfaces.

QUINTUM™





ESSENTIAL UTENSILS

From bowls to spatulas and whisks, De Buyer utensils are designed to work like natural extensions of your hand. They are ergonomic and comfortable to use. Especially noteworthy are our exclusive De Buyer piston funnels and “Le Tube” pressure pastry syringe, all with the “Origine France Garantie” label.

- 130 -

St/steel utensils for preparation
Automatic dispensers
LE TUBE

-140 -

Small utensils, whisks
& spatulas

- 154 -

Seafood utensils

- 156 -

Pizza accessories

- 158 -

Thermometers



Hemispherical bowl, round opened edge



Code	Designation	Øcm	Liters.	Th.mm	Kg
3372.16N		16	1	0,7	0,23
3372.20		20	2,1	0,7	0,35
3372.24		24	3,6	0,7	0,49
3372.30		30	7	0,7	0,7
3371.35		35	11,2	0,8	1,01
3371.40		40	16,8	0,8	1,35
Round stand for hemispherical bowl					
3379.00	For ø 20 - 24 cm			1	0,11
3379.01	For ø 30-35-40 cm			1	0,18

This stainless steel bowl, with its splayed skirt, owes its name to its round base. Its half-spherical form allows for the preparation to be well aerated during mixing, which is performed with downward movements. Inseparable from its whisk, the cul-de-poule is the ideal utensil for easily and rapidly making floating islands or emulsions.

- Professional stainless steel - Robust and undistortable
- Gloss polished outside & satin polished inside
- Hemispherical for a good ventilation of the preparation during mixing
- Open rim for perfect hygiene
- Rolled rim for handling without injury

Hemispherical pastry bowl, stainless steel and silicone



Code	Designation	Øcm	Liters.	Th.mm	Kg
3373.16		16	1	0,7	0,24
3373.20		20	2,1	0,7	0,37
3373.24		24	3,6	0,7	0,5
3373.30		30	7	0,7	0,73

De Buyer has developed a stainless steel, and never slips during use. The interior half-spherical « cul-de-poule » bowl, with a base covered in silicone. The bowl is stable and never slips during use. The interior graduations are also practical.

Hemispherical pastry bowl made of foodgrade polypropylene



Code	Designation	Øcm	Hcm	Liters.	Kg
4530.17		17,5	8	1	0,08
4530.23		23	10,5	2,5	0,16
4530.27		27,5	12	4,5	0,2
4530.32		32	14,5	6	0,26
4530.36		36	16	9	0,3
4530.40		40	18	13	0,4
4530.90	Set of 6 bowls from 1 L. to 13 L.				1,4

Flat bottom pastry bowl, round opened edge



Code	Designation	Øcm	Hcm	Liters.	Th.mm	Kg
3250.16		16	9	1	0,8	0,19
3250.20		20	10	2	0,8	0,24
3250.24		24	11,2	3,5	1	0,4
3250.28		28	12,5	5,5	1	0,56
3250.32		32	14	8	1	0,74
3250.36		36	15	11,5	1,2	1,1
3250.40		40	17,5	16	1,2	1,42
3250.44		44	19	20,5	1,2	1,63

Bowls for professional use, as much for their capacity as for the quality and thickness of the stainless steel used. They have an open rolled rim: rolled for handling without injury and open for

improved hygiene. Polished finish.

Stainless steel conical colander with base and 2 handles



Code	Designation	Øcm	Lcm	Hcm	Th.mm	Kg
3930.24		23,5	32	11,5	1	0,54
3930.32		29,4	39,5	14,4	1	0,8
3930.36		33	44,5	15,5	1,2	1,21
3930.40		36,5	49	17	1,2	1,47
3930.44		40	53,4	19	1,2	1,83
3930.48		44,6	58	19,3	1,2	2,14

This colander is made from 1.2mm (18 gauge) stainless steel, making it very robust and knock resistant. High quality.

Stainless steel colander - Professional quality



Code	Designation	Øcm	Lcm	Hcm	Th.mm	Kg
3232.24	Conical, 1 handle (1)	23,5	45	11	1	0,57
3232.28	Conical, 1 handle (1)	27	54	12	1	0,76
3240.24	-2	24	31,5	12	0,8	0,69

Colanders made from food-grade stainless steel. 3 different models are available. The colanders with a handle and a hook can be hitched onto the rim of a pan during straining.

Bakery chinese strainer, micro-perforated 0,8 mm



Code	Designation	Øcm	Hcm	Th.mm	Kg
3351.21	chinese strainer ø 21 cm	21	20,5	1	0,46
3351.23	chinese strainer ø 23 cm	23	22	1	0,56
3354.01	Non-slip stainless steel stand		15	6	0,17

Looking for all the world like its cousin the conical kitchen strainer, the stainless steel pastrycook's strainer has the added feature of micro perforations, making it as efficient as a muslin strainer but with several advantages: hygiene, toughness, and safety. This

conical strainer is professional-grade and extremely solid. Especially easy cleaning.

Kitchen Chinese strainer, heavy - Perforation 1,5 mm



Code	Designation	Øcm	Hcm	Th.mm	Kg
3350.10N		10	7,1	0,4	0,08
3350.14N		14	10,5	0,4	0,15
3350.18N		18,5	16	0,4	0,31
3350.20N		20	18	0,4	0,38
3350.23N		23	20,5	0,4	0,45
3350.26N		27	23	0,4	0,71
3354.01	Non-slip stainless steel stand		15	6	0,17

Range of different sizes made from heavy, extra-wear-resistant stainless. There is a hook opposite the handle to fit the conical strainer inside a pan. You can place the conical strainer on the

stand of a piston funnel to avoid spilling the contents.

Pusher for chinese strainer made of beechwood



Code	Designation	Lcm	Wcm	Kg
3350.90		25,5	5	0,19

Stainless steel frame muslin strainer - Twile mesh 0,4 mm



Code	Designation	Øcm	Lcm	Hcm	Th.mm	Kg
3352.20N		20	44	18	0,6	0,48
Handle thickness : 2 mm						
Reinforced with its ø 4mm st/steel wire to protect the mesh						

This strainer is fitted with a hook and a tongue enabling it to sit on round bowls. Hole mesh size: 0,4mm. It allows for the very fine filtration of gelatin, coulis or custard. 40 mesh.

Deep stainless steel frame muslin strainer - Twile mesh 0,4 mm



Code	Designation	Øcm	Lcm	Hcm	Kg
3352.22		22	45	23	0,57

Stainless steel sieve with 4 removable meshes

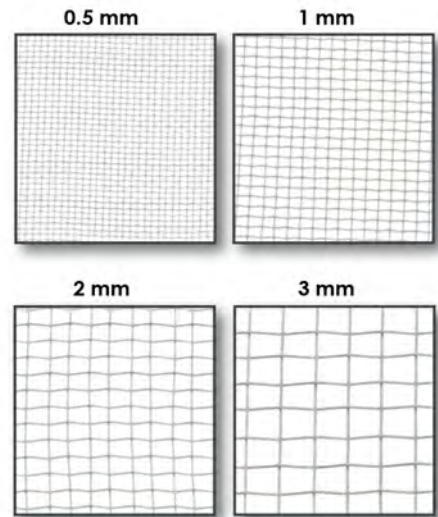

Code	Designation	Øcm	Kg
4605.21	mesh 3 mm/2 mm/1 mm/0,5 mm	20	0,37

- USES :
- Mesh 0.5 mm : flour, icing sugar
 - Mesh 1 mm : almond or hazelnut flour
 - Mesh 2 mm : purées, fish mousse
 - Mesh 3 mm (screen) : Peeling hazelnuts, chopped pralines mixes, marzipan grater

Stainless steel flour sieve with st/steel mesh N° 20 - mesh 0,8 mm



Code	Designation	Øcm	Hcm	Kg
4604.16		16	5,5	0,11
4604.21		21	6	0,19
4604.30		30	7	0,31

Strainer, st. steel



Code	Designation	Øcm	Lcm	Kg
	Mesh thickness 0,27 mm			
3242.10N		10	25,5	0,08
3242.12N		12	32,5	0,11
3242.14N		14	35	0,13
3242.16N		16	37	0,2
3242.18N		18	40	0,22

Perforated stainless steel strainer



Automatic dispenser by de Buyer

Filling, Pouring, Garnishing, decorating

	3353	3354.12	3354.02	3354.52	3358.01
Capacity	0,8 L.	1,5 L.	1,9 L.	3,3 L.	0,8 L.
Nozzle	Ø 7 mm 80°C max.	3 sizes: Ø 8 mm and nozzles Ø 4 & 6 mm	3 sizes: Ø 8 mm and nozzles Ø 4 & 6 mm	3 sizes: Ø 15 mm and 2 nozzles Ø 5 & 10 mm	2 nozzles supplied U8 & D8 Suitable for other nozzle forms
Use:					
	LIQUID FLUID	LIQUID	FLUID	LIQUID FLUID THICK MOUSSES	THICK COMPACT
Sweet or savory sauce	✓	✓	✓	✓	
Hot jelly		✓	✓	✓	
Hot fruit pulp		✓	✓	✓	
Cream Thick fruit coulis				✓	
Hot sirup		✓	✓	✓	
Liqueur	✓	✓	✓		
Mousse				✓	
Cake dough					✓
Mixture for Financiers Madeleines Cakes					✓
Jam				✓	
Puff pastry					✓
Chocolate pastry				✓	✓
Sponge biscuit					✓
Caramel chaud		✓	✓	✓	
Joconde biscuit				✓	
Custard					✓
White cheese Fruit compote				✓	

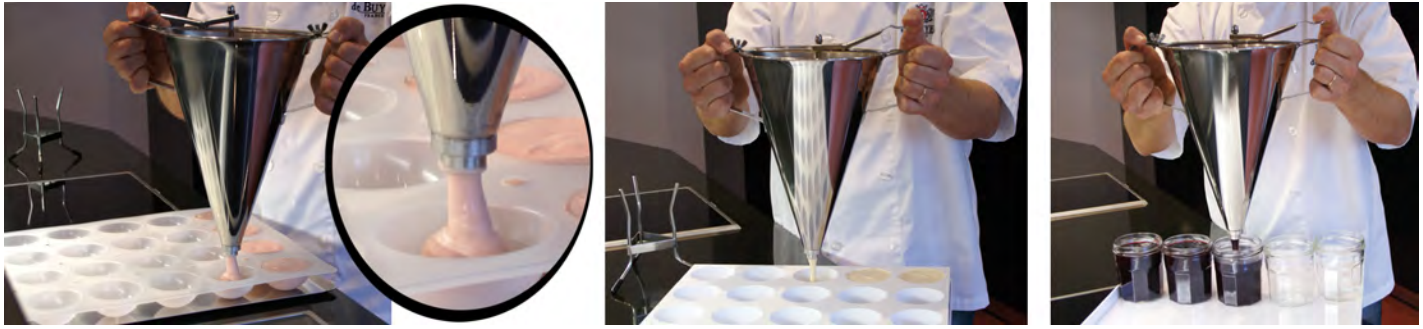

Automatic piston funnel KWIK MAX - 3,3 Liters - All stainless steel

Code	Designation	Øcm	Wcm	Hcm	Liters.	Kg
3354.52	with stand & 2 nozzles Professional model 3 sizes : ø 15 - 10 and 5 mm	20	30	38	3,3	0,95
SPARE PARTS :						
3354.51	Stand alone					
3354.79	Mechanism					



Big sizes of the integrated nozzle ø 15 mm to preserve air molecules of the preparations: saved smoothness.
Perfect for mousses, thick sauces, caramel, thick jelly or fruit coulis, etc.
All st/steel: suitable for very hot preparations.
The deep cone enables to push and pour naturally without pressure on the mixture.

Automatic piston funnel KWIK PRO, all stainless steel



Made entirely from stainless, including nuts, wing nuts, spring.. for perfect hygiene. Completely leakproof in the closed position: for creams, sauces, or liqueurs... Its ease of use makes it the universal kitchen and bakery tool for : - Garnishing plates with sauces, - Pouring jelly into a dish, - Filling small quiches, - Filling blini pans with batter, - Filling chocolate shells with liqueur, etc.

Code	Designation	Øcm	Hcm	Liters.	Th.mm	Kg
3354.00	Automatic piston funnel alone 1,9 L.	19	18	1,9	1	0,61
3354.02	Automatic piston funnel with stand 1,9 L.	19	18	1,9	1	0,78
3354.10	Automatic piston funnel alone 1,5 L.	17,5	16,5	1,5	1	0,55
3354.12	Automatic piston funnel with stand 1,5 L.	17,5	16,5	1,5	1	0,72
3354.01	Non-slip stainless steel stand		15		6	0,17
SPARE PARTS FOR FUNNEL :						
3354.92	Central closed nut					
3354.93	Wing nut					
3354.94	Spring					
3354.95	Set of two nozzles - 4 and 6 mm					
3354.89	Mechanism 1,5 L (piston, tie bar, lever, spring)					
3354.99	Mechanism 1,9 L (piston, tie bar, lever, spring)					



KWIK - Mini Piston funnel 0,8 liter - Stainless steel



Code	Designation	Øcm	Lcm	Wcm	Hcm	Liters.	Th.mm	Kg
3353.00	Black	15	18,5	15	15,5	0,8	0,4	0,25
3353.20	Green	15	18,5	15	15,5	0,8	0,4	0,25
3353.30	Orange	15	18,5	15	15,5	0,8	0,4	0,25
3353.40	Red	15	18,5	15	15,5	0,8	0,4	0,25
3353.60	Fushia	15	18,5	15	15,5	0,8	0,4	0,25

SPARE PARTS FOR FUNNEL :

- 3353.96 kit nozzle nut siphon
- 3353.95 Nozzle
- 3353.94 Spring

Stainless steel and plastic. Professional standard.
 This mini piston funnel comes with an outlet (7 mm dia. nozzle) and is completely impermeable.
 The funnel is practical and its low capacity (0.8 L) makes it ideal for dispensing small portions of sauce or cream, e.g. for garnishing dishes immediately prior to serving.
 Compact for practical storage.
 Dishwasher safe.

Stainless steel funnel for jam and to pour preparations in ring



Code	Designation	Kg
3356.00	2 parts for ø from 3,5 to 6 cm	0,23

This funnel is also practical to pour preparations in ring for arranging filling on a dish.





LE TUBE: Pressure pastry syringe for dosing of pastes, creams and mousses



Code	Designation	Lcm	Wcm	Liters.	Kg
3358.01	DESIGNED BY DE BUYER - PATENTED Delivered with 2 polycarbonate nozzles U8 (ø11 mm) & D8 + biscuits kit REF 3358.94	38,4	10,5	0,75	0,44
3358.92	ACCESSORIES Set of 2 lids for the tank				
3358.75	0,75 capacity extra tank + 2 caps ref.3358.92 for storing other preparations	19,6	8,54	0,75	0,13
DISPLAY WITH VIDEO including: - Boxes Le Tube 3358.01 - Sets of 6 Tritan nozzles - tanks 3358.75 Do not hesitate to ask us					
See other suitable nozzles TRITAN pages 207-211					

Pressure syringe for effortless dosing of paste, creams and mousses.
For garnishing, filling and decorating. Simple, fast and accurate work. Easier to fill than a pastry bag. 0,75 L. capacity in transparent plastic.
Graduated in cl and oz. Allows the user to see how much is left. Knob for easy setting of pressure for dosing the amount to be poured (from 1 to 5 cl).
Removable and interchangeable nozzles.



Special shortbread biscuits kit for LE TUBE

new 2019

Code	Designation	Kg
3358.94	Special lid disc holder + 13 discs + 2 caps ref.3358.92 to store the paste	0,17



Kit composed with a special lid (disc holder) and 13 removable decor discs.
Delivered with 2 caps ref. 3358.92
Fits on LE TUBE.



Box LE TUBE

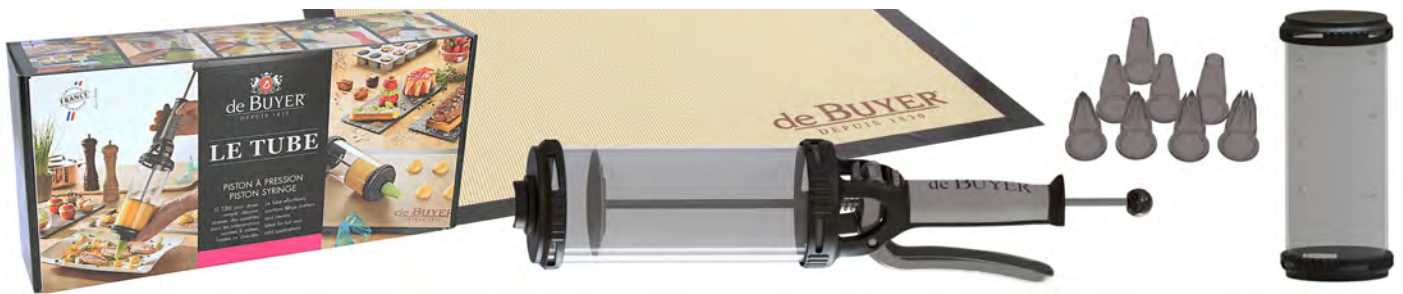

Code	Designation	Lcm	Wcm	Hcm	Kg
3358.30	This box includes : - Piston syringe LE TUBE - 1 extra container - 8 nozzles : 3 plain nozzles U6-U8-U12 / 1 St Honoré SH11 - 4 star nozzles B8-C8-D8-F8 - 1 silicone baking mat 40x30 cm	42,5	20,5	9	1

Funnel



Code	Designation	Øcm	Hcm	Kg
3357.12	Funnel with filter	11,6	12,9	0,13
3357.20	Funnel with filter	19,5	20,7	0,31
3356.12N	Funnel without filter	11,6	12,9	0,13
3356.20N	Funnel without filter	19,5	20,7	0,24
3357.01	All stainless-steel filter for funnel			0,02

This stainless steel funnel is available in two models, with filter (reference 3357) and without (reference 3356). The removable filter model ensures perfect hygiene. The filter fits inside funnel reference 3356

Dredger, stainless steel



Code	Designation	Øcm	Hcm	Liters.	Kg
4782.00N	Sugar dredger with metal mesh (1)	7	13	0,5	0,17
4782.01N	Sugar dredger with metal mesh	7	10	0,31	0,14
4783.00N	Sugar dredger - small holes ø1,5 mm (2)	7	13	0,5	0,17
4783.02N	Sugar dredger - small holes ø1,5 mm	7	10	0,31	0,14
4783.01N	Spices dredger - large holes (3) 2,5 mm	7	13	0,5	0,17
4783.03N	Spices dredger - large holes 2,5 mm	7	10	0,31	0,14

The perforated metal sprinkler is ideal for sprinkling with icing sugar. It comes with a bayonet-fitting top.

Dishes



Code	Designation	Lcm	Wcm	Hcm	Liters.	Th.mm	Kg	PU
3280.27	Flat-edge rectangular deep dish, conical	27	22	4	1,9	1	0,63	10
3280.30	Flat-edge rectangular deep dish, conical	30	25	4,3	2,6	1	0,79	10
3280.35	Flat-edge rectangular deep dish, conical	35	27	4,6	3,6	1	0,97	10
3280.40	Flat-edge rectangular deep dish, conical	42	32	5	4,9	1	1,24	5
3280.45	Flat-edge rectangular deep dish, conical	45	34	5	6,5	1,2	1,86	5

These stainless steel dishes are particularly resistant to knocks that happen during the course of handling. Besides this, they comply with professional dimensions.

Stainless steel professional food mill and sieves



Code	Designation	Øcm	Lcm	Hcm	Kg
2004.00N	Professional mill N° 5 without sieve	37	41	38,5	3,1
2004.10N	Sieve for N°5, ø 1 mm				
2004.15N	Sieve for N°5, ø 1,5 mm				
2004.20N	Sieve for N°5, ø 2 mm				
2004.30N	Sieve for N°5, ø 3 mm				
2004.40N	Sieve for N°5, ø 4 mm				
2007.00N	Semi-professional mill N° 3 delivered with 3 sieves 1,5mm - 2,5 mm - 4 mm	31			3

This professional stainless steel food mill lets you prepare puree, stewed fruit, fish soup, vegetable soup, etc. Three models of sieve fit onto it, each with different sized perforations.

Graduated bucket with base



Code	Designation	Øcm	Hcm	Liters.	Th.mm	Kg
3276.12N	Inner ø 29 cm	31	28,5	12	1,5	1,34
3276.15N	Inner ø 30,5 cm	32,5	32,5	15	1,5	1,51

Food-grade stainless steel bucket for holding any kind of food or liquid. Internal graduations every litre (except the 5 litre model).

Bucket without base



Code	Designation	Øcm	Hcm	Liters.	Th.mm	Kg
3274.10N	Grad. - inner ø 28 cm	30	24,5	10	1,5	1
3274.12N	Grad. - inner ø 29 cm	31	27	12	1,5	1,2

Food-grade stainless steel bucket for holding any kind of food or liquid. Internal graduations every litre (except the 7 litre model).

Measuring jug with foot, handle and with a spout



Code	Designation	Øcm	Hcm	Liters.	Th.mm	Kg
3565.05N		10	10,5	0,5	0,3	0,14
3565.10N		13,5	14	1	0,3	0,24
3565.15N		14	15	1,5	0,3	0,33
3565.20N		16	18,5	2	0,3	0,41
Small measuring jug with handle without foot						
3565.010N		6,8	4,5	0,1	0,2	0,03
3565.025N		8,5	7	0,25	0,2	0,07

This food-grade stainless steel measuring jug facilitates cooking and lets you measure liquids quickly. Easy to handle with its handle and pouring lip. Can be sterilized.

Set of 4 measuring cups: 60 - 80 - 125 - 250 ml



Code	Designation	Kg
4827.02	1/4 cup - 1/3 cup - 1/2 cup - 1 cup	0,4

Set of 4 measuring spoons : 1 / 2,5 / 5 / 15 ml



Code	Designation	Kg
4827.01	1/4 tsp - 1/2 tsp - 1 tsp - 1 tbsp	0,08

1/4 cup - 1/3 cup - 1/2 cup and 1 cup

Graduated measuring jug, polypropylene



Code	Designation	Hcm	Liters.	Kg
4021.05N		14	0,5	0,05
4021.10N		17	1	0,1
4021.20N		21,5	2	0,2
4021.30N		24	3	0,3
4021.50N		27	5	0,4

Graduated in litres and millilitres. Pouring lip and handle. Can be used from 0°C to 125 °C.

B BOIS utensils made of beechwood with a beeswax protective finishing.

The beech wood used is a PEFC certified wood coming from sustainably managed forests.

'B Bois' products are exclusively sold via physical retailers.



Rounded spatula B BOIS

**new
2019**



Bevelled spatula B BOIS

**new
2019**



Code	Designation	Lcm	Kg
4870.25		25	0,02
4870.30		30	0,03
4870.35		35	0,05
4870.40		40	0,07

Code	Designation	Lcm	Wcm	Hcm	Kg
4872.25		25	5	0,5	0,02
4872.30		30	5	0,5	0,02
4872.35		35	5,5	0,7	0,03
4872.40		40	6	0,7	0,05

Mixing spoon B BOIS

**new
2019**



Code	Designation	Lcm	Wcm	Hcm	Kg
4871.20		20	4,5	1,5	0,02
4871.25		25	4,5	1,5	0,02
4871.30		30	5	1,5	0,03
4871.35		35	5,5	1,5	0,05
4871.40		40	6	1,5	0,07

Pointed spoon B BOIS

**new
2019**



Code	Designation	Lcm	Wcm	Hcm	Kg
4874.00	Special sauce	30	5	1,5	0,04
4874.01	Special for risotto	30	5	1,5	0,03

Large spatula B BOIS

**new
2019**



Code	Designation	Lcm	Wcm	Hcm	Kg
4875.30		30	8	2	0,05

Crepe spatula B BOIS

**new
2019**



Code	Designation	Lcm	Wcm	Hcm	Kg
4873.00		30	4,5	0,5	0,02

Round crepe dough spreader B BOIS

**new
2019**



Crepe dough spreader B BOIS

**new
2019**



Code	Designation	Lcm	Wcm	Hcm	Kg
4873.01		20,5	16	1,5	0,01

Code	Designation	Lcm	Wcm	Hcm	Kg
4873.02		20	16	3	0,02

Set of 10 mini spatulas B BOIS

**new
2019**



Code	Designation	Lcm	Wcm	Kg
4873.04		14	4	0,08

Salad servers B BOIS

**new
2019**



Code	Designation	Lcm	Wcm	Hcm	Kg
4876.00		25	5,5	1,5	0,05

Toast tong B BOIS

**new
2019**



Code	Designation	Lcm	Wcm	Hcm	Kg
4876.01		21	5	3	0,03



Utensils B BOIS made of old time finishing stainless steel and wooden handle

new
2019



Code	Designation	Lcm	Wcm	Kg
2701.00	Slotted spoon	33,5	6,5	0,1
2701.01	Spoon	33,5	6,5	0,1
2701.02	Ladle	34	9	0,15
2701.03	Masher	29	7,5	0,14
2701.04	Skimmer	36,5	11	0,15
2701.05	Plain spatula	35	8	0,13

Beechwood handle with beeswax finish.

Utensils B BOIS made of old time finishing stainless steel and wooden handle

new
2019



Code	Designation	Lcm	Wcm	Kg
2701.06	Slotted spatula	35	8	0,11
2701.07	Flexible turner	30	8	0,07
2701.08	Cake server	27,5		0,07
2701.09	Spaghetti spoon	33	7	0,11
2701.10	Fork	32	3,5	0,08

Beechwood handle with beeswax finish.

Stainless steel one-piece ladle



Code	Designation	Øcm	Lcm	Hcm	Liters.	Th.mm	Kg
3021.06	L. Handle 28 cm	6	32,5	3	0,05	1,2	0,1
3021.08	L. Handle 28 cm	8	36	3,7	0,13	1,2	0,15
3021.10	L. Handle 32 cm	10	42	4,7	0,25	1,2	0,24
3021.12	L. Handle 35 cm	12	45	5,7	0,45	1,2	0,29
3021.14	L. Handle 43 cm	14	53	6,5	0,67	1,5	0,48
3021.16	L. Handle 43 cm	16	55,5	8	1	1,5	0,49
3021.18	L. Handle 43 cm	18	58	9	1,46	1,5	0,56
3021.20	L. Handle 51,5 cm	20	72	9,7	2,06	1,5	0,71

Single-piece ladles are manufactured in one piece, a guarantee of robustness. The handle is wide and very rigid; its ergonomic shape lets you insert your thumb. This stops the utensils from slipping

round even in greasy or sticky hands. This good handhold avoids a lot of fatigue. The slope of the handle suits all vessels, even deep ones.

Stainless steel one-piece skimmer



Code	Designation	Øcm	Lcm	Th.mm	Kg
3041.08	L. Handle 28 cm	8	34,5	1,2	0,1
3041.10	L. Handle 32 cm	10	41,3	1,2	0,14
3041.12	L. Handle 35 cm	12	44,5	1,2	0,18
3041.14	L. Handle 43 cm	14	53,5	1,2	0,26
3041.16	L. Handle 43 cm	16	55,5	1,2	0,31
3041.18	L. Handle 43 cm	18	57	1,5	0,39
3041.20	L. Handle 51,5 cm	20	67,5	1,5	0,48

Single-piece skimmers are manufactured in one piece, a guarantee of robustness. The handle is wide, very rigid, and ergonomically shaped. The skimmer lets you recover food that has risen to the

surface of the cooking liquid and strain it.

One-piece ladle with a spout



Code	Designation	Øcm	Lcm	Hcm	Liters.	Th.mm	Kg
3021.66	L. Handle 28 cm	6	32,5	2,8	0,05	1,2	0,1

Stainless steel. All the single-piece ladles are manufactured in one piece, a guarantee of robustness. The handle is wide, very rigid, and ergonomically shaped. Hard to get by without, the pouring ladle is

ideal for pouring sauce onto a plate or dish, for serving sangria or other drinks, etc. All without dripping.

Stainless steel one-piece basting spoon



Code	Designation	Lcm	Wcm	Th.mm	Kg
3982.10	STRAIGHT - L. Handle 28 cm	37	6,6	1,2	0,14
3983.10	SIDE - L. Handle 28 cm	36	6,4	1,2	0,14

The basting spoons are all manufactured in one piece. The handle is wide, very rigid, and ergonomically shaped. The spoons allow you to scoop up the juices from meat, fish, etc., and baste with them during cooking.

Stainless steel one-piece spatula



Code	Designation	Lcm	Wcm	Th.mm	Kg
3984.10	Perforated spatula L. Handle 35 cm	43,5	9,7	1,2	0,18
3984.12	L. Handle 37,5 cm	47	11,6	1,2	0,22
3985.10	Plain spatula L. Handle 35 cm	44	9,8	1,2	0,17
3985.12	L. Handle 37,5 cm	47	11,7	1,2	0,23

Single-piece spatulas are manufactured in one piece, a guarantee of robustness. The handle is wide and very rigid and its ergonomic shape lets you insert your thumb. This stops the utensils from slipping round even in greasy or sticky hands.

HEAVY DUTY UTENSILS

Stainless steel

Handle thickness = **2,5 mm** - Professional and robust

Ergonomic shape and multi-support hook

Diameter and/or liter engraved on the handle

Ladle - Heavy quality



Code	Designation	Øcm	Lcm	Liters.	Th.mm	Kg
3130.06	L. handle : 28,2 cm	6	33,5	0,05	2,5	0,14
3130.08	L. handle : 32,9 cm	8	39	0,13	2,5	0,22
3130.10	L. handle : 36,5 cm	10	44,5	0,25	2,5	0,31
3130.12	L. handle : 40,2 cm	12	50	0,45	3	0,45
3130.14	L. handle : 41,2 cm	14	52,5	0,67	3	0,55
3130.16	L. handle : 45,5 cm	16	58	1	3	0,68

Heavy duty stainless steel range. The handle is wide and very rigid; its ergonomic shape lets you insert your thumb. This stops the utensils from slipping round even in greasy or sticky hands. This good handhold avoids a lot of fatigue. The slope of the handle suits all vessels, even deep ones.

Skimmer



Code	Designation	Øcm	Lcm	Th.mm	Kg
3150.08	L. handle : 32,5 cm	8	40	2,5	0,2
3150.10	L. handle : 36,5 cm	10	45	2,5	0,25
3150.12	L. handle : 40,2 cm	12	50	3	0,36
3150.14	L. handle : 41,2 cm	14	53	3	0,43
3150.16	L. handle : 45,5 cm	16	58,5	3	0,51

Heavy duty stainless steel range. The handle is wide, very rigid, and ergonomically shaped. The skimmer lets you recover food that has risen to the surface of the cooking liquid and strain it.

Basting spoon



Code	Designation	Wcm	Liters.	Th.mm	Kg
3143.10	Straight - L. handle 36,5 cm	10	0,06	2,5	0,31
3144.10	Side - L. handle 36,5 cm	10	0,06	2,5	0,31

Heavy duty stainless steel range. The handle is wide, very rigid, and ergonomically shaped. The spoons allow you to scoop up the juices from meat, fish, etc., and baste with them during cooking.

Perforated one-piece spatula



Code	Designation	Wcm	Th.mm	Kg
3141.10	L. handle : 36,5 cm	10	2,5	0,31

Heavy duty stainless steel range. The handle is wide and very rigid and its ergonomic shape lets you insert your thumb. This stops the utensils from slipping round even in greasy or sticky hands.

Plain spatula



Code	Designation	Wcm	Th.mm	Kg
3142.10	L. handle : 36,5 cm	10	2,5	0,31

Heavy duty stainless steel range. The handle is wide and very rigid and its ergonomic shape lets you insert your thumb. This stops the utensils from slipping round even in greasy or sticky hands.

Meat fork



Code	Designation	Lcm	Wcm	Th.mm	Kg
3170.40	L. Handle 30 cm	38	4,5	1,5	0,17
3170.50	L. Handle 38 cm	48	4,5	1,5	0,21

Heavy duty range. Stainless steel. The grapplers are made from one piece, a guarantee of robustness. The handle is wide and very rigid and its ergonomic shape lets you insert your thumb. This stops the utensil from slipping round even in greasy or sticky hands.

Ladle



Code	Designation	Øcm	Lcm	Wcm	Liters.	Th.mm	Kg	PU
3136.08	Pizza ladle, flat bottom (1) L. Handle 28 cm	8,2	32		0,15	0,8	0,13	5
3135.00	Mini ladle, oval (2) L. Handle 22,5 cm - 2 cl	4,5	25	3		0,8	0,04	5
3135.04	Mini ladle, round (3) L. Handle 23,5 cm - 2 cl	4	25			0,8	0,04	5
3134.06	Fruit ladle with a spout(4) L. Handle 15,5 cm	6	20		0,05	0,8	0,75	5

Welded shank. The small pouring ladles are ideal for applying toppings or for serving sauces, liqueurs, etc. The small pizza ladle holds 145ml (4 fluid oz), which is the standard helping of tomato

sauce for pizzas; its flat bottom lets you spread the sauce over the pizza pastry.

Serving spoon



Code	Designation	Liters.	Kg
2140.00	Plain	33	0,08
2140.10	Perforated	33	0,08

Spatula for non-stick frypans



Code	Designation	Lcm	Wcm	Kg	PU
4813.01N		28	6,5	0,03	5

This flexible nylon spatula has rounded edges and is recommended for use with CHOC cooking utensils as it avoids damaging their non-stick coating. Heat resistant.

Butcher hook, stainless steel



Code	Designation	Lcm	Th.mm	Kg	PU
3010.12N	"S"	12	5	0,03	10

S-hook for hanging up meat. Also available with a 3-ring extension. Made from food-grade stainless steel.

Wall hanging bar for utensils



Code	Designation	Lcm	Wcm	Th.mm	Kg
3011.80		79	2,5	5	0,93

Fixes on the wall and allows hooked utensils (ladle, skimmer, spatula, etc.) to be hung up.

Wall hanging bar for utensils with 8 removable hooks - Stainless steel



Code	Designation	Lcm	Wcm	Th.mm	Kg
4720.00		44	2,4	2,5	0,36

Heavy duty 2.5-mm thick stainless steel : do not distort. Brushed stainless steel. Practical in order to have all utensils at hand. Sliding hooks allow an easier use. Suitable for both utensils equipped with a hook and utensils provided with a hanging hole.

Wire skimmer, extra-strong stainless steel



Code	Designation	Øcm	Lcm	Kg
2601.12N	L. Handle 34 cm	12	34	0,24
2601.14N	L. Handle 35 cm	14	48	0,27
2601.16N	L. Handle 36 cm	16	38	0,29
2601.18N	L. Handle 41,5 cm	18	56	0,35
2601.20N	L. Handle 43,5 cm	20		0,38
2601.22N	L. Handle 45 cm	22	64	0,41

The wire deep-fry skimmer lets you recover and strain food floating in the cooking liquid.

Grip for hot dishes or plates



Code	Designation	Lcm	Wcm	Kg	PU
3339.00N		19	3	0,15	5

These extra-sturdy pincers allow you to handle hot plates or dishes safely so as to avoid burns.



Spaghetti tong



Code	Designation	Lcm	Th.mm	Kg	PU
4816.21N		20	0,5	0,06	5

Spring tongs that enable spaghetti to be held cleanly during serving. These tongs are also suited to serving grated raw vegetables.

Utility tongs



Code	Designation	Lcm	Th.mm	Kg	PU
4788.24N		24	0,5	0,12	12
4788.30N		30	0,5	0,15	12
4788.40N		40	0,5	0,2	12

The large model is very practical for oven ranges, grills, barbecues...

Plastic utility tong



Code	Designation	Lcm	Kg
4789.00		30	0,13

Utility tong with silicone-coated ends. Perfect for using in nonstick pans.
Adjustable grip

Stainless steel tweezer with curved end



Code	Designation	Lcm	Kg
4239.15		16	0,02
4239.30		30	0,08
4239.35		35	0,17

Tweezer for picking up ingredients and easily handling them, from the thinnest one (herbs, flower, etc.) to the largest one (piece of meat).
For serving up and decorating plates.

Stainless steel straight tweezer



Code	Designation	Lcm	Kg
4238.15		16	0,02
4238.25	L. blade 25 cm	25,5	0,05
4238.30		30	0,08

Tweezer for picking up ingredients and easily handling them, from the thinnest one (herbs, flower, etc.) to the largest one (piece of meat).
For serving up and decorating plates.

Stainless steel curved tweezer



Code	Designation	Lcm	Kg
4237.20		20	0,03

Tweezer for picking up ingredients and easily handling them. For serving up and decorating plates.

Ice-cream scoop made of cast aluminium with eutectic handle system



Code	Designation	Lcm	Wcm	Kg	PU
4815.00N	Width of the bowl : 4,5 cm	18	4,5	0,11	5

Designed for a better productivity with its shape and the sharp edges. Equipped with a stop drop edge and a flat base : stable and practical. When gripped, the eutectic (thermoactive) handle spreads the warmth over the whole spoon as the scoops of ice-cream are being molded to shape. This allows

the scoops to be molded more easily. Waterproof. NOT dishwasher safe.

Ice-cream scoop - Stainless steel



Code	Designation	Øcm	Lcm	Liters.	Kg
4826.05N	Portion 80ml = 1/12,5 L	6,3	23,1	0,08	0,15
4826.04N	Portion 60ml = 1/16 L	5,8	22,5	0,06	0,15
4826.03N	Portion 40ml = 1/25 L	5	21,5	0,04	0,14

Flour scoop , polypropylene



Code	Designation	Lcm	Liters.	Kg
4370.02N		26	0,25	0,04
4370.05N		32	0,5	0,07
4370.09		39	0,9	0,12

This very practical measuring scoop is made from food-grade polypropylene.

Scoop, st. steel



Code	Designation	Lcm	Wcm	Hcm	Liters.	Th.mm	Kg
3271.20	Flour scoop, with handle 75 cl	20	12	5,5	0,75	1,5	0,41
3271.24	Flour scoop, with handle 1,4 L	24	15	6,5	1,4	1,5	0,53

These stainless steel scoops ensure perfect hygiene. The stainless tube handle is welded.

Omelette turner, stainless steel



Code	Designation	Lcm	Wcm	Th.mm	Kg
3294.30		30	28	1,2	0,79

This highly practical omelette spade is for use on snack-bar griddles.

Skewer, stainless steel



Code	Designation	Lcm	Th.mm	Kg
3401.25	Set of 10	25	2	0,01
3401.30	Set of 10	30	2	0,01
3401.35	Set of 10	35	2	0,01
3401.40	Set of 10	40	2	0,02

Available 25 to 40cm (8" to 12") long, these stainless skewers are made from 2mm (14 gauge) stainless steel and will not bend. The pointed end allows food to be skewered easily.

Rubber flexible scraping spatula

Code	Designation	Lcm	Kg
4891.24N	L. handle 18 cm	29	0,07
4891.34N	L. handle 24 cm	37,3	0,1
4891.42N	L. handle 30 cm	43	0,11



A must for pastrycooks, the "Maryse" spatula is flexible and enables containers of all shapes to be scraped out efficiently, recovering all the mixture. Maryse DE BUYER : Non-scratching utensil - Built-in hook to prevent slippage into bowls - Spoon-shaped blade ideal for scooping and spreading - Dishwasher safe - Maximum heat exposure 100°C (212°F).

One-piece spatula - high temperature (+260°C) - Nylon handle and silicone blade

Code	Designation	Lcm	Kg
4740.24N		27	0,08
4740.34N		36	0,11
4740.42N		42	0,13



This flexible spatula makes easy to remove sauces from hard-to-reach spots. Resists to +260°C / 500°F. Keeps out bacteria thanks to one piece construction: silicone blade and plastic handle are moulded together. Easy cleaning - Dishwasher safe.

White spatula made of polyglass - 220°C-resistant (470°F)

Code	Designation	Lcm	Kg	PU
4745.25		25	0,04	6
4745.30		30	0,05	6
4745.35		35	0,06	6
4745.40		40	0,08	6
4745.45		45	0,1	6
4745.50		50	0,12	6



Robust and hygienic thanks to the non-porous composite material "polyglass" (polyamid/ glass). The cleaning is easy (dishwasher safe) and the spatula can be sterilized. The rounded shape of the spatula - without edge - enables one to efficiently scrape out the pan. The end of the handle has a rim to prevent the spatula falling into the preparation.

The UNIVERSAL WHISK by DE BUYER

To Mix, Beat, Aerate, Emulsify...

The essential utensil for cooking and patisserie :
 the whisk de Buyer is available
 in 7 sizes for preparing :
 Sauces, emulsions, creams, dough, batter...

Göma
Fouet Universel

Stainless steel wires
 Spring quality
 Do not loosen
 from handle

Perfectly hygienic
 Can be sterilized

Hole :
 Easy to hang
 and to drain

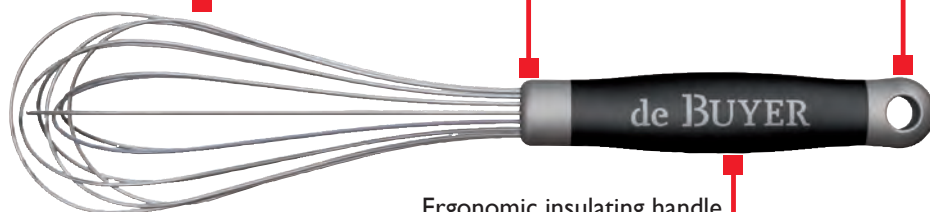

Ergonomic insulating handle



Anti-slip handle with curved design: the whisk will not fall into the pan.

HEAVY DUTY
PROFESSIONAL
ERGONOMIC

Overmoulding with TPE
 (Thermo Plastic Elastomer)



Polypropylene



2 possibilities
 to use the whisk



THE LINE

- 2610.20 Universal whisk with slim handle L. 20cm. Perfect for using in small pans for sauces.
- 2610.25 Universal whisk with slim handle L. 25cm
- 2610.30 Universal whisk with slim handle L. 30cm
- The handle of the smaller whisks L. 25 cm and 30 cm is different : Slimmer to ensure comfort for all as well as smaller hands.*
- 2610.35 Universal whisk L.35 cm
- 2610.40 Universal whisk L.40 cm
- 2610.45 Universal whisk L.45 cm
- 2610.50 Universal whisk L.50 cm
- EGG-WHITE ROUNDED WHISK :
- 2611.35 Universal whisk L.35 cm
- 2611.45 Universal whisk L.45 cm

PERFECT HYGIENE

Can be sterilized
 Dishwasher safe



For a standard domestic use
choose a maximum size L. 35 cm for whisks and spatulas

Professional whisk for cooking and patisserie



Code	Designation	Lcm	Wcm	Kg
2610.20	St/steel wire ø 1,4 mm	22,43	5	0,06
2610.25	St/steel wire ø 1,4 mm	26,5		0,08
2610.30	St/steel wire ø 1,8 mm	32		0,14
2610.35	St/steel wire ø 1,8 mm			0,6
2610.40	St/steel wire ø 1,8 mm	41,5		0,19
2610.45	St/steel wire ø 1,8 mm	46,5		0,23
2610.50	St/steel wire ø 1,8 mm	50		0,25

The essential utensil for cooking and patisserie : the professional whisk de Buyer with stainless steel wires -spring quality- Encased wires: perfectly hygienic and watertight. Ergonomic and anti-slip comfortable handle. Easy storage with its hole. Perfect hygiene : Can be sterilized - Perfectly watertight - Dishwasher safe

Egg-whites whisk GÖMA



Code	Designation	Lcm	Kg
2611.35	St/steel wire ø 2 mm	35	0,18
2611.45	St/steel wire ø 2 mm	45	0,23

This whisk has a large head and hard springy wires. It is specially designed for beating egg-whites until stiff.

Kitchen whisk, all st. steel



Code	Designation	Lcm	Th.mm	Kg
2604.20N	L. Handle 9 cm	20	1,5	0,07
2604.25N	L. Handle 10 cm	25	1,5	0,08
2604.30N	L. Handle 12 cm	30	2	0,14
2604.35N	L. Handle 13 cm	35	2	0,2
2604.40N	L. Handle 14 cm	40	2	0,22
2604.45N	L. Handle 16 cm	45	2	0,3
2604.50N	L. Handle 17 cm	50	2	0,32

Heavy duty all stainless steel whisk. Ideal for sauces and other preparations.

Spatula made of high quality stainless steel

Mirror polished blade :

- Easy spreading
- Avoids risk of rust - Dishwasher safe

High flexible blade

Thinned blade : more thin on the end for a better flexibility and a precise spreading work

Ergonomic handle

Robust and resistant made of polyamid reinforced with fiberglass
 Anti-slip carbon texture
 Slot for wedging the thumb + finger stopper for a good grip
 Integrated hook practical to hang the product



MADE IN FRANCE

Cranked pastry spatula FKOfficium



Code	Designation	Lcm	Wcm	Kg
4231.15	L. Blade 15 cm	33,5	3,5	0,12
4231.20	L. Blade 20 cm	38,5	3,5	0,13
4231.25	L. Blade 25 cm	43,5	3,5	0,15
4231.30	L. Blade 30 cm	48,5	3,5	0,16

With its angled handle, this spatula makes it easy to spread and level out pasty substances.



Straight pastry spatula FKOfficium

Code	Designation	Lcm	Wcm	Kg
4230.15	L. blade 15 cm	29	3,5	0,11
4230.20	L. blade 20 cm	34	3,5	0,12
4230.25	L. blade 25 cm	39	3,5	0,13
4230.30	L. blade 30 cm	44	3,5	0,14



This flat spatula has a rounded end and is ideal for spreading, smoothing, and handling pastries.

Mini cranked pastry spatula FKOfficium

Code	Designation	Lcm	Wcm	Kg
4231.08	Pointed blade 8 cm	21	2	0,04
4231.09	Rounded blade 9 cm	22	2	0,04
4231.12	Rounded blade 12 cm	25	2,4	0,05



Stainless steel flexible turner FKOfficium

Code	Designation	Lcm	Wcm	Kg
4235.00	L.blade 17 cm	31	7,8	0,1



This food turner is made from forged stainless steel. Its springiness makes food easy to handle and turn.

Triangular spatula FKOfficium

Code	Designation	Lcm	Wcm	Kg
4233.01	L. blade 8 cm	26,5	8	0,11



With its special shape, this spatula lets you clean grids and hotplates. Its width and sharp angles also allow you to cut or spread pasty substances or to peel chocolates off their baking sheets.

Cranked spatola FKOfficium inox

Code	Designation	Lcm	Wcm	Kg
4232.00	L. blade 12 cm	30	9	0,14
4232.01	Slotted - L. blade 12 cm	30	9	0,12



With its angled handle and rigid blade, this spatula lets you scoop up and turn over hamburger steaks and other meats on snack-bar griddles.

Cranked service spatula FKOfficium

Code	Designation	Lcm	Wcm	Kg
4236.00		26,5	5	0,07
4236.01	Slotted	26,5	5	0,06



Genoise cutter FKOfficium

Code	Designation	Lcm	Wcm	Th.mm	Kg
4234.25	L. blade 25 cm	39,5	3,5	2	0,14
4234.35	L. blade 35 cm	50	3,5	2	0,16



The sponge-cake slicer lets you slice sideways through sponge cakes evenly, without crumbs, so you can then fill the cake with cream or other fillings.



Seafood box



Code	Designation	Lcm	Wcm	Hcm	Kg
4683.90	Box includes : - seafood shears - 4 double seafood forks - an oyster knife	30	20	3,5	0,42

The essential seafood tools gathered in a practical and elegant box.

Seafood shears with stainless steel blades



Code	Designation	Lcm	Wcm	Th.mm	Kg
4685.00		20,7	6,5	1,5	0,11

LOCK-AND-SPRING MECHANISM FOR A STRESS-FREE AND SAFE CUT.
Cut hard shellfish leaving meat intact, without cracking nor mess. Ideal for lobster, crab, langouste, shrimp and scampi. Patented.
Large handle - Good grip for all hands. Integrated grip.
Detachable stainless steel blades for easy cleaning.

Set of 4 stainless steel double lobster forks

Code	Designation	Lcm	Wcm	Kg	
4687.00	Set of 4 forks	21	1,8	0,01	



DOUBLE FORK : Small and large end to easily remove meat from shellfish.
 Ideal for lobster, crab and langouste.
 Ergonomic design for good grip.
 Robust stainless steel - Dishwasher safe

Oyster knife with stainless steel blade

Code	Designation	Lcm	Wcm	Hcm	Kg
4683.00		15,7	4,5	2	0,06



Short and sharp blade made of extra hard stainless steel 420 2CR14.
 Perfectly sharp blade to easily cut the muscle of the oyster.
 Polyamide handle with fiberglass. Resistant and non-slip. Length adapted to all hands.

Ergonomic safe handle with slot for thumb and stopper.
 Handwash recommended - Dishwasher safe

Protection oyster mitt

Code	Designation	Lcm	Wcm	Hcm	Kg
	Extra large model - silicone				
4682.20	For right-handed Mitt on the left hand	23	17	2	0,14
4682.21	For left-handed Mitt on the right hand	23	17	2	0,14



This oyster mitt allows to maintain the oyster during opening. It can not provide a total protection against a misdirected knife. The extra arge model is suitable for the largest handles.



Stainless steel pizza ladle - Flat bottom



Code	Designation	Øcm	Lcm	Liters.	Th.mm	Kg	PU
3136.08	Pizza ladle, flat bottom (1) L. Handle 28 cm	8,2	32	0,15	0,8	0,13	5

Welded shank. The small pizza ladle holds 145ml (4 fluid oz) , which is the standard helping of tomato sauce for pizzas ø 31 cm; its flat bottom lets you spread the sauce over the pizza pastry.

Pizza cutting wheel



Code	Designation	Øcm	Th.mm	Kg
4970.10N	Pizza cutting wheel	10	1	0,17

This particularly sturdy pizza cutter has an ergonomic handle for a firm grip. Its stainless steel beveled blade allows pizza to be easily cut into portions.

Perforated pizza screen for cooking - aluminium



Code	Designation	Øcm	Kg
7350.23		23	0,06
7350.28		28	0,07
7350.31		31	0,09
7350.33		33	0,1
7350.38		38	0,14
7350.43		43	0,15
7350.48		48	0,21

Perfect for making pizzas, flammenkuche savory tarts, etc. The bottom is perforated to enable you to obtain a crusty-baked pie bottom.

See our complete range of round pizza trays page 174

Pizza round oven peel - Aluminium with wooden handle



Oven peel for pizza or "Flammenküche"



Code	Designation	Øcm	Lcm	Kg
7291.40	L. handle 120 cm Total length : 162 cm	40	162	0,93

Code	Designation	Lcm	Wcm	Th.mm	Kg
3293.31	Pizza square oven peel L. Handle 96 cm	128	31	1,2	1,35

3294.46	Rectangular oven peel L. Handle 95 cm	141	36	1,2	1,45
---------	--	-----	----	-----	------

The food-grade stainless steel rectangular oven spades are especially rugged and will not distort. The shank is made from round tube and its long length lets you stuff pizzas right into the heart of the oven.

Pizza square oven peel - Aluminium with wooden handle



Code	Designation	Lcm	Th.mm	Kg
7293.31	L. handle 120 cm Total L. 152,5 cm	31	1,5	0,89



Pizza oven peels

Code	Designation	Øcm	Lcm	Th.mm	Kg
3290.31	Pizza oven peel - L. Handle 96 cm	31	114	1,2	1,18



The stainless steel handle is made from round tubes and their long length lets you stuff pizzas right into the heart of the oven.

Scraper brush for oven, wooden handle



Code	Designation	Lcm	Wcm	Hcm	Kg
4875.70		71	11,5	5	0,28

The scraper brush is used for brushing the hearth and pushing back the embers in your wood-fired oven.

Small syrup density meter, metric

Code	Designation	Lcm	Kg
4591.00N	Grad. from 1100 to 1400 g/L	14	0,19



This professional syrup hydrometer is used for making jam, jelly, liqueur, sorbey, chutney, conserved fruits, etc. It has 2 scales : one in degree baumé (15-40° Baumé) and the other in g./ml (1100-1400 g./ml).

Mini precision balance with lid - from 0 to 500 gr.

Code	Designation	Lcm	Wcm	Th.mm	Kg
4887.00		11,5	6,4	1,8	0,13



Accurate scale with lid. Precision 0.1 gr.
Perfect for spices.
Fonction tare and auto-off.
2 batteries 1,5V supplied

Candy thermometer +80°C / +200°C with stainless steel case

Candy thermometer +80°C / +200°C with nylon case



Code	Designation	Øcm	Lcm	Kg
4884.01N	PRECISION 1/1	0,2	27,5	0,1

Code	Designation	Øcm	Lcm	Kg
4884.00N	PRECISION 1/1	0,35	27,5	0,07

This thermometer is used for pastry and candy. It does not contain mercury, but a less toxic red liquid. It is calibrated to allow for immersion of the lower thinner part of the stem. The protective sleeve can be sterilized at 100°C.

The thermometer and sleeve can be washed in a dishwasher.

This thermometer is used for pastry and candy. It does not contain mercury, but a less toxic red liquid. It is calibrated to allow for immersion of the lower thinner part of the stem. The protective sleeve can be sterilized at 100°C. The thermometer and

sleeve can be washed in a dishwasher.

Bakery thermometer -10°C / +60°C with polypropylene case

Code	Designation	Øcm	Lcm	Wcm	Kg
4886.00N	PRECISION 1/1 Polypropylene case	0,16	23,5	1,6	0,04



This thermometer is used for bakery. It does not contain mercury, but a less toxic red liquid. It is calibrated to allow for immersion of the lower thinner part of the stem. The protective sleeve can be sterilized at 100°C. The thermometer and sleeve can be washed in a dishwasher.

Stainless steel oven thermometer - precision from +50°C to + 300 °C



Code	Designation	Wcm	Hcm	Kg
4885.01	Precision 1/1	6	7	0,54

To check the temperature in the oven during cooking. Easy cleaning with water and soap.

Small plastic thermometer - from - 40°C to 40°C



Code	Designation	Lcm	Wcm	Hcm	Kg
4761.00N	From -40°C to +50°C	13,5	2,4	0,13	0,01

This metric thermometer goes from -40°C to +40°C and is specially adapted for the cold. The thermometer has an all-plastic body. The column is very visible.

Electronic cooking digital thermometer-timer



Code	Designation	Lcm	Wcm	Hcm	Th.mm	Kg
4885.00N	Use T° : from -25° to + 250 °C	7	6	1,8	1	0,54

This thermometer has a 1 meter (3 feet)- metal wire. The probe resists to temperatures from 0°C to 250°C. It is used to read the inner temperature of food during cooking. Instant digital readout. The stainless steel probe and wire are heat resistant. Equipped with an automatic alarm sound. There is a magnet for metal surface attachment.

Digital waterproof thermometer for meat -50°C to +200 °C



Thermometer for foie gras and ham- from + 30°C to +100°C



Code	Designation	Lcm	Kg
4881.00N	L. probe 12 cm	20	0,06

Code	Designation	Wcm	Liters.	Kg
4882.01	in a protective plastic holder	0,6	24	0,02

This electronic digital thermometer is helpful for checking the temperature of cooking meat. The probe is pointed and penetrates easily into the meat. Do not use in the oven or in microwave oven.

Electronic thermocouple thermometer K IP65 for vacuum cooking

Code	Designation	Øcm	Lcm	Wcm	Th.mm	Kg
4885.20	Case thermocouple thermometer K IP65 Precision +/-1% or +/- 1°C from -64°C to +1400°C	8	4,2	2,2	0,05	
4885.21	Thermocouple probe K - from - 40° to +110°C - probe 60 mm (1)	0,12	100,8			0,02
4885.22	Thermocouple probe K - from - 40° to +110°C - probe 120 mm (2)	0,12				
4885.24	Thermocouple probe K - from - 50° to +300°C - probe 100 mm (3)	3,2	117,5		1,8	0,13
4885.25	Thermocouple probe K - from - 50° to +250°C - probe 60 mm (4)	1	100,8		2,2	0,03
4885.23	Adhesive foam for vaccum cooking	500	1	5	0,02	

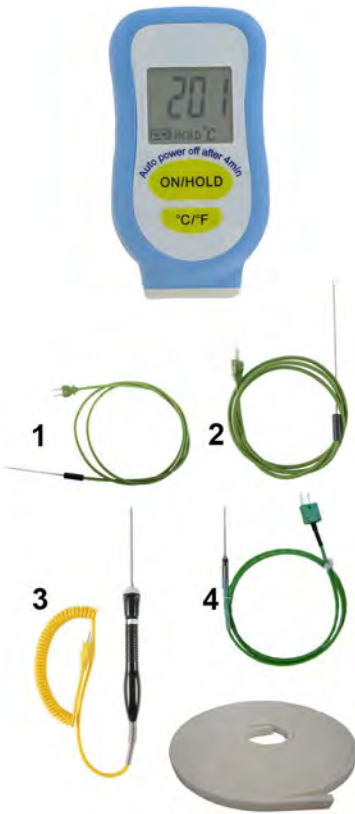

- The thermocouple casing is suitable for any kind of thermocouple probe cable type K. Waterproof, simple and robust.
- The penetration probes 4885.21/22 are suitable for vacuum cooking. The probe can be used in the oven but the temperature must be kept around 100°C max.
- The penetration probe 4885.24 is suitable for classic cooking . The probe can not be used in the oven.
- The penetration probe 4885.25 is used for baking heart and under vaccum cooking. Cable 1 meter. This probe can be used in the oven.
- The adhesive PE foam 4885.23 enables to preserve the tightness when temperature is measured with the probe. Just cut a piece of foam and stick it on the vacuum plastic bag before pricking with the penetration probe.

Kit THERMO CONNECT PRO with sensor

Code	Designation	Lcm	Wcm	Th.mm	Kg
4885.30	Kit THERMO CONNECT PRO : Case and sensor	16,5	15	5	0,15
4885.31	Sensor Thermo Connect Pro	13,5	8,3	6,1	0,05



Thermometer and hygrometer ambient + probe temperature (cable 1.5 meter) with transmission via radio frequency (868 mhz) and internet.
Warning, monitoring and temperature recording on mobile.
Graphic, transmission via email (csv file).
Kit 4885.30 necessary. Do not buy a sensor alone.
MEASURING INTERVAL : 3,5 min (except high variation and alert)
Range : -40+60°C /20-99%
Accuracy : +/-1°C / +/-5% - Sonde +/- 0,5°C
Sensor : 2x1,5V AAA not included (1 year)

Infrared thermometer from -38°C to +365°C.

Code	Designation	Lcm	Wcm	Kg
4881.10		18,5	8	0,17



AUTO-OFF function . Backlight. Indicates temperature in °C or °F
Supplied with a cover for belt.
2 batteries 1.5V included.

Mini electronic hygrometer thermometer



Code	Designation	Lcm	Wcm	Th.mm	Kg
4885.02		4,6	4,4	1,6	0,02

Indicates the temperature and the humidity rate for inside temperature.
 Magnet on the back.
 Accuracy : +/- 1° C / +/-5%. Range : -30+60°C / 0 - 95%
 1 battery LR1130 included

Stainless steel mechanical timer with magnet



Code	Designation	Øcm	Th.mm	Kg
4650.10		6	3,8	0,09

Countdown the remaining time in red.
 Ringtone strong. It has a magnetic back.

Electronic stopwatch timer - 20 hours



Code	Designation	Lcm	Wcm
4650.00N	Timer 20 hours Stopwatch 20 minutes	50	60

This timer is a count down one (up to 19hours and 59 minutes) and is ideal for cooking in order to respect cooking time. It has a magnetic back clip and easel stand. Battery included.

UTENSILS

Polyethylene cutting board



Code	Designation	Lcm	Wcm	Hcm	Kg
	Sharp angles				
4920.60N	White	60	40	2	3,9
4920.60B	Blue	60	40	2	3,9
4920.60R	Red	60	40	2	3,9
4920.60V	Green	60	40	2	3,9
4920.60J	Yellow	60	40	2	3,9

The polythene cutting board is more hygienic than a wooden board because of the non-porous material.

Stainless steel cutting board rack for 6 boards



Code	Designation	Lcm	Wcm	Hcm	Kg
4140.00N	Spacement 3 cm	27	31,5	27,5	1,1

This practical rack lets you stack different cutting boards away or leave them to drain after washing. It lets you easily identify and take the right board.

Metal cleaner



Code	Designation	Øcm	Hcm	Liters.	Kg	PU
	COPPER cleaner					
4200.01N	150 ml	7,5	6	0,15	0,24	6
4200.11N	1000 ml	13	14	1	1,29	1
	SILVER cleaner					
4200.02N	150 ml	7,5	6	0,15	0,17	6
4200.12N	1000 ml	13	14	1	1,13	1
	STAINLESS STEEL CLEANER					
4200.03N	150 ml	7,5	6	0,15	0,13	6

This cleaner gives brilliance back to your utensils. It is really easy to use: First, clean your pan. Wet the sponge with hot water and dip it in the cleaner. Rub the whole pan with the sponge. Then rinse it with hot water and dry it carefully.

Alcohol gel for burning.



Code	Designation	Øcm	Lcm	Wcm	Hcm	Liters.	Kg	PU
4409.01N	Set of 2 small measures 80 gr.	9			2		0,2	6
4409.02N	Gel alcohol small measure 200 g	8,5			5		0,25	1
4409.52N	Box of 72 measures 200 gr.							1
4409.05N	Gel alcohol 1- liter bottle				23,5	1	1	12
4409.04	Gel alcohol bucket 4 kg	26	18,5				4	4

Safer than liquid methylated spirit, this alcohol gel for burning is odourless and has the same heating power as liquid methylated. This high-heat output alcohol will maintain heat for 3,5 hours per 200g shot. Meets environmental standards. ETHANOL spirit.

UTENSILS

Foodgrade string Rotifil - Heavy duty



Code	Designation	Øcm	Hcm	Kg
4337.01	Set of 10 reels 45 gr Rotifil 2TE ø 0,8mm	6	4,8	0,45
4338.01	Reel 1 kg Rotifil 3TE ø 01,1 mm	10	14	1

High resistance to breaking. Use from -40°C to +220°C. Regular diameter - height - weight. Good whiteness Foodgrade. Suitable for direct contact with foodstuffs in compliance with legislation in force EU 10/2011. Guaranteed without formaldehyde. Slightly absorbent. Can be used in automatic machine. Made in France.

Box of 10 neoprene pairs of handle gloves for thermic protection



Code	Designation	Lcm	Wcm	Hcm	Kg
4636.10	Small size 7 cm	24	14,5	6	0,36
4636.20	Large size 11 cm	24	14,5	6	0,44

Fits to the handles of stewpan, sauté-pan etc. to handle without any risk of burning

Box of 10 neoprene handle gloves for thermic protection



Code	Designation	Lcm	Wcm	Hcm	Kg
4636.00		20,5	13	5,5	0,26



Made in France
BYER
X-ACT
EST. 1833

PÂTISSERIE: AN ART AND A SCIENCE

When it comes to pâtisserie, you can let your imagination run wild and try out anything that takes your fancy. Our equipment has been developed to guarantee precise results and beautiful aesthetics. We work with leading pastry chefs including winners of the World Pastry Cup and the Meilleur Ouvrier de France competition who help us develop new and innovative utensils that are highly technical and brilliantly performing.

- 166 -
Baking supports
& trays

- 175 -
Steel moulds
Nonstick steel moulds

- 180 -
Stainless steel forms and rings

- 197 -
Cutters & rolls

- 201 -
Professional combs and frames
Chocolate work, sugar work

- 207 -
Nozzles & pastry bags

- 223 -
Pastry accessories





For the use in domestic oven of the baking trays, baking supports and mats
choose the size 40 x 30 cm max.
 The GN and 60 x 40 cm sizes are suitable for professional ovens.

Steel baking tray straight edges

Code	Designation	Lcm	Wcm	Hcm	Th.mm	Kg
5362.40		40	30	2	1,2	1,57
5320.53	GN 1/1	53	32,5	2	1,2	1,97
5362.60		60	40	2	1,2	2,58



This black steel plate tray gives perfect heat transmission. This kind of steel plate is perfect for baking: it will not stain the bottoms of cakes or croissants. The surface of this steel plate is micro-roughened, creating an air mattress between the food to be cooked and the metal. Very resistant to long-lasting temperature changes.

Steel baking tray oblique edges

Code	Designation	Lcm	Wcm	Hcm	Th.mm	Kg	PU
5321.53	GN 1/1	53	32,5	1	1,2	1,71	5
5321.65	GN 2/1	65	53	1	1,2	3,28	3
5363.40		40	30	1	1,2	1,12	5
5363.60		60	40	1	1,2	2,24	5

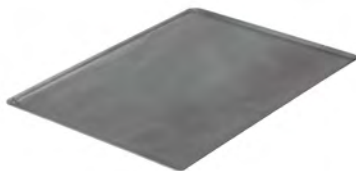

This black steel plate tray gives perfect heat transmission. This kind of steel plate is perfect for baking: it will not stain the bottoms of cakes or croissants. The surface of this steel plate is micro-roughened, creating an air mattress between the food to be cooked and the metal. Very resistant to long-lasting temperature changes.

Aluminium baking tray - Special hard 1,5mm-thick aluminium

Code	Designation	Lcm	Wcm	Hcm	Th.mm	Kg
7362.60	Straight edges	60	40	2	1,5	1,14



This aluminium tray is specially designed for transmitting the cold in frozen food cabinets.

Aluminium baking tray - Special hard 1,5mm-thick aluminium



Code	Designation	Lcm	Wcm	Hcm	Th.mm	Kg	PU
7360.40	Oblique edges	40	30	1	1,5	0,5	5
7360.53	Oblique edges	53	32,5	1	1,5	0,8	5
7360.60	Oblique edges	60	40	1	1,5	0,95	5

Perforated flat baking tray - hard 1,5 mm thick aluminium



Code	Designation	Lcm	Wcm	Th.mm
7368.30	special for mini domestic oven	30	20	1,5
7368.40		40	30	1,5
7368.53		53	32,5	1,5
7368.60		60	40	1,5

No edge for optimized space : it enables to put a baking paper or a mat completely flat. The perforations ø 3 mm enable an homogeneous cooking.

Perforated baking tray - Special hard 1,5mm-thick aluminium



Code	Designation	Lcm	Wcm	Hcm	Th.mm	Kg	PU
7367.40	Perforated ø 3 mm, oblique edges	40	30	1	1,5	0,5	5
7367.53	Perforated ø 3 mm, oblique edges	53	32,5	1	1,5	0,6	5
7367.60	Perforated ø 3 mm, oblique edges	60	40	1	1,5	0,72	5

The perforated plate with formed edges is ideal for use in fan ovens. Example : toasting almonds. It is a perfect support for cooking in silicone pastry moulds.

Non-stick aluminium perforated rectangular pastry tray - Holes ø 3 mm



Code	Designation	Lcm	Wcm	Th.mm
8162.40		40	30	2
8162.53		53	32,5	2
8162.60		60	40	2

This non-stick tray with its slightly raised edges is perfect for making pizzas, flammenkuche, etc. The bottom is perforated to enable you to obtain a crusty-baked pie bottom. Easy to clean.

Rect. non-stick baking tray aluminium, oblique edges, thickness 1,5 mm

Code	Designation	Lcm	Wcm	Hcm	Th.mm	Kg	PU
8161.40	Rectangular pastry tray	40	30	1	2	0,65	5
8161.60	Rectangular pastry tray	60	40	1	2	1,3	5
8161.35	GN 2/3	35	32		2	0,62	5
8161.65	GN 2/1	65	53	1	2	1,9	5
8161.53	GN 1/1	53	32,5	1	2	0,95	5



These aluminium non-stick baking trays are designed for oven-cooking and are coated with "Choc" PTFE, ensuring optimum non-stick qualities. The edges are flared, thus preventing preparations from running off the plate during cooking.

St. steel baking tray, straight edges, Th. 1mm

Code	Designation	Lcm	Wcm	Hcm	Th.mm	Kg
3320.53	GN 1/1	53	32,5	1,5	1	1,55
3360.40		40	30	1,5	1	1,12
3360.60		60	40	1,7	1	2,13

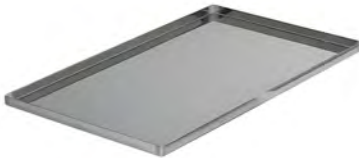

Made of stainless steel, this straight-edged tray is perfectly hygienic and easy to keep clean.

St. steel baking tray, oblique edges, Th. 1mm

Code	Designation	Lcm	Wcm	Hcm	Th.mm	Kg	PU
3321.53	GN 1/1	53	32,5	1	1	1,34	5
3321.65	GN 2/1	65	53	1	1	2,72	5
3361.40		40	30	1	1	0,9	5
3361.60		60	40	1	1	1,84	5



Made from stainless steel, this tray is perfectly hygienic and easy to keep clean.

Stainless steel fluted sheet for "Tuiles"

Code	Designation	Hcm	Th.mm	Kg
3366.35	35 x 32 cm	2	0,6	1,02



These flat stainless steel trays are rugged, easy to use, and easy to keep clean.



Baking wire grate, st. steel

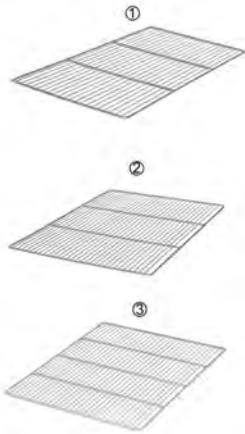

Code	Designation	Lcm	Wcm	Th.mm	Kg	PU
3330.53N	GN 1/1 - 2 crosspieces (1)	53	32,5	2	0,57	5
3330.60N	St. steel grate 60x40 cm 2 crosspieces (2)	60	40	2	0,79	5
3330.65N	GN 2/1 - 3 crosspieces (3)	65	53	3	1,7	5

This professional stainless steel cake grate is easy to keep clean. The crossbars and frame are 5mm (3/16") diameter and the grid wire 2mm (1/16"). It is very robust and will not distort.

Professional grade baking grate made from nickel plated wire

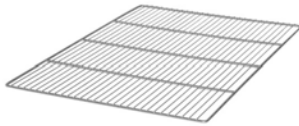

Code	Designation	Lcm	Wcm	Hcm	Th.mm	Kg	PU
0236.60N		60	40	0,7	2	0,67	5

This professional grade nickel plated baking grate is excellent value for money.

Scraper brush for oven, wooden handle



Code	Designation	Lcm	Wcm	Hcm	Kg
4875.70		71	11,5	5	0,28

The scraper brush is used for brushing the hearth and pushing back the embers in your wood-fired oven.

Silicone-coated baking paper - 100 % natural- Professional sizes



Code	Designation	Lcm	Wcm	Hcm	Kg
4359.00	Box of 250 sheets 60 x 40 cm	60	40	2	2,74
4358.00	Box of 250 sheets GN 1/1	53	32,5	2	1,92

Baking paper unbleached - Brown - Non-stick Silicone coated - double side - Reusable Natural & Ecological. For oven cooking (traditional and microwave) of pastry, breads and special frozen products until 220°C (428°F). 100% natural fibre 100% PEFC * & PFOA free guaranteed

Roll of silicone-coated baking paper - Unbleached 100 % natural



Code	Designation	Kg
4357.00	l. 38 cm x 8 m Delivered in decorated box	0,13

Baking paper unbleached - Brown
 - Non-stick Silicone coated - double side
 - Reusable Natural & Ecological.

For oven cooking (traditional and microwave) of pastry, breads and special frozen products until 220°C (428°F). 100% natural fibre 100% PEFC * & PFOA free guaranteed

Baking non-stick sheet - Professional size 60 x 40 cm



Code	Designation	Lcm	Wcm	Kg	PU
	from - 170°C to + 260 °C				
4344.08N	0,08 mm thick	60	40	0,03	10
4344.13N	0,13 mm thick	60	40	0,05	10

This baking sheet is made from PTFE-coated glass fiber for perfect non-stick properties. It has the advantage of being reusable 200 times over. It proves to be very economical and can be used for lots of different applications.

Baking non-stick sheet



Code	Designation	Øcm	Lcm	Wcm	Kg
	from - 170°C to + 260 °C				
4344.01	40 x 30 cm		40	30	0,01
4344.02	Round ø 26 cm Delivered in decorated box	26			0,01

This baking sheet is made from PTFE-coated glass fiber for perfect non-stick properties. It has the advantage of being reusable 200 times over. It proves to be very economical and can be used for lots of different applications.

Baking non-stick silicone mat



Code	Designation	Lcm	Wcm	Kg
4931.40N		40	30	0,1
4931.58N	60 x 40 cm	58,5	38,5	0,21
4931.51N	GN 1/1	51,5	31	0,14

This cooking mat is made from canvas dipped in food-grade silicone to prevent any sticking whatsoever. It replaces greaseproof paper and can stand an average 1000 visits to the oven.
 Maximum temperature: 280°C (536°F).

This mat can also be used as an underlying support for freezing and deep-freezing.
 It is easily cleaned with hot water and a sponge.





Silicone coated fiberglass baking mesh "AIRMAT"



Code	Designation	Lcm	Wcm	Kg
4938.40		40	30	0,06
4938.58		58	38	0,11
4938.51		51	31	0,09

Perfect for baking choux paste and bread & tart doughs. Ideal to bake rawfrozen doughs. Can be used as a freezing support. Use T°: -55°C à +280°C (-67°F to +536°F). Ventilated fabric for an homogeneous cooking and crispy dough bottoms. Silicone-coated nonstick fiberglass fabric: do not grease. The baking mat is to combine with a perforated aluminium oven tray.

Non-stick silicone pastry mat with marks for Macarons cooking

Code	Designation	Lcm	Wcm	Th.mm	Kg
	Circles ø 15 and 35 mm				
	-40°C / + 230°C (-40°F / +446°F)				
4935.40	44 round marks	40	30	0,8	0,16
4935.60	88 round marks	60	40	0,8	0,21



Drawings ø 35 mm are really useful for covering the tray keeping lines for filling with a pastry bag for Macarons. The small circles ø 15 mm help to place the pastry bag in the centre and realize perfect macaroons. This product will be useful for mass production in order to obtain always the same finishing touches. Non-stick, suitable for oven cooking. To combine with the flat tray 7368.

Non-stick silicone pastry mat with marks

Code	Designation	Lcm	Wcm	Kg
	Non-stick recto / non-skid verso			
	Marks for tarts			
	ø 12 - 16 - 20 - 24 - 28 - 32 cm			
	Graduated in cm and inches			
4937.60		60	40	0,36



This silicone pastry mat allows pie pastry to be rolled on a worktop without the need to dust it with flour. The marks indicate the upright quantity of pastry to the exact size of the tart mould. Graduated on the sides. This mat can also be used in the oven as a baking mat or as an underlying support for freezing and deep-freezing (-60°C/+260°C). Easy cleaning.

Round-edge pastry tray golden aluminium

Code	Designation	Lcm	Wcm	Th.mm	Kg	PU
8967.24		24	19	0,8	0,1	5
8967.31		31	24	0,8	0,17	5



This tray is in anodized gold-look aluminium; the corners are rounded. It ensures an elegant appearance.

Round-edge tray st. steel

Code	Designation	Lcm	Wcm	Th.mm	Kg	PU
3201.24		24	19	0,8	0,31	5
3201.31		31	24	0,8	0,5	5



This stainless steel tea tray has a polished finish and guarantees your preparations a particularly elegant appearance. It is easy to keep clean. The corners are rounded.



Mould for upside down pie "Tatin", non-stick aluminium CHOC Ceramic



Code	Designation	Øcm	Hcm	Th.mm	Kg
	" Tatin Tart " recipe included				
8237.20	2/4 portions	20	4,2	4,7	0,57
8237.24	4/6 portions	24	4,6	4,7	0,82
8237.28	6/8 portions	28	4,8	4,7	1,07
8237.32	8/10 portions	32	5,1	4,7	1,31

This mould, with extra-thick walls to spread heat evenly, proves ideal for upside-down apple tarts, since it allows you to form a caramel layer directly in the mould while it's on the heat sources. Once the caramel is

formed in the mould, just add the apple slices, cover with pastry, and place the mould in the oven. Preparation and cooking in one single mould. All heat sources except induction.

Mould for upside down pie "Tatin", non-stick cast aluminium CHOC EXTREME Induction

Code	Designation	Øcm	Hcm	Th.mm	Bottom ø cm	Kg
8320.24	4/6 p.	24	5	3	16	0,82
8320.28	6/8 p.	28	5,5	3	18,5	1,2



This mould proves ideal for Tatin tarts, since it allows you to form a caramel layer directly in the mould while it's on the heat. Once the caramel is formed in the mould, just add the apple slices, cover with pastry, and place the mould in the oven. Pressure cast aluminium is ideal for providing regular cooking conditions and the thick bottom stands up excellently to deformation.

Round stainless steel grate with feet

Code	Designation	Øcm	Hcm	Kg
0237.28		28	1,5	0,15
0237.32		32	1,7	0,23

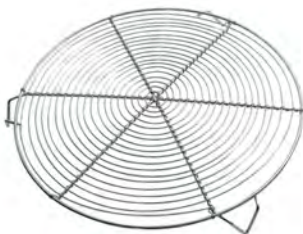

Round pierced pizza tray, aluminium - Hole ø 10 mm



Code	Designation	Øcm	Hcm	Th.mm	Kg	PU
7366.24		24	0,7	1	0,11	5
7366.26		26	0,7	1	0,13	5
7366.28		28	0,7	1	0,15	5
7366.32		32	0,7	1	0,2	5

The low-profile pie tray with its slightly raised edges is perfect for making pizzas, flammenkuche savory tarts, etc. The bottom is perforated to enable you to obtain a crusty-baked pie bottom.

Non-stick aluminium round tray "CHOC"



Code	Designation	Øcm	Hcm	Th.mm	Kg
8136.24	Round pizza tray	24	1	2	0,29
8136.28	Round pizza tray	28	1	2,3	0,41
8136.32	Round pizza tray	32	1	2,3	0,52

This round aluminium PTFE-coated plate is completely non-stick, tough, and easy to keep clean. The edge is slightly raise to prevent the mixture from spilling over into the oven during cooking.

Non-stick aluminium perforated round tray "CHOC"

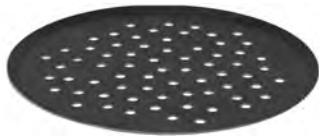

Code	Designation	Øcm	Th.mm	Kg
8137.24		24	2,2	0,26
8137.28		28	2,3	0,36
8137.32		32	2,3	0,47

The non-stick pie tray with its slightly raised edges is perfect for making pizzas, flammenkuche savory tarts, etc. The bottom is perforated to enable you to obtain a crusty-baked pie bottom. Easy to clean.

Round pizza tray, heavy blue steel



Code	Designation	Øcm	Th.mm	Kg	PU
5350.20		20	1	0,26	5
5350.24		24	1	0,37	5
5350.26		26	1	0,43	5
5350.28		28	1	0,52	5
5350.32		32	1	0,65	5
5350.36		36	1,2	1	5
5350.40		40	1,5	1,2	5

This round tray with flared edges is made of blue steel plate, 1.0mm to 1.5mm thick (16-20 gauge) according to diameter. The plaque will not distort and ensures good heat transmission. This

steel plate has a high-quality surface that will not stain pastry bottoms; it is micro-roughened, creating an air mattress between the food to be cooked and the metal. Ideal for pizzas.

Perforated pizza tray, heavy blue steel - Holes ø 10 mm



Code	Designation	Øcm	Th.mm	Kg	PU
5353.24		24	1	0,32	5
5353.28		28	1	0,45	5
5353.32		32	1	0,59	5

Fluted pie pan, heavy blue steel



Code	Designation	Øcm	Hcm	Th.mm	Kg	PU
PIE PAN WITH FIXED BOTTOM						
5356.24N		24	2,5	0,6	0,28	5
5356.27N		26,3	2,5	0,6	0,33	5
5356.30N		29,2	2,5	0,6	0,37	5
5356.32N		31,3	2,5	0,6	0,45	5

The high-sided pie tray is ideal for making all kinds of quiches and tarts. Steel plate is a very good heat conductor and lets you make crusty pie pastries.

Fluted pie pan with loose base, heavy blue steel



Code	Designation	Øcm	Hcm	Th.mm	Kg	PU
5357.24		24	2,5	0,6	0,34	5
5357.27		26,3	2,5	0,6	0,39	5
5357.30		29,2	2,5	0,6	0,44	5
5357.32		31,3	2,5	1	0,48	5

The high-sided pie tray is ideal for making all kinds of quiches and tarts. Steel plate is a very good heat conductor and lets you make crusty pie pastries. The model with loose

base is easy to use as it allows problem-free removal.

Round fluted tartlet mould, heavy blue steel



Code	Designation	Øcm	Hcm	Th.mm	Kg
5356.09		9	2	0,6	0,05
5356.11		11	2	0,6	0,07
5356.14		14	2	0,6	0,1
5356.17		17	3	0,6	0,16



Rectangular cake mould , heavy blue steel



Code	Designation	Lcm	Wcm	Hcm	Th.mm	Kg
5359.26		9	26	11	0,6	0,37

Baking fluted mould for "Tuile" and bread made of blue steel



Code	Designation	Lcm	Wcm	Th.mm	Kg
5358.35		35	14	0,6	0,31



Suitable also for giving a rounded shape for chocolate

decors or almond tuiles.



Round fluted tart mould with straight edge



Round fluted tart mould with straight edge - Loose base



Code	Designation	Øcm	Hcm	Th.mm	Kg
4705.20		20	2	0,6	0,18
4705.24		24	2,8	0,6	0,32
4705.28		28	3	0,6	0,43
4705.32		32	3	0,6	0,56

Code	Designation	Øcm	Hcm	Th.mm	Kg
4706.20		19,8	2	0,6	0,21
4706.24		23	2,8	0,6	0,32
4706.28		28	3	0,6	0,47
4706.32		32	3	0,6	0,61

Round fluted fruit tart mould



Code	Designation	Øcm	Hcm	Th.mm	Kg
4707.28		28	3	0,4	0,26

Rectangular fluted tart mould with loose base



Code	Designation	Lcm	Wcm	Hcm	Th.mm	Kg
4708.20		20	8	2,7	0,6	0,15
4708.36		35,6	10,2	2,7	0,6	0,32

Square fluted tart mould with loose base



Code	Designation	Lcm	Wcm	Hcm	Th.mm	Kg
4709.18		18	18	2,7	0,6	0,25
4709.23		23	23	2,7	0,6	0,41

Charlotte round mould without lid



Code	Designation	Øcm	Hcm	Kg
4719.18		18	10	0,23
GLASS LID FOR CHARLOTTE MOULD :				
3429.18		18		0,35

Square pastry mould



Code	Designation	Lcm	Wcm	Hcm
4700.22		22,5	22,5	5



Round pastry mould

new
2019



Code	Designation	Øcm	Hcm	Kg
4718.16		16	5	0,14
4718.20		20	5	0,2
4718.26		26	5	0,3

Round pastry mould



Code	Designation	Øcm	Hcm	Th.mm	Kg
4717.20		20	3,7	0,6	0,17
4717.23		23	3,8	0,6	0,21
4717.28		28	5	0,6	0,32

Brioche fluted mould



Code	Designation	Øcm	Hcm	Th.mm	Kg
4702.10	Mini brioche mould	10	4,5	0,4	0,05
4702.22		22	8,3	0,4	0,24

Kougloff mould



Code	Designation	Øcm	Hcm	Kg
4701.22		22	10	0,29



Round fluted tart mould with oblique edge



Code	Designation	Øcm	Hcm	Th.mm	Kg
4703.10		10	2	0,4	0,04
4703.12		12	2	0,4	0,05

Set of 4 "Canelés Bordelais" fluted individual moulds



Code	Designation	Hcm	Kg
4718.05		5,5	0,16

Rectangular tray of individual pastry moulds



Code	Designation	Lcm	Wcm	Hcm	Th.mm	Kg
4843.00	12 Muffins ø 7 cm Ht 3 cm	38	27	3,5	0,4	0,42
4710.12	12 Madeleines	26	20	1,4	0,4	0,2
4711.12	12 round tarlets ø 7 cm	34	26	1,9	0,4	0,35
4712.06	6 Mini-Savarins ø 8 cm	21,5	31,5	2,2	0,4	0,34
4712.12	12 Mini-Savarins ø 7 cm	34,3	26,2	2,2	0,4	0,4

Round Savarin pastry mould



Code	Designation	Øcm	Kg
4712.24		24	0,41



Dismontable round Savarin pastry mould - 2 bottoms for 2 uses



Code	Designation	Øcm	Kg
4766.26		26	0,55

Dismontable round pastry mould



Code	Designation	Øcm	Hcm	Kg	PU
4844.20		20	6,7	0,27	3
4844.24		24	6,7	0,3	3
4844.26		26	6,7	0,33	3
4844.28		28	6,7	0,36	3

Rectangular cake mould with rounded edges



Code	Designation	Lcm	Wcm	Hcm	Th.mm	Kg
4715.15		15	7,5	4,8	0,4	0,1
4715.24		24	13	6,1	0,4	0,23
4715.26		26	10	6,3	0,4	0,21

Rectangular cake mould with folded edges

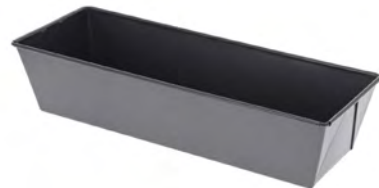

Code	Designation	Lcm	Wcm	Hcm	Th.mm	Kg
4716.25		25	10,8	7	0,3	0,24
4716.30		30	10,8	7	0,3	0,28

Perforated baking tray for 2 baguettes



Code	Designation	Lcm	Wcm	Hcm	Th.mm	Kg
4713.02		37	16,2	2,5	0,6	0,26

Oven tray with insulating double wall



Code	Designation	Lcm	Wcm	Hcm	Th.mm	Kg
4714.00		35,5	27,5	0,3	0,4	0,68

Suitable also for giving a rounded shape for chocolate decors or almond tuiles.

Double wall : perfect for macaroons and cookies cooking.



l'école
VALRHONA
東京



Perforated stainless steel tart ring with straight edge - ROUND

l'école
VALRHONA
東京



Code	Designation	Øcm	Hcm	Kg
HEIGHT 2 CM				
3099.01	4,7 cl	5,5	2	0,02
3099.02	6,6 cl	6,5	2	0,02
3099.03	8,8 cl	7,5	2	0,03
3099.00	11,3 cl	8,5	2	0,03
3099.04	17,3 cl	10,5	2	0,04
3099.05	24,5 cl	12,5	2	0,04
3099.06	37,7 cl	15,5	2	0,05
3099.07	53,7 cl	18,5	2	0,07
3099.08	66 cl	20,5	2	0,08
3099.09	94,2 cl	24,5	2	0,1
3099.10	127,6 cl	28,5	2	0,12
HEIGHT 3,5 CM				
3098.01		2019	5,5	3,5
3098.02		2019	6,5	3,5
3098.03		2019	7,5	3,5
3098.00		2019	8,5	3,5
3098.04		2019	10,5	3,5
3098.05		2019	12,5	3,5
3098.06		2019	15,5	3,5
3098.07		2019	18,5	3,5
3098.08		2019	20,5	3,5
3098.09		2019	24,5	3,5
3098.10		2019	28,5	3,5
3006.01	Pusher for round ring ø 7.5 - 8 cm	7,4	6,1	0,05

Created in partnership with the "Ecole Valrhona", these new tart rings with small holes enable an uniform baking of the pie/tart edges. The straight edge allows an easy removal and a perfect pastry rim.

Perforated stainless steel tart ring with straight edge - HEXAGONAL

new
2019



Code	Designation	Lcm	Wcm	Hcm	Kg
In partnership with the "Ecole Valrhona"					
3099.60		11	11	2	0,04
3099.61		22	22	2	0,1
3099.62		26,5	26,5	2	0,12
3099.63		31	31	2	0,14

Created in partnership with the "Ecole Valrhona", these new tart rings with small holes enable an uniform baking of the pie/tart edges. The right edge allows an easy removal and a perfect pastry rim.



Perforated stainless steel tart ring with straight edge - HEART



Code	Designation	Øcm	Hcm	Kg
3099.50	9,5 cl - individual	8	2	0,03
3099.51	20 cl - 2 p.	12	2	0,05
3099.52	40 cl - 4 p.	18	2	0,08
3099.53	60 cl - 6 p.	22	2	0,1

Perforated stainless steel tart ring with straight edge - RECTANGLE



Code	Designation	Lcm	Wcm	Hcm	Kg
HEIGHT 2 CM					
3099.30	10 cl - individual	12	4	2	0,09
3099.32	40 cl - 4 p.	25	8	2	0,1
3099.33	60 cl - 6 p.	28	11	2	0,12
HEIGHT 3,5 CM					
3098.30		2019	12	4	3,5
3098.32		2019	25	8	3,5
3098.33		2019	28	11	3,5
3006.03	Pusher for rectangular tartlet ring (except 3943.05)	7,7	2,4	6	0,02

Created in partnership with the "Ecole Valrhona", these new tart rings with small holes enable an uniform baking of the pie/tart edges. The right edge allows an easy removal and a perfect pastry rim.

Perforated stainless steel tart ring with straight edge - SQUARE



Code	Designation	Lcm	Wcm	Hcm	Kg
HEIGHT 2 CM					
3099.19	Perforated indiv. 10 cl	7	7	2	0,04
3099.20	Perforated indiv. 20 cl	8	8	2	0,05
3099.21	40 cl	15	15	2	0,12
3099.23	60 cl	17,5	17,5	2	0,13
3099.22	80 cl	20	20	2	0,15
HEIGHT 3,5 CM					
3098.19		2019	7	7	3,5
3098.20		2019	8	8	3,5
3098.21		2019	15	15	3,5
3098.22		2019	20	20	3,5
3098.23		2019	17,5	17,5	3,5
3006.02	Pusher for square pastry form 8 cm	7,7		6,1	0,04
3318.02	Cutter for square tartlet 8 cm Ht 2 cm	14	12	4,1	0,13

Created in partnership with the "Ecole Valrhona", these new tart rings with small holes enable an uniform baking of the pie/tart edges. The right edge allows an easy removal and a perfect pastry rim.

Perforated stainless steel tart ring with straight edge- CALISSON



Code	Designation	Lcm	Wcm	Hcm	Kg
3099.70	10 cl - Individual ring	12	5	2	
3318.05	St/steel cutter for individual form Calisson				
3006.05	St/steel pusher for individual form Calisson	10,5	4	6,1	0,03
3099.72	20 cl - 2 p.	18	7,8	2	
3099.73	40 cl - 4 p.	25,5	11	2	

Perforated stainless steel tart ring with straight edge - OBLONG



Code	Designation	Lcm	Wcm	Hcm	Kg
3099.40	9,3 cl - individual	14,5	3,5	2	0,06
3006.04	Pusher for oblong rings L. 14 cm	14	3,2	6,1	0,03
3099.42	40 cl - 4 p.	27	8	2	0,09
3099.43	60 cl- 6 p.	30	11	2	0,1

Perforated fluted stainless steel tart ring with straight edge

new
2019

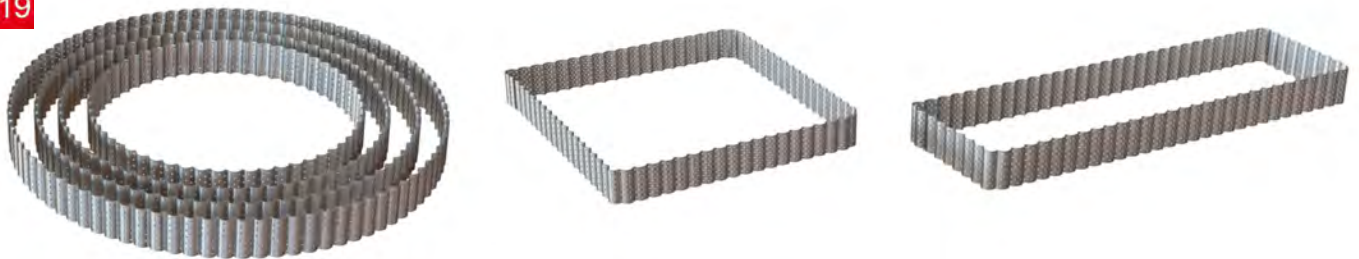

Code	Designation	Øcm	Lcm	Wcm	Hcm
	ROUND				
3030.20		20			3
3030.24		24			3
3030.28		28			3
3030.32		32			3
	SQUARE				
3031.23			23	23	3
	RECTANGULAR				
3032.35			35	10	3

Christophe Renou

MOF 2015 Master pastry chef at the famous pastry school L'Ecole Valrhona.

For the MOF competition, C. Renou decided to work on the theme of "Sweet Picasso", especially on the painter's cubist influences.

Discover the original pastry forms he created and we propose you now



Stainless steel tart rings - CREATION C. RENO

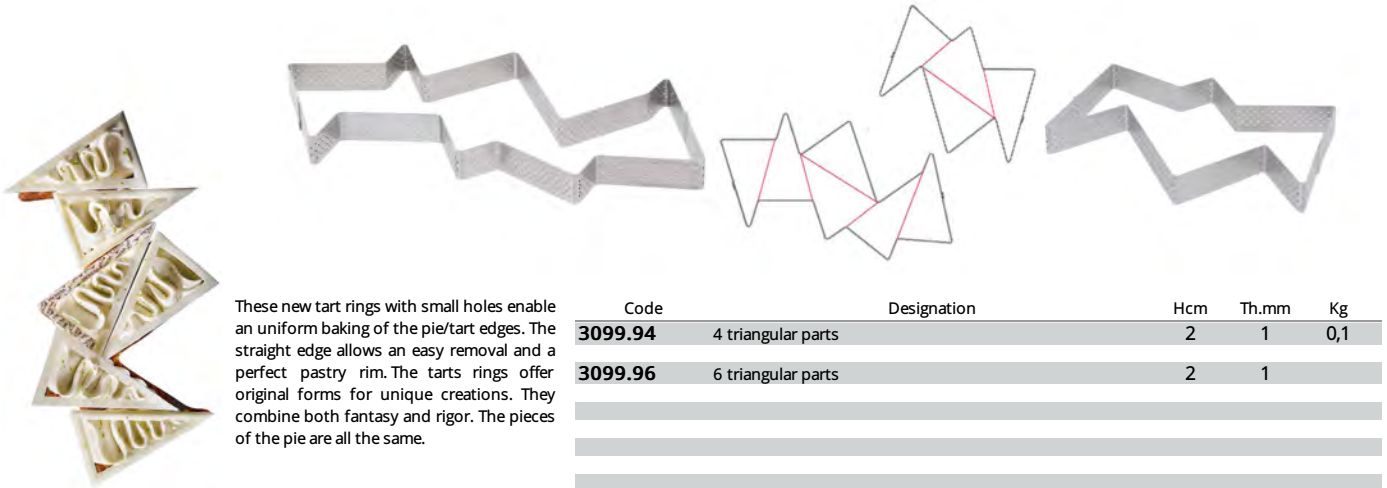

These new tart rings with small holes enable an uniform baking of the pie/tart edges. The straight edge allows an easy removal and a perfect pastry rim. The tarts rings offer original forms for unique creations. They combine both fantasy and rigor. The pieces of the pie are all the same.

Code	Designation	Hcm	Th.mm	Kg
3099.94	4 triangular parts	2	1	0,1
3099.96	6 triangular parts	2	1	

Stainless steel tart rings "EXPERT" - CREATION C. RENO

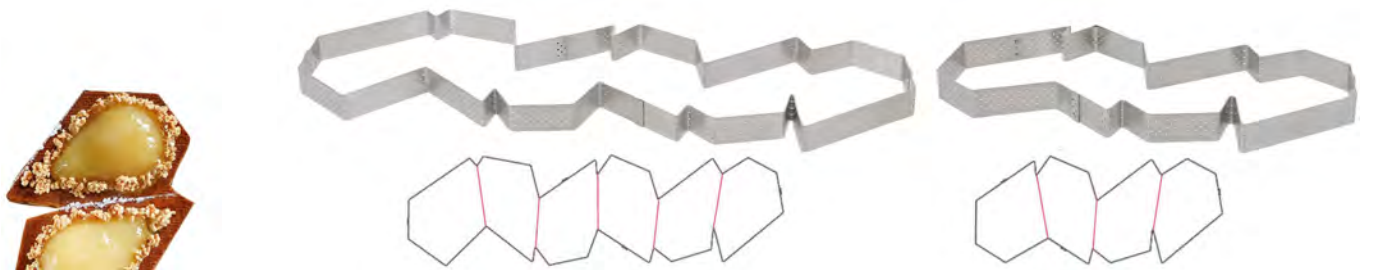

Created in partnership with Christophe Renou, these new tart rings with small holes enable an uniform baking of the pie/tart edges. The straight edge allows an easy removal and a perfect pastry rim. The tarts rings offer original forms for unique creations. They combine both fantasy and rigor.

Code	Designation	Hcm	Th.mm	Kg
3099.84	4 p.	2	1	0,12
3099.86	6 p.	2	1	

Stainless steel pastry form for cream cakes - CREATION C. RENO



Code	Designation	Hcm	Th.mm	Kg
3939.34	4 p.	4	1	0,26
3939.36	6 p.	4	1	

Created in partnership with Christophe Renou, Master Pastry Chef at the "Ecole Valrhona", these new pastry forms offer an original shape for unique creations. They combine both fantasy and rigor. The triangular pieces of the cake are all the same.

Perforated tart ring, rolled edge, height 2 cm



Code	Designation	Øcm	Hcm	Th.mm	Kg
3093.06		6	2	0,4	0,02
3093.08		8	2	0,4	0,03
3006.01	Pusher for round ring ø 7.5 - 8 cm	7,4	6,1		0,05
3093.10		10	2	0,4	0,04
3093.22		22	2	0,4	0,1
3093.24		24	2	0,4	0,11
3093.26		26	2	0,4	0,12
3093.28		28	2	0,4	0,13

These perforated rings are mainly designed for making pies and tarts. The pie ring is easier to use than a mould because it takes up less space on a baking plate and it's easy to turn out. The small

holes around the ring enables to suppress air bubbles to obtain a perfect crusty-baked tart.

Tart ring, rolled edge, height 2 cm



Code	Designation	Øcm	Hcm	Th.mm	Kg
3091.06N		6	2	0,4	0,02
3091.08N		8	2	0,4	0,03
3006.01	Pusher for round ring ø 7.5 - 8 cm	7,4	6,1		0,05
3091.10N		10	2	0,4	0,04
3091.12N		12	2	0,4	0,04
3091.14N		14	2	0,4	0,05
3091.16N		16	2	0,4	0,06
3091.18N		18	2	0,4	0,07
3091.20N		20	2	0,4	0,08
3091.22N		22	2	0,4	0,09
3091.24N		24	2	0,4	0,1
3091.26N		26	2	0,4	0,11
3091.28N		28	2	0,4	0,12
3091.30N		30	2	0,4	0,13
3091.32N		32	2	0,4	0,14

These stainless steel rings, 2cm high (3/4"), are mainly designed for making pies and tarts. The pie ring is easier to use than a mould because it takes up less space on a baking plate (several rings can

be positioned on the same tray). Apart from that, it's easy to turn out.

Stainless steel square rings, height 2 cm



Code	Designation	Lcm	Wcm	Hcm	Th.mm	Kg
3905.08	Small square Ht 2 cm	8	8	2	1	0,05
3006.02	Pusher for square pastry form 8 cm	7,7		6,1		0,04
3318.02	Cutter for square tartlet 8 cm Ht 2 cm	14	12	4,1		0,13
3905.12		12	12	2	1	0,08
3905.16		16	16	2	1,2	0,19
3905.20		20	20	2	1,2	0,16
3905.24		24	24	2	1,2	0,19
3905.28		28	28	2	1,2	0,21

CUSTOMIZATION Consult us for your made-to-measure rings

Stainless steel square rings, height 4,5 cm



Code	Designation	Lcm	Wcm	Hcm	Th.mm	Kg
3906.08	Small square Ht 4,5 cm	8	8	4,5	0,8	0,1
3006.02	Pusher for square pastry form 8 cm	7,7		6,1		0,04
3906.12		12	12	4,5	1	0,17
3906.16		16	16	4,5	1	0,24
3906.20		20	20	4,5	1	0,29
3906.24		24	24	4,5	1,2	0,42
3906.28		28	28	4,5	1,2	0,49

Stainless steel triangle ring, sharp angles



Code	Designation	Lcm	Hcm	Th.mm	Kg	PU
3937.08	small cake = ring ø7,5 cm	9,4	4,5	0,8	0,08	6
3937.16	#NOM?	20	4,5	1	0,21	1
3937.20	#NOM?	25	4,5	1	0,26	1
3937.24	#NOM?	30	4,5	1	0,32	1

An equilateral triangle with sharp angles for modern and original cake shapes. The ring thickness is adapted to the diameter: the stainless steel ring keeps its shape throughout its use but is not too thick for good heat convection during cooking.

Stainless steel round ring, height 4,5 cm



Code	Designation	Øcm	Hcm	Th.mm	Kg	PU
3989.05		5	4,5	0,8	0,04	6
3989.06		6	4,5	0,8	0,05	6
3989.65		6,5	4,5	0,8	0,06	1
3989.07		7	4,5	0,8	0,06	6
3989.75		7,5	4,5	0,8	0,07	6
3989.08		8	4,5	0,8	0,08	6
3006.01	Pusher for round ring ø 7.5 - 8 cm	7,4	6,1		0,05	1
3989.10		10	4,5	0,8	0,09	1
3989.12		12	4,5	0,8	0,11	1
3989.14		14	4,5	0,8	0,12	1
3989.16		16	4,5	1	0,18	1
3989.18		18	4,5	1	0,2	1
3989.20		20	4,5	1	0,22	1
3989.22		22	4,5	1	0,24	1
3989.24		24	4,5	1	0,27	1
3989.26		26	4,5	1	0,29	1
3989.28		28	4,5	1,2	0,36	1

The 4,5 cm high (1-3/4") pastry rings are perfect for mousse-based desserts that have a Joconde biscuit bottom.

Stainless steel round standard - height 6 cm



Code	Designation	Øcm	Hcm	Th.mm	Kg
3940.12		12	6	0,8	0,14
3940.14		14	6	0,8	0,16
3940.16		16	6	1	0,23
3940.18		18	6	1	0,26
3940.20		20	6	1	0,29
3940.22		22	6	1	0,32
3940.24		24	6	1	0,35
3940.26		26	6	1	0,39
3940.28		28	6	1,2	0,4
3940.30		30	6	1,2	0,51

The 6cm high (2-1/2") pastry rings are perfect for vacherins, among other things.



St/steel round high ring -for "PAIN SURPRISE", Panettone, Wedding cakes

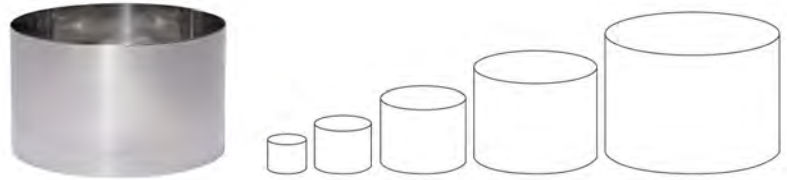

Code	Designation	Øcm	Hcm	Th.mm	Kg
3912.08	30 cl	8	6	1	0,12
3912.12	90 cl	12	8	1	0,23
3912.16	200 cl	16	10	1	0,39
3912.20	380 cl	20	12	1	0,59
3912.24	630 cl	24	14	1	0,82

Perfect for baking Pain Surprise, Panettone or wedding cakes. Suitable for oven cooking and freezing. To combine with baking paper or baking nonstick sheets. Robust and undistortable.

Stainless steel expandable square frame

new 2019

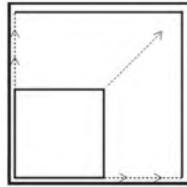

Code	Designation	Lcm	Wcm	Hcm	Th.mm	Kg
3013.16	Max. size 30x30 cm	16	16	5	1	0,57
3013.20	Max. size 37x37 cm Perfect for trays 40x30cm	20	20	5	1	0,69
3013.30	Max. size 5 x57 cm	30	30	5	1	0,82

Setting & maintaining the size thanks to fixing notches. Graduated. Perfect result thanks to the smooth inner side. Waterproof on a flat baking support.

Stainless steel expandable rectangular frame

new 2019

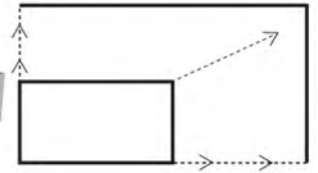

Code	Designation	Lcm	Wcm	Hcm	Th.mm	Kg
3013.21	Exp.to maxi. 40x21cm	21,5	11,5	7,5	1	1,07
3013.43	Exp.to maxi. 56 x84cm	43	29	5	1	1,29

Stainless steel extensible rings - Big sizes

new 2019



Code	Designation	Hcm	Th.mm	Kg
3040.01	from ø 18 to 36 cm - Graduated	4,5	0,8	0,27
3040.02	from ø 18 to 36 cm - Graduated	6,5	0,8	0,37
3040.03	from ø 18 to 36 cm - Graduated Perfect for tarts - 3 cm high	3	0,8	

Oval stainless steel ring



Code	Designation	Lcm	Wcm	Hcm	Th.mm	Kg
3069.21	Equivalent to a ø 16 cm ring	21	14	4,5	1	0,25

The ring thickness is adapted to the diameter : the stainless steel ring keeps its shape throughout its use but is not too thick for good heat convection during cooking.

Stainless steel straight tear-drop ring



Code	Designation	Lcm	Wcm	Hcm	Th.mm	Kg	PU
HEIGHT 40 mm							
3027.20	=14 cm ring	20	12	4	1	0,16	1
3027.23	= 16 cm ring	23	14,5	4	1	0,18	1
3027.26	=18 cm ring	26	16	4	1	0,26	1
3027.08	Individual	8	5	4	0,8	0,05	6

The various pastry ring shapes allow a pastrycook to make cakes that not only taste good but are also good-looking and original, enabling him or her to stand out from the crowd. What's more, the original shape of the cream cake is itself decorative and therefore cuts back on decorating time.

Stainless steel heart-shaped ring



Code	Designation	Øcm	Hcm	Th.mm	Kg	PU
HEIGHT 40 mm						
3077.06	Heart ø 6 cm	6	4	0,8	0,06	6
3077.14	Equivalent to a 14 cm ring	14	4	1	0,16	1
3077.16	Equivalent to a 16 cm ring	16	4	1	0,18	1
3077.18	Equivalent to a 18 cm ring	18	4	1	0,19	1
3077.20	Equivalent to a 20 cm ring	20	4	1	0,22	1
3077.22	Equivalent to a 22 cm ring	22	4	1	0,23	1
3077.24	Equivalent to a 24 cm ring	24	4	1	0,24	1

The heart form lets you make cakes, ice-cream, or other desserts with an original shape that's perfect for birthdays, Mother's Day, and of course, Saint Valentine's day.

Stainless steel pastry form "Calisson"



Code	Designation	Lcm	Wcm	Hcm	Liters.	Th.mm	Kg	PU
3076.22	"Calisson" shaped ring L. 22 cm	22	10	4	0,6	1	0,16	1
3076.27	"Calisson" shaped ring L.27 cm	27	11	4	0,9	1	0,19	1
3076.33	"Calisson" shaped ring L.33 cm	33	14,6	4	1,35	1	0,23	1
INDIVIDUAL :								
3076.11	"Calisson" shaped ring L.11 cm	11	5	4	0,15	0,8		6
3006.05	St/steel pusher for individual form Calisson	10,5	4	6,1			0,03	1
MIGNARDISE:								
3076.05	"Calisson" shaped ring L.5,5 cm	5,5	2,5			0,8	0,02	1



Stainless steel oblong individual ring



Code	Designation	Lcm	Wcm	Hcm	Th.mm	Kg
	CREATION MATHIEU BLANDIN World pastry champion 2013					
3037.14	Oblong Mathieu Blandin In partnership with the "Ecole Valrhona"	14,5	3,5	2	1	0,06
3099.40	Perforated st/steel ring with straight edge 9,3 cl - individual	14,5	3,5	2		0,06
3006.04	Pusher for oblong rings L. 14 cm	14	3,2	6,1		0,03

Stainless steel rectangular ring, sharp corners



Code	Designation	Lcm	Wcm	Hcm	Th.mm	Kg
3943.05		5	2,5	2,5	0,8	0,03
3943.08		8	2,5	2,5	1,2	0,03
3943.10		10	2,5	3	1,2	0,04
3943.12		12	4	3	1,2	0,09
3943.13		12	4	4	1,2	0,12
3942.16		16	3	2,5	1,2	0,09
3941.18		18	3	2	1,2	0,08
3006.03	Pusher for rectangular tartlet ring (except 3943.05)	7,7	2,4	6		0,02

This shape of mould is especially well suited for arranging fillings on a dish: for coating cooked vegetables, rice, vegetarian lasagne, or adding a touch of elegance to dishes such as salmon tartare.

Set FRANCK MICHEL - MOF - : stainless steel rectangular form and cutter

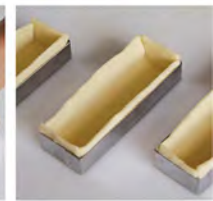

FRANCK MICHEL - MOF and Pastry World Champion - has created this rectangular form and its cutter is to make quickly small original tartlets. The rectangular form has its own cutter, which allows the upright part of the pastry to be cut to the exact size of the form. The narrow tartlets that are easy to hold in the hand.

Code	Designation	Lcm	Wcm	Hcm	Kg
3943.11	Rectangular ring	11,5	4	1,7	0,09
3943.91	Adapted cutter for 3943.11				0,09
3006.03	Pusher for rectangular tartlet ring (except 3943.05)	7,7	2,4	6	0,02

Stainless steel small square individual ring, cutter & pusher



Code	Designation	Lcm	Wcm	Hcm	Th.mm	Kg
3906.08	Small square Ht 4,5 cm	8	8	4,5	0,8	0,1
3905.08	Small square Ht 2 cm	8	8	2	1	0,05
3099.20	Perforated indiv. 20 cl	8	8	2		0,05
3006.02	Pusher for square pastry form 8 cm	7,7		6,1		0,04
3318.02	Cutter for square tartlet 8 cm Ht 2 cm	14	12	4,1		0,13

Stainless steel small individual ring



Code	Designation	Øcm	Lcm	Wcm	Hcm	Th.mm	Kg	PU
3938.40	Round ø 60 - Ht 40 mm	6			4	0,8	0,05	6
3939.06	Round ø 65 - Ht 40 mm	6,5			4	0,8	0,05	6
3096.01	Round ø 45 - Ht 25 mm	4,5			2,5	0,8	0,02	6
3094.01	Round ø 32,5 mm - Ht 20 mm	3,25			2	0,8	0,01	6
3069.06	Ovale equivalent to a ø 60 mm ring		8	5,5	4,5	0,8	0,04	6
3069.07	Ovale equivalent to a ø 70 mm ring		9,5	6,5	4,5	0,8	0,05	6
3094.02	Ovale equivalent to a ø 32,5 mm ring		4	3	2	0,8	0,01	6
3037.06	Oblong equivalent to a ø 60 mm ring		7,4	3,3	4,5	0,8	0,04	6
3037.07	Oblong equivalent to a ø 70 mm ring		8,8	5,2	4,5	0,8	0,05	6
3037.14	Oblong Mathieu Blandin		14,5	3,5	2	1	0,06	1

Stainless steel small individual pastry ring



Code	Designation	Øcm	Lcm	Wcm	Hcm	Th.mm	Kg	PU
3937.08	small cake = ring ø7,5 cm		9,4		4,5	0,8	0,08	6
3077.06	Heart ø 6 cm	6			4	0,8	0,06	6
3079.06	Heart ø 6 cm	6			4,5	0,8	0,05	6
3079.07	Heart ø 7 cm	7			4,5	0,8	0,06	6
3094.05	Heart ø 3,25	3,25			2	0,8	0,02	6
3070.06	Octogonal ø 6 cm	6			4	0,8	0,05	6
3139.06	Small indiv. square ring, rounded angles		6	6	4	0,8	0,05	6
3138.07	Small ind. rect. ring, rounded angles		7	5	4	0,8	0,05	6
3103.06	Small individual rounded square ring		6	6	4	0,8	0,05	6
3106.06	Small individual rounded triangle ring		6	6	4	0,8	0,05	6
3027.08	Individual		8	5	4	0,8	0,05	6
3101.08	Small individual rounded tear-drop ring		8		4	0,8	0,05	6

The individual shapes are made of stainless steel and used to make small cakes, mousses, individual cream cakes.

Stainless steel pusher for individual pastry rings and forms



Code	Designation	Øcm	Lcm	Wcm	Hcm	Kg
3006.01	Pusher for round ring ø 7.5 - 8 cm	7,4			6,1	0,05
3006.02	Pusher for square pastry form 8 cm		7,7		6,1	0,04
3006.03	Pusher for rectangular tartlet ring (except 3943.05)		7,7	2,4	6	0,02
3006.04	Pusher for oblong rings L. 14 cm		14	3,2	6,1	0,03
3006.05	St/steel pusher for individual form Calisson		10,5	4	6,1	0,03

Stainless steel universal pusher for using in individual pastry rings



Code	Designation	Lcm	Wcm	Hcm	Th.mm	Kg
3006.00		6	7	10	1	0,04

Pushing tool for using in round, triangular or square ring 8 cm, and in rectangular forms 3943/3942/3941. To push easily the sweet or savory preparations in the edges, to pack down regularly avoiding air bubbles and to equalize. Double-ended. Perfect for moulding rice, purée, mousse, cooked vegetables, etc.

Polypropylene precut sheets - 60 microns - Professional size



Code	Designation	Lcm	Hcm	Kg
042010	For cakes ø 60 mm and Ht 45 mm 500 sheets	20	4,5	0,25
042011	For cakes ø 65 mm and Ht 40 mm 500 sheets	21,5	4	0,23

The transparent polypropylene sheet is for lining cake moulds in order to ensure easy turning out after cream cakes have been chilled. These pre-cut linings match the Fab'Rapid shapes or other individual rings and allow even better productivity.

Plastic confectioner's ribbon (200 m) - 150 microns - Professional size



Code	Designation	Hcm	Kg
042002	40 mm high	4	1,65
042003	45 mm high	4,5	1,8
042004	50 mm high	5	2,14
042005	60 mm high	6	2,17

Cake-moulding tapes let you line the insides of pastry rings before moulding cream cakes in them. They then make it easy to turn out the frozen cake without damaging the exterior.

Polypropylene confectioners' ribbon - 60 microns



Code	Designation	Øcm	Lcm	Wcm	Hcm	Kg
042016	Set of 100 strips For lining cakes until max. ø8cm Delivered in decorated box		27	4,5		0,06
	10-meter roll					
042024	Ht 45 mm	5,2			4,5	0,03
042026	Ht 60 mm	5,2			6	0,04

The transparent polypropylene sheet is for lining cake moulds in order to ensure easy turning out after cream cakes have been chilled.

Stainless steel "Bordelais" fluted moulds



Code	Designation	Øcm	Hcm	Th.mm	Kg
3065.35		3,5	4	0,8	0,03
3065.45		4,5	4,2	0,8	0,04
3065.55		5,5	5,5	0,8	0,06



Copper "Bordelais" fluted moulds



Code	Designation	Øcm	Hcm	Liters.	Th.mm	Kg
TINNED COPPER						
6820.35N		3,5	3,3	0,03	0,8	0,01
6820.45N		4,5	4,2	0,06	1	0,03
6820.55N		5,5	5	0,1	1,2	0,05

These moulds allow to use the traditional method for making Bordeaux's famous crunchy Canelé cakes. The copper ensures perfect heat convection for a good caramelization of the juices and a delicious taste.

Crème-caramel mould "dariole", stainless steel



Code	Designation	Øcm	Hcm	Liters.	Th.mm	Kg	PU
3095.45N		4,8	4	0,05	0,8	0,04	6
3095.55N		5,5	5,1	0,14	0,8	0,06	6
3095.65N		6,4	6	0,18	0,8	0,08	6
3095.80		8	7,6	0,32	0,8	0,12	6

The "Dariol" mould is made from extra-smooth stainless steel for easy turning out; this way, the product has a really nice appearance when turned out. The mould is sturdy and will not distort. The shape is perfect for caramel creams.

Hemispherical dome mould, stainless steel



Code	Designation	Øcm	Hcm	Liters.	Th.mm	Kg	PU
3133.04N		4	2	0,02	1,2	0,02	10
3133.06N		6	2,7	0,05	1	0,03	5
3133.07N		7	3,5	0,08	1	0,06	5
3133.08N		8	4	0,13	1	0,08	5
3133.09		9	4,2	0,16	1	0,09	5
3133.10N		10	4,8	0,25	1,2	0,13	5
3133.12		12	5,9	0,45	1,2	0,19	3
3133.14N		14	6,7	0,67	1,2	0,24	3
3133.16N		16	8	1	0,8	0,33	3
3133.18N		18	8,7	1,46	1,5	0,37	2
3133.20N		20	10	2,06	1,5	0,45	2

The various pastry ring shapes allow a pastrycook to make cakes which are good-looking and original, enabling him or her to stand out from the crowd. What's more, the original shape of the cream cake is itself decorative and therefore cuts back on decorating time. The st. steel ring keeps its shape throughout its use but is not too thick for good heat convection during cooking.

FABIEN PAIRON - MOF Charcutier-Traiteur

Teacher at the hotel school from Lausanne

(Ecole Hôtelière de Lausanne)

M. Pairon imagined, designed and worked on an innovative rectangular mould for "Pâté en Croûte" (meat pie):

- Practical, functional and efficient.
- Easy forming, filling, removal and storage.
- Multiuse : Pâté Croûte (rectangular meat pie), sweet and savory cakes, special breads, ginger bread , etc.
- Developed and manufactured by de Buyer in France.



Foldable stainless steel rectangular baking mould GEOFORME



Code	Designation	Lcm	Wcm	Hcm	Liters.	Kg
PERFORATED MODEL						
3210.24		24	5	6		0,55
3210.35		35	7	7,5		0,93
3210.48	Professional size only	48	9	8,5		1,28
PLAIN MODEL						
3211.24		24	5	6	0,7	0,7
3211.35		35	7	7,5	1,8	1,14
3211.48	Professional size only	48	8	8,5	3,6	1,56

Product developed in collaboration with a professional to design the first foldable mould whose fastening system can not be lost.

The perforated model allows even cooking of the dough.

Perfect for PATE EN CROUTE (meat pies), but also for breads, brioches, ginger breads or cakes.

Can be associated with baking paper for oven cooking.

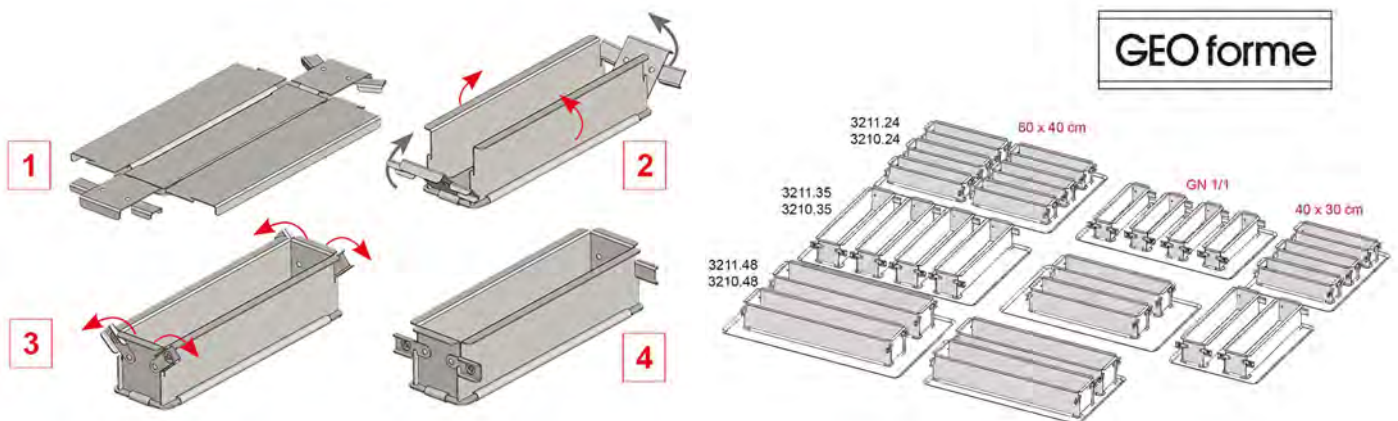

JÉRÔME LANGILLIER MAÎTRE PÂTISSIER
 WORLD CHAMPION 2009
 International consultant
 Member of the Organizing Committee of the World Pastry Cup
 Founding member of the International Desserts Academy



St/steel tube mould with its nonstick baking sheet - Concept Jérôme Langillier



A stainless steel long mould combined with a baking support. Mould: Robust. Heavy duty st/steel. Easy to assembly with the removable ends. Nonstick baking sheet made of PTFE-coated glass fiber. 0,13-mm thick. Reusable over 200 times. Fits perfectly into the mould. Easy moulding and unmoulding. Time saving and higher productivity. For sweet and savory preparations.
 Use temperature: from -170°C to +260°C.

Code	Designation	Øcm	Lcm	Wcm	Th.mm	Kg
	Perfect for baba, Terrines and leavened doughs with yeast Removable ends					
3203.20	Tube mould L.20 cm & baking sheet	4,5	20		0,8	0,25
4344.30	Baking sheet for 3203.20		20	15,1		0,01
3203.30	Tube mould L.30 cm & baking support	4,5	30		0,8	0,33
4344.31	Baking sheet for 3203.30		30	15,1		0,01



St/steel oblique mould special Cake & baking sheet - Concept Jérôme Langillier



Code	Designation	Lcm	Wcm	Hcm	Th.mm	Kg
3208.23	Oblique long mould and baking sheet Removable ends	23	5,5	5	0,8	0,34
4344.40	Baking sheet for 3208.23 from - 170°C to + 260 °C		35	15,5		0,01

Mould: Robust. Heavy duty st/steel. Easy to assembly with the removable ends. Nonstick baking sheet made of PTFE-coated glass fiber. 0,13-mm thick. Reusable over 200 times. Fits perfectly into the mould. Cut to the shape of the mould and can be used as a template for pastry. Easy moulding and unmoulding. Time saving and higher productivity.

St/steel mould special Pâté en Croûte & baking sheet - Concept Jérôme Langillier



Code	Designation	Lcm	Wcm	Hcm	Th.mm	Kg
3202.04	Rectangular mould and baking sheet Removable ends	30	4	6	0,8	0,45
4344.20	Baking sheet for 3202.04 from - 170°C to + 260 °C	44	17			0,01

Mould: Robust. Heavy duty st/steel. Easy to assembly with the removable ends. Nonstick baking sheet made of PTFE-coated glass fiber. 0,13-mm thick. Reusable over 200 times. Fits perfectly into the mould. Cut to the shape of the mould and can be used as a template for pastry. Easy moulding and unmoulding. Time saving and higher productivity.

St/steel triangular cake mould with lid & silicone insert - CREATION C.RENOU



Code	Designation	Lcm	Wcm	Hcm	Kg
3209.18		18	8	6,5	0,65

For the MOF competition, C. Renou decided to work on the theme of "Sweet Picasso" especially on the painter's cubist influences. For this product, a silicone insert with geometric forms in relief fits into the mould and creates a 3D decoration on the cake.



St. steel long round mould with removable ends - Professional size



Code	Designation	Lcm	Wcm	Hcm	Th.mm	Kg
3206.80		50	8	6,5	1	0,85
3206.58	SPECIAL 60 x 40 cm	58	8	6,5	1	0,95

Ideal for making pâtés (with one or two flavours), Yule logs, Swiss rolls, etc. The walls are extra-smooth and turning out is easy. Both end plates are removable.

Rounded mould for rolled-cake, ice-cream or terrine, watertight - professional size



Code	Designation	Lcm	Wcm	Hcm	Th.mm	Kg
3050.80N	Round long mould	50	8	6,2	0,8	0,73
3081.08	Separator for rounded terrine mould		8	6	1	0,06
3050.08	Flat bottom for rounded terrine mould 3050.80	49,5	5,1	5	1,2	0,26

These stainless steel troughs are leakproof, robust, hygienic, and have an original shape. They are ideal for making pâtés (with 1 or 2 flavours), ice-creams (Neapolitan style), etc. Good sealing is important for ice-cream or fish-pâté. The walls are extra-smooth and turning out is easy.

Stainless steel long mould for yule log with removable ends - L. 30 cm

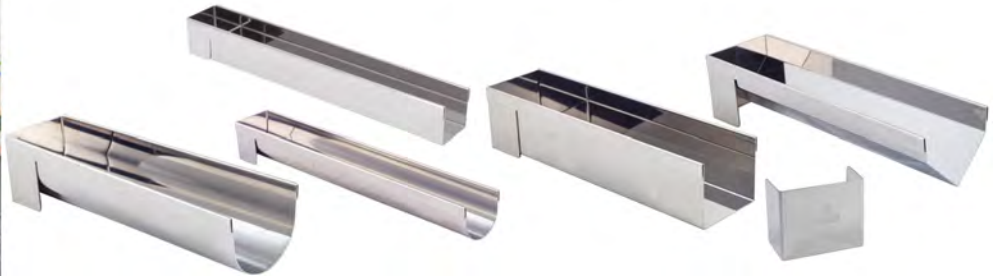

To make pâtés (of vegetables, meat or fish), ice-creams, Swiss rolled, yule logs, etc. Long mould with removable ends. High-quality stainless steel. Made in France.

Code	Designation	Øcm	Lcm	Wcm	Hcm	Kg
3206.30	Round 6,5 cm high	7,5	30	6,5	0,6	
3206.04	Round - small size 4 cm high	4	30	4,4	4	0,21
3205.30	Square		30	6,5	6,5	0,66
3205.04	Square - Small size 4 cm		30	4	4	
3204.30	Triangular		30	8	6,5	0,55

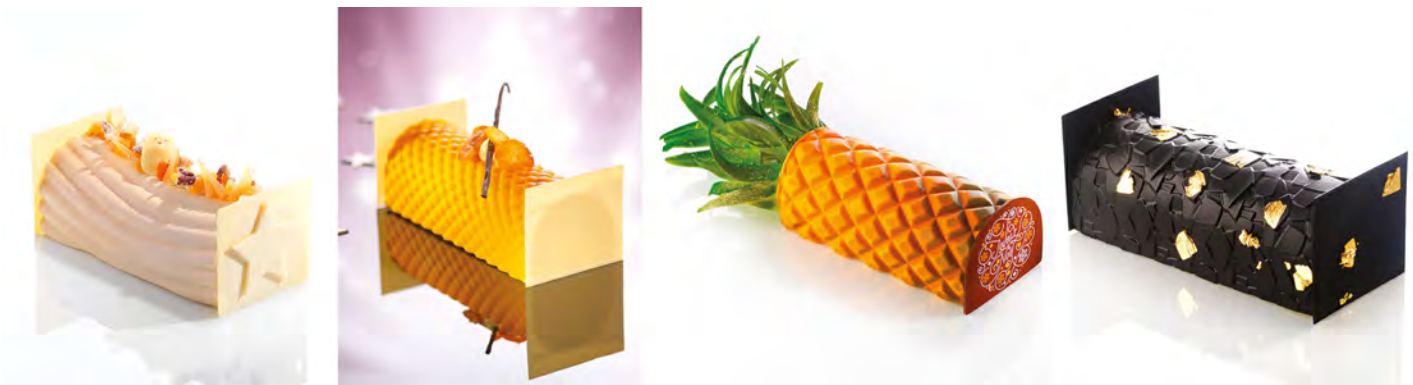

4 supplé plastic sheets in relief for cream cake decoration

**new
2019**



Code	Designation	Lcm	Wcm	Kg
4343.00	For yule log 3206.30	30	18,5	0,1

The supplé plastic sheet is to place in the mould for rolled-cake or in the pastry frame before making your cream cake.
An original relief decoration on the cake is obtained after freezing.
4 patterns are available.
No oven cooking. No dishwasher
MADE IN FRANCE

St. steel plate moulds for small yule logs with removable end - 6 bands



Code	Designation	Lcm	Wcm	Hcm	Kg
4582.03	Round mini yule logs - 6 bands 38x4x4 cm	38	30	4	1,85

These batteries of mini-troughs are made from stainless steel and let you make mini Yule logs, pâtés, etc. Each battery has 6 troughs. The end plates are removable.

Professional Charlotte mould, no lid - Stainless steel



Code	Designation	Øcm	Hcm	Liters.	Kg
3125.07		6,7	4,5	0,14	0,07
3125.10		9,7	6	0,4	0,13
3125.14		14	8	1	0,27
3125.16		16	9	1,5	0,36
3125.18		17,7	10	2,1	0,43
3125.20		19,8	11	3	0,52
Glass lid Ref.3429 are suitable to the Charlotte moulds ø 14-16-18-20 cm					

The charlotte mould, with its high sides, is ideal for all sorts of preparations: Charlottes, plum duff, aspic jellies, ice-creams... The two handles allow a firm hold for easy turning out. Stainless steel guarantees good heat transmission and easy cleaning. The corresponding lid ref. 3429 or 4112 is sold separately.



La Pâtisserie

Cutters

Box of cutters made of polyamid reinforced with glass fibre

Extra-strong foodgrade quality
 Solid and resistant. One-piece construction for perfect hygiene
 Can be sterilized - T° max. 160°C
 35 mm high - Round edge for comfortable handling

Box of 9 round cutters



Code	Designation	Hcm	Kg
4308.00	Plain ø 2 to 10 cm	5	0,23
4307.00	Fluted ø 2 to 10 cm	5	0,22
	ø20/30/40/50/60/70/80/90/100 cm		

Box of 7 oval cutters

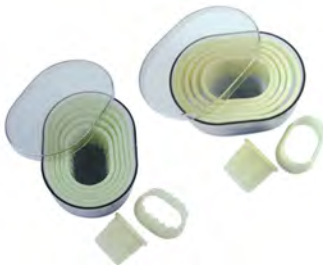

Code	Designation	Hcm	Kg
4302.00	7 plain cutters L. 1,8 cm to 11 cm	5	0,22
4302.10	7 fluted cutters L. 1,8 cm to 11 cm	5	0,22
	L.32/45/58/70/85/95/110 mm		

Box of 7 cutters "BOAT"



Code	Designation	Hcm	Kg
4300.00	7 plain cutters L. 2 cm to 11 cm	5	0,17
4300.10	7 fluted cutters L. 2 cm to 11 cm	5	0,18
	L.20/35/50/65/80/95/110 mm		

Box of 7 cutters "HEART"



Code	Designation	Hcm	Kg
4301.00	7 plain cutters L. 1,5 cm to 9,5 cm	5	0,24
4301.10	7 fluted cutters L. 1,5 cm to 9,5 cm	5	0,23
	15/25/45/55/65/80/95 mm		

Box of 8 cutters "FLOWER"



Code	Designation	Hcm	Kg
4303.00	8 plain cutters plain cutters ø 1,8 to 11,5 cm	5	0,28
4303.10	8 fluted cutters ø 2 to 10 cm	5	0,28
	ø 18/30/45/60/75/85/100/115 mm		

Box of plain cutters

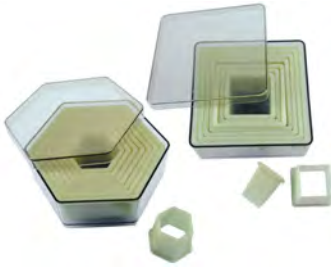

Code	Designation	Hcm	Kg
4304.30	9 square cutters - L.1,8 to 9,5 cm L.18/25/35/45/55/65/75/85/95 mm	5	0,27
4304.40	9 hexagonal cutters - ø 1,5 to 9 cm ø15/25/35/45/50/60/70/80/90 mm	5	0,25

Box of plain cutters



Code	Designation	Hcm	Kg
4304.70	8 cutters "Clover" - ø 1,5 to 10 cm ø 15/30/40/50/65/75/90/100 mm	5	0,26

Box of plain cutters



Code	Designation	Hcm	Kg
4304.20	7 cutters "Moon" - L. 7 to 11 cm L.70/80/85/90/95/100/110 mm	5	0,29

Oval fluted cutter with handle



Code	Designation	Lcm	Wcm	Hcm	Th.mm	Kg
3312.17	St. steel oval fluted cutter L. 17 cm	17	12,5	3,5	0,4	0,23

This professional-grade pastry cutting ring is very sturdy and will not distort. The ergonomic handle gives a good grip without risk of injury.

Box of 9 round cutters - stainless steel



Code	Designation	Hcm	Th.mm	Kg
3323.00N	Plain ø 3 to 11 cm	3,5	0,6	0,44
3324.00N	Fluted ø 3 to 11 cm	3,5	0,6	0,46

These professional-grade stainless steel star pastry cutting rings are very sturdy and will not distort. They will satisfy every need thanks to the different forms available. It is the tool which will satisfy your creativity thanks to the 2 different aspects suggested.

Rolling pins



Code	Designation	Øcm	Lcm	Kg
4880.00N	"Makrolon" polyamide rolling pin (1)	5	50	0,92
4840.01N	Beech rolling pin (2)	5	50	0,72

The polyamide rolling pin is ideal for making puff pastry; it has the advantage of staying at a constant temperature so pastry won't stick.

Rolling pin aluminium, on ball bearings



Code	Designation	Øcm	Lcm	Wcm	Kg
8800.46N		8	46	7,5	1,5

This professional rolling pin has bearings to allow smooth rotation, giving easy, effortless use.

Wheels for pastry in food plastic material



Code	Designation	Øcm	Lcm	Kg
	Cutting wheel for grating pastry			
4361.00N		4,5	5	0,07
4361.01N		4,5	10	0,14
	Spiked roller			
4362.00N		6,5	5	0,07
4362.01N		6,5	10	0,14

The criss-cross slitter lets you make diamond holes in the pastry for decorating pie-tops. Once the pastry has been through the roller, you just need to stretch it to obtain perfect diamond holes. The pastry-spiking roll is handy for pricking holes quickly and uniformly in strips of pastry.

Set of 10 disposable baker blades



Code	Designation	Lcm	Kg
4670.03N	Yellow baker blades : fixed blades	13	0,01
4670.04N	Red baker blades : pivoting blades	13	0,01
4670.05N	Blue baker blades : reversible blades	14	0,01
4670.06N	Green baker blades : fixed blades	14,5	0,01

Baker's blades let you slit the dough before baking bread. The blade's cutting edge guarantees you a high quality cut.

Scraper



Code	Designation	Lcm	Wcm	Hcm	Th.mm	Kg	PU
3300.12	Straight dough scraper, stiff, st. steel	12	9	2,5	1	0,18	1
3301.12	Round dough scraper, stiff, st. steel	12	9	2,5	1	0,14	1
3302.11N	Dough straight scraper, supple steel	11	8,8	2,5	0,3	0,09	12
3302.12N	Dough round scraper, supple steel	11	8,8	2,5	0,3	0,08	12

The rigid or flexible pastry cutters are used for cutting out and cleaning pastry, bread dough, or pizza pastry, and also for scraping

Supple plastic scraper



Code	Designation	Lcm	Wcm	Th.mm	Kg	PU
4858.00N	Supple round scraper T° max. 60 °C	15	11	2	0,02	5

This utensil lets you scrape out a bowl to remove any mixture stuck to the walls.

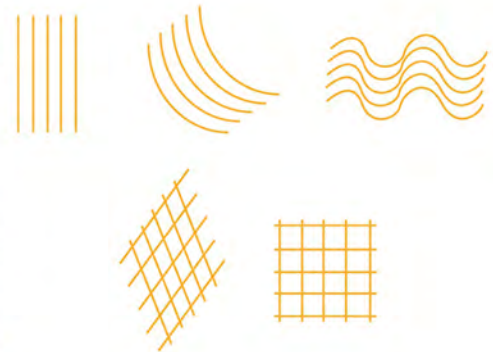

Expanding pastry cutter - Stainless steel



This expanding roller carries several stub spindles, each with a cutting wheel, and allows you to cut a series of straight strips in one go. The width is adjustable.

Code	Designation	Lcm	Wcm	Hcm	Kg
4781.00N	5 plain wheels ø 5,5 cm to cut 4 strips From 1 to 11,5 cm large	22,5	5,2	5,5	0,56
4781.01	Double 5 plain wheels and 5 fluted wheels ø 5,5 cm to cut 4 strips From 1 to 11,5 cm large	27	7,8	5,5	0,97
4781.02	6 plain wheels ø 10 cm to cut 5 strips From 1 to 12,5 cm large	27	6,4	10	0,98



Imitation wood pattern combs - Rubber

Code	Designation	Lcm	Kg
40509	Individual imitation wood pattern L. 100 mm	10	0,1
40510	Individual imitation wood patterns L. 150 mm	15	0,17



The grainer is a half-round rubber utensil used in pastry cooking to give a decorative imitation wood effect to cakes and cream cakes.

St. steel frame and comb for biscuit "Charlotte" and decorating cream comb 2 sides

Code	Designation	Lcm	Wcm	Hcm	Th.mm	Kg
3003.42	Decorating cream comb 2 sides (1)	42	8		1,2	0,31
3017.70	St. steel comb, 2 sides (2)	70	11	2,5	1,2	0,8



The frames allow you not only to size the mix but also to guide the comb when you pull it towards you to make a decoration on biscuit or cream.

Pastry frame, stainless steel

Code	Designation	Lcm	Wcm	Hcm	Th.mm	Kg
3015.36	For tray 40x 30 cm	36	26	4,5	2,5	1,1
3015.25		57	37	2,5	2,5	0,8
3015.30		57	37	3		
3015.35		57	37	3,5	2,5	1,12
3015.40		57	37	4	2,5	1,4
3015.45		57	37	4,5	2,5	1,6
3015.49	For GN 1/1 size	49	29	4,5	2,5	
3015.50		57	37	5	2,5	1,86
3015.60		57	37	6	2,5	2,19



These stainless steel biscuit frames are extra thick and will not distort. They are easy to keep clean.

Stainless steel "Joconde" biscuit frame

Code	Designation	Lcm	Wcm	Th.mm	Kg
	(Interior size)				
3017.61	"Joconde" frame" 570 x 370 mm	61	41	3	1,25



This biscuit frame is 3mm thick (just over 1/8") and is specially designed for making Joconde biscuits.

Pastry frame st. steel



Code	Designation	Lcm	Wcm	Hcm	Th.mm	Kg
3018.30		57	9	3	2,5	0,77
3018.40		57	9	4	2,5	1,04
3018.49	For GN 1/1 size	49	9	4,5	2,5	

These stainless steel biscuit frames are extra thick and will not distort. They are easy to keep clean.



Stainless steel expandable square frame

new 2019

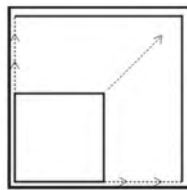

Stainless steel expandable rectangular frame

new 2019

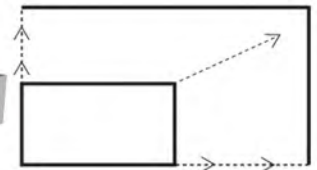

Code	Designation	Lcm	Wcm	Hcm	Th.mm	Kg
3013.16	Max. size 30x30 cm	16	16	5	1	0,57
3013.20	Max. size 37x37 cm Perfect for trays 40x30cm	20	20	5	1	0,69
3013.30	Max. size 5 x57 cm	30	30	5	1	0,82

Code	Designation	Lcm	Wcm	Hcm	Th.mm	Kg
3013.21	Exp.to maxi. 40x21cm	21,5	11,5	7,5	1	1,07
3013.43	Exp.to maxi. 56 x84cm	43	29	5	1	1,29

Setting & maintaining the size thanks to side. Waterproof on a flat baking support. Perfect result thanks to the smooth inner

St. steel straight "Génoise" mould, watertight



Code	Designation	Lcm	Wcm	Hcm	Th.mm	Kg
4770.40		40	30	5	1	1,4
4770.53	GN 1/1	53	32	5	1	1,85
4770.60		59	39	5	1	2,53

The straight-sided sponge cake mould is leakproof and lets you make biscuits, flans, rice puddings, etc. Being made from stainless steel, it is perfectly hygienic and easy to keep clean.

Punch and coulis bottle



Code	Designation	Øcm	Lcm	Wcm	Hcm	Liters.	Kg
044080N	Coulis bottle		4	4	12	0,25	0,03
044085N	Punch bottle with plug	8			29	1	0,11

Made from food-grade plastic, the punch doser has a perforated cap for soaking biscuits. The coulis doser has a pouring nozzle.



St. steel "raplette" spreader - Adjustable in width and height

Code	Designation	Lcm	Wcm	Hcm	Th.mm	Kg
3002.01	Equipped with removable decorating double comb	40	17	6	1,5	0,92
3002.00	Without decorating double comb	40	17	6	1,5	0,91
3002.99	Decorating double comb with teeth Removable - with 2 different shapes	40			1,5	0,22



The Pascal spreader lets you spread out cream or chocolate with a single action. A special feature is its adjustable width and height. These allow you to make very thin layers. Use it with or without its detachable cream-comb teeth. The cream-comb has two different triangular tooth spacings. The spreader is also handy for preparing chocolate shavings.



Bain-marie cooker



The bain-marie cooker consists of a hollow stainless steel shell in which water is heated. It enables you to heat at lukewarm temperatures for melting chocolate or keeping sauces warm. It has a handle, which makes it easy to use. For all heat sources, including induction hobs.

Code	Designation	Øcm	Hcm	Liters.	Th.mm	Kg
3437.16N	With handle and double st. steel body	16	12,5	1,5	1	0,97

Set of 10 stainless steel chocolate forks



Code	Designation	Lcm	Wcm	Kg
4347.40		21	8	0,33

The stainless steel chocolate forks have a handle made of polypropylene. The box includes 10 forks.

Professional stainless steel levelling frame Ht 3 to 12 mm



Code	Designation	Lcm	Wcm	Th.mm
3085.05	5 mm	33,7	33,7	5
3085.08	8 mm	33,7	33,7	8
3085.10	10 mm	33,7	33,7	10
3085.12	12 mm	33,7	33,7	12

These stainless steel frames are very easy to keep clean. They let you make slabs of cream filling, chocolate, marzipan, fruit paste, etc. Five different frame heights are available.

Chocolate Girolle



Code	Designation	Øcm	Hcm	Kg
40466	Chocolate "girolle" - Base and crank	22	15	0,24

The chocolate leafmaker is made from food-grade plastic. With a turn of the handle it lets you make light, appetizing, decorative leaf-curls: give it a full or half turn to make one chocolate leaf-curl. Remove the handle and place the decoration on the cream cake. The leafmaker can also be used for cheese.

Sweet maker - Coating system



Code	Designation	Øcm	Kg
3500.00		40	4,2
	Created by Pascal Brunstein		
	Ruban Bleu 1997		

The sugar coater enables dried fruits (almonds, hazelnuts, walnuts, etc.) to be sugar coated or to be covered with chocolate, marzipan... 6 to 8kg (13-18lbs) of sweets or candies can be made in 30 minutes.

Improved fastening system.

The stainless steel double bell fits onto beaters :

- KITCHENAID K5 Super Plus
- KITCHENAID ARTISAN PRO
- Dito Sama BE5 A
- Dito Sama 3500.00

Plastic sheets for chocolate - Professional size 60x40 cm

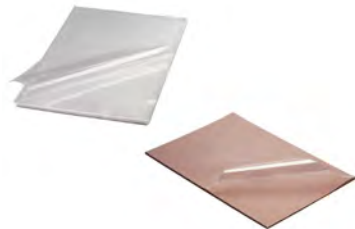

Code	Designation	Lcm	Wcm	Kg
042030	25 icing paper sheets for transfers 175 microns	60	40	1,8
042031	100 polyethylene sheets for wire cutter 150 microns	60	40	3,38

Rhoidoid glazing sheets are for use as a backing sheet for chocolates or cream filling or butter cream designs. They enable transfers to be applied to the top or the base of a cream cake.

Set of 5 polyethylene sheets for chocolate work



Code	Designation	Lcm	Wcm	Kg
042032		30	20	0,02

Cold use.

Gold patterns



Code	Designation	Lcm	Wcm
076100	Book of 25 Gold sheets	8	8

This food-grade product lets you put a gold decoration on chocolates.



Sugar saucepan, massive copper, 2 spouts and st. steel cold handle

Code	Designation	Øcm	Hcm	Liters.	Th.mm	Kg
6572.20		20	11	3,4	2	1,8



This sugar saucepan with two pouring lips (for left- or right-handed people) has a stainless steel handle that remains cold so as not to burn the user's hand.

Copper massive conical jam pans with cast-iron handles

Code	Designation	Øcm	Hcm	Liters.	Th.mm	Kg
6200.38N	Conical jam pan, 1 mm th	38	15	9	1,2	1,5
6202.40N	Conical jam pan, 2 mm th	40	14,4	12	1,7	3,4



Candy thermometer +80°C / +200°C with stainless steel case

Code	Designation	Øcm	Lcm	Kg
4884.01N	PRECISION 1/1	0,2	27,5	0,1



This thermometer is used for pastry and candy. It is calibrated to allow for immersion of the lower thinner part of the stem. The protective sleeve can be sterilized at 100°C. The thermometer and sleeve can be washed in a dishwasher.

Squeeze pump for sugar blowing, made of rubber and copper

Code	Designation	Lcm	Kg
4665.00N		9	0,07



Sugar blowing is rather like glass blowing and requires a pump like this one.

Pastry nozzles made of TRITAN.

Transparent black colour.
 Solid - One-piece construction.
 Perfectly smooth cone for guaranteed hygiene.
 The reinforced teeth on the fancy nozzles make high accuracy work.
 The nozzles are long enough, making them easier to insert in the bag and giving them better visibility.
 They all fit with LE TUBE de Buyer and are dishwasher friendly.
MADE IN FRANCE



Plain nozzle - Tritan

**new
2019**



Code	Designation	Øcm	Hcm	Kg
4151.03	ø 3 mm - U2	3,5	6	0,01
4151.06	ø 6 mm - U4	3,5	6	0,01
4151.08	ø 8 mm - U6	3,5	6	0,01
4151.11	ø 11 mm - U8	3,5	6	0,01
4151.13	ø 13 mm - U10		6	0,01
4151.15	ø 15 mm - U12	3,5	6	0,01
4151.18	ø 18 mm - U14	3,5	6	0,01

'Petit Four' star nozzles - Tritan

**new
2019**



Code	Designation	Hcm	Kg
4156.10	PF10 ø 10 mm - 14 teeth	6	0,01
4156.14	PF14 ø 14 mm - 16 teeth	6	0,01
4156.18	PF18 ø 18 mm - 18 teeth	6	0,01





Tritan Star nozzle

**new
2019**



Code	Designation	Øcm	Hcm	Kg
4152.05	A8 - ø 3 mm	3,5	6	0,01
4152.09	B8 - ø 5 mm	3,5	6	0,01
4152.11	C6 - ø 8 mm	3,5	6	0,01
4152.13	C8 - ø 8 mm	3,5	6	0,01
4152.17	D8 - ø 11 mm	3,5	6	0,01
4152.19	E6 - ø 13 mm	3,5	6	0,01
4152.20	E8 - ø 13 mm	3,5	6	0,01
4152.25	F8 - ø 18 mm	3,5	6	0,01

Saint Honoré nozzle - Tritan

**new
2019**



Code	Designation	Øcm	Hcm	Kg
4155.09	ø 9 mm	3,5	6	0,01
4155.11	ø 11 mm	3,5	6	0,01

The spout has a cut-out. They are used for dressing Saint-Honorés with cream. They do a much better job than a spoon.



Star ribbon nozzle - Tritan

**new
2019**



Code	Designation	Øcm	Hcm	Kg
4153.08	8 points - hole 19 x 2 mm	3,5	6	0,01

One flat side and one indented side for decorating Yule logs.



Bird nest nozzle - Tritan

new
2019



Code	Designation	Øcm	Hcm	Kg
4166.01	19 holes ø3 mm	3,5	4,5	0,01



Leaf nozzle - Tritan

new
2019



Code	Designation	Øcm	Hcm	Kg
4168.02	F2	3,5	6	0,01



Garnishing nozzles - Tritan

new
2019



Code	Designation	Øcm	Hcm	Kg
4165.06	Nozzle ø 6 mm	3,5	9	0,01
4165.10	Nozzle ø 10 mm	3,5	9	0,01



GEO nozzle - Tritan

new
2019



Code	Designation	Øcm	Hcm	Kg
4183.05	Square 5 mm	3,5	6	0,01
4183.10	Square 10 mm	3,5	6	0,01
4181.10	Triangular 10 mm	3,5	6	0,01
4182.12	Rectangular 12 x 6 mm	3,5	6	0,01
4180.14	Half ø 14 mm	3,5	6	0,01

EXCLUSIVITY DE BUYER

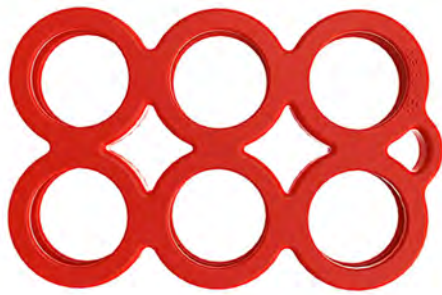

Box of 6 Tritan nozzles and supple holder

**new
2019**



Code	Designation	Lcm	Wcm	Hcm	Kg
4150.02	Set CLASSIC - 3 plain nozzles ø 6-11-13 mm - 3 Star nozzles B8-C6-E8	16,5	8,5	7	0,1
4150.03	Set CREATIVE - 2 Star nozzles PF10 - PF14 / 1 leaf nozzle - 1 ribbon nozzle / 1 bird nest / 1 St Honoré ø 9 mm	16,5	8,5	7	0,1
4150.05	Set GEO - 1 plain nozzle ø 8 mm - 5 GEO : 2 squares / triangle / rectangle / hemisphere	16,5	8,5	7	0,1
4150.07	Set STARTER - 3 plain nozzles ø 3-8-15 mm - 3 Star nozzles A8-C8-F8	16,5	8,5	7	0,1
4150.08	FILLING set - 1 plain nozzle ø11 mm / 2 Star nozzles PF10 - PF14 - 2 filling nozzles ø 6-10 mm / 1 GEO rectangular nozzle	16,5	8,5	7	0,1

Box supplied with an holder made in TPE for 6 nozzles Tritan. Equipped with a hole to hang. Nozzles are easy to clip, unclip, clean, dry and store. No nozzle gets lost.

Box of 12 Tritan nozzles and 2 supple holders

**new
2019**



Code	Designation	Lcm	Wcm	Hcm	Kg
4150.04	SET MIX (4150.02+4150.03) - 3 plain nozzles ø 6-11-13 mm - 3 Star nozzles B8-C6-E8 - 2 Star nozzles PF10 - PF14 / 1 leaf nozzle - 1 ribbon nozzle / 1 bird nest / 1 St Honoré ø 9 mm	21	12,5	7	0,18

U2 - ø3mm



U3 - ø4mm



U4 - ø6mm



U5 - ø7mm



U6 - ø8mm



U7 - ø10mm



U8 - ø11mm



U10 - ø13mm



U11 - ø14mm



U12 - ø15mm



U14 - ø18mm



U15 - ø20mm



Stainless steel plain nozzle



Code	Designation	Øcm	Hcm	Kg
2111.02N		0,2	5	0,01
2111.03N		0,3	5	0,01
2111.04N		0,4	5	0,01
2111.05N		0,5	5	0,01
2111.06N		0,6	5	0,01
2111.07N		0,7	4,5	0,01
2111.08N		0,8	4,5	0,01
2111.09N		0,9	4,5	0,01
2111.10N		1	5,4	0,01
2111.11N		1,1	5	0,01
2111.12N		1,2	5	0,01
2111.13N		1,3	5	0,01
2111.14N		1,4	5	0,01
2111.15N		1,5	5,4	0,01
2111.16N		1,6	5,3	0,01
2111.17N		1,7	5,3	0,01
2111.18N		1,8	5	0,01
2111.20N		2	5	0,01
2111.22N		2,2	4,9	0,01
2111.24N		2,4	4,5	0,01

These stainless steel nozzles without welding are robust, easy to clean and hygienic. They fit onto piping bags for making patterns with cream or for filling the hollows in a baking preparation.

Stainless steel star nozzle



Code	Designation	Øcm	Kg
2112.02N	A5	0,3	0,01
2112.03N	A6	0,3	0,01
2112.04N	A7	0,35	0,01
2112.05N	A8	0,5	0,01
2112.06N	B5	0,5	0,01
2112.07N	B6	0,5	0,01
2112.08N	B7	0,6	0,01
2112.09N	B8	0,7	0,01
2112.10N	C5	0,7	0,01
2112.11N	C6	0,7	0,01
2112.12N	C7	0,7	0,01
2112.13N	C8	0,9	0,01

These stainless steel nozzles without welding are robust, easy to clean and hygienic. They fit onto piping bags for making cream patterns or for filling the hollows in a baking mixture.

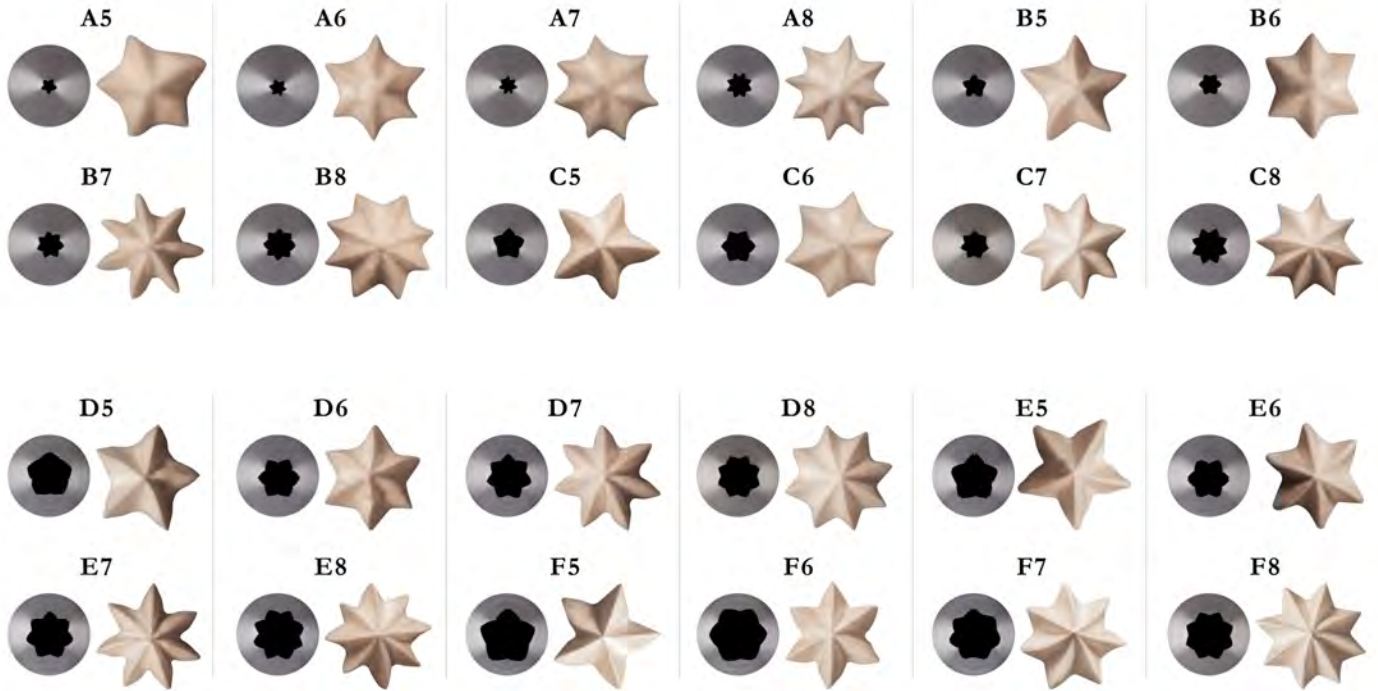

Stainless steel star nozzle



Code	Designation	Øcm	Kg
2112.14N	D5	1,1	0,01
2112.15N	D6	1,1	0,01
2112.16N	D7	1,1	0,01
2112.17N	D8	1,1	0,01
2112.18N	E5	1,3	0,01
2112.19N	E6	1,3	0,01
2112.20N	E7	1,3	0,01
2112.21N	E8	1,3	0,01
2112.22N	F5	1,8	0,01
2112.23N	F6	1,8	0,01
2112.24N	F7	1,8	0,01
2112.25N	F8	1,8	0,01

These stainless steel nozzles without welding are robust, easy to clean and hygienic. They fit onto piping bags for making cream patterns or for filling the hollows in a baking mixture.

Stainless steel ruban nozzle



Code	Designation	Øcm	Hcm	Kg
2117.10	10 x 2 mm	2,5	4,5	0,01
2117.15	15 x 2 mm	3,2	4,5	0,01
2117.20	20 x 2 mm	3,2	4,5	0,01
2117.30	30 x 5 mm	3,6	4,5	0,01



Stainless steel star ribbon nozzle



Code	Designation	Øcm	Hcm	Kg
2113.06N	6 points- hole 16 x 2 mm	2,5	4	0,01
2113.08N	6 points - hole 20 x 3 mm	3	4,5	0,01

These stainless steel nozzles without welding are robust, easy to clean and hygienic. They have one flat side and one indented side and are used for decorating Yule logs.

Stainless steel Sultane nozzle - Small size Ht 4,5 cm

new
2019



Code	Designation	Hcm	Kg
2118.31	Plain	4,5	0,01
2118.12	Star	4,5	0,01

Stainless steel Sultane nozzle



Code	Designation	Hcm	Kg
2118.01	Protruding cone	6,3	0,03
2118.02	Flat cone-up	6,3	0,03

UP : outer ø35 mm
cone inside ø21 mm
ø base 55 mm



Stainless steel Sultane mini nozzle



Code	Designation	Øcm	Hcm	Kg
2118.03	ø 7 mm - 12 teeth	1,8	2,85	0,01

Stainless steel Saint Honoré nozzle



Code	Designation	Øcm	Hcm	Kg
2115.20N		0,9	5,5	0,01
2115.25N		1,1	5,3	0,01
2115.30N		1,3	5,3	0,01
2115.35N		1,5	5,3	0,01
2115.40N		1,6	5,3	0,01

These stainless steel nozzles are robust, easy to clean and hygienic thanks to their watertight "end-to-end" welding. The spout has a cut-out. They are used for dressing Saint-Honorés with cream. They do a much better job than a spoon.

Leaf nozzle, stainless steel



Code	Designation	Hcm	Kg
2128.02N	N° 2 - large 6 mm	6	0,01

These stainless steel nozzles without welding are robust, easy to clean and hygienic.



Rose nozzle, stainless steel - 8 points



Code	Designation	Øcm	Hcm	Kg
2129.08N		0,8	5	0,01
2129.09N		0,9	5	0,01
2129.11N		1,1	5	0,01
2129.14N		1,4	5	0,01
2129.16N		1,6	5	0,01

These stainless steel nozzles without welding are robust, easy to clean and hygienic.

Bird nest nozzle, stainless steel



Code	Designation	Øcm	Hcm	Kg
2126.00N	7 holes ø 1.3 mm	1,3	3,95	0,01
2126.01	9 holes ø 3 mm	1,9	3,95	0,01

These stainless steel nozzles without welding are robust, easy to clean and hygienic.



Bird nest nozzle, stainless steel - 3 fluted holes



Code	Designation	Øcm
2126.02		3,1

These stainless steel nozzles without welding are robust, easy to clean and hygienic.

Stainless steel nozzle - spiral effect



Code	Designation	Øcm	Hcm
2119.13	8 teeth	1,3	4,15

These stainless steel nozzles without welding are robust, easy to clean and hygienic.

Stainless steel 'Petit Four' star nozzles

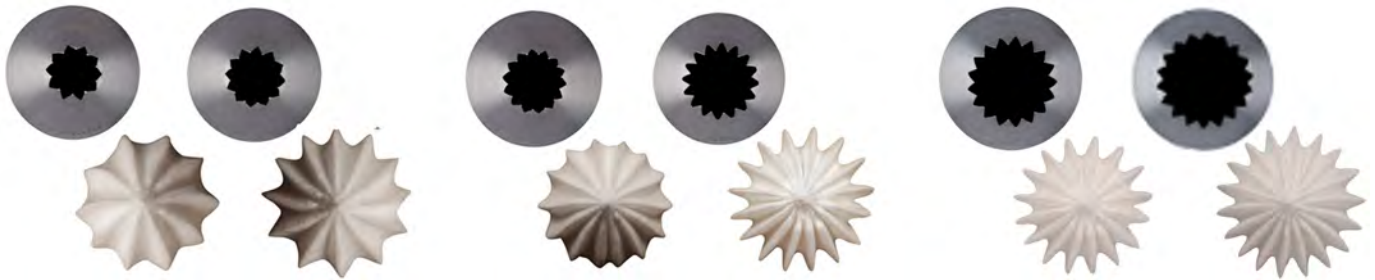

Code	Designation	Hcm	Kg
2116.07	ø 7 mm - 10 teeth	4,8	0,05
2116.08	ø 8 mm - 12 teeth	4,3	0,07
2116.10	ø 10 mm - 14 teeth	5	0,01
2116.14	ø 14 mm - 16 teeth	5,5	0,01
2116.16	ø 16 mm - 17 teeth	5,3	0,08
2116.17	ø 17,5 mm - 18 teeth	4,8	0,05

Sphere nozzle, stainless steel



Code	Designation	Øcm	Kg
2120.20	Sphere with fine streaks	2,5	0,01
2120.21	Sphere with large streaks	2,5	0,01

These stainless steel nozzles without welding are robust, easy to clean and hygienic.



Russian nozzle, stainless steel - Flower decor N°241 - N°242



Code	Designation	Øcm	Hcm
2120.01	N°241	2,67	3,85
2120.02	N°242	2,67	3,85

These stainless steel nozzles without welding are robust, easy to clean and hygienic.

Russian nozzle, stainless steel - Flower decor N°243 - N°244



Code	Designation	Øcm	Hcm
2120.03	N°243	2,67	3,85
2120.04	N°244	2,67	3,85

These stainless steel nozzles without welding are robust, easy to clean and hygienic.

Russian nozzle, stainless steel - Flower decor - N°246 - N°247

Russian nozzle, stainless steel - Flower decor N°257 - N°248



Code	Designation	Øcm	Hcm
2120.05	N°246	2,67	3,85
2120.06	N°247	2,67	3,85

These stainless steel nozzles without welding are robust, easy to clean and hygienic.

Code	Designation	Øcm	Hcm
2120.08	N°248	2,67	3,85
2120.07	N°257	2,67	3,85

These stainless steel nozzles without welding are robust, easy to clean and hygienic.

PASTRY BOX: set of 60 stainless steel nozzles



Code	Designation	Lcm	Wcm	Hcm	Kg
2130.00		17,5	12,9	7,6	0,6

Stainless steel pastry nozzles. Perfectly smooth. Easy cleaning. Dishwasher safe. Suitable for all piping bags.

MAXI PASTRY BOX: set of 120 stainless steel nozzles



Code	Designation	Lcm	Wcm	Hcm	Kg
2130.01	24 differents nozzles in 5 ex - 7 Plain ø 6/8/10/12/14/16/18 mm - 6 Star A8/C6/D6/D8/E8/F8 - 2 Star ribbon 6 teeth L.16 mm - L.20 mm - 2 St Honoré ø 11 mm - ø 15 mm - 2 Petits Fours ø 8 mm - ø 14 mm - Garnishing nozzle ø 6 mm - Bird nest nozzle - Leaf nozzle N°2 - 2 Rose nozzles ø 8 mm - ø 11 mm	28	18,5	8	1,22

Stainless steel pastry nozzles. Perfectly smooth. Easy cleaning. Dishwasher safe. Suitable for all piping bags.

MEGA PASTRY BOX: set of 172 stainless steel nozzles



Code	Designation	Lcm	Wcm	Hcm	Kg
2130.02	35 differents nozzles in 5 ex (except 2120.20 x 2) - 7 Plain ø 6/8/10/12/14/16/18 mm - 6 Star A8/C6/D6/D8/E8/F8 - 2 St Honoré ø 11 mm - ø 15 mm - 2 Star ribbon 6 teeth L.16 mm - L.20 mm - 2 Petits Fours ø 8 mm - ø 14 mm - Garnishing nozzle ø 6 mm - 2 Bird nest nozzles - 2 Rose nozzles ø 8 mm - ø 11 mm - Ruban nozzle L.20 mm - Sphere nozzle - 8 Russian flower nozzles - Spiral effect nozzle	30,5	21,5	8	1,55

Stainless steel pastry nozzles. Perfectly smooth. Easy cleaning. Dishwasher safe. Suitable for all piping bags.

Garnishing nozzles



Code	Designation	Hcm	Kg
2125.06	Nozzle ø 6 mm	8,2	0
2125.03	Set of 3 nozzlesø 4-6-8 mm		0,01

Set of 5 stainless steel nozzles



Code	Designation	Kg
2114.05	in blister package - 2 plain nozzles ø 8 and 2 mm - 1 star ribbon nozzle 8 teeth - Garnishing nozzle ø 6 mm - Star nozzle C6	0,06

Set of 6 stainless steel nozzles



Code	Designation	Kg
2114.00N	Set of 6 st. steel nozzles	0,04

Adapter for nozzles made of foodgrade plastic



Code	Designation	Hcm	Kg
2114.11	Kit for large nozzles ø 35mm	5,8	0,02
2114.12	Kit for medium nozzles ø 25mm	5,7	0,03
2114.21	Kit for decor nozzles ø 20mm	3	0,02
2114.13	Set of 3 adapters for the 3 sizes of nozzles ø 35/25/20 mm		0,1

Adapters enable to change of nozzles on the same pastry bag.

Set of 26 small stainless steel decor nozzles



Code	Designation	Lcm	Wcm	Hcm	Kg
2114.20		19,2	14	4,8	0,27

Case with 26 st/steel decor nozzles + an adaptor + 2 supports to make decorations in chocolate/cream/glaze for writing or creating leaves, flowers, ...
Supplied with an adapter to change nozzles on the same pastry bag.

Set of 35 stainless steel pastry nozzles + 2 adaptators



Code	Designation	Lcm	Wcm	Hcm	Kg
2114.10		30	24	6,3	0,87

Case with a traditional pastry assortment of 35 nozzles:
 - 10 plain nozzles
 - 15 star nozzles
 - 5 nozzles for Petit Four
 - 2 nozzles for Rose
 - 2 ribbon nozzles
 - 1 nozzle to garnish .
 Supplied with adapters to change nozzles on the same pastry bag.

Set of 12 polypropylene nozzles



Code	Designation	Lcm	Wcm	Hcm	Kg
4134.80N		15	12	6,2	0,17

The box contains a selection of the 12 most frequently used confectionery nozzles.

Set of 6 nozzles made of plastic



Code	Designation	Hcm	Kg
4863.01N	3 plain nozzles ø 6/11/18 mm + 3 star nozzles ø 8/11/18 mm	5	0,02

The bare minimum for confectionery use.

Nylon extra supple pastry bags

new
2019



Code	Designation	Lcm	Kg
4859.34		34	0,01
4859.46		46	0,01

The professional re-usable pastry bags made of coated cotton are particularly supple. They have a string, but no hem. They are lined and then watertight.

Cotton pastry bags



Code	Designation	Lcm	Kg	PU
4856.25N	pastry bag 25 cm	25	0,04	6
4856.30N	pastry bag 30 cm	30	0,04	6
4856.35N	pastry bag 35 cm	35	0,05	6
4856.40N	pastry bag 40 cm	40	0,06	6
4856.45N	pastry bag 45 cm	45	0,07	6
4856.50N	pastry bag 50 cm	50	0,11	6
4856.55N	pastry bag 55 cm	55	0,12	6
4856.60N	pastry bag 60 cm	60	0,16	6
4347.05N	Set of 5 cotton pastry bags 30/35/40/45 and 50 cm long		0,13	1

The professional re-usable pastry bags made of coated cotton are particularly supple. They have a string, but no hem. They are lined and then watertight.

Supple pastry bag made of polyurethane



Code	Designation	Lcm	Wcm	Kg
4347.35		35	20	0,02

Foodgrade polyurethane. This innovative material gives to the bag high resistance, flexibility and softness. It has a smooth surface inside which make easier the outflow of the product and rough outside for a better handle. Thanks to a special welding of the bag, a high hygienic safety is guaranteed. Easy cleaning. Dishwasher safe. Resists until 60°C maximum.

Supple pastry bag made of polyurethane + 2 stainless steel nozzles



Code	Designation	Lcm	Wcm	Hcm	Kg
4347.03	Pastry bag L. 35 cm Plain nozzle 2111.10N ø 10 mm Star nozzle C6 Packed in plastic box	24	4	4	0,06

Foodgrade polyurethane. This innovative material gives to the bag high resistance, flexibility and softness. It has a smooth surface inside which make easier the outflow of the product and rough outside for a better handle. Thanks to a special welding of the bag, a high hygienic safety is guaranteed. Easy cleaning. Dishwasher safe. Resists until 60°C maximum.

Roll of 20 disposable pastry bags - Polyethylene



Code	Designation	Øcm	Lcm	Wcm	Kg
4348.02		4	23	4	0,14
	Delivered in decorated box				

The throw-away piping bags have the same use as the nylon ones but without the inconvenience of cleaning and upkeep. Reinforced edges. T° 70°C max.

Roll of 100 disposable pastry bags - Blue polyethylene



Code	Designation	Lcm	Liters.	Kg
4349.55		55	1,7	1,35

90 microns. Reinforced edges. T° 70°C max. Roll in a dispenser box.

Roll of 100 disposable pastry bags - Polyethylene



Code	Designation	Lcm	Liters.	Kg
4348.30N	30 cm long	30	0,25	0,6
4348.40N	40 cm long	40	0,5	0,95
4348.45N	45 cm long	45	0,75	1
4348.50N	50 cm long	50	1,25	1,2
4348.01N	55 cm long	55	1,7	1,35
4348.60N	60 cm long	60	1,8	1,45

The throw-away piping bags have the same use as the nylon ones but without the inconvenience of cleaning and upkeep. Reinforced edges. T° 70°C max. Roll in a dispenser box.

Dispenser box of 100 disposable pastry bags - Polyethylene



Code	Designation	Lcm	Kg
4346.45N		45	1
4346.55N		54	1,35

The throw-away piping bags have the same use as the nylon ones but without the inconvenience of cleaning and upkeep. Reinforced edges. They are made of transparent polypropylene. Their hygiene is perfect. They are also very practical in their dispenser box. 90 microns.

Set of 8 plastic clips TWIXIT to close pastry bags



Code	Designation	Kg
4336.00	3 different sizes : L. 13 / 10 / 5 cm	0,1

Holder for pastry bag, polypropylene



Code	Designation	Øcm	Hcm	Kg
4347.10N		19,5	23	0,12

This pastry bag holder is made of food plastic and enables one to maintain the full pastry bag straight, ready to use.

Wall rack for pastry bag and nozzles, stainless steel



Code	Designation	Wcm	Hcm	Kg
4347.20N		50	50	1,3

This wall rack is made of stainless steel. It enables one to dry and store pastry bags (upper part) and nozzles (bottom part).

Stainless steel pastry-roll core



Code	Designation	Øcm	Lcm	Th.mm	Kg
3007.15		1,5	10	0,3	0,01
3007.20		2	5	0,3	0
3007.21		2	10,5	0,3	0,01
3007.25		2,5	10	0,3	0,01

This tool lets you make puff pastry rolls which can then be filled with sweet or savory mixtures.

St. steel tube



Code	Designation	Øcm	Lcm	Kg	PU
3000.04	Champagne Cork/Mushroom, individual	4	4	0,06	5
3005.02	Cheese Roulé, individual	2,1	10	0,05	5

These stainless steel tubes are especially robust (1.5mm / 16 gauge thick) and easy to keep clean. They help you make catering products (cheese rolls, mini-soufflés, etc.).

Stainless steel horn core



Code	Designation	Øcm	Lcm	Th.mm	Kg
3006.25		2,5	9	0,3	0,01
3006.30		3	12	0,3	0,01
3006.35		3,5	14	0,3	0,02

This conical mould lets you make puff-pastry horns of plenty.

Graduated ruler, st. steel



Code	Designation	Lcm	Wcm	Th.mm	Kg
3305.65		65	6	1,5	0,45

This stainless steel metric flat rule is especially robust (1.5mm/16 gauge thick) and will not distort. What's more, it's easy to keep clean. Double graduations every centimetre (length 65cm).

Silicone brush



Code	Designation	Lcm	Wcm	Kg
4807.00N		19,5	3	0,02
4807.25N		25	3	0,04
4807.50N		25	6	0,05

Hygienic brush. Easily cleanable.

Large silicone pastry brush



Code	Designation	Lcm	Wcm	Hcm	Kg
4807.60N	fine silk	25	4	3	0,07

A wider and thicker brush: more preparation (butter, egg yolk...) is taken once and the finest silk allows a more regular brushing without traces.

Pastry brushes with wooden handle - Natural bristles



Code	Designation	Lcm	Wcm	Kg
4805.01N	Set of 2 pastry brushes l.30 mm	23	3	0,4
4805.02N	Set of 2 pastry brushes l.40 mm	24	4	0,6
4805.03	Set of 2 pastry brushes l.50 mm	25,5	5	0,8

The pastry brush is used for glazing yeast dough or for coating desserts. It can also be used to moisten the walls of a sugar saucepan.

Pastry brushes with plastic handle and ferrule - Natural bristles



Code	Designation	Lcm	Wcm	Kg
4802.30N		20	2,5	0,03
4802.40N		21	4	0,04
4802.50N		21,5	5	0,05

Brush with natural bristles. Suitable for preparations, decorations or for application of yolk.

Kitchen blowtorch



Code	Designation	Hcm	Kg
2040.00N	Delivered empty	15,7	0,17

An absolute must for caramelizing Catalan creams, flans, meringue tarts, or apple tarts, melting cheese, browning meats, peeling tomatoes, and even for paint stripping! Easy and safe to use with its automatic

piezoelectric ignition button and adjustable flame. For use with Butane gas (lighter gas). Easy-to-fill tank.

St. steel caramelizing iron



Code	Designation	Kg
3052.15	With bowlamp "Soudogaz X2000" (No smoke, no smell)	1,1
3052.16	Iron alone for X2000	0,5

The caramelizing iron is a stainless steel fitting that goes on the portable Soudogaz blowtorch and protects the mixture from the flame. If you use a naked flame on crème brûlées, Italian meringue, etc., to caramelize them, this is toxic and gives a burnt taste to the

food instead of a caramel flavour. This iron is sturdy, space-saving compared with an electric iron.





FLEXIBLE MOULDS

The De Buyer patented silicone Elastomoule moulds
are the flexible moulds chosen by the professionals.
They can be used for anything: warm, cold, frozen, sweet or savoury.

-228 -
ELASTOMOULE

-235 -
MOUL'FLEX PRO

-238 -
MOUL'FLEX



ELASTOMOULE

1 recipe card supplied with each mould :
 6 MOF and/or World Champions in Pastry
 realize their original pastry recipe
 in the De Buyer's Elastomoule moulds.
 Made in France ORIGINE FRANCE GARANTIE

ELASTOMOULE

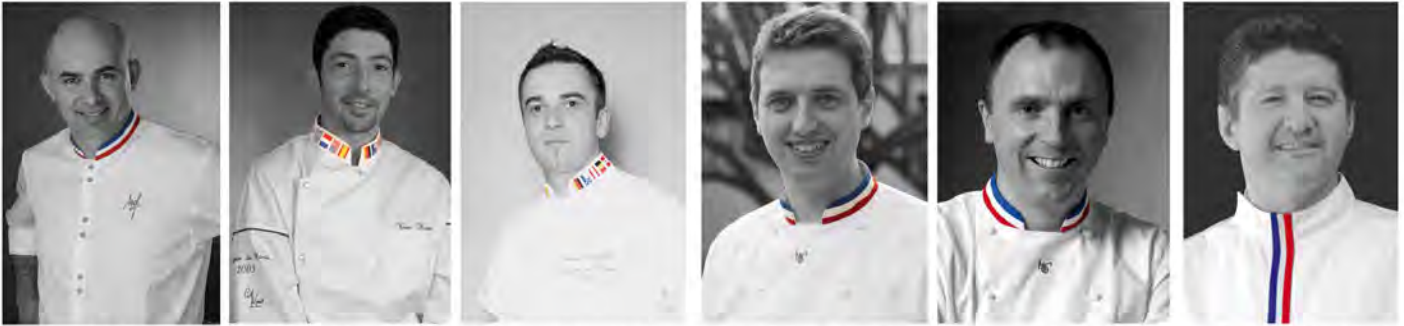

Angelo Musa
 Champion du Monde
 2003
 MOF 2007

Youri Neyers
 Champion
 du Monde
 2003

Jérôme Langillier
 Champion
 du Monde
 2009

Philippe Rigollot
 Champion du Monde
 2003
 MOF 2007

Arnaud Larher
 MOF 2007

Franck Michel
 Champion du Monde
 2006
 MOF 2004

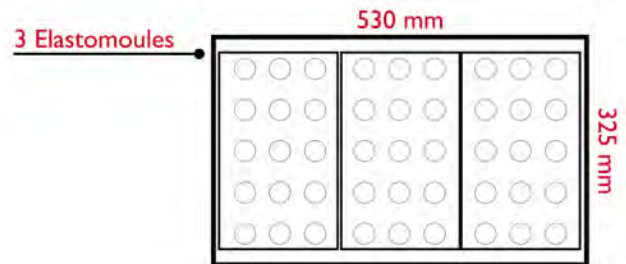
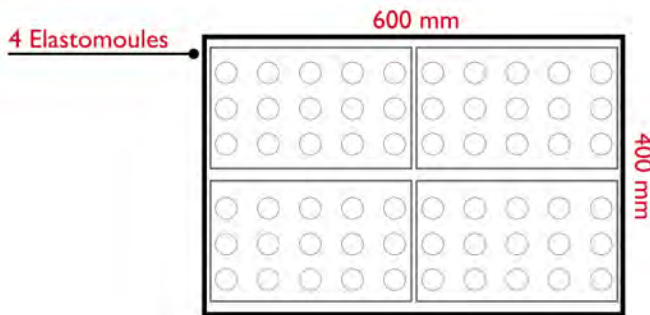

ELASTOMOULE - 8 four-part moulds "Croquant"

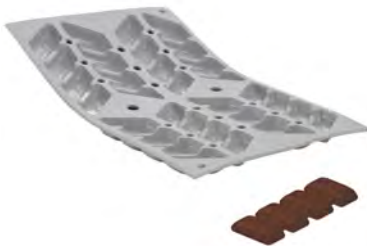

Code	Designation	Lcm	Wcm	Hcm	Kg
	creation CHRISTOPHE DEBERSEE Bakery World Champion 2008				
1874.01	Tray 29,5 x 29 cm - 8 moulds 4,85 cl While stocks last	11	4	1,6	0,25

The first mould to make preparations to share: easily divisible as precut. It is suitable for the preparation of appetizers, chocolates or 'cocktail ' pieces. Also sweet or savory preparations portions (sauces, fruit coulis...) can be frozen.



Elastomoule - 40 mini-cylinders ø 27,5 mm

Code	Designation	Øcm	Hcm	Kg
1873.01	300 x 176 mm 1,4 cl	2,75	2,5	0,26



Elastomoule - 40 mini-cubes 25 mm

Code	Designation	Lcm	Wcm	Hcm	Kg
1869.01	300 x 176 mm 1,5 cl	2,5	2,5	2,5	0,25



Elastomoule - 20 MINI Cakes

Code	Designation	Lcm	Wcm	Hcm	Kg
1868.01	Tray 300 x 176 mm 3,15 cl	5	2,7	2,7	0,26



Silicone moulds ELASTOMOULE - 48 Mini-hemispheres with flat bottom - ø 25 mm

Code	Designation	Øcm	Hcm	Kg
1866.01	300 x 176 mm 4 cl	2,5	1	0,15





Silicone moulds ELASTOMOULE - Mini-tartlet ø 50 mm - 1,9 cl

Code	Designation	Øcm	Hcm	Kg
1859.01D	30 x 20 cm - 15 cakes 1,9 cl	5	1,5	0,14
1899.01N	double stamp			0,12



Silicone foam mould. Non-stick. For cooking in the oven and freezing, from -70°C to 300°C (-90°F to 580°F). Perfect heat transmission, thereby gaining time and allowing juices to caramelize. Elastomoule mini jam tart moulds are perfect for making sweet or savory catering products.

Silicone moulds ELASTOMOULE - Mini-Muffins ø 45 / 38 mm - 3,9 cl

Code	Designation	Øcm	Lcm	Wcm	Hcm	Kg
1858.01D	30 x 20 cm - 15 cakes 3,9 cl	4,5	30	17,6	3	0,24
1858.21D	21 x 17,5 cm - 9 cakes	4,5	21	17,6	3	0,17



Silicone foam mould. Non-stick. For cooking in the oven and freezing, from -70°C to 300°C (-90°F to 580°F). The Elastomoule material transmits heat perfectly and gives a lovely golden

appearance to the top and underneath of products while giving them a succulent taste thanks to the caramelization of juices. The mould has sharp angles for a nice appearance.

Silicone moulds ELASTOMOULE - Mini-"Bordelais" fluted cake - 1,9 cl

Code	Designation	Øcm	Lcm	Wcm	Hcm	Kg
1856.01D	30 x 17,6 cm, 28 cakes - R'SYSTEM 1,9 cl	3,5	30	17,6	3,5	0,31
1856.21D	21 x 17,5 cm - 20 cakes 1,9 cl	3,5	21	17,6	3,5	0,22



The Elastomoule mini Bordelais R'SYSTEM is a BRAND NEW mould. Localized perforations between the indentations give improved

heat convection across the whole plate, resulting in perfect baking.

Silicone moulds ELASTOMOULE - Mini-financier - 1,05 cl

Code	Designation	Lcm	Wcm	Hcm	Kg
	1,05 cl				
1852.01D	30 x 20 cm - 25 cakes	4,9	2,6	1,1	0,14
1852.21D	21 x 17,6 cm - 15 cakes	4,9	2,6	3	0,1



Silicone foam mould. Non-stick. For cooking in the oven and freezing, from -70°C to 300°C (-90°F to 580°F). The Elastomoule material transmits heat perfectly and gives a lovely golden appearance to the top and underneath of products while giving

them a succulent taste thanks to the caramelization of juices. The mould has sharp angles for a nice appearance.



Silicone moulds ELASTOMOULE - Mini-tartlet ø 45 mm- 0,95 cl

Code	Designation	Øcm	Hcm	Kg
1853.01D	30 x 20 cm - 24 cakes	4,5	1,1	0,15
1853.21D	21 x 17,6 cm - 12 cakes	45	1,1	0,1
1899.01N	double stamp			0,12

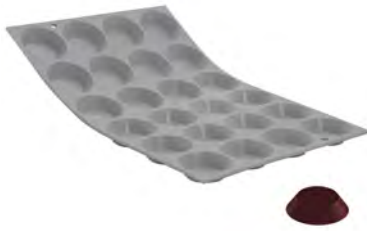

Silicone foam mold. Non-stick. For cooking in the oven and freezing, from -70°C to 300°C (-90°F to 580°F). Perfect heat transmission, thereby gaining time and allowing juices to caramelize. Elastomoule mini jam tart moulds are perfect for making sweet or savory catering products. Use the ref.1899.01N die for indenting the pastry in this model.

ELASTOMOULE CUBE

Code	Designation	Lcm	Wcm	Hcm	Kg
1836.01	cube portions - 8 cakes 11,5 cl.	5	5	5	0,34
1861.01	minicubes mould - 15 cakes 4 cl.	3,5	3,5	3,5	0,28

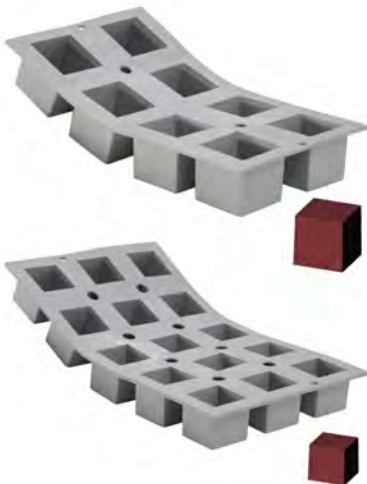

The cubic revolution is taking hold in the kitchen, bringing original creations to your plates and shapely formations to your platters. The cube portion mould makes individual preparations, and the mini-cube mould prepares pastries the perfect size to pop in your mouth. Finger food and delicacies at the same time. The Elastocube has been carefully designed to guarantee flawless shapes with straight lines and geometric angles. It is suitable for both hot and

cold use, and will successfully fulfill any and all of your demands

Silicone moulds ELASTOMOULE - Mini-Muffins 'Pomponnette' ø 46/30 mm

Code	Designation	Øcm	Lcm	Wcm	Hcm	Kg
1862.21	23,5 x 17,6 cm - 12 cakes	4,6	23,5	17,6	2,4	0,13



Silicone foam mould. Non-stick. For cooking in the oven and freezing, from -70°C to 300°C (-90°F to 580°F). The Elastomoule material transmits heat perfectly and gives a lovely golden appearance to the top and underneath of products while giving them a succulent taste thanks to the caramelization of juices. The mould has sharp angles for a nice appearance.



Silicone moulds ELASTOMOULE - Mini-madeleine - 0,64 cl

Code	Designation	Lcm	Wcm	Hcm	Kg
1851.01D	30 x 20 cm - 30 cakes	4	3	1,1	0,13
1851.21D	21 x 17,6 cm - 20 cakes	4	3	1,1	0,1

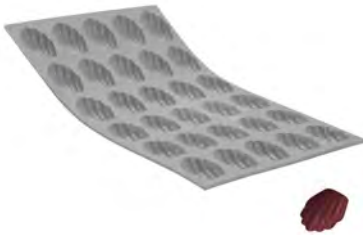

Silicone foam mould. Non-stick. For cooking in the oven and freezing, from -70°C to 300°C (-90°F to 580°F). The Elastomoule material transmits heat perfectly and gives a lovely golden

appearance to the top and underneath of mini Madeleine cakes while giving them a succulent taste thanks to the caramelization of juices that takes place in these moulds.

Silicone moulds ELASTOMOULE - Mini-hemispherical - 1,2 cl

Code	Designation	Øcm	Hcm	Kg
1850.01	29 x 19,3 cm - 24 cakes	3	1,8	0,11
1850.21	21 x 17,6 cm - 20 cakes	3	1,8	0,1



Silicone foam mould. Non-stick. For cooking in the oven and freezing, from -70°C to 300°C (-90°F to 580°F). Perfect heat transmission, thereby gaining time and allowing juices to

caramelize. The mini hemispheres are perfect for making chocolates, dainties, fruit paste sweets.

Silicone moulds Elastomoule - 8 small Brioches

Code	Designation	Øcm	Hcm	Kg
1845.01	30 x 17,6 cm - 8 cakes ø 60/31 mm 4,2 cl	6	2,8	0,16



Elastomoule - PORTIONS GEO - 10 triangles

Code	Designation	Lcm	Wcm	Hcm	Kg
1843.01	21 x 17,6 cm - 10 cakes 6,6 cl	6,6	6,6	3,5	0,28





Silicone moulds ELASTOMOULE - PORTIONS "Bordelais" fluted cake - 8,2 cl

Code	Designation	Øcm	Hcm	Kg
1834.01D	30 x 20 cm - 8 cakes 8,2 cl	5,5	5	0,3
1834.21D	21 x 17,6 cm - 6 cakes	55	5	0,17

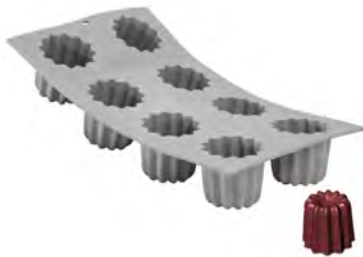

Silicone foam mould. Non-stick. For cooking in the oven and freezing, from -70°C to 300°C (-90°F to 580°F). Perfect heat transmission, thereby gaining time and allowing juices to

caramelize. The "Bordelais" Elastomoule Portions give the same cooking quality and savors as the famous copper molds used for crunchy Bordeaux Cannelé cakes.

Silicone moulds ELASTOMOULE - PORTIONS Muffins ø 74 / 54 mm - 9,5 cl

Code	Designation	Øcm	Lcm	Wcm	Hcm	Kg
1833.01D	30 x 20 cm - 6 cakes 9,5 cl	7,4	30	17,6	3	0,16
1833.21D	21 x 17,6 cm - 4 cakes	74	21	17,6	3	0,11



Silicone foam mould. Non-stick. For cooking in the oven and freezing, from -70°C to 300°C (-90°F to 580°F). The Elastomoule material transmits heat perfectly and gives a lovely golden

appearance to the top and underneath of products while giving them a succulent taste thanks to the caramelization of juices. The mould has sharp angles for a nice appearance.

ELASTOMOULE -PORTIONS Madeleine - 3 cl

Code	Designation	Lcm	Wcm	Hcm	Kg
1832.01D	30 x 20 cm - 9 cakes 3 cl	8	4,5	1,7	0,14
1832.21D	21 x 17,6 cm - 8 cakes	8	4,5	1,8	0,1

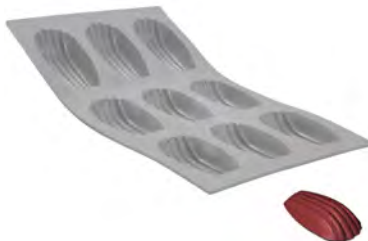

Silicone foam mould. Non-stick. For cooking in the oven and freezing, from -70°C to 300°C (-90°F to 580°F). The Elastomoule material transmits heat perfectly and gives a lovely golden

appearance to the top and underneath of Madeleine cakes while giving them a matchless taste thanks to the caramelization of juices that takes place in these moulds.

ELASTOMOULE - PORTIONS Cake - 10,5 cl

Code	Designation	Lcm	Wcm	Hcm	Kg
1831.01D	30 x 20 cm - 9 cakes 10,5 cl	9	4,8	3	0,26
1831.21D	21 x 17,5 cm - 6 cakes	9	4,8	3	0,11



Silicone foam mould. Non-stick. For cooking in the oven and freezing, from -70°C to 300°C (-90°F to 580°F). The CAKE Elastomoule is made from a material that transmits heat perfectly

and gives a lovely golden appearance to the top and underneath of cakes, fruit cakes, and breadrolls while giving them a succulent taste thanks to the caramelization of juices.

Silicone moulds ELASTOMOULE - Financier - 4,2 cl

Code	Designation	Lcm	Wcm	Hcm	Kg
1875.21	21 x 17,6 cm -6 cakes	9,5	4,4	1,2	0,1



Silicone foam mould. Non-stick. For cooking in the oven and freezing, from -70°C to 300°C (-90°F to 580°F). The Elastomoule material transmits heat perfectly and gives a lovely golden appearance to the top and underneath of products while giving them a succulent taste thanks to the caramelization of juices. The mould has sharp angles for a nice appearance.

Silicone mat ELASTOMOULE, smooth relief (10 mm high)

Code	Designation	Lcm	Wcm	Hcm	Kg
1800.55		55,5	36	1	0,3



Patterned silicone foam tray. Non-stick. For cooking in the oven and freezing, from -70°C to 300°C (-90°F to 580°F). Perfect heat transmission, thereby gaining time and allowing juices to caramelize. The plain tray is perfect for making caramels, fruit paste, etc., which are then cut up using a banjo-wire guillotine.

Aluminum double-ended moulding stamp

Code	Designation	Kg
1899.01N	double stamp	0,12



This die press is made from cast aluminium. Both ends can be used for pushing pastry mix into 45mm Elastomoule/MOUL'FLEX, or 50mm Elastomoule tart moulds. The die's ergonomic shape provides a perfect hand grip.

Silicone nonstick supple professional moulds

Moul'flex Pro



- Foodgrade PLATINUM silicone without peroxide guaranteed. For intensive use
- Professional dimensions 400 x 600 mm or GN 1/1.
- For oven cooking and freezing from -40°C/-40°F to +300°C/580°F
- Reduction in cooking time thanks to the R'System® perforations. Perforations localized between the various imprints of the plate for a better heat or cold convection and to obtain: Patented system

Silicone moulds MOUL'FLEX PRO - 24 oblong moulds



Code	Designation	Lcm	Wcm	Hcm	Kg
1722.60	Tray 600 x 400 mm - 24 cakes 7,8 cl	14	3	2,1	0,64



To make individual original cream cakes or tartlets, easy to handle. Shape adapted to the 'Eclair' cake special trays for confectioners.

To be combined with:
 - the oblong stainless steel pastry rings 3037.14 and 3099.40 which are used as cutter for preparing biscuit or tartlet bottoms
 - the pusher 3006.04

Silicone moulds MOUL'FLEX PRO - portions CUBES 45 mm

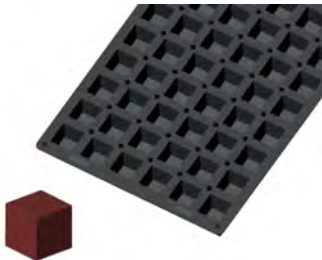

Code	Designation	Lcm	Wcm	Hcm	Kg
1715.60	Tray 600 x 400 mm - 54 cakes 9,1 cl	4,5	4,5	4,5	1,4
	While stocks last				

Silicone moulds MOUL'FLEX PRO - Mini-hemispherical molds ø 35 mm

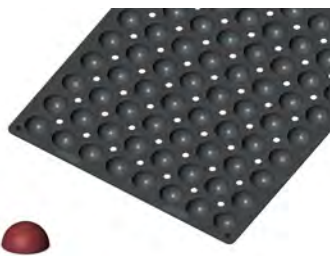

Code	Designation	Øcm	Liters.	Kg
1718.60		3,5	1,05	0,6
	1,1 cl			

Silicone moulds MOUL'FLEX PRO - Hemispherical molds



Code	Designation	Øcm	Hcm	Kg
1704.60	Tray 600 x 400 mm - 28 cakes 8,4 cl	7	3,5	0,67
1704.53	Tray gastro GN 1/1 - 18 cakes	7	3,5	0,4

Silicone moulds - MOUL'FLEX PRO - mini cakes

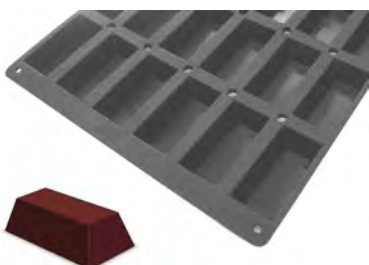

Code	Designation	Lcm	Wcm	Hcm	Kg
1701.60	Tray 600 x 400 - 30 cakes 10,5 cl	9,7	4,8	3	0,75
1701.53	Tray Gastro GN 1/1 - 20 cakes	9,7	4,8	3	0,5

Silicone moulds MOUL'FLEX PRO - "florentins"

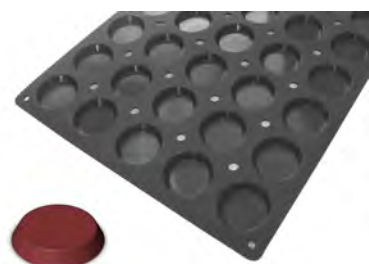

Code	Designation	Øcm	Hcm	Kg
1702.60	Tray 600 x 400 mm - 40 cakes 2,3 cl	5,6	1	0,57

Silicone moulds MOUL'FLEX PRO - portions "Madeleine"

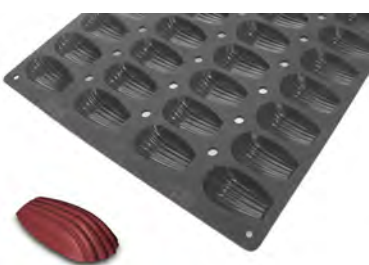

Code	Designation	Lcm	Wcm	Hcm	Kg
1707.60	Tray 600 x 400 mm - 44 cakes 3 cl	7,57	4,2	1,8	0,68

Silicone moulds MOUL'FLEX PRO - portions muffins

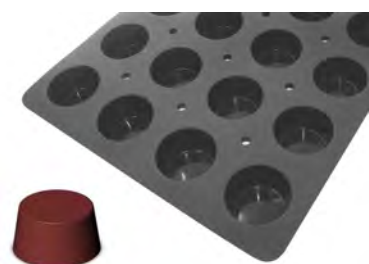

Code	Designation	Øcm	Hcm	Kg
1710.60	Tray 600 x 400 mm - 24 cakes 12,2 cl	6,8	3,5	0,74
1710.53	Tray gastro GN 1/1 - 24 cakes	6,8	3,5	0,54

Silicone moulds MOUL'FLEX PRO - portions "Bordelais" fluted cakes

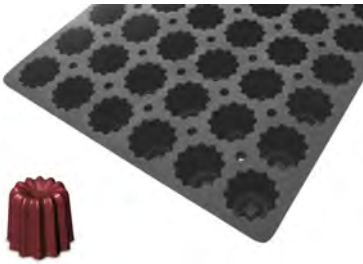

Code	Designation	Øcm	Hcm	Kg
1708.60	Tray 600 x 400 mm - 54 cakes 8,2 cl	5,5	4,7	1

Silicone moulds MOUL'FLEX PRO - mini-tartlets

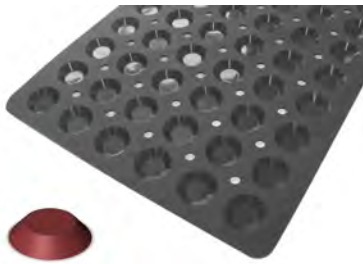

Code	Designation	Øcm	Hcm	Kg
1711.60	Tray 600 x 400 mm - 60 cakes 0,95 cl	4,1	0,8	0,58
1711.53	Tray gastro GN 1/1 - 40 cakes While stocks last	5	1,5	0,41

Silicone moulds MOUL'FLEX PRO - mini muffins

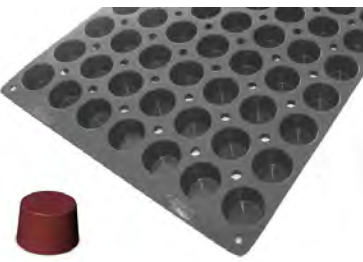

Code	Designation	Øcm	Hcm	Kg
1703.60	Tray 600 x 400 mm - 70 cakes 3,9 cl	4,2	2,8	0,84

Transparent silicone moulds - MOUL'FLEX PRO KRYSTAL- Long mould (yug log)



Code	Designation	Lcm	Wcm	Hcm	Liters.	Kg
1712.60	Tray 600 x 400 mm - 4 ROUND long cakes 219 cl	50	8	6,2	8,7	0,97
	While stocks last					

These non-stick, silicone Yule log moulds offer the following advantages over stainless steel and disposable moulds: - Easy to turn out straight from the freezer, no need to apply film. - Fully sealed so can be coated with liquid mousses left to set in cold storage. - Hygienic - machine washable and, most importantly, non-welded. - Easy to handle and store. Can be used in the catering trade for fish, vegetable and foie gras pâtés. Also suitable for baking buns.



FLEXIBLE NONSTICK MOULDS
 Foodgrade PLATINUM SILICONE
 guaranteed without peroxyde
 -40° to + 280°C (-40° / 530°F)

*Ideal for SWEET and SAVORY HOT,
 COOL or FROZEN PREPARATIONS*

MOUL'FLEX - 7 rectangular "Financier" cakes

Code	Designation	Lcm	Wcm	Hcm	Kg
1976.03	Black tray 295 x 173 mm	9,5	4,5	1,2	0,09



MOUL'FLEX - 12 moulds "Dariole" ø 40 / 35 mm - 35 mm high

Code	Designation	Øcm	Hcm	Kg
1960.01	Black tray 17,5 x 27,5 cm 4 cl	4	3,5	0,15
	While stocks last			



MOUL'FLEX - 25 moulds Mini-Financiers

Code	Designation	Lcm	Wcm	Kg
1976.02	Tray 17,5x30 cm 1,05 cl	4,9	2,6	0,15



MOUL'FLEX- Silicone moulds - 12 round fluted moulds "TRADITION 1900"

Code	Designation	Øcm	Hcm	Kg
1967.01	Black tray 17,5 x 27,5 cm 3,5 cl	4,1	4,3	0,16
	While stocks last			



MOUL'FLEX- Silicone moulds - Mini-"Bordelais" fluted cakes

Code	Designation	Øcm	Hcm	Kg
1977.01	BLACK tray 17,5 x 30 cm - 28 "Bordelais" cake 1,9 cl	3,5	3,5	0,21



MOUL'FLEX- Silicone moulds - 8 Bordelais fluted cakes

Code	Designation	Øcm	Hcm	Kg
1968.01	tray 17,5x30 cm 8,2 cl	5,5	5	0,16

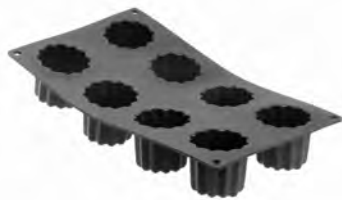

MOUL'FLEX - 8 big cones

Code	Designation	Øcm	Hcm	Kg
1997.01	Black tray 17,5 x 30 cm 9,2 cl While stocks last	5,1	5,9	0,13



MOUL'FLEX- Silicone moulds - CUBES 45 mm

Code	Designation	Lcm	Wcm	Hcm	Kg
1996.01	BLACK 17,5 x 30 cm - 8 cubes 9,1 cl	4,5	4,5	4,5	0,19



MOUL'FLEX- 15 Silicone moulds - Hemispherical ø 4 cm

Code	Designation	Øcm	Hcm	Kg
1961.02	tray 17,5x30 cm 2 cl	4	2	0,1



MOUL'FLEX- Silicone moulds - Hemispherical ø 7 cm

Code	Designation	Øcm	Hcm	Kg
1961.01	BLACK 17,5x30 cm - 6 hemispherical moulds 8,9 cl	7	3,4	0,1



The MOUL'FLEX range of flexible silicone moulds offers you a wide choice of baking plates and large individual moulds for making sweet, savory, hot, cold, and frozen preparations.

MOUL'FLEX- Silicone moulds - 6 Muffins

Code	Designation	Øcm	Hcm	Kg
1962.01	tray 17,5x30cm 9,7 cl	7,2	3	0,11



MOUL'FLEX is as good for baking as it is for freezing and turns out to be ideal for bain-marie cooking. The silicone is non-stick: there's no need to grease the moulds, and turning out and cleaning are extremely easy.



MOUL'FLEX- Silicone moulds - Small fluted brioches

Code	Designation	Øcm	Hcm	Kg
1964.01	BLACK tray 17,5 x 30 cm - 6 small brioches 9,5 cl	8	3,5	0,11



Before first use: - Wash the MOUL'FLEX in soapy water or in the dishwasher - Grease the mould the first time you use it with a little oil or melted butter. For subsequent use, you don't need to grease the mould any more.

MOUL'FLEX- Silicone moulds - Mini round tartlets ø 5 cm

Code	Designation	Øcm	Hcm	Kg
1975.01	BLACK tray 17,5 x 30 cm - 15 round tartlets 1,9 cl	5	1,5	0,1



MOUL'FLEX- Silicone moulds - 6 round tartlets ø 8,5 cm

Code	Designation	Øcm	Hcm	Kg
1978.01	Tray 20x30 cm 7,3 cl	8,5	1,5	0,1



MOUL'FLEX- Silicone moulds - Madeleines

Code	Designation	Lcm	Wcm	Hcm	Kg
1966.01	BLACK tray 17,5 x 30 cm - 9 madeleines 3 cl	7,5	4,5	1,8	0,1



- For use in a heat-circulating oven, place the grille at mid-height in the oven. - For use in a traditional oven, place it near the bottom of the oven instead.

MOUL'FLEX - Silicone moulds - Mini-Madeleine

Code	Designation	Lcm	Wcm	Hcm	Kg
1994.01	Black tray - 17,5 x 30 cm - 30 cakes 0,63 cl	4	3	1,1	0,09



MOUL'FLEX- Silicone moulds - Savarin

Code	Designation	Øcm	Hcm	Kg
1963.01	tray 17,5 x 30 cm - 6 Savarin moulds 7 cl	7,2	2,3	0,14



For making everything from attractive rum babas and jelly crowns to fish pâté.

MOUL'FLEX - "Pomponnette" rounded moulds

Code	Designation	Øcm	Hcm	Kg
1999.01	8 round moulds "Pomponnette"- 0,4 cl Black tray 17,5 x 30 cm While stocks last	5,7	1,5	0,09
1999.02	24 small round moulds "Pomponnette"- 0,18 cl Black tray 17,5 x 30 cm While stocks last	3	1,5	0,1



MOUL'FLEX- Silicone moulds - Heart

Code	Designation	Lcm	Wcm	Hcm	Kg
1970.01	BLACK tray 17,5 x 30 cm - 8 "Heart" moulds 7,8 cl While stocks last	6,5	6	3	0,13



MOUL'FLEX- Silicone moulds - Rectangular mould Cake



Code	Designation	Lcm	Wcm	Hcm	Kg
1976.01	BLACK tray 17,5 x 30 cm - 9 Cake moulds 9 cl	9	4,8	3	0,19

MOUL'FLEX- 8 silicone moulds - Oval



Code	Designation	Lcm	Wcm	Hcm	Kg
1971.01	Tray 17,5x30 cm 9,7 cl While stocks last	6,5	4,1	3,4	0,16

Silicone moulds - Mini Kougloff



Code	Designation	Øcm	Hcm	Th.mm	Kg
1979.01	BLACK tray 17x30 cm - 6 Mini Kougloff 9 cl While stocks last	7	3,6	0,1	0,14

MOUL'FLEX - Silicone mould "Heart"



Code	Designation	Lcm	Wcm	Hcm	Liters.	Kg
1981.22	BLACK While stocks last	21,8	20,8	3,8	1,2	0,1

The heart mould lets you make cakes, ice-cream, or other desserts with an original shape that's perfect for birthdays, Mother's Day, and of course, Saint Valentine's day.

MOUL'FLEX - Rectangular Silicone mould 28,5 x 25 cm



Code	Designation	Lcm	Wcm	Hcm	Liters.	Kg
1982.28	BLACK While stocks last	28,5	25	4	2,3	0,21

This rectangular mould can be used for making cakes, gratins, sponge cakes, etc.

MOUL'FLEX - Silicone mould - Rectangular mould CAKE

Code	Designation	Lcm	Wcm	Hcm	Liters.	Kg
1984.24	BLACK	24	10,5	6,5	1,4	0,16



This mould can be used for making sweet or savory cakes, pâtés, etc.

MOUL'FLEX - Round pie pan

Code	Designation	Øcm	Hcm	Liters.	Kg
	BLACK MOUL'FLEX				
1990.20		20	4	1,25	0,14
	While stocks last				
1990.24		24	4,2	1,9	0,17
1990.26		26	4,4	2,35	0,2
	While stocks last				



MOUL FLEX - Tower

Code	Designation	Lcm	Wcm	Hcm	Kg
1989.00		26,4	16	5	0,16



MOUL'FLEX Single

Code	Designation	Øcm	Hcm	Kg
1980.10	MOUL'FLEX Single ø 10 cm - 15 cl	10	2	0,02
	While stocks last			



MOUL'FLEX is as good for baking as it is for freezing and turns out to be ideal for bain-marie cooking. The silicone is non-stick: there's no need to grease the moulds, and turning out and cleaning are extremely easy.

MOUL'FLEX - Set of 6 silicone round muffin moulds "CUP CAKE"

Code	Designation	Kg
1985.05	ø 5 cm	0,03
	While stocks last	



MOUL FLEX quality - Pure platinum silicone - peroxyde free. For freezing and oven cooking (traditional oven and microwaves). Perfect for muffins, savory or sweet cakes, pannacottas, chocolate cakes, custards,... Packed in a PVC transparent box.







CATERING

For decades, De Buyer has been a regular supplier to larger-scale operations, equipping them with isothermal containers and storage cupboards. The company also supports - and perhaps comforts - the French army by providing canteens and canteen cups for missions.

- 246 -
Isothermal containers

- 247 -
Utensils for army

- 249 -
Isothermal cupboards



Isothermal container with standard lid



Code	Designation	Øcm	Hcm	Liters.	Kg
	For food or beverage. Patented Bi-material construction of body and lid: st. steel inside, polyethylene outside St. steel inserts sold separately on choice				
	CAPACITY :				
3760.16	Capacity 16 L with inserts or 23 L without inserts	42	42	16	9,6
3760.25	Capacity 25 L with inserts or 33 L without inserts	42	56	25	11,4

These insulated containers let you transport and stock food or drinks, keeping them hot or cold, in full safety and compliance with current hygiene standards. The containers' stainless steel interiors enable spotless cleaning. These containers are available in two shades: Sandy or NATO green. The containers are stackable.

Isothermal container with liquid lid



Code	Designation	Øcm	Hcm	Liters.	Kg
	For food or beverage. Patented Bi-material construction of body and lid st. steel inside, polyethylene outside St. steel inserts sold separately on choice				
	CAPACITY :				
3762.16	Capacity of 16 L with inserts or 23 L without inserts	42	48	16	10,8
3762.25	Capacity of 25 L with inserts or 33 L without inserts	42	62	25	12,4

The insulated containers with a pourer lid let you transport, stock, and distribute hot or cold drinks in full safety and compliance with current hygiene standards. The containers' stainless steel interiors enable spotless cleaning. These containers are available in two shades: Sandy or NATO green. The containers are stackable.

Body alone, bi-material, cylindrical, no lid



Code	Designation	Øcm	Hcm	Liters.	Kg
	or 23 L without inserts				
3769.25	Capacity : 25L with inners ctrs or 33 L without inserts	42	52	25	9,3

These insulated containers let you transport and stock food or drinks, keeping them hot or cold, in full safety. The interior is stainless steel. These containers are available in two shades: Sandy or NATO green. Thanks to the interchangeability of the lids, you can transform a food container with a standard lid into a drinks container by fitting a pourer lid.

Cylindrical lids, bi-material st. steel/polyethylene



Code	Designation	Øcm	Hcm	Kg
3770.00	Round standard lid alone, bi material st. steel	42	6	2,1
3771.00	Round liquid lid alone, bi-material	42	12	2,8
SPARE PARTS:				
3831.00N	Rubber joint for round lids 3770/3771			0,33
3771.95	Tap for 3771.00 with st.steel nut and joint			0,1
3771.93	St.steel nut and joint			0,07
3771.94	Air inlet with joint, depression pipette and nut for 3771.00			0,02

Thanks to the interchangeability of the lids, you can transform a food container with a standard lid into a drinks container by fitting a pourer lid.

Round stainless steel inserts with 2 handles, no lid



Code	Designation	Øcm	Hcm	Liters.	Th.mm	Kg
3800.04		28	6,5	4	0,8	0,82
3800.06		28	10	6	0,8	0,95
3800.08		28	13,7	8	0,8	1,15
3800.12		28	20,5	12	0,8	1,48
3800.16		28	27,5	16	0,8	2

Thanks to the interchangeability of the lids, you can transform a food container with a standard lid into a drinks container by fitting a pourer lid.

Round st. steel flat lid



Code	Designation	Øcm	Th.mm	Kg
3820.00	For lower insert	28	0,8	0,5
3821.00	For upper insert	28	0,8	0,5

The lids fit over the inner cans to prevent splashes. They have a fold-away lifting handle. Lids for use with inner cans are flat to allow stacking. The lid of the top can in the stack is domed to fit snugly into the lid of the insulated container, thus ensuring top-down pressure on all the inserts and guaranteeing perfect stability and sealing.

Mug with 2 folding handles



Code	Designation	Lcm	Wcm	Hcm	Liters.	Th.mm	Kg	PU
3979.00	St. steel mug	13,6	9	9,5	0,7	0,7	0,21	10

The mug is a piece of camp equipment meant for a soldier's use. This stainless steel model is especially robust and hygienic and is easy to keep clean. The two handles fold away to take up less room.

Stainless steel cup for "self" dish 3222.06



Code	Designation	Øcm	Hcm	Liters.	Th.mm	Kg	PU
3570.00		8	8	0,32	0,8	0,14	6

This utensil is a piece of camp equipment meant for a soldier's use. Made from stainless steel, it is especially robust and hygienic and easy to keep clean. It fits onto the stainless steel self-service tray ref. 3222.06

Plastic water bottle (Army model), fitting into the mug



Code	Designation	Lcm	Wcm	Hcm	Liters.	Kg	PU
4959.00	Green NATO	13,2	8,1	22,8	1,3	0,14	20

Set of water bottle + mug + cover



Code	Designation	Kg	PU
4949.01		0,6	20

Stainless mess tin with 2 compartments fitting together - Army model



Code	Designation	Lcm	Wcm	Kg	PU
3960.00	1 nonstick pan and 1 all st/steel	20	15	0,52	20

Self-service dish - Depth 24 mm



Code	Designation	Lcm	Wcm	Hcm	Liters.	Th.mm	Kg
3222.06	6 compartments	43	33	2,3	0,25	0,8	0,98

Self service dish, St. steel 18/10



Code	Designation	Lcm	Wcm	Hcm	Th.mm	Kg
3221.06	With 6 compartments	40	30	1,6	0,8	0,7

This stainless steel self-service tray is especially robust and hygienic and is easy to keep clean. It has 6 cavities and accepts a rectangular stainless steel starters dish (no photograph provided).

Isothermal mobile storage cupboard 200 L.



Code	Designation	Lcm	Wcm	Hcm	Liters.	Th.mm	Kg	PU
3870.50	Mobile cupboard alone -200 L.	81,8	56,8	110	200		42,4	1
Internal dimensions : 62x43,5x83,5 cm								
ST.STEEL FRAME :								
3879.52	Halfway up for tray 60x40 cm and GN -5 levels						8,9	1
3879.51	For GN and 60x40 cm - 10 levels 10 levels at 7 cm spacings							1
ACCESSORIES								
3878.00N	Eutectic plate - Positive Cold - 3 °C						4,55	1
3878.01N	Eutectic plate - Negative cold - 21 °C						4,55	1
3321.53	GN 1/1	53	32,5	1		1	1,34	5
3876.05	St. steel fastener (to superimpose)							1

The double-walled structure is a single-piece polythene rotation molding for exceptional toughness. Injected high density polyurethane foam cupboard, ensuring all preparations are kept at

a perfect temperature. Lets you stock or transport products and preparations in a utility vehicle with the help of eutectic plates. The cupboards are easy to handle thanks to their handles.

Isothermal mobile storage cupboard 120 L.



Code	Designation	Lcm	Wcm	Hcm	Liters.	Kg
3871.00	Isothermal mobile storage cupboard 120 L.	81,8	56,8	67	120	27
Internal dimensions : 62x43,5x44 cm						
ST.STEEL FRAME :						
3869.00	For tray 60x40 cm and GN 6 levels at 7 cm spacings					
ACCESSORIES						
3878.00N	Eutectic plate - Positive Cold - 3 °C					4,55
3878.01N	Eutectic plate - Negative cold - 21 °C					4,55
3876.05	St. steel fastener (to superimpose)					

The 120 litre (25 gallon) cupboard has the same advantages as the 200 litre (40 gallon) model. The cupboard's internal arrangement is ingenious: it lets you use the cupboard 3 different ways (without rack, in 60 x 40cm/24" x 16" format, and in GN 1/1 format).

Other accessories for isothermal mobile storage cupboard



Code	Designation	Øcm	Kg
3886.00N	Set of 4 wheels - steel	10	4,2
3886.20N	set of 4 wheels - stainless steel	10	4,2
3886.40N	set of 4 wheels - stainless steel	12,5	4,5
Label-holder			
3875.01	For 120 & 200 L.		

The cupboard can be fitted with pivoting rubber wheels with noiseless tires; the two front wheels come with locking brakes. Wheels are available in 100 or 125mm (4" or 5") diameter, with steel or stainless treads. The wheels are ordered separately.

Displays



Display **MINERAL B ELEMENT**
REF. 5000.08
64 x 64 cm
Delivered with video and leaflets



Triangular display
for silicone moulds
REF. 1900.01
Height : 180 x 60 cm



Grid large display REF. 5000.00
255 cm high - 130 cm width - 60 cm deep.
Weight : 68 kg empty - Possible load : 500 kg.
Standard hooks : 27 cm long, ø 8 mm



'Perroquet' display
REF. 5000.60
Ht 180 cm - ø 50 cm
8 standard hooks

Brand recall

Consult us to receive the list of the selling tools at your disposal



KAKEMONOS
Fabric Dim. 90 x 40 cm
one-side printed
supplied with suspension wire
Ref : 10.1001 KAKEMONO Cooking
Ref : 10.1002 KAKEMONO Pastry



Brand recall 'de Buyer'
21x 6,5 x3 cm
Ref : 10.0006



Counter display
Pastry forms
REF : 3900.00
Dim.: 385 x 350 x Ht 504 cm

LOGO DE BUYER CHANGE



We propose you to update your displays with the new logo de Buyer; the stickers and adhesives are available under the following codes :

code	description of the logo per display	Number per display
QPR50.000	adhesive band for grid display 5000.00	1 ex
QPER10.600	Logo on PVC 13x11 cm on Eiffel Tower 5000.09/13	2 ex
1900.97	Triangular cardboard head on column 1900.01	1 ex
QPR14.002	adhesive logo for display 'Boutique' 5000.14	2 ex



Panel brand 'de Buyer'
dim. 600 x 200 mm
Ref : QPR10.700
Indoor use

Consult us for the composition of displays and the conditions to have a display at disposal

Displays

MODULAR DISPLAY UNIT

Perfect either wall-mounted or in a central position of the sales location.

Different modules are available based on the ranges that need to be displayed : consult us to define the composition of your display unit.

TWO-SIDED : both sides are visible, and it is possible to hang it on the panel facing either way.

Standard dim.(without both optional shelves) :

L. 1156 mm x 584 mm Ht 2092 cm



Possibility of having a lower version of the display unit
L. 1156 mm x 584 mm
Ht 1482 mm



VERSION A



VERSION B



VERSION C



VERSION D



VERSION E

EXAMPLES OF LAYOUT IN STORE :



4 displays wavelike

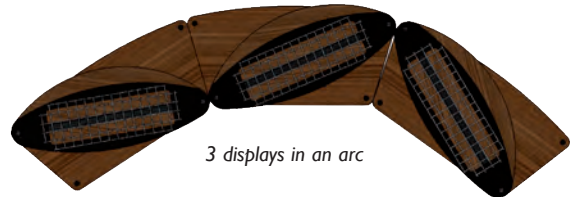

3 displays in an arc

DISPLAY UNIT 'TOWER'

for a lively boutique with an original, eye-catching display.

Emphasize the value of 'Made in France' !

the TOWER display is available in 4-sided or 6-sided versions, with removable tables and hooks and can be used to display any choice of range:

• FRENCH COLLECTION • PRIMA MATERA • AFFINITY • ELASTOMOULE • MINERAL B ELEMENT • B BOIS



6-SIDE DISPLAY TOWER 5000.13
ø 100 cm Ht 200 cm



4-SIDE DISPLAY TOWER 5000.09
60 x 60 cm Ht 200 cm - Different compositions available. Option: video screen 5000.96



Consult us for the composition of displays and the conditions to have a display at disposal

ALPHABETICAL INDEX

A		
Army mug	247	
B		
Bag (pastry bag)	220, 221	
Bag holder	222	
Bain-marie	60	
Bain-marie cooker	204	
Bakery thermometer	158	
Baking paper	170	
Baking tray	166, 167, 168	
Basting spoon	143, 144, 145	
Blade (for baker)	199	
Blini pan	12, 13, 21, 37, 75	
Bottle	203	
Bottle (army model)	248	
Bowl	130	
Brush	224	
Bucket	139	
Burner	24	
Butcher hook «S»	145	
C		
Cake spatula	145	
Candy Thermometer	158, 206	
Caramelizing iron	225	
Charlotte mould	177, 196	
Chestnut fry-pan	24, 25	
Chinese strainer	131, 132	
Chocolate fork	204	
Chocolate levelling frame	204	
Cleaner for metal	81, 162	
Colander	131	
Comb for decorating pastry	201	
Crepe pan, steel	8, 12, 16, 18, 22	
Crepe pan, nonstick	33, 37	
Cutter vegetable	107	
Cutter	197, 198, 199	
Cutting board	162	
D		
Dariole mould	191	
Deep fryer	25	
Dish	138	
Dough scraper	200	
Dough wheel	199, 200	
Dredger	138	
E-F		
Egg dish	79	
Elastomoule	228-234	
Filter for funnel	138	
Fish frypan	34, 36, 37, 47	
Fish kettle	59	
Flour scoop	148	
Frame for biscuit/cream	201, 202	
Frypan	8, 15, 31	
Frypan, steel	8-25	
Frypan, nonstick	28, 29, 31-39	
Frypan, st/steel	45, 47, 48, 49, 51, 52 55, 56	
Frypan, copper	67, 71, 72, 75, 76, 78	
Frypan «Triblinis»	13, 19	
Funnel	135, 138	
G		
Gel alcohol	162	
Genoise cutter	153	
Génoise frame (w/out bottom)	202	
Girolle	204	
Gloves	25, 30, 155, 163	
Grate	168, 169, 173	
Greaseproof paper	205	
Grip for dish	146	
H		
Hanging bar	146	
I-J		
Ice-cream scoop	148	
Isothermal container	246, 247	
Isothermal storage cupboard	249	
Jam pan, copper	81	
K		
Knife	123, 124, 125, 126	
L		
Ladle	143, 144, 145	
LE TUBE	136, 137	
Lid, copper	74, 76, 80, 247	
Lid, glass	10, 29, 53, 55	
Lid, st/steel	46, 50, 55, 58	
Lobster fork	155	
Long rolled cake mold	194, 195, 196	
M		
Mandoline slicer	108-117	
Meat fork	145	
Mess tin 3 compart., alu	248	
Mill	138	
Mini saucepan	48, 81	
Mould for «Charlotte»	177, 196	
Mould for pie	173, 175, 176	
Mould, hemispherical	191	
Mould, steel	175, 177, 178, 179,	
Mould, st/steel	191-196, 223	
Mould Canelés	81, 191	
MOUL'FLEX	238-243	
MOUL'FLEX	235-237,	

N			
Nozzles, various	207-219	Skewer	148
Nutmeg mill	92, 100	Skimmer	143, 144, 146
O		Slicer (vegetable)	108-117
Omelette turner	148	Smoker oven	61
Oval pan	79	Soup bowl	247
Oven peel	157	Spatula	37, 140- 145, 151-153
Oyster knife	155	Spices mill	84-103
P		Stand for wok	59
Paper (oven cooking)	205	Steamcooker	47, 54, 58, 61, 69
Pasta-cooker	59	Stewpan, nonstick	29
Pastry bag , disposable	221	Stewpan, st/steel	46, 48, 50, 51, 53, 57
Pastry brush	224	Stewpan, copper	69, 71, 73, 77, 79
		Stewpan, oval	47, 75
Pepper/salt mill	84-103	Stockpot	58, 68, 74, 77
Piston funnel	134, 135	Strainer	132
Pizza cutting wheel	156	String	163
Pizza oven peel	157	Sugar pomp	206
Plancha	13, 20, 30	Sugar saucepan	206
Plastic scraper	200	Sweet maker	205
Pusher	131, 233, 234	T	
R		Tart mold	156, 174, 175, 176, 178
Rack for cutting boards	162	Tart ring	180, 181, 182, 183, 184
Rack for mobile	249	Thermometer	159, 160, 161
Raplette, sliding & egalizing	203	Timer	161
Relief sheet	195	Tinned wire basket	25
Ribbon	190, 205	Tomato-slicer	119
Ring for pastry	184-189	Tube	223
Roasting pan	13, 38, 47, 59, 75	Tray	167, 168, 175, 179
Rolling pin	199	Triangular spatula	153
Round-edge tray	172	Trivet	23
Rubber joint	247	Tweezer	141, 146, 147
Ruler, graduated	223	W	
S		Whisk	150
Salt shaker	87, 102	Wok, steel	11, 19
Saucepan, nonstick	28	Wok, nonstick	30, 38
Saucepan, st/steel	44, 49, 51, 52, 54, 56	Wok, stainless steel	45, 59
Saucepan, copper	66, 70, 72, 76, 78	Wok, copper	69, 73, 80
Sauté-pan, steel	8, 10, 16	Wok stand	59
Sauté-pan, nonstick	29, 30, 31, 38	Y	
Sauté-pan, st/steel	44, 45, 46, 52, 55, 57	Yule log mould	194, 195
Sauté-pan, copper	66, 67, 68, 70 71, 73, 76, 78, 79		
Sawdust	61		
Scales	158		
Scharpener	127		
Scissors	154		
Self-service dish	248		
Sieve	132		
Silicone mat	170, 171		
Silicone moulds	228-243		
Sirup density meter	158		

All texts, information, characteristics and photographs in this catalogue are for information only and are not warranted. We disclaim liability in event of inaccuracy thereof. We reserve the right to make any changes therein without prior notice.

Credits photos : Jérôme Baudoin - Eric Marin - Agence Pernet - Lézards'Création - de Buyer Industries. Cyril Zesker.

Thanks to Atelier TB, Bragard, Febvay France, Garnier-Thiebaut, REVOL.

NUMERICAL INDEX

Code	Page	Code	Page	Code	Page	Code	Page	Code	Page	Code	Page	Code	Page	Code	Page
0236	169	1861	231	2018	107	3069	187, 189	3222	248	3412	52	3753	49	4151	207
0237	173	1862	234	2040	225	3070	189	3232	131	3427	53	3754	50	4152	208
042002	190	1866	229	2111	212	3076	187	3240	131	3429	29,53,177	3760	246	4153	208
042003	190	1868	229	2112	212, 213	3077	187, 189	3242	132	3430	51	3762	246	4155	208
042004	190	1869	229	2113	214	3079	189	3250	130	3432	51	3769	246	4156	207
042005	190	1873	229	2114	218, 219	3081	194	3271	148	3433	51	3770	247	4165	209
042010	190	1874	228	2115	214	3085	204	3274	139	3437	60,204	3771	247	4166	209
042011	190	1875	231	2116	216	3091	184	3276	139	3441	61	3800	247	4168	209
042016	190	1899	230, 231,234	2117	213	3093	184	3280	138	3449	59	3820	247	4180	210
042024	190	1960	238	2118	214	3094	189	3290	157	3459	55	3821	247	4181	210
042026	190	1961	239, 240	2119	215	3095	191	3293	157	3491	54	3831	247	4182	210
042030	205	1962	240	2120	216	3096	189	3294	148,157	3493	55	3869	249	4183	210
042031	205	1963	241	2125	218	3098	180,181	3300	200	3495	55	3870	249	4200	81, 162
042032	205	1964	240	2126	215	3099	180-183	3301	200	3496	54	3871	249	4230	152
044080N	203	1966	241	2128	215		188	3302	200	3500	205	3875	249	4231	152
044085N	203	1967	238	2129	215	3101	189	3305	223	3501	56	3876	249	4232	153
076100	205	1968	239	2130	217	3103	189	3312	198	3502	57	3878	249	4233	153
0816	24	1970	241	2140	145	3106	189	3318	181,182,	3503	57	3879	249	4234	153
0820	23	1971	242	2601	146	3111	59		184,188	3504	56	3886	249	4235	153
1701	236	1975	240	2604	151	3121	59	3320	168	3505	57	3905	184,188	4236	153
1702	236	1976	238, 242	2610	151	3122	19,59	3321	168, 249	3506	58	3906	185,188	4237	147
1703	237	1977	239	2611	151	3125	196	3323	199	3507	58	3912	186	4238	147
1704	236	1978	240	2612	118	3130	144	3324	199	3509	58	3930	131	4239	147
1707	236	1979	242	2701	142	3133	191	3329	11, 30,	3565	139	3937	185,189	4270	123
1708	237	1980	243	3000	223	3134	145		45, 69, 73	3570	247	3938	189	4271	123
1710	236	1981	242	3002	203	3135	145	3330	168	3675	47,58,69	3939	184,189	4272	123
1711	237	1982	242	3003	201	3136	145,156	3339	146	3706	44, 48	3940	185	4275	123
1712	237	1984	243	3005	223	3138	189	3350	131	3708	47, 75	3941	188	4280	125
1715	235	1985	243	3006	180-190	3139	189	3351	131	3709	46,67,74	3942	188	4281	124, 125
1718	235	1988	61	3007	223	3141	144	3352	131,132	3718	45	3943	188	4282	125
1722	235	1989	243	3010	145	3142	144	3353	135	3719	47	3960	248	4283	126
1800	234	1990	243	3011	146	3143	144	3354	131,134	3724	45,48	3979	247	4284	126
1831	233	1994	241	3013	186,202	3144	144	3356	135,138	3725	47	3982	143	4285	125, 126
1832	233	1996	239	3015	201	3150	144	3357	138	3726	47	3983	143	4286	126
1833	233	1997	239	3017	201	3170	145	3358	136,137	3727	47	3984	143	4287	125
1834	233	1999	241	3018	202	3201	172	3360	168	3730	44	3985	143	4290	127
1836	231	2000	113	3021	143	3202	194	3361	168	3736	45	3989	185	4291	127
1843	232	2004	138	3027	187, 189	3203	193	3366	168	3740	48	4021	139	4300	197
1845	232	2005	119	3030	182	3204	195	3371	130	3741	46	40466	204	4301	197
1850	232	2007	138	3031	182	3205	195	3372	130	3742	46, 48	40509	201	4302	197
1851	232	2011	108	3037	188, 189	3206	194,195	3373	130	3743	45	40510	201	4303	198
1852	230	2012	112,113	3040	186	3208	193	3379	130	3745	46	4112	10, 45,	4304	198
1853	231	2014	117	3041	143	3209	194	3390	60	3746	44	55		4307	197
1856	230	2015	110,111,	3050	194	3210	192	3401	148	3750	49	4134	219	4308	197
1858	230		113, 115, 116, 117	3052	225	3211	192	3410	52	3751	49	4140	162	4336	222
1859	230	2016	114, 115	3065	191	3221	248	3411	52	3752	50	4150	211	4337	163
		2017	116												

Code	Page	Code	Page	Code	Page	Code	Page	Code	Page	Code	Page	Code	Page	Code	Page
4338	163	178		4937	171	5618	11	6446	79	8185	37	C392	99	S353	89
4343	195	4719	177	4938	171	5619	11	6447	79, 81	8187	38	C716	100	S374	95,99,103
4344	170,193,194	4720	146	4949	248	5630	16	6448	78	8188	38	M090	103	S380	98,102,103
4346	221	4740	151	4959	247	5634	16	6449	79	8237	173	M193	102	S384	98, 102
4347	204,220,222	4745	151	4970	156	5635	16	6450	78, 79, 81	8300	28	M245	92	S386	95, 97,
4348	221	4761	159	5020	23	5640	13	6451	79	8304	29	M340	87		101, 103
4349	221	4766	179	5023	23	5651	13	6453	81	8308	30	M516	92, 100	S387	98, 101
4357	170	4770	202	5026	24	5652	12	6454	80	8309	28	M888	96	S392	84, 92, 99
4358	169	4781	200	5050	25	5654	10	6460	76	8310	29	M993	102	S393	102
4359	169	4782	138	5051	25	5670	15	6461	77	8311	29	P222	91		
4361	199	4783	138	5110	17	5680	14	6462	76	8313	30	P223	91		
4362	199	4788	147	5111	18	5710	8	6463	76	8317	30	P224	92		
4370	148	4789	147	5113	19	5714	8	6464	76	8320	173	P227	91		
4409	162	4802	224	5114	19	5715	8	6465	76	8359	16,31,55	P230	84, 90,		
4441	61	4805	224	5120	18	6200	81, 206	6466	77	8360	55		91, 94		
4530	130	4807	224	5130	18	6202	81, 206	6467	77	8362	31	P240	86		
4582	196	4813	37, 145	5131	18	6206	66	6468	77	8363	31	P245	87, 93		
4591	158	4815	148	5140	19	6224	67	6572	206	8440	33	P246	88		
4604	132	4816	146	5141	19	6230	66	6580	81	8450	33	P247	88		
4605	132	4826	148	5290	24	6232	68	6581	81	8460	33	P249	89		
4636	25,30,163	4827	139	5291	24	6236	67	6820	81, 191	8470	33	P251	90		
4650	161	4840	199	5293	25	6241	68	7291	157	8480	32	P253	89		
4665	206	4843	178	5300	21	6242	69	7293	157	8481	34	P256	90		
4670	199	4844	179	5303	22	6243	68	7350	156	8485	33	P274	95, 99,		
4682	155	4856	220	5314	22	6244	68	7360	166	8780	35		103		
4683	154,155	4858	200	5320	166	6247	69	7362	166	8800	199	P280	98, 102,		
4685	154	4859	220	5321	166	6306	70	7366	174	8967	172		103		
4687	155	4863	219	5340	21	6324	71	7367	167	C030	84, 90,	P284	98, 102		
4700	177	4870	140	5350	174	6330	70	7368	167		91, 94	P286	95, 97,		
4701	178	4871	140	5353	174	6332	71	7664	38	C040	87		101, 103		
4702	177	4872	140	5356	175	6336	71	8030	38	C045	88, 94	P287	98, 101		
4703	178	4873	141	5357	175	6342	71	8040	39	C046	88	P292	84,92,99		
4705	176	4874	141	5358	175	6406	72	8050	39	C047	89	P293	102		
4706	176	4875	141,157,169	5359	175	6424	72, 75	8060	39	C049	89	P374	95		
4707	176	4876	141	5362	166	6425	75	8070	39	C092	84, 92	S322	91		
4708	176	4880	199	5363	166	6426	75	8090	36	C108	103	S323	91		
4709	176	4881	159, 160	5530	20	6427	75	8091	37	C192	99	S324	92		
4710	178	4882	159	5540	20	6430	73	8136	174	C284	98, 102	S327	91		
4711	178	4884	158, 206	5550	18	6432	80	8137	174	C286	95, 96,	S330	84, 90,		
4712	178	4885	159,160,161	5610	9	6436	73	8140	37		97, 101		91, 94		
4713	179	4886	158	5611	12	6440	73	8161	168	C287	98, 101	S340	86		
4714	179	4887	158	5612	12, 13	6441	73	8162	167	C292	99	S345	87, 93		
4715	179	4891	151	5613	9	6442	73	8180	36	C384	98, 102	S346	88		
4716	179	4920	162	5614	10	6443	74	8181	36	C386	95, 96,	S347	88		
4717	177	4931	170	5615	12	6444	74	8183	37	97, 101		S349	89		
4718	177,	4935	171	5616	12	6445	78, 81	8184	36	C387	98, 101	S351	90		

DE BUYER'S PARTNERS





de Buyer company became in April 2018 the only player in the culinary sector certified «committed to CSR - Confirmed level» by AFNOR.

This evaluation covers all subjects that are close to its heart, such as human resources, the environment, responsible purchasing, sustainable products as well as territorial involvement.

It is a part of a continuous improvement process.





de Buyer Industries
25, Faymont - 88340 Le Val d'Ajol - FRANCE
TEL: + 33 (0)3 29 30 66 12
info@debuyer.com - www.debuyer.com
SIRET 403 467 574 00014 TVA FR68 403 467 574

