

BOMANN®



Home Appliances 2019/1

CONTENT



Coffee machines	6
Coffee grinder	8
Espresso machine	8
Kettle	10
Milk frother	9



Crêpe maker	15
Egg boiler	19
Ice cream cone maker	15
Ice cube maker	18
Muffin maker	16
Multigrills	17
Pepper/salt mill	19
Sandwich toaster	16
Soft ice maker	18
Toaster	12
Waffle maker	14



Automatic juicer	32
Bag sealer	34
Citrus fruit squeezer	31
Deep fat fryers	35
Fondue deep fat pan	34

Food processor	34
Metal food slicer	19
Hand blender	20
Hand blender set	21
Hand mixer	22
Hand mixer sets	23
Kitchen scales	33
Kneading machines	24
Mincer	29
Multi chopper	22
Smoothie maker	31
Spiral cutter	21
Universal mixer	30



Bread maker	38
Barbecue standing grill	40
Barbecue table grill	41
Built-in microwaves with grill	47
Contact grill	39
Convection oven	42
Hot dog maker	38
Hotplates	48
Induction hot plates	50
Microwaves	44
Multi oven	43
Multi pizza oven	43
Raclette grills	39
Rice boiler	37
Vertical Kebab Multigrill	42



Steam irons	52
Steam ironing stations	54
Shirt and blouse presser	55
Textile cleaner	51



Battery floor vacuum cleaner	59
Battery vacuum cleaner	57
Floor vacuum cleaner	60
Hand vacuum cleaner	58
Shampoo cleaner	64
Steam cleaner	56
Wet and dry cleaner	63



Bathroom scales	65
Foot massage equipment	65
Hair and beard trimmer	66
Hair dryer	67
Nose and ear hair remover	66
Hot air curling brush	67



Accessoires	79
Cool bag	72
Cool boxes	73
Electric fireplaces	75
Ventilators	69
Fan heater	70



Coffee machine KA 3003 CB

- For 15 cups of coffee (approx. 1.7 litre)
- Stainless steel insert
- Anti-drip protection
- Filter holder (removable)
- On/off switch with indicator light
- Water level indicator
- Heating plate with automatic switch-off
- 220–240 V, 50/60 Hz, 1000 W

Toaster TA 3005 CB

- 2-slice toaster
- Stainless steel insert
- Cool touch housing
- Bun warmer (removable)
- Defrost/reheat/quick-stop function
- Continuously adjustable thermostat
- 3 indicator lights (white illuminated)
- Automatic/manual switch-off
- Crumb drawer
- Cord storage
- 220–240 V, 50 Hz, 850 W max.

Kettle WK 3004 CB

- Max. capacity 1.7 litre
- Stainless steel insert
- Simple handling due to cable-free technology – easy to pour in and out
- 360° connector
- Safety hinged lid with one-handed operation
- Lime filter (removable)
- On/off switch (illuminated)
- Concealed stainless steel heating element
- Automatic/manual switch-off
- 2 external water level indicators
- Base station with cord storage
- Evaporation/overheating protection
- 220–240 V, 50/60 Hz, 1850–2200 W



Coffee machine

KA 3003 CB

- For 15 cups of coffee (approx. 1.7 litre)
- Stainless steel insert
- Anti-drip protection
- Filter holder (removable)
- On/off switch with indicator light
- Water level indicator
- Heating plate with automatic switch-off
- 220–240 V, 50/60 Hz, 1000 W

Toaster

TA 3005 CB

- 2-slice toaster
- Stainless steel insert
- Cool touch housing
- Bun warmer (removable)
- Defrost/reheat/quick-stop function
- Continuously adjustable thermostat
- 3 indicator lights (white illuminated)
- Automatic/manual switch-off
- Crumb drawer
- Cord storage
- 220–240 V, 50 Hz, 850 W max.

Kettle

WK 3004 CB

- Max. capacity 1.7 litre
- Stainless steel insert
- Simple handling due to cable-free technology – easy to pour in and out
- 360° connector
- Safety hinged lid with one-handed operation
- Lime filter (removable)
- On/off switch (illuminated)
- Concealed stainless steel heating element
- Automatic/manual switch-off
- 2 external water level indicators
- Base station with cord storage
- Evaporation/overheating protection
- 220–240 V, 50/60 Hz, 1850–2200 W



1 cup coffee machine
KA 201 CB

- 1 cup coffee machine for filter coffee
- Space-saving design (ideal when out and about)
- Includes one ceramic cup
- Permanent nylon filter (removable)
- On/off switch with indicator light
- Automatic power off
- Non-slip tray (removable)

- 220–240 V, 50 Hz, 270–330 W
- WxHxD approx. 130 x 175 x 155 mm

Coffee machine
KA 183 CB

- For 12–14 cups of coffee (approx. 1.5 litre)
- Anti-drip protection
- Filter holder (removable)
- On/off switch (illuminated)
- Water level indicator
- Heating plate with automatic switch-off
- Cord storage

- 230 V, 50 Hz, 900 W
- WxHxD approx. 190 x 330 x 205 mm

Coffee machine
KA 183 CB

- For 12–14 cups of coffee (approx. 1.5 litre)
- Anti-drip protection
- Filter holder (removable)
- On/off switch (illuminated)
- Water level indicator
- Heating plate with automatic switch-off
- Cord storage

- 230 V, 50 Hz, 900 W
- WxHxD approx. 190 x 330 x 205 mm



Can also be combined as a suitable kitchen set

● Art. no. 602 011
EAN 4 004 470 020 113 PU 6



● Art. no. 601 830
EAN 4 004 470 018 301 PU 6
● Art. no. 601 833
EAN 4 004 470 018 332 PU 6



● Art. no. 601 831
EAN 4 004 470 018 318 PU 6
● Art. no. 601 832
EAN 4 004 470 018 325 PU 6





Coffee machine
KA 3003 CB

Coffee machine
KA 1369 CB

Thermo coffee machine
KA 168 CB

- For 15 cups of coffee (approx. 1.7 litre)
- Stainless steel insert
- Anti-drip protection
- Filter holder (removable)
- On/off switch with indicator light
- Water level indicator
- Heating plate with automatic switch-off

- 220–240 V, 50/60 Hz, 1000 W
- WxHxD approx. 220 x 340 x 260 mm

- For 12–14 cups of coffee (approx. 1.5 litre)
- High-quality stainless steel application
- Anti-drip protection
- Filter holder (removable)
- On/off switch with indicator light (blue illuminated)
- Water level indicator
- Heating plate with automatic switch-off

- 220–240 V, 50/60 Hz, 900 W
- WxHxD approx. 180 x 325 x 260 cm

- For 8–10 cups of coffee (approx. 1.0 litre)
- Thermo jug (double-walled)
- Anti-drip protection
- Filter holder (removable)
- On/off switch with indicator light
- Automatic power off
- Water level indicator

- 220–240 V, 50/60 Hz, 730–870 W
- WxHxD approx. 185 x 340 x 210 mm



Can also be combined as a suitable breakfast set

● Art. no. 630 031
EAN 4 004 470 300 314 PU 4
● Art. no. 630 032
EAN 4 004 470 300 369 PU 4

● Art. no. 613 691
EAN 4 004 470 136 913 PU 4

● Art. no. 601 680
EAN 4 004 470 016 802 PU 6
● Art. no. 601 683
EAN 4 004 470 016 871 PU 6





Stainless steel housing

8

Thermo coffee machine KA 1370 CB

- For 8–10 cups of coffee (approx. 1.2 litre)
- Stainless steel thermo jug (double-walled) with aroma seal – drinks remain hot for longer
- High-quality stainless steel application
- Anti-drip protection
- Filter holder (removable)
- On/off switch with indicator light (blue illuminated)
- Automatic power off
- Water level indicator
- 220–240 V, 50 Hz, 800 W
- WxHxD approx. 180 x 325 x 260 cm



Double-walled thermo jug with aroma seal – drinks remain hot for longer

Espresso machine ES 1185 CB

- Espresso and cappuccino pump machine
- Stainless steel front
- Swiveling stainless steel steam nozzle with foaming and hot water function
- Steam volume steplessly adjustable
- Steam nozzle tip removable for easy cleaning
- Cup warming function with stainless steel insert
- Constant pump pressure of 15 bar
- 1.6 litre transparent water tank (removable)
- External water level indicator
- Collection cup with stainless steel drip grid (removable)
- 2 indicator lights
- Automatic shut-off
- Operational readiness indication
- Accessories: 2 filter holders (1 and 2 cups), coffee scoop, tamper
- 220–240 V, 50 Hz, 850 W
- WxHxD approx. 250 x 295 x 280 mm



Cup warming function



Swiveling stainless steel steam nozzle with foaming and hot water function

Coffee grinder KSW 445 CB

- Electric coffee mill with beater
- Stainless steel beater blade
- Stainless steel bean container, hygienic and with aroma protection
- Transparent lid
- Capacity 40 g – for 20 cups of coffee
- With 120 watt motor
- Safety circuit – operation only possible with lid in place
- Safety pushbutton also for pulsed operation
- Degree of grinding can be selected by the length of operation
- Cord storage
- 220–240, 50 Hz, 120 W
- WxHxD approx. 100 x 200 x 100 mm

Art. no. 613 701
EAN 4 004 470 137 019 PU 4



4 004470 137019

Art. no. 611 851
EAN 4 004 470 118 513 PU 2



4 004470 118513

Art. no. 604 451
EAN 4 004 470 044 515 PU 6



4 004470 044515



Cold and warm foaming function

Coffee grinder
KSW 446 CB

- Electric coffee mill with beater
- Stainless steel beater blade
- Stainless steel bean container, hygienic and with aroma protection
- Transparent lid
- Capacity 40 g – for 20 cups of coffee
- With 120 watt motor
- Safety circuit – operation only possible with lid in place
- Safety pushbutton also for pulsed operation
- Degree of grinding can be selected by the length of operation
- Cord storage
- 220–240 V, 50 Hz, 120 W
- WxHxD approx. 100 x 200 x 100 mm

Milk frother
MS 479 CB

- Integrated heating function
- Creates foamy milk in seconds
- Also suitable for hot and cold chocolate
- Stainless steel container (700 ml)
- Insulated soft-touch coating
- Foamed milk volume: approx. 500 ml
- Electronic 2-function switch
 - Froth the milk warm
 - Froth the milk cold – ideal for iced coffee
 - Heat the milk
- Built-in heating element
- Automatic switch-off function
- Incl. lid with splash guard function
- Additional stirrer for hot drinks without frothing (e.g. cocoa)
- Mixing bowl and lid removable for easy cleaning
- 220–240 V, 50 Hz, 550–650 W
- WxHxD approx. 105 x 240 x 105 mm

Milk frother
MS 344 CB

- Creates foamy milk in seconds
- Soft touch housing
- Stainless steel whisk
- Easy to clean
- Battery operation: 2 x 1,5 V AA/UM 3 (batteries not included)
- WxHxD approx. 47 x 225 x 32 mm



Kettle
WK 5024 CB

- Max. capacity 1.0 litre
 - Simple handling due to cable-free technology – easy to pour in and out
 - Safety hinged lid with one-handed operation
 - Lime filter (removable)
 - On/off switch (illuminated)
 - Stainless steel heating element
 - Automatic/manual switch-off
 - 2 external water level indicators
 - Rubber profile on the handle
 - Incl. base station
 - Evaporation/overheating protection
- 220–240 V, 50 Hz, 750–900 W
■ WxHxD approx. 185 x 220 x 115 mm

Kettle
WK 5011 CB

- Max. capacity 1.7 litre
 - Simple handling due to cable-free technology – easy to pour in and out
 - Safety hinged lid with one-handed operation
 - Lime filter (removable)
 - On/off switch (illuminated)
 - Stainless steel heating element
 - Automatic/manual switch-off
 - 2 external water level indicators
 - Rubber profile on the handle
 - Base station with cord storage
 - Evaporation/overheating protection
- 220–240 V, 50 Hz, 1850–2200 W
■ WxHxD approx. 220 x 255 x 140 mm

Kettle
WK 5011 CB

- Max. capacity 1.7 litre
 - Simple handling due to cable-free technology – easy to pour in and out
 - Safety hinged lid with one-handed operation
 - Lime filter (removable)
 - On/off switch (illuminated)
 - Stainless steel heating element
 - Automatic/manual switch-off
 - 2 external water level indicators
 - Rubber profile on the handle
 - Base station with cord storage
 - Evaporation/overheating protection
- 220–240 V, 50 Hz, 1850–2200 W
■ WxHxD approx. 220 x 255 x 140 mm

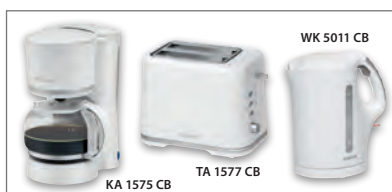

Can also be combined as a suitable breakfast set



Can also be combined as a suitable kitchen set

- Art. no. 650 240
EAN 4 004 470 502 404 PU 6
- Art. no. 650 241
EAN 4 004 470 502 411 PU 6



- Art. no. 650 110
EAN 4 004 470 501 100 PU 6
- Art. no. 650 113
EAN 4 004 470 501 131 PU 6
- Art. no. 650 111
EAN 4 004 470 501 117 PU 6



- Art. no. 650 118
EAN 4 004 470 501 186 PU 6
- Art. no. 650 119
EAN 4 004 470 501 193 PU 6





 Stainless steel

Kettle
WK 5012 CB

- Max. capacity 1.8 litre
 - Simple handling due to cable-free technology – easy to pour in and out
 - 360° connector
 - Lockable safety hinged lid with one-handed operation
 - Lime filter (removable)
 - On/off switch (illuminated)
 - Concealed stainless steel heating element
 - Automatic/manual switch-off
 - 2 external water level indicators
 - Base station with cord storage
 - Overheating protection
- 220–240 V, 50 Hz, 1850–2200 W
■ WxHxD approx. 225 x 255 x 150 mm

Kettle
WK 3004 CB

- Max. capacity 1.7 litre
 - Stainless steel insert
 - Simple handling due to cable-free technology – easy to pour in and out
 - 360° connector
 - Safety hinged lid with one-handed operation
 - Lime filter (removable)
 - On/off switch (illuminated)
 - Concealed stainless steel heating element
 - Automatic/manual switch-off
 - 2 external water level indicators
 - Base station with cord storage
 - Evaporation/overheating protection
- 220–240 V, 50/60 Hz, 1850–2200 W
■ WxHxD approx. 220 x 250 x 155 mm

Kettle
WKS 3002 CB

- Max. capacity 1.5 litre
 - Stainless steel housing
 - Simple handling due to cable-free technology – easy to pour in and out
 - 360° connector
 - Safety hinged lid with one-handed operation
 - On/off switch (blue illuminated)
 - Concealed stainless steel heating element
 - Automatic/manual switch-off
 - Base station with cord storage
 - Evaporation/overheating protection
- 220–240 V, 50 Hz, 1850–2200 W
■ WxHxD approx. 230 x 233 x 142 mm



Can also be combined as a suitable breakfast set

● Art. no. 650 120
EAN 4 004 470 501 209 PU 6
● Art. no. 650 123
EAN 4 004 470 501 216 PU 6



● Art. no. 630 041
EAN 4 004 470 300 413 PU 4
● Art. no. 630 042
EAN 4 004 470 300 420 PU 4



● Art. no. 630 022
EAN 4 004 470 300 321 PU 6
● Art. no. 630 021
EAN 4 004 470 300 215 PU 6





Stainless steel

12

Kettle WKS 1356 CB

- Max. capacity 1.7 litre
 - Simple handling due to cable-free technology – easy to pour in and out
 - 360° connector
 - Lockable safety hinged lid
 - Lime filter (removable and washable)
 - On/off switch
 - Indicator light (blue illuminated)
 - Stainless steel thermo housing
 - Concealed stainless steel heating element
 - Automatic/manual switch-off
 - 2 external water level indicators
 - Base station with cord storage (stainless steel sheathed)
 - Evaporation/overheating protection
- 220–240 V, 50 Hz, 1850–2200 W
■ W x H x D approx. 220 x 250 x 145 mm

NEW! Glass kettle WKS 6026 G CB

- Max. capacity 1.7 litre
 - Glass/stainless steel housing
 - Water container made of heat-resistant safety glass
 - Locked stainless steel lid with one-handed operation
 - Simple handling due to cable-free technology – easy to pour in and out
 - 360° connector
 - On/off switch (blue illuminated)
 - Concealed stainless steel heating element
 - Automatic/manual switch-off
 - Water level indicator
 - Base station with cord storage
 - Evaporation/overheating protection
- 220–240 V, 50 Hz, 1850–2200 W
■ W x H x D approx. 215 x 240 x 160 mm

Toaster TA 246 CB

- Compact 2-slice toaster
 - Cool touch housing
 - Bun warmer (integrated)
 - Defrost/reheat/quick-stop function
 - Continuously adjustable thermostat
 - 2 indicator lights
 - Automatic/manual switch-off
 - Crumb drawer
 - Base station with cord storage
- 220–240 V, 50/60 Hz, 600–700 W
■ W x H x D approx. 285 x 240 x 165 mm



Glass/stainless steel housing

Art. no. 613 561
EAN 4 004 470 135 619 PU 6



4 004470 135619

Art. no. 660 252
EAN 4 004 470 602 531 PU 4



4 004470 602531

Art. no. 602 460
EAN 4 004 470 024 609 PU 6
Art. no. 602 463
EAN 4 004 470 024 630 PU 6



4 004470 024609



Toaster
TA 1577 CB

Toaster
TA 1577 CB

Toaster
TA 3005 CB

- Compact 2-slice toaster
 - Cool touch housing
 - Bun warmer (removable)
 - Defrost/reheat/quick-stop function
 - Continuously adjustable browning
 - 3 indicator lights (blue illuminated)
 - Automatic/manual switch-off
 - Crumb drawer
 - Cord storage
- 220–240 V, 50/60 Hz, 870 W max.
 - WxHxD approx. 260 x 170 x 145 mm

- Compact 2-slice toaster
 - Cool touch housing
 - Bun warmer (removable)
 - Defrost/reheat/quick-stop function
 - Continuously adjustable browning
 - 3 indicator lights (blue illuminated)
 - Automatic/manual switch-off
 - Crumb drawer
 - Cord storage
- 220–240 V, 50/60 Hz, 870 W max.
 - WxHxD approx. 260 x 170 x 145 mm

- 2-slice toaster
 - Stainless steel insert
 - Cool touch housing
 - Bun warmer (removable)
 - Defrost/reheat/quick-stop function
 - Continuously adjustable thermostat
 - 3 indicator lights (white illuminated)
 - Automatic/manual switch-off
 - Crumb drawer
 - Cord storage
- 220–240 V, 50/60 Hz, 850 W max.
 - WxHxD approx. 295 x 185 x 185 mm



Can also be combined as a suitable kitchen set



Can also be combined as a suitable breakfast set



Can also be combined as a suitable breakfast set

● Art. no. 615 772
EAN 4 004 470 157 727 PU 6
● Art. no. 615 773
EAN 4 004 470 157 734 PU 6

● Art. no. 615 770
EAN 4 004 470 157 703 PU 6
● Art. no. 615 771
EAN 4 004 470 157 710 PU 6

● Art. no. 630 051
EAN 4 004 470 300 512 PU 4
● Art. no. 630 052
EAN 4 004 470 300 529 PU 4





 **Stainless steel housing**

14

Toaster
TA 1371 CB

- 2-slice toaster
- Stainless steel housing
- Bun warmer (removable)
- Defrost/reheat/quick-stop function (blue illuminated)
- Continuously adjustable thermostat
- Centring function
- Automatic/manual switch-off
- Crumb drawer
- Cord storage
- 220–240 V, 50/60 Hz, 750–850 W
- W x H x D approx. 270 x 180 x 150 mm

Toaster
TA 245 CB

- 4-slice long-slot toaster
- Heat-insulated cool touch housing
- Bun warmer (removable)
- Defrost/reheat/quick-stop function
- Continuously adjustable browning
- 3 LED indicator lights
- Automatic switch-off
- Crumb drawer
- Cord storage
- 220–240 V, 50/60 Hz, 1200–1400 W
- W x H x D approx. 375 x 175 x 165 mm

Waffle maker
WA 5018 CB

- Large baking plates: approx. Ø 18 cm (non-stick coated)
- Heat insulated handle
- Continuously adjustable thermostat
- 2 indicator lights for power and heating (baking lights)
- High stability due to rubberized feet
- Overheating protection
- 220–240 V, 50 Hz, 1200 W
- W x H x D approx. 205 x 115 x 250 mm



Defrost/reheat/
quick-stop function
(blue illuminated)

● **Art. no. 613 711**
EAN 4 004 470 137 118 PU 4



● **Art. no. 602 450**
EAN 4 004 470 024 500 PU 6



● **Art. no. 650 180**
EAN 4 004 470 616 798 PU 6
● **Art. no. 650 181**
EAN 4 004 470 501 810 PU 6





Waffle maker
WA 1365 CB

- Stainless steel insert
- Large baking plates: approx. Ø 18 cm (non-stick coated)
- Heat insulated handle
- Continuously adjustable thermostat
- 2 indicator lights for power and heating (baking lights)
- Overheating protection

- 220–240 V, 50/60 Hz, 1000 W
- W x H x D approx. 200 x 100 x 260 mm

Ice cream cone maker
HA 5017 CB

- Large baking plate: approx. Ø 18 cm (non-stick coated)
- Heat insulated handle
- Continuously adjustable thermostat
- 2 indicator lights for power and heating (baking lights)
- High stability due to rubberized feet
- Incl. squirrel cone
- Overheating protection

- 220–240 V, 50 Hz, 1200 W
- W x H x D approx. 205 x 115 x 250 mm

Crêpe maker
CM 2221 CB

- Large baking plate: approx. Ø 29 cm (non-stick coated)
- Paper-thin crêpes, quickly and easily prepared
- Heat-insulated plastic base
- Continuously adjustable thermostat
- 2 indicator lights for power and heating (baking lights)
- Base station with cord storage
- Incl. batter distributor

- 220–240 V, 50/60 Hz, 900 W
- W x H x D approx. 325 x 80 x 370 mm



Stainless steel insert



Incl. squirrel cone



Incl. batter distributor

Art. no. 613 651
 EAN 4 004 470 616 811 PU 4



Art. no. 650 171
 EAN 4 004 470 616 835 PU 6



Art. no. 622 211
 EAN 4 004 470 222 111 PU 4





16

Muffin maker MM 5020 CB

- For baking up to 7 muffins
- Muffin diameter approx. 4.5 cm
- Baking surfaces non-stick coated
- Heat insulated handle
- 2 indicator lights for power and heating (baking lights)
- High stability due to rubberized feet
- Overheating protection
- 220–240 V, 50/60 Hz, 900 W
- WxHxD approx. 225 x 115 x 225 mm

Sandwich toaster ST 5016 CB

- Triangular sandwich plates
- Non-stick coating
- Heat insulated handle
- Automatic temperature controller
- 2 indicator lights for power and heating (baking lights)
- Locking system
- Safety shutdown
- Overheating protection
- 220–240 V, 50/60 Hz, 750 W
- WxHxD approx. 230 x 80 x 230 mm

Sandwich toaster ST 1372 CB

- Stainless steel insert
- Triangular sandwich plates
- Non-stick coating
- Heat insulated handle
- Automatic temperature control
- 2 indicator lights for power and heating (baking lights)
- High stability due to rubberized feet
- Locking system
- Overheating protection
- 220–240 V, 50/60 Hz, 750 W
- WxHxD approx. 235 x 95 x 235 mm



Stainless steel insert

Art. no. 650 201
EAN 4 004 470 616 859 PU 6



4 004470 616859

Art. no. 650 160
EAN 4 004 470 501 605 PU 6
Art. no. 650 163
EAN 4 004 470 501 636 PU 6



4 004470 501605

Art. no. 613 721
EAN 4 004 470 637 359 PU 6



4 004470 637359



3in1

Stainless steel housing

Multi grill ST/WA 1364 CB

- Sandwich toaster, waffle maker and contact grill
- Versatile use by three different removable plates (sandwich/waffle/grill plates), e.g. for Belgian waffles and tasty sandwich variations, as well as for fast two-sided contact grilling
- Stainless steel insert
- Baking plates non-stick coated and changeable
- Heat insulated handle
- 2 indicator lights for power and heating (baking lights)
- High stability due to rubberized feet
- Locking system
- Overheating protection
- 230 V, 50/60 Hz, 650 W
- W x H x D approx. 230 x 100 x 225 mm

Multi grill MG 2251 CB

- Multi grill for double-sided, fat-free grilling
- 700 watt
- Stainless steel housing
- Short cooking times
- Non-stick grill plates with extra deep grooves for strong grill pattern
- Heat insulated handle
- Indicator light
- Grilling surfaces: 23 x 14.5 cm
- Cord storage
- Versatile, can be used for e.g. panini, steaks, fish or vegetables
- 220–240 V, 50/60 Hz, 700W
- W x H x D approx. 270 x 95 x 230 mm

17



Stainless steel insert



Sandwich plates, waffle plates, grill plates



Stainless steel housing

Art. no. 613 641
EAN 4 004 470 616 781 PU 4



4 004470 616781

Art. no. 622 511
EAN 4 004 470 225 112 PU 6



4 004470 225112



18

Ice cube maker EWB 1027 CB

- Compact ice cube maker without complicated installation for producing ice cubes quickly and simply at the press of a button
 - Ideal for home use, in offices, when camping or for small bars
 - No water pipe required, simply fill water into the tank (2.2 l water tank)
 - Approx. 10–15 kg of ice cubes in 24 hours (approx. 90 g in 10 min – corresponding to 9 ice cubes)
 - LED display and acoustic signal when the ice cube container is full or the water tank is empty
 - Energy-saving mode – automatic switch-off at the end of the program
 - On/off switch
 - 3 indicator lights (ice full, empty water, operation)
 - Visual check through viewing window in the lid
 - Low-noise
- 220–240 V, 50/60 Hz, 95 W (Cooling), 165 W (spending ice cubes)
 - W x H x D approx. 245 x 330 x 370 mm



LED displays



For approx. 10–15 kg ice cubes

Soft ice cream maker ICM 387 CB

- Soft ice cream maker with discharge valve for preparation of soft ice cream, ice cream, frozen yogurt, and sorbet
 - Transparent lid with refill opening
 - With portioner – ice dispensed directly from the machine
 - On/off switch
 - Incl. recipe suggestions
 - For up to 1000 ml ice cream
 - Double-walled ice cream maker with cold storage, removable for easy cleaning (H: 14 cm; Ø 17 cm)
 - Stirring element with powerful, quiet motor
 - High stability due to rubberized feet
- 220–240 V, 50 Hz, 18 W
 - W x H x D approx. 220 x 440 x 225 mm



Soft ice cream maker with discharge valve

Art. no. 610 271
EAN 4 004 470 102 710 PU 1



4 004470 102710

Art. no. 603 870
EAN 4 004 470 038 705 PU 2



4 004470 038705



Egg boiler
EK 5022 CB

Electric pepper/salt mill
PSM 437 CB N

Metal food slicer
MA 451 CB

- Preparation of up to 6 eggs
- Heating dish (non-stick coated)
- On/off switch (illuminated)
- Acoustic signal (buzzer)
- Removable egg holder
- Incl. measuring beaker with egg pricker
- 230 V, 50 Hz, 400 W
- WxHxD approx. 220 x 130 x 135 mm

- High-quality precision ceramic grinder
- Stainless steel housing
- Adjustable ceramic grinder (from coarse to fine)
- Consistent grinding quality
- Simple refilling
- Single-handed operating
- Incl. light for optimum dosing of the condiment
- Battery-operated
- Battery operation: 4x1,5 V AA/Mignon/LR/AM3 (batteries not included)
- WxHxD approx. 45 x 220 x 45 mm

- Big stainless steel blade (Ø 190 mm), rustproof
- Universal serrated blade
- Motor housing: aluminium die cast
- On/off switch
- Metal guiding rail
- Metallic guiding board
- Food grip with finger protection
- Continuously adjustable cutting size (0–15 mm)
- Tilted supporting table with stainless steel insert, tiltable for easy cleaning
- High stability due to suction feet
- 220–240 V, 50/60 Hz, 150 W
- WxHxD approx. 365 x 235 x 265 mm



● Art. no. 650 220
 EAN 4 004 470 616 866 PU 6
● Art. no. 650 223
 EAN 4 004 470 502 237 PU 6
● Art. no. 650 228
 EAN 4 004 470 502 282 PU 6

● Art. no. 604 372
 EAN 4 004 470 043 723 PU 6

● Art. no. 604 510
 EAN 4 004 470 045 109 PU 2





Incl. transparent mixing vessel

Hand blender
SM 354 CB

- Stainless steel cutting blade
- On/off switch (countersunk)
- Incl. transparent mixing vessel (500 ml)
- Hanging loop
- Wall holder plus attachment materials
- 220–240 V, 50 Hz, 180 W
- W x H x D approx. 80 x 330 x 80 mm

Hand blender
SM 384 CB

- Stainless steel cutting blade (rustproof)
- On/off switch (countersunk)
- Powerful 180 watt motor
- Incl. transparent mixing vessel (500 ml)
- Hanging loop
- 220–240 V, 50 Hz, 180 W
- W x H x D approx. 80 x 330 x 80 mm

NEW! **Hand blender**
SM 6028 CB

- Soft touch housing
- Stainless steel insert
- 2-level pushbutton switch
- Powerful 800 watt motor
- Stainless steel cutting blade
- Removable stainless steel hand blender
- Ergonomically shaped handle
- Hanging loop
- 220–240 V, 50/60 Hz, 800 W
- W x H x D approx. 65 x 370 x 65 mm



Incl. transparent mixing vessel (500 ml)



Can also be combined as a suitable kitchen set

Art. no. 603 540
EAN 4 004 470 035 407 PU 12



Art. no. 603 842
EAN 4 004 470 038 422 PU 8
Art. no. 603 846
EAN 4 004 470 038 460 PU 8



Art. no. 660 281
EAN 4 004 470 602 814 PU 6





3in1

Hand blender set SMS 349 CB

- Hand blender set – stainless steel hand blender, multiple chopper and whisk in one
 - Working container with scale (0,5 litre)
 - Powerful 200 watt motor
 - 2 speeds
 - Removable metal whisk
 - Ergonomically shaped rubberised handle for easier handling
 - Holder for metal whisk and stainless steel hand blender
 - Incl. mixing vessel with scale (0.7 litre)
 - Hanging loop
- 220–240 V, 50/60 Hz, 200 W
 - W x H x D approx. 160 x 370 x 150 mm

Spiral cutter ME 470 CB

- Electric spiral cutter for decorative cutting of e.g. carrots, cucumbers, zucchini
 - Changeable high-quality drum attachments with stainless steel blade, for quick and easy spiral cutting
 - Easy and safe handling thanks to internal cutting unit
 - 3 functions
 - fine: 5 mm
 - medium: 10 mm
 - big: 55 mm
 - Powerful 80 watt motor
 - Large refill opening (ca. Ø 60 mm)
 - On/off switch
 - Storage for accessories
 - Transparent collecting container (dishwasher safe)
 - Base station with cord storage
 - High stability due to rubberized feet
 - Accessories: 3 drum attachments (fine/medium/big), collecting container
- 220–240 V, 50/60 Hz, 80 W
 - W x H x D approx. 238 x 380 x 138 mm



21



3x drum attachments
with stainless steel
blade (5/10/55 mm)

Storage for accessories

Art. no. 603 491
EAN 4 004 470 034 912 PU 6



4 004470 034912

Art. no. 604 700
EAN 4 004 470 047 004 PU 4



4 004470 047004



2in1

**Multi chopper
& ice-crusher**



Multi chopper
MZ 449 CB

- Mixing bowl (1 litre capacity)
- Removable chopping blade (rustproof)
- Incl. ice-crusher function
- Safe base
- Easy to clean
- 220-240 V, 50/60 Hz, 250 W
- WxHxD approx. 175 x 220 x 175 mm

Hand mixer
HM 350 CB

- Powerful 250 watt motor
- 5 speed level
- Eject button
- Stainless steel dough hooks and beaters
- All accessories are dishwasher-safe
- 230 V, 50 Hz, 250 W
- WxHxD approx. 180 x 280 x 90 mm

Hand mixer
HM 350 CB

- Powerful 250 watt motor
- 5 speed level
- Eject button
- Stainless steel dough hooks and beaters
- All accessories are dishwasher-safe
- 230 V, 50 Hz, 250 W
- WxHxD approx. 180 x 280 x 90 mm



Can also be combined as a suitable kitchen set

Art. no. 604 490
EAN 4 004 470 044 904 PU 6



Art. no. 603 500
EAN 4 004 470 035 001 PU 6



Art. no. 603 502
EAN 4 004 470 035 025 PU 6
Art. no. 603 506
EAN 4 004 470 035 063 PU 6





2in1

Hand mixer set HM 381 CB

- Powerful 300 watt motor
- 5 speed level
- Turbo setting
- Eject button
- Stainless steel dough hooks and beaters (21 cm) (dishwasher-safe)
- 220–240 V, 50/60 Hz, 300 W
- WxHxD approx. 90 x 145 x 200 mm



Incl. quick blender



2in1

Hand mixer set CB 336

- Powerful 250 watt motor
- 5 speed level
- Turbo setting
- Eject button
- Large mixing bowl with automatic drive
- Accessories: Stainless steel blade, 2 stainless steel beaters, 2 stainless steel dough hooks, quick blender mit stainless steel blade
- All accessories are dishwasher-safe
- 230 V, 50/60 Hz, 250 W
- WxHxD approx. 300 x 350 x 200 mm



Incl. quick blender

Art. no. 603 810
EAN 4 004 470 038 101 PU 6



Art. no. 603 360
EAN 4 004 470 033 601 PU 2





1100 Watt

5 litre
stainless steel dish
NEW! Kneading machine
KM 6010 CB

- High-performance kneading machine with powerful 1100 watt
 - Variable electronic speed control
 - 5 litre fine steel dish for max. 2.5–3 kg dough preparation
 - Aluminium die-cast stirring hook – also enables the uniform mixing of sizeable quantities of dough
 - Aluminium die-cast dough hook – for heavy doughs, e.g. yeast or bread dough
 - Stainless steel whisk for light sponge cake and fluffy egg whites
 - Special robust gear mechanism
 - 35° swivelling multifunction arm
 - Unlocking mechanism for multifunction arm
 - Safety circuit
 - Transparent splash protection lid with refill opening (removable)
 - Particularly easy to operate and clean
 - High stability due to suction feet
 - Quick-action chuck for holding the tools
- 220–240 V, 50 Hz, 1100 W
 - WxHxD approx. 350 x 320 x 210 mm



● Art. no. 660 101
EAN 4 004 470 601 015 PU 1
● Art. no. 660 102
EAN 4 004 470 601 022 PU 1



4 004470 601015



4 004470 601022

4.7 litre glass dish



Kneading machine

KM 1394 CB

25

- High-performance kneading machine with 1000 watt
 - 8 speed level (0-1-2-3-4-5-6 + pulse function)
 - 4.7 litre glass dish for max. 2.5–3 kg dough preparation
 - Aluminium die-cast stirring hook – also enables the uniform mixing of sizeable quantities of dough
 - Aluminium die-cast dough hook – for heavy doughs, e.g. yeast or bread dough
 - Stainless steel whisk for light sponge cake and fluffy egg whites
 - Special robust gear mechanism
 - Constant power through load-dependent, electronic speed control
 - 35° swivelling multifunction arm
 - Unlocking mechanism for multifunction arm
 - Safety circuit
 - Transparent splash protection lid with refill opening (removable)
 - Particularly easy to operate and clean
 - High stability due to suction feet
 - Quick-action chuck for holding the tools
- 220–240 V, 50/60 Hz, 1000 W
 - W x H x D approx. 364 x 312 x 284 mm

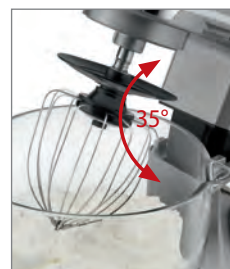

Art. no. 613 941
 EAN 4 004 470 139 419 PU 1



4 004470 139419

5 litre
stainless steel dish



26

Kneading machine KM 6009 CB

- High-performance kneading machine with powerful 1000 watt
 - Variable electronic speed control + pulse function
 - 5 litre stainless steel dish for max. 2.5–3 kg dough preparation
 - Aluminium die-cast stirring hook – also enables the uniform mixing of sizeable quantities of dough
 - Aluminium die-cast dough hook – for heavy doughs, e.g. yeast or bread dough
 - Stainless steel whisk for light sponge cake and fluffy egg whites
 - Special robust gear mechanism
 - 35° swivelling multifunction arm
 - Unlocking mechanism for multifunction arm
 - Safety circuit
 - Rotary switch (blue illuminated)
 - Transparent splash protection lid with refill opening (removable)
 - Particularly easy to operate and clean
 - High stability due to suction feet
 - Quick-action chuck for holding the tools
- 220–240 V, 50 Hz, 1000 W
 - WxHxD approx. 366 x 299 x 215 mm

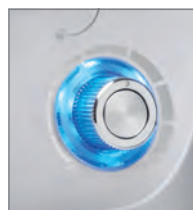

Rotary switch
(blue illuminated)

● Art. no. 660 091
EAN 4 004 470 600 919 PU 1



4 004470 600919

● Art. no. 660 090
EAN 4 004 470 600 902 PU 1



4 004470 600902

● Art. no. 660 092
EAN 4 004 470 600 926 PU 1



4 004470 600926



1200 Watt

6.3 litre

35° swivelling
multifunction arm



Kneading machine
KM 398 CB

- High-performance kneading machine with extra-powerful 1200 watt
 - 8 speed level (0-1-2-3-4-5-6 + pulse function)
 - 6.3 litre fine steel dish for max. 3–4 kg mixture preparation
 - Aluminium die-cast stirring hook (non-stick coated) – also enables the uniform mixing of sizeable quantities of dough
 - Aluminium die-cast dough hook (non-stick coated) – for heavy doughs, e.g. yeast or bread dough
 - Stainless steel whisk for light sponge cake and fluffy egg whites
 - Special robust gear mechanism
 - 35° swivelling multifunction arm with unlocking mechanism
 - Safety circuit
 - Transparent splash protection lid with refill opening (removable)
 - Particularly easy to operate and clean
 - High stability due to suction feet
 - Quick-action chuck for holding the tools
- 220–240 V, 50 Hz, 1200 W
 - WxHxD approx. 402 x 326 x 212 mm



Art. no. 603 980
EAN 4 004 470 039 801 PU 1

Art. no. 603 986
EAN 4 004 470 039 863 PU 1





Incl. glass mixing container with scale and refill opening (1.5 litre capacity)

XXL fine steel dish (6.2 litre)

4in1 1200 Watt



Pasta attachments, e.g. for spaghetti, macaroni and tagliatelle

Kneading machine
KM 1395 CB

- High-performance kneading machine with extra-powerful 1200 watt
- Electronic timer function / LCD display (illuminated in blue)
- Consistent performance due to load-dependent electronic rotation speed control
- 10 speed levels (0/1/2/3/4/5/6/7/8) + pulse function)
- Soft start for slow mixing
- 6.2 litre fine steel dish for max. 3–3.5 kg mixture preparation
- Glas mixing vessel with scale and filling aperture, 1.5 litre
- Aluminium die-cast stirring hook – also enables the uniform mixing of sizeable quantities of dough
- Aluminium die-cast dough hook – for heavy doughs e.g. yeast or bread dough
- Stainless steel whisk for light sponge cake and fluffy egg whites
- Sturdy special gears
- 35° swivelling multifunction arm with unlocking mechanism
- Transparent splash protection lid with filling aperture (detachable)
- Safety circuit
- Particularly easy to operate and clean
- Non-slip stand by suction feet
- Quick-action chuck for holding the tools



LCD display

Mincer

- Metal tube, metal cutter, 3 steel mincing disks, stainless steel cutter, sausage filler accessory, biscuit attachment, metal refill tray, attachment for oriental dumplings



Accessories: 3 different pasta attachments, metal cutter, metal tube, 3 stainless steel mincing disks, biscuit attachment, sausage filler accessory, kebbe attachment for oriental cuisine

Pastafunction

- Make pasta yourself with 3 different attachments, e.g. spaghetti, macaroni, tagliatelle
- 220–240 V, 50/60 Hz, 1200 W / WxHxD approx. 421 x 336 x 293 mm



Incl. mincer and pasta function



Glass mixing container with scale and refill opening

Art. no. 613 951
EAN 4 004 470 139 518 PU 1



4 004470 139518

ETM TESTMAGAZIN · URTEIL	
Bomann FW 447 CB	
GUT	82,5 %
Im Test: 13 Fleischwölfe Testurteile: 1x sehr gut, 12x gut www.etm-testmagazin.de	Heft 11/2015



5in1  **Stainless steel**

Food processor
KM 1382 CB

- Stainless steel housing
- 4 speed level (0-1-2 + pulse function)
- Mixing vessel with scale and refill opening (1.5 litre capacity)
- Working container with scale and refill opening (1.0 litre capacity)
- Cover for the refill opening can also be used as a measuring beaker (3 cl)
- High-grade, interchangeable attachments from stainless steel for cutting and grating
- Safety circuit
- Accessories (5in1): Mixing vessel with scale and refill opening (1.5 litre capacity), stainless steel cutting/grating insert, mixing blade, chopping blade, measuring cup (3 cl)
- High stability due to suction feet
- 220–240 V, 50 Hz, 500 W
- W x H x D approx. 190 x 370 x 190 mm



Accessories: 1x stainless steel cutting/grating insert, mixing blade, chopping blade

Incl. mixing vessel with scale and refill opening (1.5 litre capacity)



1200 Watt

Mincer
FW 447 CB

- Chrome-plated front plate
- Metal neck
- Metal feed tray
- Metal feed screw
- 3 stainless steel discs (7/5/3 mm)
- Stainless steel knife
- Reverse function
- Cookie maker attachment
- Sausage filler accessory
- Kebbe attachment – oriental cuisine
- On/off switch
- High stability due to suction feet
- 220–240 V, 50/60 Hz, 1200 W max.
- W x H x D approx. 330 x 355 x 170 mm



Integrated storage compartment for accessories

Incl. 3 stainless steel discs, cookie maker attachment, kebbe attachment, sausage filler accessory

Art. no. 613 821
EAN 4 004 470 138 214 PU 2



Art. no. 604 471
EAN 4 004 470 044 713 PU 4





Stainless steel

30

Universal mixer UM 378 CB

- Universal mixer for pureeing, beating, chopping, shaking and mixing
 - Ideal for preparing fruit and fitness drinks, milk shakes, cocktails, soups, salsa sauces, baby food
 - Ideal for kitchen and bar
 - Ice crush function
 - Powerful max. 500 watt motor
 - 5 speed level (0-1-2-3-4 + pulse/turbo function)
 - Removable mixing bowl (1.5 litre capacity)
 - Lid with refill opening
 - Cover for the refill opening can also be used as a measuring beaker (2 cl)
 - Stainless steel blade (rustproof)
 - Safety circuit – operation only possible with vessel in place
 - High stability due to rubberized feet
- 220–240 V, 50/60 Hz, 500 W max.
■ W x H x D approx. 160 x 400 x 160 mm

Universal mixer UM 1374 CB

- Stainless steel universal mixer for pureeing, beating, chopping up, shaking and mixing
 - Ideal for preparing fruit and fitness drinks, milk shakes, cocktails, soups, salsa sauces, baby food
 - Ideal for kitchen and bar
 - Stainless steel housing
 - Ice crush function
 - Powerful 650 watt motor
 - 4 speed level (0-1-2-3-4 + pulse function)
 - Removable mixing vessel made of solid glass with 1.5 litre capacity (with scale)
 - Lid with refill opening
 - Cover for the refill opening can also be used as a measuring beaker (6.5 cl)
 - 4-fold stainless steel blade with „piranha“ cut for easy mixing (rustproof)
 - Safety circuit – operation only possible with vessel in place
 - High stability due to rubberized feet
- 220–240 V, 50/60 Hz, 650 W
■ W x H x D approx. 177 x 400 x 175 mm

Art. no. 603 780
EAN 4 004 470 037 807 PU 4



4 004470 037807

Art. no. 613 741
EAN 4 004 470 137 415 PU 4



4 004470 137415



Mixing cup also suitable as drinking cup



Smoothie maker SM 386 CB

- Universal mixer for pureeing, beating, chopping up, shaking and mixing, consisting of base, mixing cup and lid with drinking aperture
 - "Mix & Go" – Mix your favorite shake in a few minutes. With the practical drinking aperture, you can take your freshly prepared shake with you to work, school or sports
 - Ideal for preparing fruit and fitness drinks, milk shakes, cocktails, soups, salsa sauces, baby food
 - Incl. recipe suggestions
 - Incl. lid with drinking aperture
 - Ideal for kitchen, bar and on the road
 - Powerful motor, 250 W
 - 1 speed (pulse function)
 - Detachable mixing container (600 ml)
 - Stainless steel blade (rustproof)
 - Safety circuit – operation only possible with vessel in place
 - All accessories dishwasher safe
 - High stability due to rubberized suction pads
- 220–240 V, 50 Hz, 250 W
■ WxHxD approx. 130 x 370 x 125 mm



Replacement bottle for Smoothie maker

● Art. no. 264 559
EAN 4 006 160 645 590 VE 6

● Art. no. 603 862
EAN 4 004 470 038 620 PU 6
● Art. no. 603 866
EAN 4 004 470 038 668 PU 6



4 004470 038620

Citrus fruit squeezer ZP 1092 CB

- Removable bowl with aroma protective cover (1.2 litre)
 - 2 press cones
 - Automatic start/stop function by pressing juicer cone
 - Automatic clockwise/anticlockwise operation for optimal juice extraction
 - Practical cable tidy
- 230 V, 50 Hz, 40 W
■ WxHxD approx. 180 x 230 x 180 mm

● Art. no. 610 920
EAN 4 004 470 109 207 PU 6



4 004470 109207



Stainless steel

32

Automatic juicer
AE 1028 CB

- Powerful 400 watt max.
- Fresh fruit and vegetable juices quickly prepared. Rich in vital substances for well-being, fitness and health
- 30% more juice and vitamins
- Removable pulp container
- Removable juice container
- On/off switch
- Lock with safety switch
- Stainless steel micro-strainer for finest juices
- Can be completely taken apart for rapid and unproblematic cleaning
- High stability due to rubberized suction pads

- 220–240 V, 50 Hz, 350–400 W max.
- WxHxD approx. 235 x 330 x 210 mm

Professional automatic juicer
AE 1917 CB

- Professional automatic juicer in high-quality stainless steel housing
- Fresh fruit and vegetable juices quickly prepared. Rich in vital substances for well-being, fitness and health
- 30 % more juice and vitamins
- Extra large filler spout (75 mm Ø)
- Extracts the juice from apples, carrots and other fruits within seconds without having to chop them
- Powerful 1000 watt motor max.
- 3 speed levels (0-1-2) for different fruit hardness
- High volume pulp container (approx. 2.0 litre capacity)
- Open stainless steel juice spout
- Drip-stop – no splashes and no wiping
- Lock with safety switch
- Stainless steel sieve for finest juices
- Can be completely disassembled – quick and easy cleaning
- High stability due to rubberized suction pads

- 230 V, 50 Hz, 1000 W max.
- WxHxD approx. 300 x 400 x 220 mm



Extra large filler spout (75 mm Ø)



Drip-stop – no splashes and no wiping

Art. no. 610 280
EAN 4 004 470 102 802 PU 4



Art. no. 619 171
EAN 4 004 470 191 714 PU 2





Stainless steel

Automatic juicer
AE 1918 CB

Glass kitchen scale
KW 1515 CB

- Professional automatic juicer in high-quality stainless steel housing
 - Fresh fruit and vegetable juices quickly prepared. Rich in vital substances for well-being, fitness and health
 - 30 % more juice and vitamins
 - Large filler spout (65 mm Ø)
 - 3 speed levels (0-1-2) for different fruit hardness
 - Pulp container (approx. 1.5 litre capacity)
 - Open juice spout
 - Drip-stop due to a folding juice spout
 - Lock with safety switch
 - Stainless steel sieve for finest juices
 - Can be completely disassembled – quick and easy cleaning
 - High stability due to rubberized suction pads
- 220–240 V, 50/60 Hz, 400 W max.
■ W x H x D approx. 272 x 295 x 171 mm

- Extra-flat digital kitchen scale
 - Weighing surface made of high-quality glass
 - Clearly legible LCD display
 - Weights up to 5 kg (1 g scaling)
 - Adjustable measuring units: g, lb-oz, ml, fl-oz
 - Automatic shutdown increases battery life
 - On/off switch
 - Tare function (additive weighed function)
 - High stability due to rubberized feet
 - Low battery indication
- Battery-operated: 1 x CR 2032 (battery supplied)
■ W x H x D approx. 150 x 17 x 220 mm



Large filler spout (65 mm Ø)



Drip-stop due to a folding juice spout



Can also be combined as a suitable kitchen set

Art. no. 619 181
EAN 4 004 470 191 813 PU 4



Art. no. 615 151
EAN 4 004 470 637 304 PU 6
Art. no. 615 155
EAN 4 004 470 151 558 PU 6
Art. no. 615 156
EAN 4 004 470 151 565 PU 6





Stainless steel

34

Kitchen scale KW 1421 CB

- Extra-flat digital kitchen scales with permanent clock and temperature information
- Stainless steel weighing surface
- Clearly legible, high-quality multifunction LCD display
- Weights up to 5 kg (1 g scaling)
- Adjustable measuring units: kg, g, lb, oz
- Automatic shutdown increases battery life
- On/off switch
- Tare function (additive weighed function)
- Battery-operated: 3 x AAA (batteries supplied)
- WxHxD approx. 160 x 18 x 230 mm

Bag sealer FS 1014 CB

- Ideal for dividing food into portions
- Electronically controlled bag sealer
- Seals and separates in one operation
- Strong extraction pump
- With bag storage view window
- 2 indicator lights
- Cord storage in base
- Incl. a roll of film (3 m)
- 220–240 V, 50/60 Hz, 100 W
- WxHxD approx. 330 x 80 x 125 mm

Spare rolls:

Art. no. 8900216

EAN 4 006 160 900 217 PU 10



Art. no. 614 211
EAN 4 004 470 142 112 PU 6



4 004470 142112



Art. no. 610 140
EAN 4 004 470 101 409 PU 6



4 004470 101409



2in1



Fondue deep fat pan
FFR 1290 CB

- Cool touch housing
- Capacity: 1 litre oil/frying fat
- Deep frying basket with removable handle
- Continuously variable thermostat
- Control panel with display
- 6 fondue forks marked in colour
- Protective ring against spray/fork holder
- Changeable odour and fumes filter
- Overheating protection

- 220–240 V, 50 Hz, 840 W
- WxHxD approx. 190 x 240 x 190 mm

Deep fat fryer
FR 2223 CB

- Cool touch housing
- Capacity: approx. 2 litre oil/frying fat
- Oil container with non-stick coating
- Large frying basket, can be raised and lowered with the lid closed
- Pop-up lid with viewing window (detachable)
- On/off switch (0-1)
- Continuously adjustable thermostat with indicator light (130°C–190°C)
- 2 indicator lights for power and heating
- Changeable odour and fumes filter
- Collecting container for condensation
- 2 recessed grips for safe transport

- 230 V, 50 Hz, 1800 W
- WxHxD approx. 245 x 260 x 320 mm



Art. no. 612 900
EAN 4 004 470 129 007 PU 4



Art. no. 622 230
EAN 4 004 470 222 302 PU 2





 **Stainless steel**

Stainless steel deep fat fryer
FR 2264 CB

Hot air fryer
FR 6001 H CB

- Housing, lid, heating coil made of stainless steel
 - Cool zone technology – heating coils immersed directly in the oil for rapid heating and for odorless frying
 - Capacity: 3 litre of oil/frying fat
 - Continuously adjustable thermostat with indicator light
 - Removable fat container (enamelled)
 - Stainless steel heating coil (removable)
 - Drip tray
 - Carrying handles (heat-insulated)
 - Cord storage
 - Overheating protection
- 230 V, 50 Hz, 2000 W
■ WxHxD approx. 215 x 240 x 405 mm

- Oil and fat free hot air fryer
 - Low smoke or odors
 - Time and energy-saving cooking
 - Cool touch handle
 - Capacity: 1.5 litre
 - Removable container (non-stick coated) with safety switch
 - Continuously adjustable thermostat (80°C–200°C)
 - 30 minute timer with shut-off signal
 - Indicator light
 - Overheating protection
- 220–240 V, 50/60 Hz, 900 W
■ WxHxD approx. 225 x 305 x 270 mm

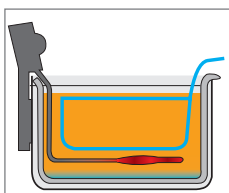

Oil and fat free frying by hot air circulation



Capacity: 1.5 litre

● Art. no. 622 641
EAN 4 004 470 226 416 PU 2



● Art. no. 660 011
EAN 4 004 470 600 117 PU 2





XL – 3.6 litre

Hot air fryer
FR 2301 H CB

- Oil and fat free hot air fryer
- Low smoke or odors
- Time and energy-saving cooking
- Cool touch handle
- Stainless steel inserts
- Capacity: 2.2 litre
- Removable container (non-stick coated) with safety switch
- Continuously adjustable thermostat (80°C–200°C)
- 60 minute timer with shut-off signal
- 2 indicator lights for temperature/operation
- Overheating protection

- 220–240 V, 50/60 Hz, 1500 W
- W x H x D approx. 265 x 335 x 315 mm

Hot air fryer
FR 6002 H CB

- Oil and fat free hot air fryer
- Low smoke or odors
- Time and energy-saving cooking
- Cool touch handle
- Capacity: 3.6 litre
- Non-stick coated container
- Continuously adjustable thermostat (80°C–200°C)
- 30 minute timer with shut-off signal
- 2 indicator lights for temperature/operation
- Overheating protection

- 220–240 V, 50/60 Hz, 900 W
- W x H x D approx. 265 x 320 x 340 mm



Oil and fat free frying by hot air circulation



Capacity: 2.2 litre



Oil and fat free frying by hot air circulation



Capacity: 3.6 litre

Art. no. 623 019
EAN 4 004 470 230 116 PU 2



Art. no. 660 021
EAN 4 004 470 600 216 PU 2





Jam/marmalade
program



Wholemeal
program



Hot dog maker
& egg boiler



38

Bread maker CB 594

- Fully automatic dough and bread preparation (kneading, rising, baking)
 - Non-stick coated baking form (removable)
 - 3 litre capacity (corresponds to about 1300 g bread)
 - 9 baking programs / 31 available settings
 - Programs: Normal, french, whole wheat, sweet, dough, cake, sandwich, baking, fast baking
 - Marmalade program
 - Warming function
 - Electronic control panel with LCD display and audible signal
 - 13 hour timer
 - Variably setttable dough quantity
 - Variable crust browning control (light, medium, dark)
 - Cool touch housing
 - Lid with viewing window
 - 2 kneading pegs
 - Accessories: measuring beaker and spoon
- 230 V, 50 Hz, 800 W
 - W x H x D approx. 400 x 290 x 260 mm

Hot dog maker HDM 462 EK CB N

- Hot dog maker and egg boiler in one
 - For 1 to 14 small sausages (e. g. "Frankfurter", "Vienna sausages")
 - Heated stainless steel skewer
 - Preparation of up to 6 eggs
 - Removable egg holder
 - Transparent steam tank (removable)
 - Non-stick coated water bowl
 - 2 separate switches for spike and steamer (blue illuminated)
 - Incl. measuring cup with egg pricker
- 230 V, 50 Hz, 380 W
 - W x H x D approx. 235 x 270 x 160 mm



Art. no. 605 940
EAN 4 004 470 059 403 PU 2



4 004470 059403

Art. no. 604 620
EAN 4 004 470 046 205 PU 6



4 004470 046205



Stainless steel



Contact grill KG 2242 CB

- Contact grill for double-sided, fat-free grilling
 - Fat drainage channel and drip tray (tray removable for easy cleaning)
 - 2000 watts
 - Stainless steel housing
 - Continuously adjustable thermostat
 - Short cooking times
 - Non-stick grill plates with extra deep grooves for strong grill pattern and smooth fat drainage
 - Large, heat-insulated handle
 - 2 indicator lights for power supply and heating
 - Temperature "ready" display
 - Large grill area: approx. 29.5 x 23.5 cm
 - Cord storage
 - Versatile, can be used for e.g. panini, steaks, fish or vegetables
- 220–240 V, 50/60 Hz, 2000 W
 - W x H x D approx. 335 x 145 x 335 mm



Stainless steel housing

Raclette grill RG 2247 CB

- Cool touch housing
 - For grilling and browning
 - Removable grill plate
 - 8 pans
 - 8 wooden spatulas
 - Continuously adjustable thermostat
 - Indicator light
 - Non-stick coating on the grill plates and pans (easy to clean)
 - Grill area: approx. 40.5 x 30 cm
 - Safe base due to rubberized feet
- 220–240 V, 50/60 Hz, 1200–1400 W
 - W x H x D ca. 430 x 130 x 340 mm



8 wooden spatulas

Art. no. 622 421
EAN 4 004 470 224 214 PU 3



Art. no. 622 471
EAN 4 004 470 224 719 PU 3





2 in 1 Raclette grill RG 2279 CB

- Cool touch housing
- For grilling and browning
- Turning iron plate – Combination grill area for grilling fish (smooth surface) or meat (extra deep grooves for an intense grill pattern)
- Natural grill stone for a healthy, low-fat grilling
- Total grill area: ca. 46 x 23 cm (2x ca. 23 x 23 cm)
- 8 pans, 8 wooden spatula
- Continuously adjustable thermostat (blue illuminated)
- Non-stick coating on the grill plates and pans (easy to clean)
- 220–240 V, 50/60 Hz, 1200–1400 W
- W x H x D approx. 465 x 150 x 235 mm



Natural grill stone for a healthy, low-fat grilling



Continuously adjustable thermostat (illuminated in blue)



Combination grill area for grilling fish or meat (turning iron plate)



Barbecue standing grill BQS 2244 CB

- Stand grill in an attractive design with low smoke emission and low smell
- Continuously adjustable thermostat with indicator light
- Chromed grill grid
- Removable grill and heating elements for easy cleaning
- Cool touch housing
- Metal drip tray
- Wind protection (removable)
- Additional tray
- Can be converted to a table grill
- Grill height: approx. 80 cm
- Grilling surface: 35.5 x 24.5 cm
- 230 V, 50 Hz, 2000 W
- W x H x D approx. 510 x 820 x 370 mm

Art. no. 622 791
EAN 4 004 470 227 918 PU 2



4 004470 227918

Art. no. 622 441
EAN 4 004 470 224 412 PU 4



4 004470 224412



Barbecue table grill BQ 2243 CB

- Table grill in an attractive design with low smoke emission and low smell
- Continuously adjustable thermostat with indicator light
- Chromed grill grid
- Removable grill and heating elements for easy cleaning
- Cool touch housing
- Metal drip tray
- Wind protection
- Grilling surface: 36 x 25 cm
- 230 V, 50 Hz, 2000 W
- WxHxD approx. 510 x 145 x 370 mm

Barbecue table grill BQ 1240 CB N

- Table grill in an attractive design without fire and smoke
- Cool touch housing
- On/off switch with indicator lamp
- Removable grill and heating elements for easy cleaning
- Metal drip tray
- Grilling surface: 35.5 x 24.5 cm
- 230 V, 50 Hz, 2000 W
- WxHxD approx. 480 x 100 x 360 mm

Art. no. 622 431
EAN 4 004 470 224 313 PU 4



4 004470 224313

Art. no. 612 401
EAN 4 004 470 124 019 PU 4



4 004470 124019



3in1

Doner, chicken and shashlik grill



Convection oven
HLO 2280 CB

Doner vertical multigrill
DVG 3006 CB

- Gentle cooking by circulating hot air, low-fat and vitamin-preserving
 - Many different uses for baking, roasting, grilling, steaming, braising, defrosting, heating, barbecuing (easy to use)
 - Halogen heating element for faster heating
 - Saves time and energy: requires up to 45 % less energy than a conventional oven
 - Ideal for small kitchens and mobile use
 - Continuously adjustable thermostat from 0–200°C
 - 12 litre interior
 - Glass bowl: Ø 33 cm
 - Container made of safety glass – heat and scratch-resistant (dishwasher-safe)
 - 60 minute timer with alarm when cooking is completed
 - Indicator lights for operation and temperature
 - Safety switch, practical safety handle
 - Heat-insulated carrying handles
 - Accessories: upper and lower grid, steamer insert, tongs, skewers, lid holder
- 220–240 V, 50/60 Hz, 1200–1400 W
- WxHxD approx. 380 x 335 x 355 mm

- Vertical Kebab Multigrill for fat-free grilling of chickens, kebab/gyros or meat skewers
 - Thanks to its vertical position, escaping jus drips directly into the stainless steel fat tray
 - Incl. 1 rotary spit (large) for chickens or kebab/gyros
 - Incl. 6 separately rotating meat skewers (small)
 - Incl. stainless steel tong
 - On/off switch
 - Indicator light
- 220–240 V, 50/60 Hz, 1400 W
- WxHxD approx. 255 x 350 x 255 mm



Lower/upper grid



Steamer insert



1 rotary spit (large) for chickens or kebab/gyros



6 separately rotating meat skewers (small)



Art. no. 622 800
EAN 4 004 470 228 007 PU 1



4 004470 228007

Art. no. 630 061
EAN 4 004 470 300 611 PU 2



4 004470 300611



4in1

Convection

Pizza stone

Multi pizza oven MPO 2246 CB

- Pizza oven ideal for grilling and crisping up
- Large grill, ideal for pizza (26 x 25 cm)
- Including baking tray (23.5 x 22 cm)
- Capacity: approx. 12 litre
- Top and bottom heat (combined operation possible)
- 4-step switch (top heat, bottom heat, top and bottom heat combined, off)
- 2 quartz heating elements
- 60 minute timer with end signal
- Stainless steel handle
- Crumb tray
- Overheating protection
- 220–240 V, 50/60 Hz, 1000 W
- W x H x D approx. 375 x 220 x 330 mm

NEW! Multi oven MBG 6023 CB

- 30 litres oven capacity
- Convection
- Top and bottom heat, can be used in combination
- Rotisserie
- Incl. pizza stone (Ø 29 cm)
- 90 minute timer with end signal
- 6-setting switch
 - Top and bottom heat
 - Top and bottom heat + convection
 - Top heat + convection
 - Top heat + rotisserie
 - Top and bottom heat + rotisserie + convection
 - Off
- Stepless temperature control (100 °C–230 °C)
- Control lamp
- Removable crumb tray
- Incl. grill rack, baking tray, rotisserie spit, pizza stone (Ø 29 cm)
- Incl. tongs for removal of grill and baking tray, tool for removal of the rotisserie spit
- Large inspection window
- 220–240 V, 50/60 Hz, 1500 W
- W x H x D approx. 510 x 330 x 410 mm

43



Incl. baking tray (23.5 x 22 cm)



Revolving spit



Pizza stone

Art. no. 622 461
EAN 4 004 470 224 610 PU 4



4 004470 224610

Art. no. 660 231
EAN 4 004 470 602 319 PU 4



4 004470 602319



NEW! Microwave
MW 6014 CB

- 700 watt microwave
- 20 litre oven capacity
- 6 level
- Rotating plate, Ø approx. 24.5 cm
- 30 minute timer with end signal
- Oven light
- Large viewing window

- 230 V, 50 Hz, 1150 W
- WxHxD approx. 450 x 255 x 340 mm

NEW! Microwave with grill
MWG 6015 CB

- 700 watt microwave
- 800 watt grill
- 20 litre oven capacity
- 5 microwave power level
- 3 level in combined operation grill/microwave
- 1 grill level
- Rotating plate, Ø approx. 24.5 cm
- Cooking grid: Ø approx. 21.0 cm
- 30 minute timer with end signal
- Oven light
- Large viewing window

- 230 V, 50 Hz, 1150 W
- WxHxD approx. 450 x 255 x 340 mm

● Art. no. 660 142
 EAN 4 004 470 601 428 PU 1
 ● Art. no. 660 141
 EAN 4 004 470 601 411 PU 1



● Art. no. 660 152
 EAN 4 004 470 601 527 PU 1
 ● Art. no. 660 151
 EAN 4 004 470 601 510 PU 1





2in1



ELECTRONIC

2in1

NEW! Microwave with grill
MWG 6016 CB

- 700 watt microwave
 - 800 watt grill
 - 20 litre capacity
 - 5 microwave power level
 - 2 level in combined operation grill/microwave
 - 1 grill level
 - 9 automatic programs incl. defrost program
 - Quick start program
 - Timer function with up to 24 h time delay
 - Rotating plate: Ø approx. 24.5 cm
 - Grilling grid: Ø approx. 21.0 cm
 - 60 minute timer with end signal
 - Easy Tronic
 - Multifunction display incl. digital clock
 - Child lock
 - Oven light
 - Large viewing window
- 230 V, 50 Hz, 1150 W
 - WxHxD approx. 450 x 255 x 340 mm

Microwave with grill
MWG 2289 CB

- 700 watt microwave
 - 900 watt grill
 - 20 litre oven capacity
 - 5 microwave power level
 - 3 levels in combined operation (grill/microwave)
 - 1 grill level
 - Rotating plate: Ø approx. 24.5 cm
 - Cooking grid: Ø approx. 20.0 cm
 - 30 minute timer with end signal
 - Oven light
 - Large viewing window
- 230–240 V, 50 Hz, 1200 W
 - WxHxD approx. 455 x 265 x 340 mm

45



Multifunction display
incl. digital clock

Art. no. 660 161

EAN 4 004 470 601 619

PU 1



4 004470 601619

Art. no. 622 899

EAN 4 004 470 228 991

PU 1



4 004470 228991

**3in1****Convection****Stand-alone/
Under-cabinet mounting**

Microwave with grill and convection MWG 2285 H CB

- Stainless steel front
 - 800 watt microwave power
 - 1350 watt grill
 - 1350 watt convection
 - Quick-start program
 - 20 litre capacity
 - 11 microwave power level
 - 2 level in combined operation (grill/microwave)
 - 4 level in combined operation (convection/microwave)
 - 1 grill level
 - 10 temperature settings for convection
 - 9 automatic programs incl. defrost program
 - Rotating plate, Ø approx. 24.5 cm
 - Grilling grid, Ø approx. 20.0 cm
 - 95 minute timer with end signal
 - Quartz heating elements
 - Digital clock
 - Child lock
 - Oven light
- 230–240 V, 50 Hz, 1200 W
 - WxHxD approx. 455 x 262 x 375 mm

Combined microwave oven with grill MWG 2211 U CB

- Stainless steel front
 - 800 watt microwave
 - 1000 watt grill
 - 20 litre capacity
 - 5 microwave power level
 - 2 level in combined operation
 - 1 grill level
 - 8 automatic programs
 - Defrost programs, selectable according to time and weight
 - Quick-start program
 - Rotating plate, Ø approx. 24.5 cm
 - Grilling grid, Ø approx. 21.0 cm
 - 95 minute timer with end signal
 - Easy Tronic, digital clock, child lock
 - Oven light
 - Large viewing window
 - Can be positioned as required or used as a built-under appliance (incl. installation material)
- 230 V, 50 Hz, 1250 W
 - WxHxD approx. 460 x 285 x 370 mm



Built-under appliance

Art. no. 622 851
EAN 4 004 470 228 519 PU 1



4 004470 228519

Art. no. 622 111
EAN 4 004 470 221 114 PU 1



4 004470 221114

2in1



Built-in microwave with grill
MWG 2215 EB

- Built-in microwave with frame
- Stainless steel front, stainless steel interior
- 800 watt microwave
- 1000 watt grill
- 5 microwave power level
- 2 level in combined operation (grill/microwave)
- 1 grill level
- 8 automatic programs
- Defrost programs, selectable according to time and weight
- 20 litre capacity
- Rotating plate, Ø approx. 24.5 cm, grilling grid, Ø approx. 21 cm
- 95 minute timer with end signal
- Start delay
- Child lock
- Oven light

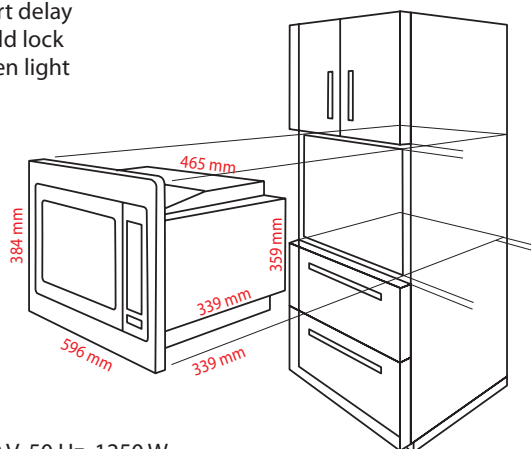

- 230 V, 50 Hz, 1250 W
- Appliance (WxHxD): 465 x 359 x 339 mm
- Appliance with frame (WxHxD): 596 x 384 x 339 mm
- Weight: approx. 14 kg

3in1



Built-in microwave with grill and convection
MWG 2216 H EB

- Built-in microwave with frame
- Stainless steel front, stainless steel interior
- 900 watt microwave
- 1100 watt grill
- 2500 watt convection function
- 5 microwave power level
- 2 level in combined operation (grill/microwave)
- 2 level in combined operation (convection/microwave)
- 1 grill level
- 10 temperature settings for convection (130°C–220°C)
- 10 automatic programs
- 2 defrost programs, 1 quick-start program
- 25 litre capacity
- Rotating plate, Ø approx. 32.0 cm, grilling grid, Ø approx. 26.0 cm
- 95 minute timer with end signal
- Start delay
- Child lock
- Oven light

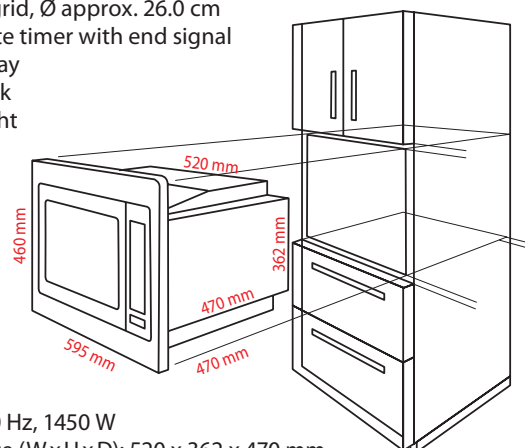

- 230 V, 50 Hz, 1450 W
- Appliance (WxHxD): 520 x 362 x 470 mm
- Appliance with frame (WxHxD): 595 x 460 x 470 mm
- Weight: approx. 21 kg

Art. no. 622 151
EAN 4 004 470 221 510 PU 1



Art. no. 622 161
EAN 4 004 470 221 619 PU 1



3in1



Built-in microwave with grill and convection MWG 3001 H EB

- Built-in microwave in frameless design
- Stainless steel front, stainless steel interior
- LCD display
- Digital clock
- 900 watt microwave
- 1300 watt grill
- 2300 watt convection function
- 5 microwave power level
- 2 level in combined operation (grill/microwave)
- 2 level in combined operation (convection/microwave)
- 1 grill level
- 5 temperature settings for convection (100°C–200°C)
- 8 automatic programs
- Defrost program, quick-start program
- Timer function with up to 24 h time delay
- 25 litre capacity
- Rotating plate, Ø approx. 27.0 cm, grilling grid, Ø approx. 22.2 cm
- 60 minute timer with end signal
- Child lock
- Oven light

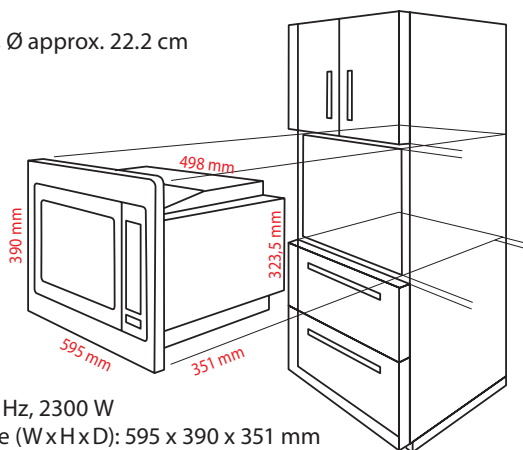

- 230 V, 50 Hz, 2300 W
- Appliance (W x H x D): 595 x 390 x 351 mm
- Weight: approx. 17 kg

Art. no. 630 011
EAN 4 004 470 300 116 PU 1





 Stainless steel

Stainless steel double hotplate DKP 5033 E CB

- Stainless steel housing
- 2 hotplates
 - 1 x Ø approx. 180 mm, 1500 watt
 - 1 x Ø approx. 150 mm, 1000 watt
- 2 continuously variable thermostats
- 2 indicator lights
- Incl. 2 mountable cool touch handles
- High stability

- 230 V, 50 Hz, 2500 W
- WxHxD approx. 590 x 70 x 280 mm (with handles)

Single hotplate EKP 5027 CB

- Hotplate, Ø approx. 180 mm, 1500 watt
- Infinitely adjustable thermostat
- Indicator light
- Heat-resistant finish
- High stability

- 230 V, 50 Hz, 1500 W
- WxHxD approx. 360 x 70 x 285 mm

Art. no. 650 331
EAN 4 004 470 503 319 PU 3



Art. no. 650 270
EAN 4 004 470 502 701 PU 4





50

Double hotplate DKP 5028 CB

- 2 hotplates
 - 1 x Ø approx. 180 mm, 1500 watt
 - 1 x Ø approx. 150 mm, 1000 watt
- 2 continuously variable thermostats
- 2 indicator lights
- Heat-resistant finish
- High stability

- 230 V, 50 Hz, 2500 W
- WxHxD approx. 570 x 70 x 285 mm

Single induction hotplate EKI 5014 CB

- Induction hotplate with high-quality, eco-friendly Schott-Ceran® glass-ceramic surface
- Heating only takes seconds thanks to induction technology
- Scratch-resistant smooth cooking area, very easy to clean
- ECO-Save – 55 % time savings compared to conventional cooking plates, no preheating phase, energy-saving
- Automatic pot detection – automatic switch-off in the case of non-induction pots
- 10 power level and 10 temperature level
- Electronic control panel with display
- Easy to handle because of oversized buttons
- Power indication on LED display
- 180 minute timer with automatic switch-off and end signal
- Automatic switch-off after 120 min. without operation
- Automatic switch-off 15 sec. after removal of the pot
- 7 LED indicator lights
- High stability due to non-slip feet

- 230 V, 50 Hz, 2000 W
- WxHxD approx. 280 x 65 x 360 mm

Art. no. 650 280
EAN 4 004 470 502 800 PU 3



4 004470 502800

Art. no. 650 141
EAN 4 004 470 501 414 PU 2



4 004470 501414

MC 701 CB



MC 702 CB



Textile cleaner

MC 701 CB / MC 702 CB

51

MC 701 CB

- Ideal for the easy removal of lint/pilling
- Handy size
- Metal lint grid
- Transparent lint container
- On/off switch
- Battery operation: 2x 1.5 V (AA) (batteries not included)
- WxHxD approx. 36 x 76 x 76 mm

MC 702 CB

- Ideal for the easy removal of lint/pilling
- Handy size
- Metal lint grid
- Transparent lint container
- On/off switch
- Battery operation: 2x 1.5 V (AA) (batteries not included)
- WxHxD approx. 60 x 85 x 170 mm

 Art. no. 607 010 (MC 701 CB)
 EAN 4 004 470 070 101 PU 20
 Art. no. 607 020 (MC 702 CB)
 EAN 4 004 470 070 200 PU 20





52

Steam iron DB 6003 CB

- Special stainless steel soleplate
- 7 functions:
 - Spray device
 - Steam jet function
 - Vertical steam
 - Dry function (steam can be switched off)
 - Self-cleaning function (switchable)
 - Anti-drip function
 - Anti-calc filter system
- Variable temperature control
- Uniform heat distribution through 23 steam nozzles
- 3-level steam control (0-1-2)
- Incl. switchable self-cleaning function
- Transparent water container (approx. 160 ml)
- Cable attached via 360° turnable joint
- Indicator light
- Accessories: measuring cup
- 220–240 V, 50/60 Hz, 1800 W max.
- WxHxD approx. 110 x 140 x 265 mm



Incl. switchable self-cleaning function

Steam iron DB 6004 CB

- Special stainless steel soleplate
- 7 functions:
 - Spray device
 - Steam jet function
 - Vertical steam
 - Dry function (steam can be switched off)
 - Self-cleaning function (switchable)
 - Anti-drip function
 - Anti-calc filter system
- Variable temperature control
- Uniform heat distribution through 34 steam nozzles
- 3-level steam control (0-1-2)
- Transparent water container (approx. 250 ml)
- Cable attached via 360° turnable joint
- Indicator light
- Accessories: measuring cup
- 220–240 V, 50/60 Hz, 2200 W max.
- WxHxD approx. 110 x 140 x 285 mm



Incl. switchable self-cleaning function

Steam iron DB 784 CB

- Special stainless steel soleplate
- 7 functions:
 - Spray device
 - Steam jet function
 - Vertical steam
 - Dry function (steam can be switched off)
 - Self-cleaning function (switchable)
 - Anti-drip function
 - Anti-calc system
- Variable temperature control
- Continuous steam regulation
- Transparent water container (approx. 360 ml)
- Cable attached via 360° turnable joint
- Indicator light
- 220–240 V, 50/60 Hz, 2500 W
- WxHxD approx. 115 x 150 x 290 mm



Incl. switchable self-cleaning function

Art. no. 660 031
EAN 4 004 470 600 315 PU 6



4 004470 600315

Art. no. 660 041
EAN 4 004 470 600 414 PU 6



4 004470 600414

Art. no. 607 841
EAN 4 004 470 078 411 PU 6



4 004470 078411



Ceramic

Ceramic

Cordless

Steam iron
DB 6005 CB

Cordless steam iron
DB 6006 CB

- Scratch-resistant ceramic sole plate with outstanding sliding behaviour
 - 7 functions:
 - Spray device
 - Steam jet function
 - Vertical steam
 - Dry function (steam can be switched off)
 - Self-cleaning function (switchable)
 - Anti-drip function
 - Anti-calc filter system
 - Variable temperature control
 - Uniform heat distribution through 40 steam nozzles
 - 4-level steam control (0-1-2-3)
 - Transparent water container (approx. 350 ml)
 - Soft touch controls
 - Rubberized handle for non-slip handling
 - Cable attached via 360° turnable joint
 - Indicator light
 - Accessories: measuring cup
- 220–240 V, 50/60 Hz, 2600 W max.
 ■ W x H x D approx. 125 x 145 x 300 mm

- Scratch-resistant ceramic sole plate with outstanding sliding behaviour
 - Cordless – ironing without interfering cable
 - 7 functions:
 - Spray device
 - Steam jet function
 - Vertical steam
 - Dry function (steam can be switched off)
 - Self-cleaning function (switchable)
 - Anti-drip function
 - Anti-calc filter system
 - Variable temperature control
 - Uniform heat distribution through 56 steam nozzles
 - 4-level steam control (0-1-2-3)
 - Transparent water container (approx. 350 ml)
 - High stability due to rubberized feet
 - Flexible cable routing
 - Indicator light
- 220–240 V, 50/60 Hz, 2400 W max.
 ■ W x H x D approx. 145 x 175 x 340 mm



Easy-running, scratch-resistant ceramic soleplate



Incl. switchable self-cleaning function



Easy-running, scratch-resistant ceramic soleplate



Incl. switchable self-cleaning function



2 in 1 – also to use cordless

Art. no. 660 051
EAN 4 004 470 600 513 PU 6



4 004470 600513

Art. no. 660 061
EAN 4 004 470 600 520 PU 4



4 004470 600520



2300 Watt

NEW! Steam ironing station
DBS 6018 CB

- Special stainless steel soleplate
 - 3.5 bar steam pressure with constant high steam output (max. 90 g/min.)
 - Even heat distribution through 11 steam nozzles
 - Horizontal and vertical steam function
 - Removable water tank (1.2 litre capacity), in case of average operation sufficient for up to 80 minutes
 - Electronic anti-drip system
 - Indicator light
 - Continuous temperature control
 - Incl. 3 anti-scale cartridges
 - Extra large rest plate to provide the iron with a stable rest
 - Transport safety device (lockable)
 - Extra long connection cable
 - Cord storage compartment
- 220–240 V, 50/60 Hz, 2300 W
 - WxHxD approx. 175 x 265 x 365 mm



Removable water tank
(1.2 litre capacity)



Cord storage
compartment

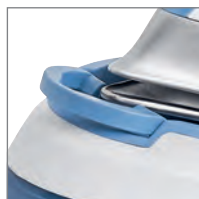

Transport safety device
(lockable)

Art. no. 660 181
EAN 4 004 470 601 817 PU 2



4 004470 601817



2300 Watt

Ceramic

NEW! Steam ironing station
DBS 6019 CB

55

- Scratch-resistant and smooth „Superglide“ ceramic soleplate with outstanding sliding behaviour
 - 3.5 bar steam pressure with constant high steam output (max. 90 g/min.)
 - Even heat distribution through 11 steam nozzles
 - Horizontal and vertical steam function
 - Removable water tank (1.2 litre capacity), in case of average operation sufficient for up to 80 minutes
 - Electronic anti-drip system
 - Indicator light
 - Continuous temperature control
 - Incl. 3 anti-scale cartridges
 - Extra large rest plate to provide the iron with a stable rest
 - Transport safety device (lockable)
 - Extra long connection cable
 - Cord storage compartment
- 220–240 V, 50/60 Hz, 2300 W
 - WxHxD approx. 175 x 265 x 365 mm



Removable water tank
(1.2 litre capacity)



Cord storage
compartment



Transport safety device
(lockable)



Scratch resistant
ceramic sole plate with
outstanding sliding
behaviour

Art. no. 660 191
EAN 4 004 470 601 916 PU 2



4 004470 601916

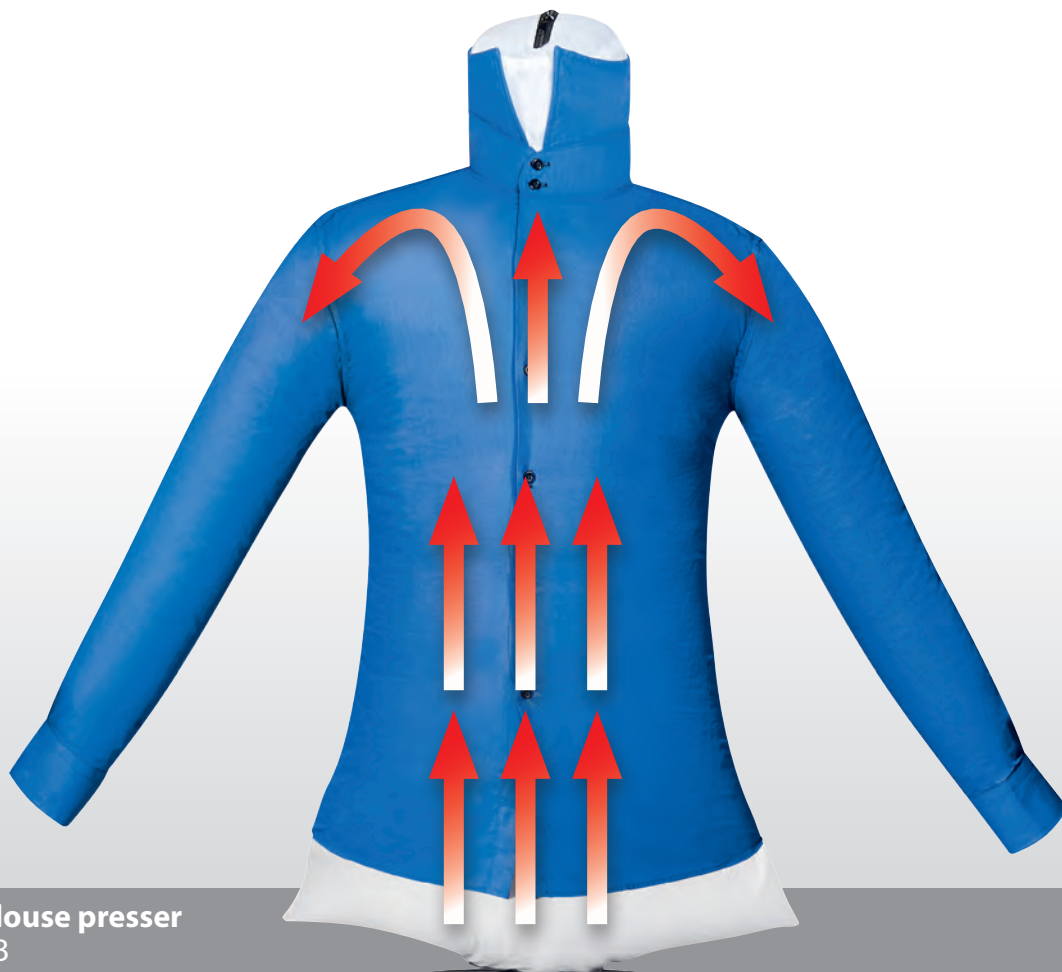

2in1

NEW! Shirt and blouse presser
HBB 6025 CB

- Ironing dummy for crease-free shirts and blouses
- 2 in 1 function – one-step drying and ironing of e.g. outer clothing such as shirts, blouses, T-shirts and pullovers suitable for the dryer
- Time and energy saving – clothes dry and ironed in just a few minutes
- Fully automatic drying and ironing in one – replaces irons and ironing boards
- Also suitable for freshening – neutralizes odors
- „One size“-balloon body (XS – S – M – L – XL – XXL)
- 180 minute timer
- 2 temperature levels (cold/warm)
- Hot air function with maximum 850 Watt

- 230 V, 50 Hz, 850 W
- W x H x D (Base) approx. 270 x 310 x 180 mm
- W x H x D (with doll) approx. 1260 x 1110 x 400 mm



Replacement balloons HBB 6025 CB

Art. no. 263 869
EAN 4 006 160 638 691

PU 1



Incl. 180 minute timer/
2 temperature levels



The washed/tumbled article
of clothing is pulled onto the
balloon body



Set the timer to the necessary
period – the article of clothing is
dried and ironed by the air flow



The dried and ironed article
of clothing is finished and can be
pulled off of the balloon body

Art. no. 660 251
EAN 4 004 470 602 524 PU 1



4 004470 602524



Steam cleaner
DR 906 CB

- Steam cleaner, cleans, disinfects and degreases without limescale residues and cleaning strip
- 3.5 bar max. steam pressure
- Approx. 600 ml water tank
- Aluminum boiler
- Indicator light (mains and standby)
- Safety tank lid with pressure relief valve
- Overheating protection
- On/off switch protected against water spray
- Practical carrying handle
- Smooth-running wheels
- Steam control on the handle
- Incl. 9 accessories: 2-part extendable insertable tube, floor brush, non-woven cloth, window wiper, jet nozzle attachments, round brush attachment, funnel, measuring beaker
- 230 V, 50/60 Hz, 1350 W
- W x H x D approx. 230 x 310 x 320 mm



Extendable insertable tube



Floor brush



Round brush attachment



Window wiper

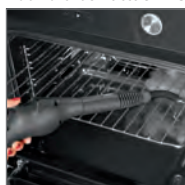

Angle attachment



Battery vacuum cleaner
CB 967

- With 3 rechargeable Ni-Mh batteries
- Nozzle for small gaps, brush nozzle
- Permanent dust filter, washable
- Charge control lamp (LED)
- Charger mains adapter
- Foot/wall mounting (installation materials not supplied)
- Charger mains adapter: 230 V, 50 Hz
- Rechargeable battery: 3.6 V, 1400 mAh
- W x H x D approx. 100 x 130 x 310 mm



Art. no. 609 061
EAN 4 004 470 090 611 PU 1



4 004470 090611

Art. no. 609 670
EAN 4 004 470 096 705 PU 6



4 004470 096705



12 V operation

Battery wet/dry vacuum cleaner
AKS 960 CB

- Wet/dry vacuum cleaner
- Powerful battery vacuum cleaner with three rechargeable batteries
- Permanent dust filter, washable
- Charge indicator light (LED)
- Charger mains adapter
- Accessories: Recess nozzle, attachment for wet vacuuming, wall mounting
- Charger mains adapter: 230 V, 50 Hz
- Rechargeable battery: 3.6 V, 1400 mAh
- WxHxD approx. 110 x 130 x 380 mm

Battery vacuum cleaner
AKS 713 CB

- Wet/dry vacuum cleaner
- Powerful battery vacuum cleaner with 10 rechargeable batteries
- Permanent dust filter (washable)
- Charge control lamp (LED)
- 12 V and battery operation possible
- Direct-Drive function: with fully discharged battery, the vacuum cleaner can be used immediately in 12 V operation
- Cable storage compartment
- Accessories: 2x crevice nozzle (1x 13 cm, 1x 26 cm), attachment for wet vacuuming, brush nozzle, 12 V adapter cable
- Charger mains adapter: 230 V, 50 Hz
- Rechargeable battery: 12 V / Battery (NiMH), 1400 mAh
- WxHxD approx. 125 x 130 x 400 mm

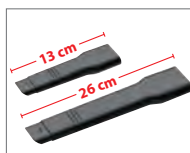

Extra-long crevice nozzles, for example, for use in the car



Attachment for wet vacuuming



360° brush nozzle

Hand vacuum cleaner
CB 947

- Hand vacuum cleaner for vacuuming of: furniture, upholstery, frames, curtains, books, computers, cars, and much more
- Compact size: 24 x 12 x 15 cm
- Permanent dust filter
- Easy to clean
- Large operation range (6 m cable)
- Low weight
- Vertical storage (space saving)
- Accessories: flexible „vacuum snout“ with crevice nozzle, small and large brush, shoulder strap
- 230 V, 50 Hz, 700 W max.
- WxHxD approx. 110 x 185 x 360 mm



Art. no. 609 600
EAN 4 004 470 096 002 PU 6



4 004470 096002

Art. no. 607 139
EAN 4 004 470 071 399 PU 4



4 004470 071399

Art. no. 609 470
EAN 4 004 470 094 701 PU 6



4 004470 094701

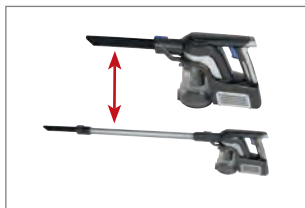

With one click from the vacuum cleaner to the hand vacuum cleaner



Practical wall mount incl. charging station and accessory holder

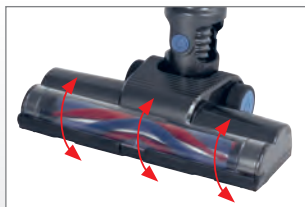

Electrically rotating floor brush



Incl. 3 additional nozzles



NEW! Battery floor vacuum cleaner BS 6027 A CB

- 2 in 1 – High-performance battery floor and hand vacuum cleaner for cordless cleaning
 - Eco-Cyclon twin spin battery hand and vacuum cleaner with 18.5 V lithium ion battery (2200 mAh)
 - Electrically rotating floor brush
 - Incl. extra long crevice nozzle (25 cm)
 - Incl. rotatable brush nozzle (90°)
 - Incl. mini special nozzle
 - Suitable for all surfaces
 - Electronic overcharge protection
 - From floor vacuum cleaner to hand vacuum cleaner with one click, this vacuum is useful for cleaning furniture, cushions, drapes, books, car seats
 - Bagless filter technology – easy emptying at the touch of a button + no need to buy expensive replacement vacuum cleaner bags later
 - HEPA filter (High efficiency particulate air filter)
 - Battery running time approx. 20 minutes
 - Battery charge time approx. 4 hours
 - Aluminium suction pipe
 - Electronic power control (2-step)
 - Integrated economy mode for longer battery life
 - 4-step LED battery level indicator
 - Optimum mobility with the double pivot that can be rotated up to 180°
 - Practical wall mount incl. charging station and accessory holder
 - Accessories: crevice nozzle, brush nozzle, mini special nozzle, wall mount
- 220–240 V, 50/60 Hz, 18.5 V / rechargeable battery (Li-Ion), 2200 mAh
 - W x H x D approx. 335 x 225 x 120 mm

Turbo Rotation

EXTRA SUCKING POWER
through electrically rotating
floor brush



Art. no. 660 271
EAN 4 004 470 602 715 PU 1



4 004470 602715



Incl. electrically rotating turbo floor brush

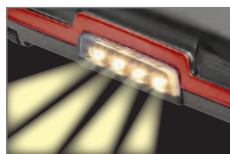

LED front light for better illumination of dark areas



Incl. flexible brush for corners and edges



2-fold accessories: combined brush/crevice nozzle



2in1

Battery floor vacuum cleaner BS 1949 A CB



- Accu-hand and floor vacuum cleaner, for flexible and individual operatings as brush-/hand vacuum cleaner
- Bagless Cyclon Twin Spin technique allows continual high suction power
- Bagless filter technology
- Powerful lithium-ion battery 21,6 V, 2200 mAh accu
- Running time approx. 30 min
- 2 suction levels (turbo function electrically switchable)
- LED battery charge condition indicator (illuminated)
- Cable free (for flexible use)
- HEPA-Filter
- Aluminium suction tube
- Easy to clean
- Low weight
- Charging station suitable for wall mounting (incl. mounting material)
- Incl. electrically rotating turbo floor brush with LED front light for better illumination of dark areas
- Incl. flexible brush for corners and edges
- Accessories: aluminium suction tube, wall mount, special brush, combined brush/crevice nozzle
- Charger mains adapter: 230–240 V, 50 Hz
- Rechargeable battery: 21,6 V, 2200 mAh
- W x H x D approx. 200 x 1050 x 260 mm (with suction tube)



Charging station / wall mount (incl. mounting material)

Powerful Lithium-ion battery 21.6 V / 2200 mAh



Incl. brush tool



Incl. crevice tool



Incl. wall mount



Big operating range (6.5 m connection cable)

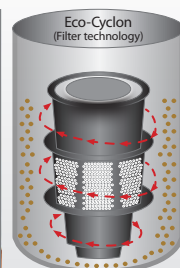

Eco-Cyclon filter technology

2in1



Floor vacuum cleaner BS 1948 CB N

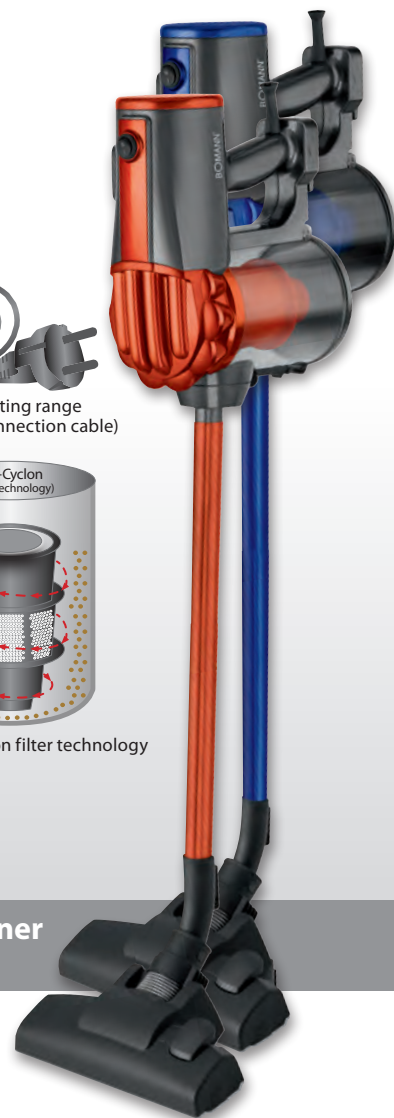

- 2 in 1 – Floor and hand vacuum cleaner
- Eco-Cyclon
- Also suitable as hand vacuum cleaner for vacuuming of: furniture, upholstery, frames, curtains, books, computers, cars and much more
- Multi filter system
- HEPA-Filter
- Two part aluminium tube (40–85 cm)
- Big operating range (6.5 m connection cable)
- Switchable floor brush
- Easy to clean
- Low weight
- Incl. wall mount (space saving)
- Accessories: Two part aluminium tube, wall mount, brush tool, crevice tool, floor brush
- 220–240 V, 50/60 Hz, 600 W
- W x H x D approx. 230 x 1300 x 130 mm (with suction tube)



Incl. floor brush (switchable)

● Art. no. 619 497
 ● EAN 4 004 470 194 975 PU 2
 ● Art. no. 619 496
 ● EAN 4 004 470 194 968 PU 2



● Art. no. 619 489
 ● EAN 4 004 470 194 890 PU 2
 ● Art. no. 619 483
 ● EAN 4 004 470 194 838 PU 2





Floor vacuum cleaner BS 9019 CB N

61

- Floor vacuum cleaner with energy-saving 700 watt
 - 5-layer micro-filter system
 - Stainless steel suction tube
 - Switchable floor brush
 - Dust bag change indicator
 - Practical carrying handle
 - Automatic cable rewind
 - Space-saving parking aid
 - 2-fold accessories: combined brush/crevice nozzle
- 220–240 V, 50/60 Hz, 700 W
 - WxHxD approx. 256 x 205 x 310 mm



Incl. floor brush (switchable)

2-fold accessories: combined
brush/crevice nozzle

 **Art. no. 660 111**
EAN 4 004 470 601 114 **PU 1**
 **Art. no. 690 195**
EAN 4 004 470 901 955 **PU 1**





Floor vacuum cleaner
BS 9027 CB N

- Eco-Cyclon twin spin floor vacuum cleaner with energy-saving 700 Watt
- Bagless Cyclon Twin Spin technique allows continual high suction power
- Electronic power adjustment
- 4-fold filter system
- Stainless steel telescopic tube (approx. 92 cm length)
- Extra-large operation range (approx. 8.30 m)
- Switchable floor brush
- Incl. parquet brush
- Rubberised rollers (ideal for sensitive floors)
- Practical carrying handle
- Automatic cable rewind
- Space-saving parking aid
- Dual accessory: combined brush/crevice nozzle
- 220-240 V, 50/60 Hz, 700 W
- W x H x D approx. 250 x 330 x 380 mm



Incl. parquet brush



Floor vacuum cleaner
BS 3000 CB

- Eco-Cyclon twin spin floor vacuum cleaner with energy-saving 700 Watt
- Bagless filter technology
- 4-fold microfilter system
- HEPA filter (High efficiency particulate air filter)
- Metal telescopic tube
- Switchable floor brush
- Practical carrying handle
- Automatic cable rewind
- Space-saving parking aid
- Dual accessory: combined brush/crevice nozzle
- 220-240 V, 50/60 Hz, 700 W
- W x H x D approx. 340 x 250 x 270 mm

Art. no. 690 277
EAN 4 004 470 902 778 PU 1



4 004470 902778

Art. no. 630 003
EAN 4 004 470 638 219 PU 1
Art. no. 630 002
EAN 4 004 470 638 202 PU 1



4 004470 638219 4 004470 638202



ELECTRONIC

Floor vacuum cleaner BS 9018 CB N

- Floor vacuum cleaner with energy-saving 700 Watt
- Electronic power adjustment
- Includes 2 HEPA filter
- Height-adjustable telescopic tube
- Switchable floor brush
- Bagless filtertechnology (no need to purchase dust bags)
- Easy-to-empty, transparent dust-collecting container replaces conventional dust bag
- Tank volume: 1.25 l
- Motor protection filter (washable)
- Rubberised rollers (ideal for parquet floors)
- Automatic cable rewind
- Space-saving parking aid
- 3-fold accessories: combined brush/crevice nozzle, upholstery nozzle
- 220–240 V, 50/60 Hz, 700 W
- W x H x D approx. 365 x 265 x 285 mm



2in1



Stainless steel

Wet and dry vacuum cleaner BS 9000 CB

- Stainless steel housing
- Large and comfortable wet and dry vacuum cleaner with powerful 1400 watt max.
- Tank capacity: approx. 20 litres
- Multi filter system
- Incl. blower function, e.g. for easy removal of leaves
- Draws coarse dirt as effectively as liquids
- Optimal stability through 4 rollers
- Deflection rollers (360°) allow smooth and flexible working
- 2-part robust suction tube
- Overflow protection by float valve
- Practical holder on the vacuum cleaner for quick access and tidied accessory
- 5 m cable allows large operation range
- Accessories: brush/crevice nozzle, wet/dry brush, washable permanent filter
- 220–240 V, 50/60 Hz, 1200–1400 W
- W x H x D approx. 405 x 530 x 405 mm



Also ideal for the use on laminate, carpets etc.

Accessories:
brush nozzle and crevice nozzle

Art. no. 690 187
EAN 4 004 470 901 870 PU 1



4 004470 901870

Art. no. 690 000
EAN 4 004 470 900 002 PU 1



4 004470 900002

4in1

Dry vacuum cleaning
Wet vacuum cleaning
Shampoo function
Blower function

Stainless steel tube

Accessories-holder



Upholstery nozzle

Shampoo nozzle

Wet/dry brush

Crevice nozzle

Shampoo vacuum cleaner BSS 6000 CB

- Comfortable shampoo vacuum cleaner with powerful 1200 watts
 - Cleans away larger dirt just as effectively as fluids
 - Comes with separate removable tank for cleaning agent (4 litres)
 - Spray extraction for even & large-scale spreading of the cleaning agent
 - Perfect stability thanks to four pulleys
 - 4 pulleys (360°) allow for easy and flexible cleaning
 - 2-piece stainless steel cleaner pipe
 - Big, sturdy carrying handle
 - Dual filter system
 - Practical bracket holder for ready-to-hand and organized accessories
 - Comes with drain appliance to discharge absorbed fluids
 - Blower function, e.g. to remove leaves easily
 - For easy and thorough cleaning of fabrics, areas, and hard floors (e.g. stone, tiles, linoleum)
 - For deep-cleaning of upholstery and rugs
 - Accessories: Crevice nozzle, parquet brush, big suction brush, e.g. to clean carpet floors, tiles; small suction brush, e.g. to clean upholstery
 - Tank volume (wet cleaning operation) 20 litres
 - Cleaning container volume: 4 litres
- 220–240 V, 50/60 Hz, 1200 W
 - W x H x D approx. 370 x 500 x 430 mm

Large tank volume
(approx. 20 litres)Shampoo tank
(approx. 4 litres)

Shampoo cleaner



Wet/dry vacuum cleaner



Upholstery cleaner



Art. no. 660 001

EAN 4 004 470 600 018

PU 1



4 004470 600018



Electronic bathroom scale

PW 1417 CB

- Electronic glass bathroom scale with easy-to-read LCD display
- Weighing units in kg, lb, st (convertible)
- Measurement range of 2.5–150 kg (subdivided into 100 g steps)
- Low-maintenance standing surface
- Non-slip feet ensuring secure base
- Automatic switch-off (prolongs battery life)
- Battery operation: 1x CR 2032 (battery not included)
- W x H x D approx. 330 x 25 x 300 mm



Foot massager

FM 8000 CB

- Intense whirlpool effect
- Massage burls for stimulating the foot reflex zones
- Additional massage roller, detachable, for selective foot reflex zone massage
- Heated footrest
- 4-level switches:
 - 0 = off
 - 1 = massage,
 - 2 = warm/whirl
 - 3 = warm/whirl/massage
- Can be used with and without water
- Splash guard, detachable
- Water level mark
- Spout
- Large rubber feet for slip-proof stand
- 230 V, 50 Hz, 90 W
- W x H x D approx. 300 x 120 x 380 mm



Art. no. 614 171
 EAN 4 004 470 141 719 PU 6



4 004470 141719

Art. no. 680 000
 EAN 4 004 470 800 005 PU 3



4 004470 800005



2in1

66

Nose and ear hair remover NE 8008 CB

- Conveniently and simply removes troublesome hairs in the nose and ears
- Includes light for improved personal grooming
- Removable fine-steel shearing head for cleaning
- On/off switch
- Incl. covering cap for the shearing head
- Battery operation: 1x 1.5 V (AA) (batteries not included)
- WxHxD approx. 30 x 130 x 35 mm



Includes light for improved personal grooming



Promotional Packaging

Hair and beard trimmer HSM 8006 CB

- Stainless steel precision shaving head for uniform haircut
- Stainless steel blade
- Stepless cutting length adjustment for efficient use of the comb attachments
- 4 comb attachments: 3, 6, 9, 12 mm
- Rubberized inlay for non-slip handling
- Accessories:
 - 4 comb attachments
 - Cleaning brush
 - Shearing head protection
 - Hanging loop
- 230–240 V, 50 Hz, 9 W
- WxHxD approx. 65 x 200 x 55 mm



Hair trimmer set HSM 8007 NE CB

- Hair and beard trimmer:**
- Stainless steel precision shaving head for uniform haircut
 - Stainless steel blade
 - Stepless cutting length adjustment for efficient use of the comb attachments
 - 4 comb attachments: 3, 6, 9, 12 mm
 - Soft touch inlay for non-slip handling
 - Accessories: 4 comb attachments, cleaning brush, shearing head protection, comb, hanging loop
 - 230–240 V, 50 Hz, 9 W
 - WxHxD approx. 65 x 200 x 55 mm
- Nose and ear hair remover:**
- Gently and comfortably removes unsightly nose and ear hair
 - Stainless steel shaving head, can be detached for cleaning
 - Incl. cap for shaving head
 - Battery operation: 1x 1.5 V (AA) (batteries not included)
 - WxHxD approx. 30 x 130 x 30 mm



Art. no. 680 080
EAN 4 004 470 800 807 PU 12



4 004470 800807

Art. no. 680 061
EAN 4 004 470 800 616 PU 12



4 004470 800616

Art. no. 680 071
EAN 4 004 470 800 715 PU 10



4 004470 800715



Hot air curling brush HAS 8101 CB

- Hot air styler for even and gentle heat distribution
 - 3 exchangeable brush attachments with smooth bristles for hair gentle styling:
 - 1 volume styler
 - 2 round brushes individual for all hair length and requirements (15 mm Ø and 25 mm Ø)
 - 2 temperature-/power settings
 - Cold setting for style fix and hairstyle finish
 - Ergonomic design handle
 - Cable attached via 360° turnable joint
 - Overheating protection
 - Hanging loop
- 230 V, 50/60 Hz, 600 W
■ WxHxD approx. 365 x 50 x 50 mm

Hair dryer HT 8002 CB

- Compact travelling hair dryer
 - 2 temperature/power settings
 - Removable shaped nozzle, rotatable through 360°
 - Rubber profile on the casing avoid slipping
 - Overheating protection
 - Hanging loop
- 230 V, 50 Hz, 1200 W
■ WxHxD approx. 111 x 210 x 75 mm



Volume styler

1 round brush
(15 mm Ø)1 round brush
(25 mm Ø)

Art. no. 681 011
EAN 4 004 470 810 110 PU 6



Art. no. 680 029
EAN 4 004 470 800 296 PU 12





68

Hair dryer HTD 8005 CB

- Compact travelling hair dryer
 - Folding handle
 - 2 temperature/power settings
 - Removable shaped nozzle, rotatable through 360°
 - Soft touch housing – rubberised surface to prevent slipping when putting down
 - Includes volume diffuser and see-through bag for practical storage and when travelling
 - Switchable voltage: 110/230 V
 - Hanging loop
- 110/230 V, 50/60 Hz, 1100–1200 W
 - WxHxD approx. 170 x 235 x 75 mm

Professional hairstyler HTD 889 CB

- Professional hairstyler with 2000 watt max.
 - 3 temperature/power settings
 - 2 speed settings
 - Cool Shot
 - Professional volume diffuser and shaping nozzle
 - Air intake filter, removable
 - Rubberised housing
 - Avoid slipping
 - Soft-touch grip
 - Overheating protection
 - Hanging loop
- 220–240 V, 50/60 Hz, 1800–2000 W
 - WxHxD approx. 270 x 270 x 90 mm

● Art. no. Nr. 680 056
EAN 4 004 470 800 562 PU 12



4 004470 800562

● Art. no. 608 891
EAN 4 004 470 088 915 PU 6



4 004470 088915



Ø 23 cm

Table fan
VL 1137 CB

- Oscillating (can be switched off)
 - Adjustable angle of inclination
 - Metal protection grid
 - Safe base
 - Ø approx. 23 cm
 - 2 speed level
 - 3-level switches (0-1-2)
 - Practical carrying handle
- 220–240 V, 50/60 Hz, 30 W
■ W x H x D approx. 275 x 375 x 220 mm

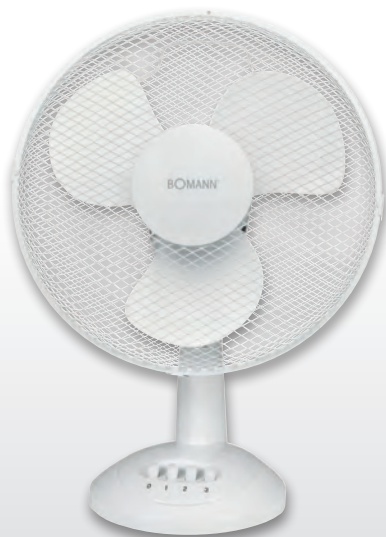

Ø 30 cm

Table fan
VL 1138 CB

- Oscillating (can be switched off)
 - Adjustable angle of inclination
 - Metal protection grid
 - Safe base
 - Ø approx. 30 cm
 - 3 speed level
 - 4-level switches (0-1-2-3)
 - Practical carrying handle
- 220–240 V, 50/60 Hz, 40 W
■ W x H x D approx. 340 x 480 x 245 mm



Ø 40 cm

Standing fan
VL 1139 S CB

- Oscillating (can be switched off)
 - Height-adjustable
 - Adjustable angle of inclination
 - Metal protection grid
 - Safe base
 - Ø approx. 40 cm
 - 3 speed level
 - 4-level switches (0-1-2-3)
 - Practical carrying handle
- 220–240 V, 50/60 Hz, 45 W
■ W x H x D approx. 430 x 1250 x 640 mm

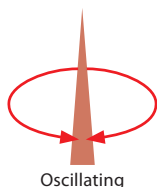

Oscillating

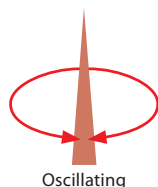

Oscillating

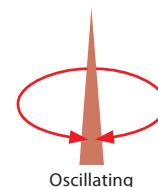

Oscillating

Art. no. 611 370
EAN 4 004 470 611 373 PU 4



4 004470 611373

Art. no. 611 380
EAN 4 004 470 611 380 PU 4



4 004470 611380

Art. no. 611 390
EAN 4 004 470 611 397 PU 3



4 004470 611397



70

Fan heater
HL 1095 CB

- 2 heat settings (1000/2000 watt max.)
- Cold (ventilator)
- Infinitely adjustable thermostat
- Indicator light
- 2 different ways of setting up
- Safe base
- Sturdy carrying handle
- Overheating protection

- 220–240 V, 50 Hz, 1800–2000 W
- W x H x D approx. 248 x 120 x 250 mm

Fan heater
HL 1096 CB

- 2 heat settings (1000/2000 watt)
- Cold (ventilator)
- Infinitely adjustable thermostat
- Indicator light
- Safe base
- Sturdy carrying handle
- Overheating protection

- 220–240 V, 50 Hz, 1800–2000 W
- W x H x D approx. 230 x 262 x 138 mm



2 different ways of setting up

Art. no. 610 950
EAN 4 004 470 109 504 PU 4



Art. no. 610 960
EAN 4 004 470 109 603 PU 4





Ceramic fan heater HL 1097 CB

- PTC ceramic heater element for healthy, safe, quiet and efficient heating
 - Low dust accumulation
 - Quick and effective heating
 - Long service life
 - Robust and durable
 - 7 level switches
 - 2 heat settings (750/1500 W)
 - Oscillating (can be deactivated)
 - Cold setting (fan blower)
 - Steplessly adjustable thermostat
 - Safety switch for fire protection
 - Stable stand
 - Robust carry handle (foldable)
 - Overheat protection
- 220–240 V, 50 Hz, 1500 W
 - W x H x D approx. 191 x 267 x 141 mm

Ceramic fan heater HL 1120 CB

- PTC ceramic heater element for healthy, safe, quiet and efficient heating
 - Low dust accumulation
 - Quick and effective heating
 - Robust and insensitive by durable ceramic heater
 - 4 level switches
 - 2 heat settings (1000/2000 W)
 - Adjustable angle of inclination (90°)
 - Cold setting (fan blower)
 - Steplessly adjustable thermostat
 - High stability due to sturdy metal frame
 - Robust carry handle
 - Overheating protection
- 220–240 V, 50 Hz, 2000 W
 - W x H x D approx. 210 x 217 x 160 mm



Oscillating

Art. no. 610 971
EAN 4 004 470 109 719 PU 4



Art. no. 611 209
EAN 4 004 470 112 092 PU 4





12 V connector
for car operation



NEW! Cool bag
KT 6013 CB

- Insulated thermal cool bag – ideal for camping, travel and shopping
 - Capacity (gross capacity): approx. 15 litre max.
 - For all standard 0.5/0.75/1.0 litre bottles
 - Uniform cooling by means of external ventilator
 - Cooled up to 12°C max. below ambient temperature
 - Powerful, maintenance-free Peltier cooling system
 - Durable material (splash-proof)
 - High quality isolation
 - Main compartment with zipper and 3 additional external storage compartments
 - Easy-to-clean interior
 - Adjustable shoulder strap for high wearing comfort
 - Cool bag foldable (space-saving)
 - Accessory: 12 V connecting cable for car operation
- Power supply: DC 12 V, 50 W
 - WxHxD ca. 330 x 260 x 250 mm



3 additional, external
storage compartments



Even cooling by external
fan



For all standard 0.5/0.75/1.0 litre bottles



Adjustable shoulder strap for
a comfortable fit

Art. no. 660 131
EAN 4 004 470 601 312 PU 3



4 004470 601312



12 V connector



230 V connector



NEW! Cool box KB 6011 CB

- Perfect for camping, travel and shopping
 - Capacity (gross capacity): 25 litre max.
 - For all standard 0.75 / 1.0 / 1.5 / 2.0 litre bottles
 - Even cooling by integrated fan
 - Cooled up to 18 °C max. below ambient temperature
 - Powerful, maintenance-free Peltier cooling system
 - Energy saving function (ECO SAVE)
 - Double walled plastic casing with high quality isolation
 - Special sealing rubber in the lid reduces condensation
 - Foldable handle
 - Removable lid
 - Cable storage compartment
 - Accessory: 12 V connecting cable for car operation, 230 V connecting cable
- Power supply:
 - Mains adapter connection: DC 12 V, 45 W
 - Mains adapter connection: AC 220-240 V, ~ 50/60 Hz, 55 W, 8.5 W (ECO mode)
 - W x H x D approx. 355 x 495 x 240 mm
 - Energy efficiency class: A++

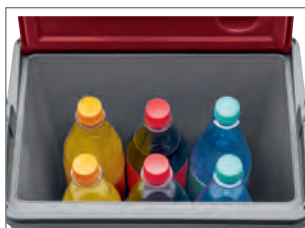

For all standard 0.75 / 1.0 / 1.5 / 2.0 litre bottles



Cord storage compartment

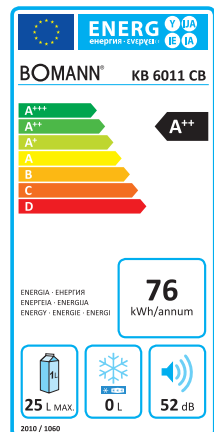

Art. no. 660 103
EAN 4 004 470 601 039 PU 1



4 004470 601039



12 V connector



230 V connector



NEW! Cool box
KB 6012 CB

- Perfect for camping, travel and shopping
 - Suitable for cooling and warming
 - Capacity (gross capacity): 30 litre max.
 - For all standard 0.75 / 1.0 / 1.5 litre bottles
 - Even cooling by integrated fan
 - Cooled up to 18 °C max. below ambient temperature
 - Powerful, maintenance-free Peltier cooling/heating system
 - Energy saving function (ECO Save)
 - Rugged, double walled plastic casing with high quality isolation
 - Special sealing rubber in the lid reduces condensation
 - Foldable handle
 - Removable lid
 - Accessory: 12 V connecting cable for car operation, 230 V connecting cable
- Power supply:
 - Mains adapter connection: DC 12 V, 52/48 W
 - Mains adapter connection: AC 220-240 V, ~ 50/60 Hz, 68/63 W, 8,5 W (ECO mode)
 - W x H x D approx. 400 x 435 x 295 mm
 - Energy efficiency class: A++



For all standard 0.75 / 1.0 / 1.5 litre bottles

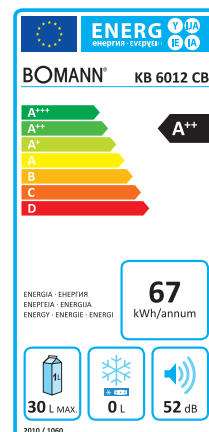

Art. no. 660 104
EAN 4 004 470 601 046 PU 1





2in1

Fireplace + Heater

Electric fireplace

EK 6020 CB

75

- Electric fireplace with flame simulation and fan heater function
 - 2-stage fan heater 900 W or 1800 W, switching-on as required or automatic (overheating protection)
 - Flame effect switchable in 5 steps
 - Glass front
 - Wall mounting
 - Control via remote control possible
 - Removable window for easy cleaning
 - Display may be faded-in to indicate the time, day of the week, brightness of the flames, heating power, room temperature display, timer programming
 - On/off switch
 - Close-up operation on the appliance
-
- 220–240 V, 50 Hz
 - Heating power 900 W or 1800 W
 - WxHxD approx. 660 x 520 x 95 mm



Multifunction display

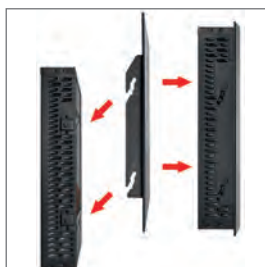

Glass removable



Heater function

Art.no 660 201
 EAN 4 004 470 602 012 PU 1





2in1

Fireplace + Heater

Electric fireplace
EK 6021 CB

76

- Electric fireplace with flame simulation and fan heater function
 - 2-stage fan heater 900 W or 1800 W, switching-on as required or automatic (overheating protection)
 - Ambient lighting via laterally mounted LEDs adjustable in 7 different combinations – switching-on as required
 - Flame effect switchable in 5 steps
 - Curved glass front
 - Wall mounting
 - Control via remote control possible
 - Removable window for easy cleaning
 - Display may be faded-in to indicate the time, day of the week, brightness of the flames, heating power, room temperature display, timer programming
 - On/off switch
 - Close-up operation on the appliance
-
- 220–240 V, 50 Hz
 - Heating power 900 W or 1800 W
 - WxHxD approx. 650 x 520 x 114 mm



Heater function

STEP 07	STEP 06	STEP 05	STEP 04	STEP 03	STEP 02	STEP 01
Red	Blue	Orange	Red+ Blue	Red+ Orange	Blue+ Orange	Red+ Blue+ Orange



Multifunction display

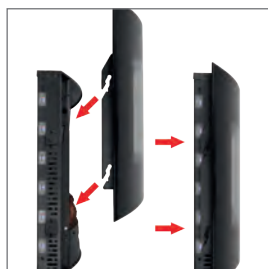

Glass removable

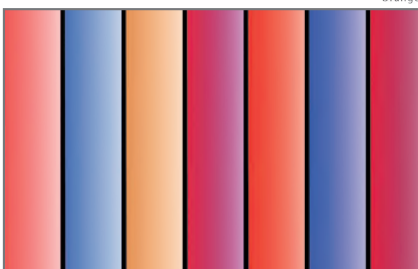

Adjustable ambient lighting in seven different combinations

Art. no. 660 211
EAN 4 004 470 602 111 PU 1



4 004470 602111



2in1

Fireplace + Heater

Electric fireplace
EK 6022 CB

- Electric fireplace with flame simulation and fan heater function
 - 2-stage fan heater 900 W or 1800 W, switching-on as required or automatic (overheating protection)
 - Ambient lighting via laterally mounted LEDs adjustable in 7 different combinations – switching-on as required
 - Flame effect switchable in 5 steps
 - Curved glass front
 - Wall mounting
 - Control via remote control possible
 - Removable window for easy cleaning
 - Display may be faded-in to indicate the time, day of the week, brightness of the flames, heating power, room temperature display, timer programming
 - On/off switch
 - Close-up operation on the appliance
-
- 220–240 V, 50 Hz
 - Heating power 1000 W or 2000 W
 - W x H x D approx. 880 x 560 x 140 mm



Heater function

STEP 07	STEP 06	STEP 05	STEP 04	STEP 03	STEP 02	STEP 01
Red	Blue	Orange	Red + Blue	Red + Orange	Blue + Orange	Red + Blue + Orange



Touch key on the device



Multifunction display

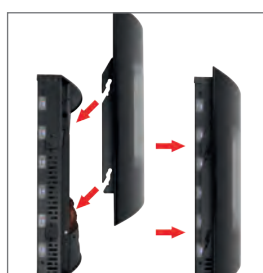

Glass removable

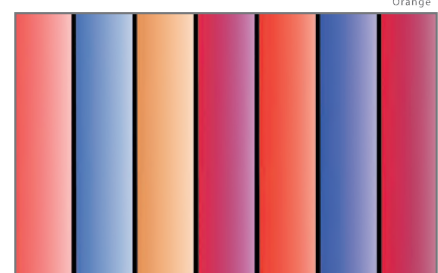

Adjustable ambient lighting in seven different combinations



78

**Replacement bottle/
Replacemant jars**

**Replacement bottle for
Smoothie maker SM 386 CB**

Art. no. 264 559
EAN 4006 160 645 590 PU 6

**Replacement jars for
Yoghurt-Maker JM 1025 CB**

Art. no. 251 125
EAN 4006 160 511 253 PU 4

Replacement cartridges

**Replacement cartridges for
DBS 778 CB, DBS 783 CB**

Art. no. 8 934 610
EAN 4006 160 632 583 PU 3

**Replacement cartridges for
DBS 792 CB, DBS 1793**

Art. no. 8 936 110
EAN 4006 160 632 606 PU 3

**Spare rolls
for bag sealer**

**Spare rolls for
FS3261**

Art. no.: 8 900 216
EAN 4 006 160 900 217 PU 10

Replacement balloons

Replacement balloons HBB 6025 CB

Art. no. 263 869
EAN 4 006 160 638 691 PU 1



Dust bags

You will find other accessory articles under www.bomann.de

Vacuum cleaners	Article no.	EAN no.	Bomann type	Swirl type
BS 902 CB	–	–	–	Y 98
BS 911 CB	282047	4 006 160 820 478	SSB 101	Y 05
CB 940	282047	4 006 160 820 478	SSB 101	Y 93
CB 942	282047	4 006 160 820 478	SSB 101	Y 101
CB 948	282047	4 006 160 820 478	SSB 101	Y 101
CB 949	282047	4 006 160 820 478	SSB 101	Y 05
CB 957	282047	4 006 160 820 478	SSB 101	Y 101
BS 961 CB	282047	4 006 160 820 478	SSB 101	Y 101
CB 965	282047	4 006 160 820 478	SSB 101	Y 93
CB 966	282047	4 006 160 820 478	SSB 101	Y 05
BS 980 CB	282047	4 006 160 820 478	SSB 101	Y 50
BS 985 CB / BS 988 CB	282047	4 006 160 820 478	SSB 101	Y 93
BS 987 CB	282047	4 006 160 820 478	SSB 101	Y 101
BS 989 CB / BS 9014 CB / BS 9019 CB	–	–	–	Y 98
CB 991	282047	4 006 160 820 478	SSB 101	Y 05
BS 9010 CB / BS 9011 CB / BS 9015 CB / BS 9020 CB	282047	4 006 160 820 478	SSB 101	–



Filter-sets

Vacuum cleaners	Article no.	EAN no.	Bomann type
BS 912 CB	8912800	4 006 160 128 000	Filterset BS 1280
BS 975 CB	282914	4 006 160 829 143	Filterset BS 1253
BS 9018 CB	8900753	4 006 160 007 534	Filterset BS 1294
BS 9019 CB	891 3005	–	Filterset BS 1300
BS 9020 CB	891 3014	–	Filterset BS 1301
BS 9027 CB	891 3020	4 006 160 638 066	Filterset BS 1302



TECHNICAL DATA FOR HOUSEHOLD REFRIGERATORS Commission Delegated Regulation (EU) No. 1060/2010

Bomann				
Model		KB 6011 CB	KB 6012 CB	
Category ¹⁾		10	10	
Energy efficiency class ²⁾ A+++ (highest efficiency) to G (lowest efficiency)		A++	A++	
Consumption data				
Annual energy consumption ³⁾	kWh	76	67	
Net capacity cooling total	l	25	30	
Net capacity freezing	l	0	0	
Star rating ⁴⁾		-	-	
Frost-free		-	-	
Temperature rise time	h	-	-	
Freezing capacity	kg/ 24 h	-	-	
Climate class ⁵⁾		SN/N	SN/N	
Noise level	dB(A) re 1pW	52	52	
Design		mobile	mobile	

¹⁾ Category: 1 = Refrigerator with one or more fresh-food storage compartments, 2 = Refrigerator-cellar, Cellar and Wine storage appliances, 3 = Refrigerator-chiller and Refrigerator with a 0-star compartment, 4 = Refrigerator with a one-star compartment, 5 = Refrigerator with a two-star compartment, 6 = Refrigerator with a three-star compartment, 7 = Refrigerator-freezer, 8 = Upright freezer, 9 = Chest freezer, 10 = Multi-use and other refrigerating appliances.

²⁾ A+++ (highest efficiency) to G (lowest efficiency).

³⁾ Annual energy consumption „XYZ“ kWh per year based on standard test results for 24 h. Actual energy consumption will depend on how the appliance is used and where is located.

⁴⁾ * = compartment: a frozen-food storage compartment in which the temperature is not warmer than -6°C.

*** = compartment: a frozen-food storage compartment in which the temperature is not warmer than -18°C.

(**)** = food freezer compartment in which the temperature is not warmer than -18°C and a minimum freezing capacity in 24 h.

⁵⁾ Climate class SN: ambient temperature of +10°C up to +32°C. Climate class N: ambient temperature of +16°C up to +32°C. Climate class ST: ambient temperature of +16°C up to +38°C. Climate class T: ambient temperature of +16°C up to +43°C.







Headquarter



Logistic Center (approx. 100.000 m²)



Showroom



Quality assurance

BOMANN®

C. Bomann GmbH
Heinrich-Horten-Straße 17
47906 Kempen
Germany

Telephone: +49 2152 8998-0
Telefax: +49 2152 8998-911

mail@bomann.de
www.bomann-germany.de