



Martellato

*Your specialities, our passion.*

2018





# Martellato

*Your specialities, our passion.*

[www.martellato.com](http://www.martellato.com)



## Catalogo 2018

Siamo lieti di presentare il nuovo catalogo dedicato alle attrezzature da laboratorio, pensate per i pasticceri e adatte a tutti i professionisti.

Con un'ampia gamma di articoli, tradizionali ed innovativi, il catalogo Martellato vuole rappresentare il punto di riferimento per i diversi settori del comparto food.

Frutto della collaborazione tra l'area Ricerca e Sviluppo e quella Commerciale, gli articoli, contraddistinti dal logo con la corona, garantiscono qualità, ricerca e studio rispondono alle reali esigenze dei professionisti.

Per Martellato, Made in Italy è design ed innovazione, è l'identità che esprime i valori del territorio e quella particolare attenzione verso i prodotti.

La selezione delle materie prime e il rispetto delle più rigorose norme, fa dei prodotti Martellato degli strumenti sicuri e di lunga durata. Inoltre, l'accurata scelta dei fornitori e delle lavorazioni, principalmente interne, permette di offrire dei prodotti di qualità ad un prezzo competitivo.

## Martellato: una storia tutta italiana

Un'azienda nata più di trent'anni fa e che oggi rappresenta una realtà innovativa e di respiro internazionale, pur conservando intatti l'ingegno e il "saper fare" tipici dell'artigianalità.

Due generazioni di imprenditori hanno sviluppato i loro prodotti confrontandosi con le esigenze dei clienti, inizialmente pasticceri e gelatieri, ed oggi anche professionisti dell'intero settore Horeca.

Nel moderno stabilimento inaugurato nel 2014 è organizzata la struttura operativa che concentra sul territorio italiano la direzione, la logistica e la produzione.

Presente in tutto il mondo, avvalendosi di una capillare rete distributiva, per presidiare i principali mercati

di riferimento: Europa, America, Nord Africa, Medio Oriente e Sud-Est asiatico.

## 2018 Catalogue

We are pleased to present our new catalogue dedicated to equipment designed for confectioners and suitable for all professionals.

With a wide range of both traditional and innovative items, Martellato catalogue wants to represent the point of reference for the various food sectors.

Fruit of the cooperation between Research & Development and the Sales Department, the items, characterized by the crown logo, guarantee quality, research and study and meet professionals' real requirements.

For Martellato, Made in Italy is design and innovation, the identity expressing the values of the territory and that special attention towards products.

The selection of the raw materials and compliance with the most rigorous standards makes Martellato products safe and long-lasting tools. Moreover, the accurate choice of suppliers and mainly in-house processes allows offering quality products at competitive prices.

## Martellato: an Italian story

A company started over thirty years ago, that today represents an innovative reality of international standing, retaining at the same time the resourcefulness and "know-how" typical of craftsmanship.

Two generations of entrepreneurs have developed their products facing the requirements of its customers, at the start confectioners and ice cream makers, and today also professionals of the whole Horeca sector.

The modern plant opened in 2014 houses the company operational structure that concentrates management, logistics and production in Italy. Present all over the world with a capillary distribution network to control the main reference markets: Europe, North and South America, North Africa, the Middle-East and South-East Asia.

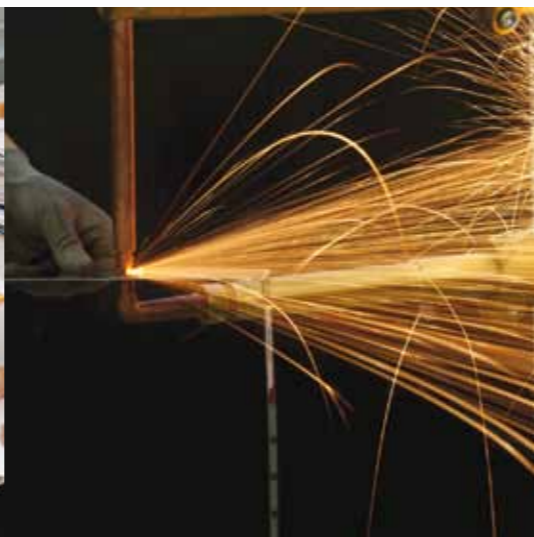
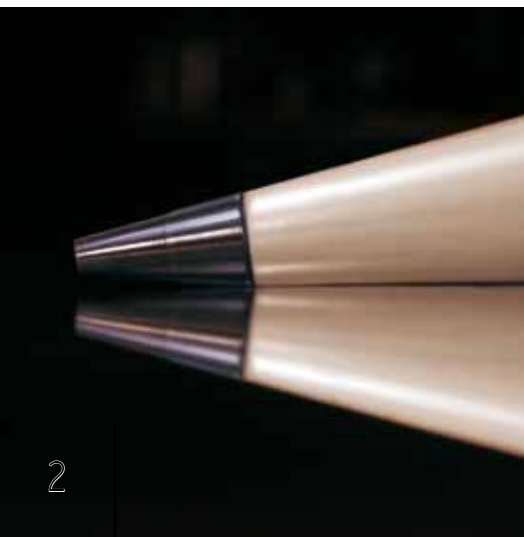





## Qualità e personalizzazione

Molti prodotti presenti in questo catalogo, grazie alla flessibilità progettuale e produttiva di Martellato potranno essere personalizzati seguendo le richieste della clientela.

L'obiettivo principale è offrire un servizio di qualità ed esperienza che sappia modellarsi sulla base di ogni esigenza in maniera flessibile: dai grandi gruppi alle piccole aziende, per essere vicini al modo di vedere dei nostri clienti.

L'ufficio progettazione è a disposizione per studiare la fattibilità di nuovi prodotti che rispondano ad esigenze specifiche, consentendo all'idea del cliente, attraverso un iter progettuale ed un confronto propositivo, di concretizzarsi in un prodotto funzionale e di grande estetica.

Potranno essere creati stampi con decori e scritte personalizzati, così come si possono studiare packaging su misura.

Articoli tradizionali come raschietti, spatole e sac a poche oppure stampi e monouso o ancora eleganti alzate in plexiglass, potranno essere customizzati con il logo del cliente.

Particolarmente apprezzata è la possibilità che l'azienda offre di customizzare il prodotto in plexiglass apponendo il proprio marchio tramite stampa a laser, ideale per articoli di particolare pregio e raffinatezza, o stampa serigrafica ad uno o più colori.

## Quality and customization

Thanks to Martellato's design and production flexibility, many products in this catalogue can be tailored in compliance with customers' requirements.

The main objective is offering a quality and experienced service that can shape itself flexibly on the basis of any requirement: from big groups to small companies, to be near our customers' viewpoint.

Our design department is available to study the feasibility of new products that meet special requirements, allowing the customer's idea to materialize in a functional and superb-looking product, through a design project and positive comparison.

Moulds with customized decorations and writings, as well as ad-hoc packaging can be created.

Traditional articles such as scrapers, spatulas and pastry bags as well as moulds and disposable items or elegant plexiglass cake stands can be customized with the customer's logo.

Particularly appreciated is the possibility the company offers of customizing plexiglass products with a logo using laser printing, ideal for particularly elegant and refined articles, or single or multiple colour screen-printing.





# INDICE INDEX

CIOCCOLATO CHOCOLATE	9
MACCHINE PROFESSIONALI PROFESSIONAL MACHINES	127
SEMIFREDDO & COTTURA SEMIFREDDO & BAKING	145
GELATO ICE CREAM	197
ATTREZZATURE EQUIPMENT	225
DECORAZIONE DECORATION	293
HORECA	313



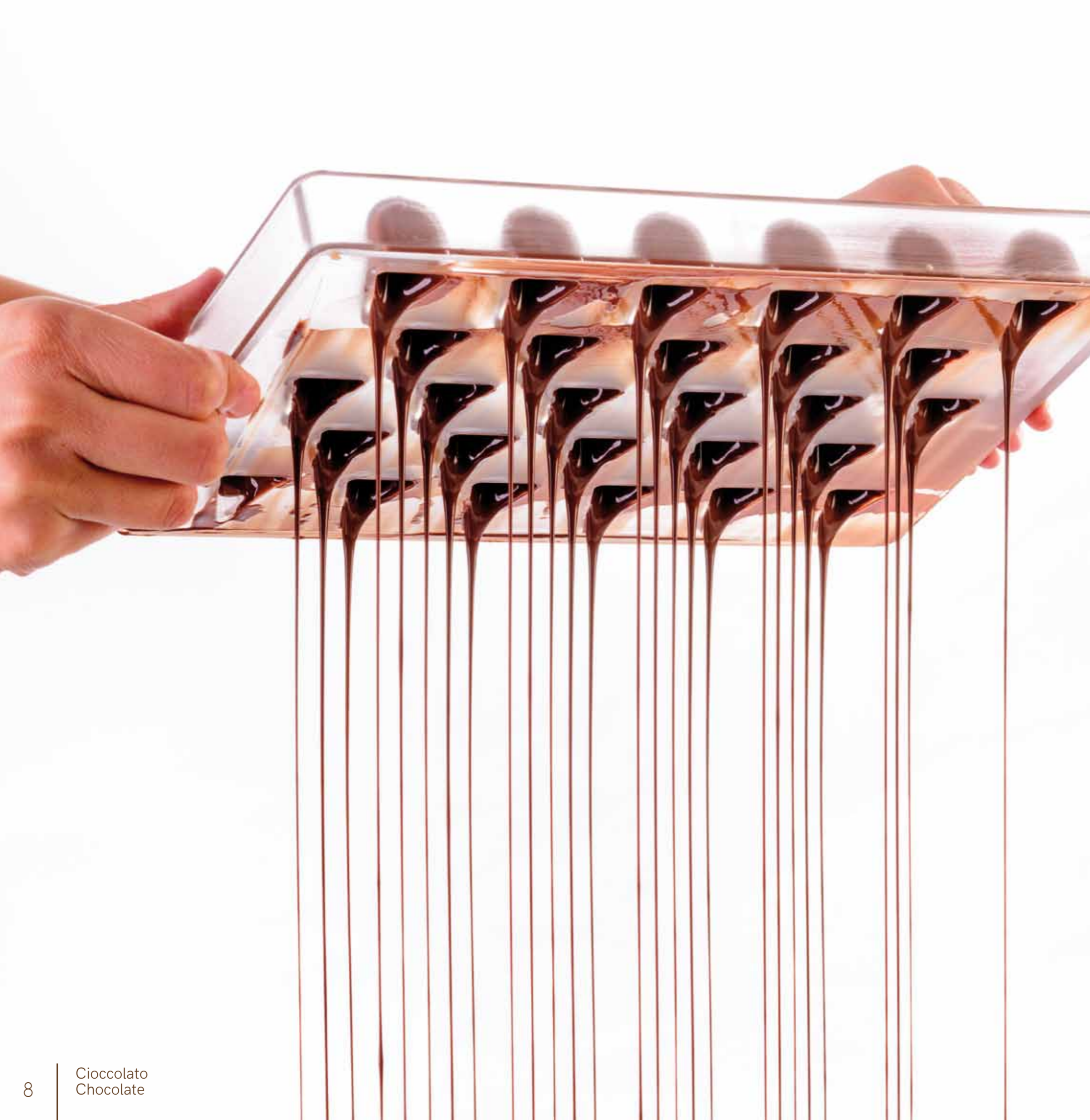

## CIOCCOLATO CHOCOLATE

PRALINE	10
TAVOLETTE/BAR	20
SNACK	22
NAPOLITAIN	23
DECORAZIONI/DECORATIONS	36
SOGGETTI/ FIGURES	42
NATALE/CHRISTMAS	58
PASQUA/EASTER	82
EVENTI/EVENTS	106



# PRALINE

La qualità del policarbonato utilizzato per la produzione degli stampi Martellato, garantisce un'ottimale produzione di praline di cioccolato lucenti ed eleganti.

The quality of the polycarbonate used to produce Martellato moulds assures the best production of bright and elegant shapes and chocolate pralines.

Policarbonato - Polycarbonate  
Stampo - Mould: 275x175 mm



## CLASSIC



**MA1002**  
28 pcs - Ø30 h19mm  
~ 12 gr



**MA1019**  
40 pcs - 25x25 h23mm  
~ 13 gr



**MA1025**  
30 pcs - 33x22 h20mm  
~ 15 gr



**MA1029**  
32 pcs - 39x28 h17mm  
~ 12 gr



**MA1032**  
32 pcs - 38x22 h15mm  
~ 10 gr



**MA1037**  
40 pcs - Ø29 h21mm  
~ 8 gr

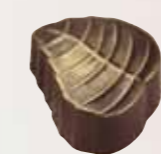

**MA1046**  
28 pcs - 37x31 h16mm  
~ 14 gr



**MA1064**  
36 pcs - 35x23 h16mm  
~ 9 gr



**MA1074**  
30 pcs - 38x28 h18mm  
~ 15 gr



**MA1082**  
30 pcs - 35x20 h17mm  
~ 12 gr



**MA1088**  
32 pcs - 39x26 h19mm  
~ 14 gr



**MA1091**  
40 pcs - Ø28 h24mm  
~ 11 gr



**MA1094**  
28 pcs - Ø30 h22mm  
~ 14 gr



**MA1335**  
30 pcs - 35x22 h15mm  
~ 7 gr



**MA1529**  
42 pcs - 32x22 h15mm  
~ 8 gr



**MA1530**  
40 pcs - Ø26 h19mm  
~ 9 gr



**MA1605**  
15 pcs - 40x32 h11mm  
~ 7 gr



**MA1607**  
24 pcs - Ø27 h17mm  
~ 9 gr



**MA1609**  
24 pcs - 30x23 h18mm  
~ 9 gr



**MA1610**  
24 pcs - Ø29 h18mm  
~ 9 gr

Su richiesta disponibili in versione BPA FREE  
On request available BPA free





**MA1611**  
24 pcs - Ø30 h15mm  
~9 gr



**MA1612**  
20 pcs - 38x30 h15mm  
~9 gr



**MA1614**  
24 pcs - 30x24 h12mm  
~8 gr



**MA1615**  
20 pcs - 38x25 h12mm  
~9 gr



**MA1617**  
24 pcs - 31x23 h12mm  
~8 gr



**MA1618**  
24 pcs - Ø30 h20mm  
~9 gr

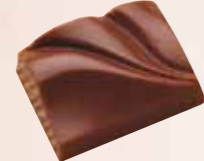

**MA1620**  
24 pcs - 33x25 h12mm  
~8 gr



**MA1621**  
24 pcs - 33x33 h15mm  
~9 gr

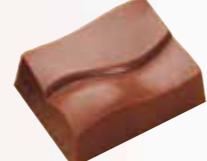

**MA1622**  
24 pcs - 30x24 h12mm  
~9 gr



**MA1631**  
30 pcs - 30x18 h15mm  
~7 gr



**MA1293**  
28 pcs - Ø23 h21mm  
~12 gr



**MA1303**  
28 pcs - 27x27 h18mm  
~11 gr



**MA1350**  
30 pcs - Ø28 h25mm  
~11 gr



**MA1521**  
28 pcs - Ø28 h18mm  
~10 gr



**MA1602**  
20 pcs - 35x27 h12mm  
~9 gr



**MA1632**  
30 pcs - 30x18 h15mm  
~8 gr



**MA1640**  
16 pcs - 48x18,5 h19mm  
~10 gr



**MA1906**  
28 pcs - 30x19 h17mm  
~8 gr



**MA1907**  
28 pcs - 29,5x19 h17mm  
~7 gr



**MA1908**  
27 pcs - 26,5x22,5 h16,5mm  
~7 gr



**MA1603**  
24 pcs - 32x23 h13mm  
~8 gr



**MA1604**  
24 pcs - 30x25 h15mm  
~9 gr



**MA1606**  
24 pcs - 30x30 h12mm  
~9 gr



**MA1608**  
20 pcs - 33x25 h12mm  
~9 gr



**MA1616**  
28 pcs - 27x27 h13mm  
~9 gr



**MA1909**  
28 pcs - 27,5x19,5 h17mm  
~8 gr



**MA1960**  
35 pcs - 30x25 h15mm  
~6 gr



**MA1969**  
30 pcs - 40x20 h18mm  
~8 gr



**MA1970**  
30 pcs - 40x18 h15mm  
~9 gr



**MA2003**  
28 pcs - 20x20 h16mm  
~6 gr



**MA1619**  
18 pcs - 29x29 h12mm  
~9 gr

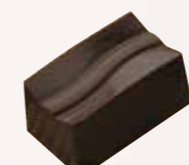

**MA1625**  
30 pcs - 30x18 h15mm  
~8 gr



**MA1626**  
30 pcs - 31x20 h16mm  
~7 gr



**MA1627**  
30 pcs - 35x20 h15mm  
~7 gr



**MA1628**  
30 pcs - 30x18 h15mm  
~7 gr



**MA1629**  
30 pcs - 30x18 h15mm  
~8 gr



**MA1630**  
30 pcs - 30x18 h15mm  
~8 gr



**MA1634**  
30 pcs - 32x19 h15mm  
~7 gr



**MA1635**  
30 pcs - 32x22 h15mm  
~7 gr



**MA1638**  
30 pcs - 34x25 h15mm  
~8 gr



**MA1800**  
28 pcs - 22x22 h22mm  
~8 gr



**MA1801**  
28 pcs - 26x20 h21mm  
~8 gr



**MA1802**  
28 pcs - Ø24 h21mm  
~7 gr



**MA1803**  
28 pcs - 26x20 h21mm  
~8 gr



**MA1804**  
28 pcs - Ø25 h18,5mm  
~7 gr



**MA1900**  
28 pcs - 29x19 h16mm  
~8 gr



**MA1901**  
28 pcs - 27x23 h14mm  
~8 gr



**MA1903**  
28 pcs - 28x20 h17mm  
~7 gr



**MA1904**  
28 pcs - 30x20 h17,5mm  
~8 gr



**MA1905**  
28 pcs - 30,5x19,5 h18mm  
~8 gr





**MA1963**

30 pcs - Ø27 h20mm  
~7 gr



**MA1964**

30 pcs - Ø27 h20mm  
~7 gr



**MA1965**

30 pcs - 25x25 h15mm  
~7 gr



**MA1966**

30 pcs - 25x25 h15mm  
~9 gr



**MA1967**

30 pcs - 25x25 h15mm  
~9 gr



**MA1968**

30 pcs - 25x25 h15mm  
~7 gr



**MA1971**

30 pcs - 40x18 h16mm  
~8 gr



**MA1972**

30 pcs - 26x26 h20mm  
~7 gr



**MA1980**

24 pcs - 25x25 h13mm  
~9 gr



**MA1981**

24 pcs - Ø35 h15mm  
~11 gr



**MA1982**

28 pcs - 28x28 h16mm  
~11 gr



**MA1983**

28 pcs - 24x24 h18mm  
~10 gr



**MA1985**

20 pcs - 41x24 h20mm  
~10 gr



**MA1986**

28 pcs - 30x30 h11mm  
~11 gr



**MA1987**

24 pcs - 35x23 h17mm  
~10 gr



**MA1988**

24 pcs - 30x30 h8mm  
~8 gr



**MA1989**

24 pcs - Ø35 h8mm  
~8 gr

## HEARTS



**MA1993**

24 pcs - 33x33 h 15mm  
~10gr



**MA1513**

28 pcs - 34x33 h11mm  
~7 gr



**MA1526**

35 pcs - 34,7x22 h16mm  
~8 gr



**MA1613**

15 pcs - 40x42 h15mm  
~9 gr



**MA1962**

30 pcs - 31x27 h14mm  
~8 gr

## FANTASY



**MA1281**

130 pcs - 17x12 h5mm  
~1 gr

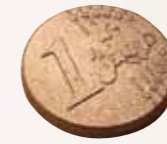

**MA1467**

24 pcs - Ø34 h4mm  
~4 gr



**MA1493**

28 pcs - Ø28 h16mm  
~10 gr



**MA1525**

42 pcs - 31x26 h15,5mm  
~9 gr



**MA1527**

35 pcs - 31x24 h13mm  
~8 gr



**MA1624**

32 pcs - 28x32 h15mm  
~8 gr



**MA1633**

35 pcs - Ø26 h15mm  
~8 gr



**MA1636**

24 pcs - 30x30 h15mm  
~8 gr



**MA1637**

30 pcs - 32x24 h15mm  
~8 gr



**MA1976**

32 pcs - 33x26 h17mm  
~8 gr

## MULTI

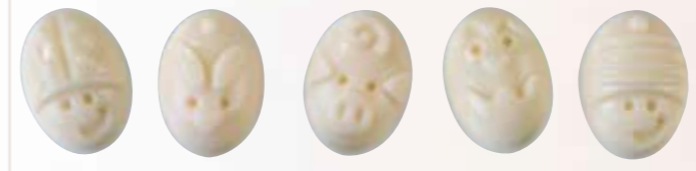

**MA1979**

5x6 pcs - 33x24 h18mm  
~8 gr



**MA1961**

5x6 pcs - 30x25 h25mm  
~8 gr



**MA1958**

5x7 pcs - 30x24 h17mm ~7 gr



**MA1959**

5x7 pcs - 30x24 h17mm ~7 gr

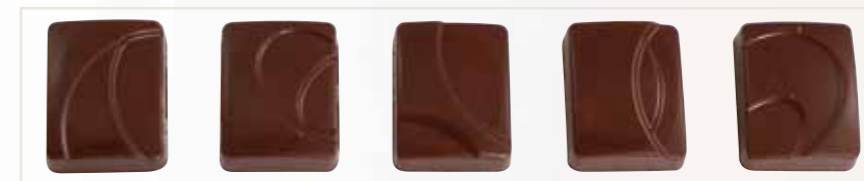

**MA1977**

5x6 pcs - 30x24 h11mm ~7 gr



# Diamond

*chocolate jewels* 



  
*Stampi in policarbonato  
per creare preziose praline di cioccolato*

*Polycarbonate moulds  
to create precious pralines*



*Heart*

**MA1993**  
33x33 h 15mm ~ 10gr  
Prod. 24 pcs



*Jems*

**MA1994**  
6 square - 30x30 h 15mm ~ 11gr  
6 oval - 42x24 h 15mm ~ 10gr  
6 round - Ø32 h 15mm ~ 10gr

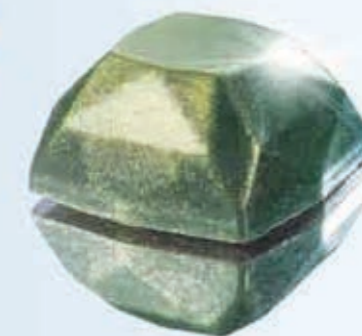



# CHOCO Style

Tavolette, Snack, Napolitain



Una gamma completa di stampi policarbonato per tavolette, snack e napolitain coordinati fra di loro. Grazie alle geometrie che li caratterizzano, i coordinati offrono interessanti possibilità di decorazione, creando raffinate proposte per ingolosire i clienti amanti dello style.

Martellato presents a complete range of polycarbonate moulds for bars, snacks and napolitain coordinated among themselves. Due to the geometries that characterize them they offer interesting possibilities for creating refined decoration proposals to tempt even the most demanding customers.

**MA2009**  
3 pcs 138x72 h11mm  
~80 gr



**MA6002**  
20 pcs 42x25 h6mm  
~4 gr



**MA1915**  
8 pcs 123x27 h12mm  
~30 gr



**MA2008**  
3 pcs 117x71 h13mm  
~80 gr



**MA1914**  
8 pcs 100x26 h16mm  
~30 gr

**MA6001**  
24 pcs 31x31 h4,5mm  
~4 gr

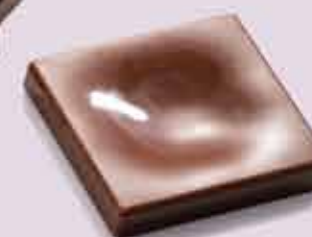



# TAVOLETTE - BARS

## POLYCARBONATE MOULDS

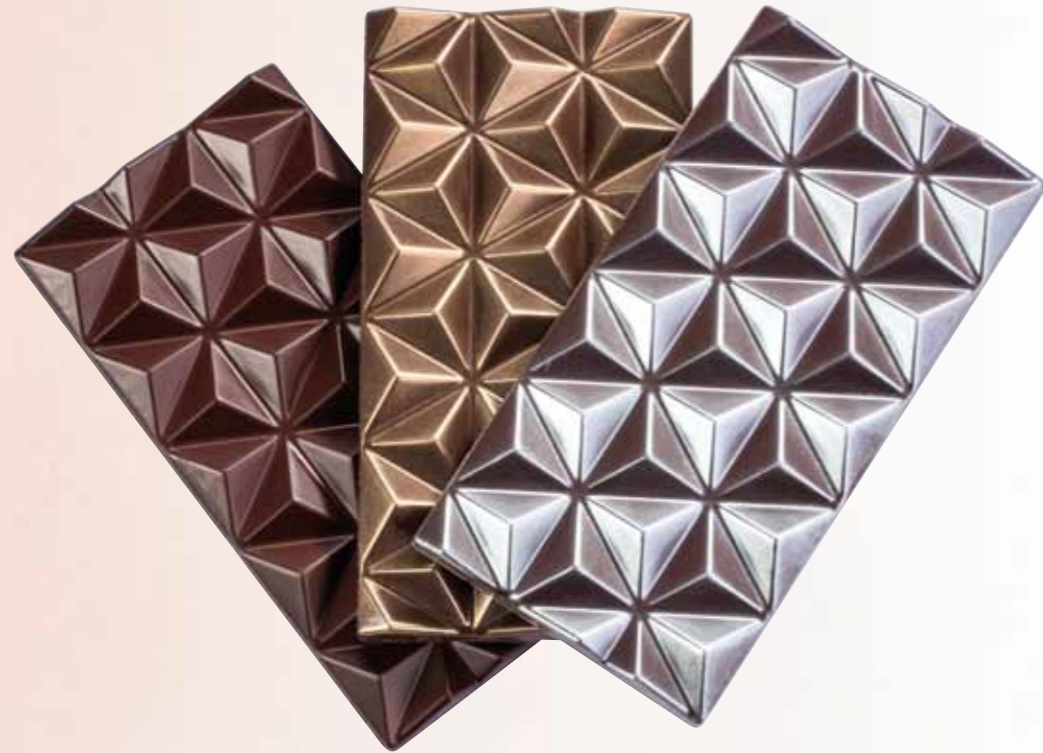

**MA2009**  
3 pcs 138x72 h11mm  
~80 gr



**MA2008**  
3 pcs 117x71 h13mm  
~80 gr

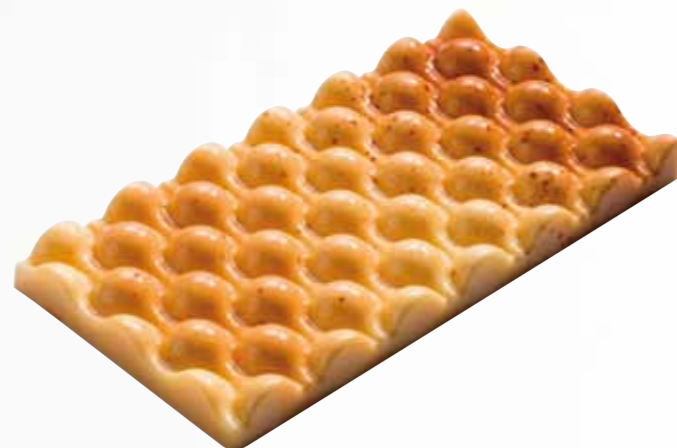

**MA2010**  
3 pcs 132x68 h11mm  
~80 gr



**MA2000**  
3 tav./ bars 150x70 h11mm  
114 gr



**MA2001**  
3 tav./ bars 160x75 h8mm  
110 gr



**MA2004**  
4 tav./ bars 130x55 h8mm  
67 gr



**MA2005**  
3 tav./ bars 159x80 h9mm  
64 gr

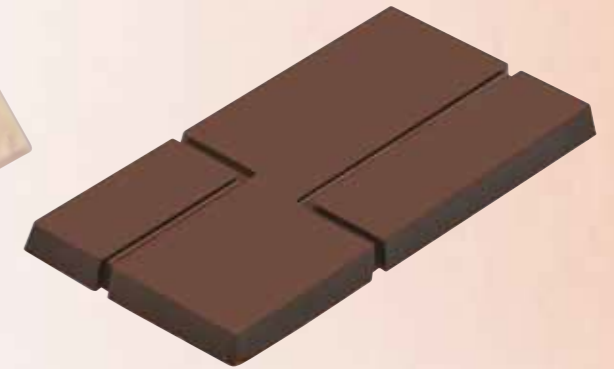

**MA1807**  
3 pcs 154x74 h10mm  
124 gr approx

## THERMOFORMED MOULDS



**TC001/5**  
150x70 h10mm  
Pack 5 pcs



**TC002/5**  
150x70 h10mm  
Pack 5 pcs



**TC003/5**  
150x70 h10mm  
Pack 5 pcs





# SNACK

## POLYCARBONATE MOULDS



**MA1918**  
12 pcs 81x27 h15mm  
~ 30 gr



**NEW**  
**MA1995**  
12pcs - 45x42 h 16mm



**MA1914**  
8 pcs 100x26 h16mm  
~30 gr



**MA1915**  
8 pcs 123x27 h12mm  
~ 30 gr



**MA1917**  
8 pcs 115x24 h15mm  
~ 30 gr



**MA1916**  
8 pcs 100x29 h14mm  
~ 30 gr



**MA1910**  
8 pcs 99x33 h10mm  
~ 32 gr



**MA1911**  
8 pcs 103x29 h12,5mm  
~ 36 gr



**MA1912**  
8 pcs 112x32,5 h15,5mm  
~ 33 gr



**MA1913**  
8 pcs 119x29 h10mm  
~ 34 gr



**MA1805**  
8 pcs 58x58 h10mm  
~ 35 gr



**MA1806**  
8 pcs 119x29 h10mm  
~ 35 gr



**MA1700**  
6 pcs 110x37 h10mm  
~ 23 gr

# NAPOLITAIN

## POLYCARBONATE MOULDS



**MA6005**  
20 pcs 45x23 h6mm  
~4 gr



**MA2007**  
12 pcs - 74x33 h5mm  
~ 13 gr



**MA6001**  
24 pcs 31x31 h4,5mm  
~ 4 gr



**MA6002**  
20 pcs 42x25 h6mm  
~4 gr



**MA6003**  
15 pcs Ø39 h4,5mm  
~4 gr



**MA6004**  
20 pcs 42x27 h5mm  
~4 gr



**MA2002**  
24 pcs 32x32 h4mm  
~5 gr



**MA2006**  
16 pcs - 50x26 h3mm  
~5 gr



**MA1978**  
3x8 pcs - 30x32 h5mm  
~5 gr



# choco and the City

Il giro del mondo con il cioccolato. Le 8 più famose città del pianeta si incontrano negli stampi in policarbonato per dare vita a tavolette, snack e napolitain dedicate a chi ama viaggiare.

All around the World thanks to chocolate. The 8 most famous cities on the planet meet in polycarbonate moulds to create bars, snacks and napolitain dedicated to those who love travelling.

Policarbonato - Polycarbonate  
Stampo - Mould: 275x175 mm



## TAVOLETTE - BARS

**MA2011**  
3 pcs 76x150 h 7 mm  
~ 80 gr



## NAPOLITAIN

**MA6006**  
8x3 pcs 34x34 h 4 mm  
~ 4 gr



## SNACK

**MA1919**  
3x2 pcs 113x39 h 10 mm  
~ 45 gr



Elegante  
Packaging



# CHOCOFRUIT

Dalla collaborazione con il maestro cioccolatiere Massimo Carnio nascono gli innovativi stampi 3D in policarbonato per realizzare eleganti praline a forma di frutta.

Facili da decorare con differenti tecniche, si riempiono e si svuotano con semplicità, grazie anche ad un dettaglio sul fondo che assicura un lavoro pulito e di maggior precisione.

Progettati per permettere un'ottimale cristallizzazione del cioccolato e una facile sformatura, consentono la creazione di sottili camicie per accogliere emozionanti farciture con attenzione anche alla produttività ed alla grammatura dei cioccolatini.

From the cooperation with master chocolatier Massimo Carnio, come the innovative 3D polycarbonate moulds to make elegant pralines shaped as fruit.

Easy to decorate with different techniques, they are simply filled and emptied, thanks also to a detail on the bottom that ensures a clean and more precise job.

Designed to allow optimal chocolate crystallisation and easy mould release, they allow creating thin shells for thrilling fillings, paying also attention to productivity and the weight of the chocolates.

*Le Praline tridimensionali a forma di frutta*  
*Tridimensional fruit-shaped pralines*



*“Un cioccolatino d'élite che non si è mai visto prima!”*  
*“An élite chocolate that's never been seen before!”*

*Qui Massimo*



**Apple**

**20FRUIT01**

28 pcs Ø28 h27 mm  
Pack 1 pcs  
~ 12 gr



**PEAR**

**20FRUIT02**

28 pcs Ø26 h36 mm  
Pack 1 pcs  
~ 12 gr



**STRAWBERRY**

**20FRUIT03**

28 pcs Ø28 h32 mm  
Pack 1 pcs  
~ 12 gr

MADE IN ITALY



# PRALINE 3D

Stampo in policarbonato composto da tre parti. Base ed il coperchio che definiscono la forma della pralina 3D, dotate di calamite. Il terzo componente è una placca forata per una pratica e veloce lisciatura dello stampo, dopo lo svuotamento del cioccolato in eccesso.

Moulds made of polycarbonate composed of three parts. Base and the lid which define the shape of 3D pralines both equipped with magnets. The third component is perforated plate for a practical and fast smoothing after draining the excess chocolate.



Policarbonato - Polycarbonate  
Stampo - Mould: 275x175 mm



**Ovetto - Egg**  
**20-3D1001**  
23x30 h 23 mm  
28pcs ~8gr



**Ovetto - Egg**  
**20-3D1002**  
23x32 h 23 mm  
28pcs ~8gr



**Ovetto - Egg**  
**20-3D1003**  
23x30 h 23 mm  
28pcs ~8gr



**Sfera - Sphera**  
**20-3D2001**  
26x26 h 26 mm  
28pcs ~8gr



**Sfera - Sphera**  
**20-3D2002**  
26x26 h 26 mm  
28pcs ~8gr



**Sfera - Sphera**  
**20-3D2003**  
26x26 h 26 mm  
28pcs ~8gr



**Sfera - Sphera**  
**20-3D3001**  
26x26 h 26 mm  
28pcs ~8gr



**Sfera - Sphera**  
**20-3D4001**  
28x24 h 24 mm  
28pcs ~8gr



**Cuoricino - Heart**  
**20-3D5001**  
31x27 h 21 mm  
28pcs ~8gr



**Cuoricino - Heart**  
**20-3D6001**  
32x18 h 28 mm  
28pcs ~8gr

# SEMISPHERES

## POLYCARBONATE MOULDS



**MA5003**  
45 half spheres  
Ø 20mm ~3 gr



**MA5000**  
24 half spheres  
Ø 30mm ~4 gr



**MA5001**  
8 half spheres  
Ø 50mm ~15 gr



**MA5002**  
2 half spheres  
Ø 100mm ~90 gr



## POLYETHYLENE MOULDS



**Kit 6 Stampi - Moulds**  
**20SF001**  
Ø 100 mm - prod 1 pc  
Ø 130 mm - prod 1 pc  
Ø 140 mm - prod 1 pc  
Ø 150 mm - prod 1 pc  
Ø 175 mm - prod 1 pc  
Ø 200 mm - prod 1 pc

**Kit 4 Stampi - Moulds**  
**20SF002**  
Ø 50 mm - prod 6 pcs  
Ø 65 mm - prod 4 pcs  
Ø 75 mm - prod 4 pcs  
Ø 90 mm - prod 2 pcs



# MINI Choco Fill

Con i Mini ChocoFill è possibile creare dei piccoli mignon o delle raffinate praline dall'aspetto originale e invitante.

Using Mini ChocoFill you can prepare small mignon or refined pralines with an original and appetizing look.

Polycarbonato - Polycarbonate  
Stampo - Mould: 275x175 mm



**20GU002**  
Prod. 15 pcs  
Ø40 h17 mm



**20GU003**  
Prod. 24 pcs  
33x31 h20 mm



**20GU004**  
Prod. 24 pcs  
33x33 h23 mm



**20GU005**  
Prod. 24 pcs  
32x42 h29 mm



**20GU006**  
Prod. 28 pcs  
Ø27 h31 mm



**20GU007**  
Prod. 15 pcs  
Ø37 h14 mm



**20GU500**  
Prod. 12 pcs  
44x56 h39 mm



**20GU501**  
Prod. 15 pcs  
Ø40 h18,5 mm



**20GU502**  
Prod. 12 pcs  
44x55 h23 mm



**20GU001**  
Prod. 20 pcs  
Ø32 h37 mm



**ESPO20GU001**  
380x100 h25 mm  
Cap. 20 pcs



# COFFEE TIME



**Big size**  
Polycarbonate

**Tazzine  
Cups**  
**MA1951**  
55x69 h 34mm  
~20 gr  
Prod. 7 pcs

**Piattini  
Saucers**  
**MA1952**  
Ø81 h 8mm  
~10 gr  
Prod. 3 pcs

**Small size**  
Polycarbonate

**Tazzine  
Cups**  
**MA1953**  
47x59 h 30mm  
~17 gr  
Prod. 7 pcs

**Piattini  
Saucers**  
**MA1954**  
Ø67 h 6,5mm  
~9 gr  
Prod. 5 pcs

## Cucchiaini - Spoons

**Polycarbonate**  
**MA3006**  
92x26 h 7mm ~6 gr  
Prod. 13 pcs



**3D Polycarbonate**  
**SCC01**  
25x95 mm  
Prod. 1 pc



**Polyethylene**  
**90-9991**  
160x40 h20mm  
Prod. 4 pcs



La pralina di cioccolato dal design moderno e minimalista lascia il posto ad un'assoluta novità dal sapore vintage.

The modern and minimalist praline design gives way to the novelty of the vintage chocolates.

Polycarbonato - Polycarbonate / Stampo - Mould: 275x175 mm



**Set Valigie - Luggage Set**  
35x13 h29 mm - 6 pcs  
23x10 h19 mm - 6 pcs  
**Fotocamera - Camera**  
34x21 - h30mm - 18 pcs  
**MA4001**



**Telefono - Telephone**  
24x34 - h27mm - 12 pcs  
**Abatjour - Lamp**  
Ø27 - h40mm - 16 pcs  
**MA4000**



**Poltrona - Armchair**  
35x17 - h29mm - 12 pcs  
**Juke Box - Juke Box**  
28x16 - h37mm - 12 pcs  
**MA4002**



**Bilancia - Scale**  
36x30 - h29mm - 8 pcs  
**Sveglia - Alarm clock**  
30x13 - h40mm - 14 pcs  
**MA4003**



# LOLLIPOP



**Uova - Eggs**  
**20L001**

Thermoformed plastic  
Prod. 8 pcs - 52x77 h9 mm ~30 gr

**Tavolette - Bars**  
**20L003**

Thermoformed plastic  
Prod. 8 pcs - 50x75 h9 mm ~30 gr

**Tondi - Round**  
**20L002**

Thermoformed plastic  
Prod. 8 pcs - Ø60 h9 mm ~ 30 gr



**Lollipop**  
**20L004**

Thermoformed plastic  
68x65 h9 mm ~ 34 gr  
Prod. 8 pcs



**Chocolate lollipop moulds**  
**20L005**

Thermoformed plastic  
Albero - Tree: 70x76 h9 mm ~34 gr  
Stella - Star: 77x74 h9 mm ~ 31 gr  
Prod. 8 pcs

**20-C017**  
Rigid plastic mould  
Prod. 6 pcs  
60x70 mm ~30 gr



# PLEXIGLASS DISPLAYS



**29002**

Cap. 20 lollipop  
350x230 h 235mm



**29003**

Cap. 20 lollipop  
270x180 h 145mm



Cap.30 pcs  
295x70 h125 mm

**EL309**  
Fucsia - Fuchsia

**EL306**  
Satinato - Glazed



**EL201**

Cap.66 pcs  
450x240 h145 mm



**EL101**

Cap.56 pcs  
345x280 h40 mm



Cap.19 pcs  
140x175 h370 mm

**EL209**  
Fucsia - Fuchsia

**EL203**  
Arancione - Orange

**EL206**  
Satinato - Glazed

# ACCESSORIES



**Bastoncini per lollipops**  
**Sticks for lollipops**

**20-B001** 105 mm 400 pcs  
**20-B002** 105 mm 100 pcs



**Sacchetti per lollipops**  
**Bags for lollipops**

**20-S001** 80x120 mm 400 pcs  
**20-S002** 80x120 mm 100 pcs  
**20-S003** 90x130 mm 100 pcs



**Bastoncini per cake pops**  
**Sticks for cake pops**

**20-B003**  
128x15mm  
400 pcs



# DECORATIONS

Progettati e realizzati con il preciso intento di fornire al pasticciere un valido strumento per produrre raffinate decorazioni di cioccolato. Decorazioni di grande effetto per donare un tocco di unicità al dessert.

Si consiglia di utilizzare un cioccolato fluido.

Designed and produced to give pastry chefs a perfect tool to create fine chocolate decorations. Wonderful decorations to make your desserts unique.

We recommend using a liquid chocolate.

Polycarbonato - Polycarbonate  
Stampo - Mould: 275x175 mm



**20-D001**  
Prod. 18 pcs - 2/3 gr  
63x h21 mm



**20-D002**  
Prod. 18 pcs - 2/3 gr  
66x h20 mm



**20-D003**  
Prod. 16 pcs - 2/3 gr  
64x h26 mm



**20-D004**  
Prod. 18 pcs - 2/3 gr  
63x h23 mm



**20-D005**  
Prod. 18 pcs - 2/3 gr  
72x h24 mm



**20-D006**  
Prod. 18 pcs - 2/3 gr  
72x h19 mm



**20-D007**  
Prod. 18 pcs - 2/3 gr  
66x h21 mm



**20-D008**  
Prod. 18 pcs - 2/3 gr  
65x h22 mm



**20-D009**  
Prod. 18 pcs - 2/3 gr  
70x h19 mm



**20-D010**  
Prod. 14 pcs - 2/3 gr  
50 x h38 mm



**20-D011**  
Prod. 16 pcs - 2/3 gr  
62 x h31 mm



**20-D012**  
Prod. 12 pcs - 3/4 gr  
50 x h49 mm



**20-D013**  
Prod. 15 pcs - 2/3 gr  
47 x h39 mm



**20-D014**  
Prod. 11 pcs - 2/3 gr  
Ø50 mm





**20-D020**

Prod. 6+6+6 pcs ~ 2/3 gr  
71x71 - 51x51 - 31x31 mm



**20-D021**

Prod. 6+6+6 pcs ~ 2/3 gr  
73x72 - 54x51 - 35x30 mm



**20-D022**

Prod. 9+9 pcs ~ 2/3 gr  
68x81 - 39x47 mm



**20-D023**

Prod. 6+6+6 pcs ~ 2/3 gr  
66x79 - 46x58 - 28x36 mm



**20-D024**

Prod. 12 pcs ~ 2/3 gr  
70x38 mm



**20-D025**

Prod. 10+10 pcs ~ 2/3 gr  
73x44 - 50x24 mm



**20-D026**

Prod. 10+10 pcs ~ 2/3 gr  
41x73 - 20x50 mm



**20-D027**

Prod. 6/6+6/6 pcs ~ 2/3 gr  
38x72 - 33x20 mm

FANTASY

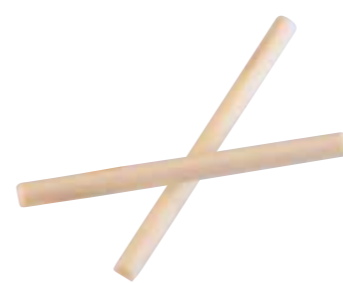

**20-D016**

Prod. 22 pcs - 3/4 gr  
110 x h7 mm



**20-D017**

Prod. 8+8 pcs ~ 2/3 gr  
108x17 - 101x18 mm



**20-D018**

Prod. 10+10 pcs ~ 2/3 gr  
125x4 - 102x17 mm

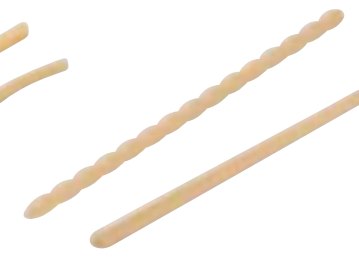

**20-D019**

Prod. 13+13 pcs ~ 2/3 gr  
123x4 - 109x5 mm



**20-D015**

Prod. 12 pcs - 12 gr  
129 x h17 mm

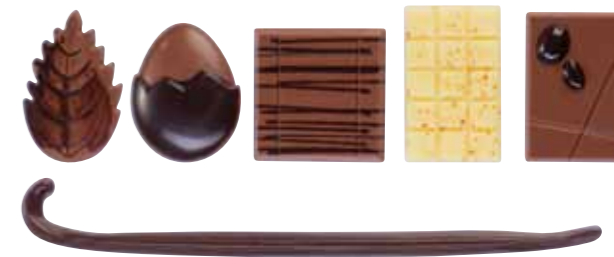

**20-D028**

22 pcs mix



**MA3000**

Prod. 6 pcs ~ 8 gr  
40x106 mm



**MA3001**

Prod. 6 pcs ~ 8 gr  
39x104 mm



**MA3002**

Prod. 6 pcs ~ 8 gr  
56x83 mm



**MA3003**

Prod. 6 pcs ~ 8 gr  
70x57 mm



**MA3004**

Prod. 6 pcs ~ 8 gr  
72x71 mm



LETTERS  
AND  
NUMBERS  
1 2 3 4 5 6 7 8 9



**MA3005**

lettere e numeri h30mm  
letters and numbers h30mm  
Polycarbonato - Polycarbonate  
Stampo - Mould 275x175mm



# CHOCO TAG

Stampi in plastica termoformata  
Thermoformed plastic moulds



**Mi piaci**  
**23002**  
57x20 h3mm  
12 pcs



**You & me 4ever**  
**23007**  
61x23 h3mm  
12 pcs



**Just married**  
**23008**  
87x32 h3mm  
8 pcs



**I love you**  
**23009**  
62x37 h3mm  
10 pcs



**Easter**  
**23013**  
60x33 h3mm  
10 pcs



**Mimosa**  
**23014**  
69x29 h3mm  
12 pcs



**Auguri**  
**23023**  
59x29 h3mm  
12 pcs



**Happy birthday**  
**23024**  
68x37 h3mm  
10 pcs



**Tiramisù**  
**23011**  
61x21 h3mm  
12 pcs



**Nocciola**  
**23015**  
62x22 h3mm  
12 pcs



**Caprese**  
**23018**  
63x25 h3mm  
12 pcs



**Chocolate**  
**23019**  
75x23 h3mm  
12 pcs



**Sacher**  
**23005**  
61x25 h3mm  
12 pcs



**Pistacchio**  
**23016**  
79x25 h3mm  
12 pcs



**Caffè**  
**23017**  
50x30 h3mm  
12 pcs



**Yogurt**  
**23021**  
61x30 h3mm  
12 pcs



**Keep calm and...**  
**23004**  
60x38 h3mm  
8 pcs



**For my mom**  
**23006**  
70x21 h3mm  
12 pcs



**For my dad**  
**23022**  
70x21 h3mm  
12 pcs

# CHABLON

Fogli in silicone per la produzione di decorazioni in cioccolato.  
Silicone sheets for chocolate decorations.

Size 39x29cm  
Thickness 1,5mm.



**Goccia - Drop**  
**CHASIL1**  
35x25 mm - 60 pcs



**Foglia - Leaf**  
**CHASIL2**  
35x33 mm - 48 pcs



**Cuore - Heart**  
**CHASIL3**  
35x25 mm - 48 pcs



**Butterfly**  
**CHASIL4**  
60x53 mm - 20 pcs



**Puzzle**  
**CHASIL5**  
50x78 mm - 18 pcs



**Flower**  
**CHASIL8**  
55x50 mm - 25 pcs



**Fantasy 9**  
**CHASIL9**  
102x27 mm - 18 pcs



**Fantasy 10**  
**CHASIL10**  
97x30 mm - 18 pcs



**Fantasy 12**  
**CHASIL12**  
102x18 mm - 30 pcs



**Fantasy 13**  
**CHASIL13**  
104x26 mm - 24 pcs



**Fantasy 14**  
**CHASIL14**  
99x37 mm - 24 pcs



**Foglia - Leaf**  
**CHASIL22**  
75x33 mm - 25 pcs

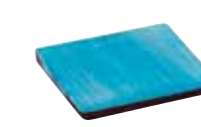

**Quadrato - Square**  
**CHASIL23**  
25x25 mm - 63 pcs

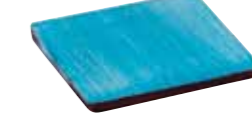

**Quadrato - Square**  
**CHASIL24**  
37,5x37,5 mm - 30 pcs



**Quadrato - Square**  
**CHASIL25**  
60x60 mm - 12 pcs



**Tondo - Round**  
**CHASIL16**  
Ø26 mm - 48 pcs

**CHASIL17**  
Ø36 mm - 36 pcs

**CHASIL18**  
Ø42 mm - 30 pcs

**CHASIL21**  
Ø20 mm - 99 pcs

**CHASIL26**  
Ø62,5 mm - 12 pcs



**Oblungo - Oblong**  
**CHASIL20**  
132x32 mm - 10 pcs

**CHASIL27**  
125x25 mm - 18 pcs

**CHASIL28**  
60x18 mm - 36 pcs



**Rettagoli - Rectangular**  
**CHASIL19**  
32x120 mm - 12 pcs



personalizzazione su richiesta  
customizable on request



# FASHION & STYLE



**Mr Chocolate**  
**200B01**  
Thermoformed plastic  
**moustache:** 117x30 h15 mm  
**glasses:** 140x50 h 10 mm  
1+1 Moulds  
Prod. 4+4 pcs ~22gr

**Mr Cigar**  
**20SI01**  
Thermoformed plastic  
125 - Ø20 mm  
2 Moulds  
Prod. 8 pcs ~40gr

# Per Lui For Him



**Mr. Papillon**  
**20PP01**  
Thermoformed plastic  
120x52 h13mm  
4 Moulds - Prod. 12 pcs ~55gr

**Soccer Ball**  
**MAC323S**  
Thermoformed plastic  
Ø120 mm  
1 Mould

**Football Boot**  
**MAC322S**  
Thermoformed plastic  
195x60 h 80 mm  
1 Mould



# Per Lei For Her



**My Sweet Bag**  
**20BA01**  
Thermoformed plastic  
119x52 h126  
2 Moulds - Prod. 2pcs ~190gr



**Eau de Chocolat**  
**20PA01**  
Thermoformed plastic  
60x31 h92mm  
4 Moulds - Prod. 4 pcs ~90gr

# FASHION & STYLE



**Lady shoe**  
**MAC326S**  
220x75 h170 mm  
Thermoformed plastic

**Chocolate Gift**  
**20PRO1**  
Thermoformed plastic  
80x80 h 69mm ~80 gr  
2 Moulds - prod: 2 pcs

**Heart**  
**MA1993**  
Polycarbonate  
33x33 h 15mm ~ 10gr  
Prod. 24 pcs



# FASHION & STYLE

Sneaker  
**MAC328S**  
100x40 h 60 mm  
Thermoformed plastic



Elegant shoe  
**30SM084**  
110x45 h105mm  
silicone mould



Baby Sneaker  
**30SM054**  
93x40 h55mm  
silicone mould



Sneaker  
**30SM083**  
135x45 h45m  
silicone mould



Women's boot  
**MAC329S**  
95x35 h75 mm  
Thermoformed plastic



Baby Sneaker  
**MAC327S**  
90x40 h35 mm  
Thermoformed plastic





*Silicone*  
Idea  
sweet creation

Stampi in silicone 3D  
3D Silicone moulds



Coccinella stesa  
Lying ladybug  
30SM042  
55x80 h85mm

Coccinella felice  
Happy ladybug  
30SM041  
60x40 h100mm

Topolino con cravatta  
Mouse with tie  
30SM032  
57x55 h90mm



Bimbo calciatore  
Footballer  
30SM044  
62x35 h105mm



Elefante  
Elephant  
30SM035  
110x70 h120mm



Ippopotamo  
Hyppo  
30SM031  
80x65 h95mm



Scoiattolo  
Squirrel  
30SM006  
80x50 h112mm



Funghetti nel bosco  
Wood mushroomms  
30SM059  
70x55 h85mm



Trio funghi  
3 mushrooms  
30SM060  
80x75 h115mm



Riccio  
Hedgehog  
30SM034  
65x70 h70mm

MINI FARM



Bimba eschimese  
Eskimo girl  
30SM056  
50x50 h80mm



Bimbo eschimese  
Eskimo boy  
30SM057  
50x50 h85mm



Bimbo con palla neve  
Snowball child  
30SM055  
60x50 h80mm



Trattore  
Tractor  
30SM069  
75x60 h67mm



Gatto mini fattoria  
Mini farm cat  
30SM065  
60x40 h55mm



Cane mini fattoria  
Mini farm dog  
30SM066  
45x45 h68mm



Mucca mini fattoria  
Mini farm cow  
30SM067  
35x40 h60mm



Maiale mini fattoria  
Mini farm pig  
30SM068  
40x50 h65mm



## OLD STYLE

*Silicone*  
Idea  
sweet creation



Scooter vintage  
Vintage scooter  
**30SM071**  
80x50 h75mm



Valigia  
Luggage  
**30SM051**  
125x60 h110mm



Macchina da cucire  
Sewing machine  
**30SM045**  
120x72 h90mm



Macchina fotografica  
Camera  
**30SM046**  
78x62 h65mm

## FOGLIE - LEAVES



**FOGLIA OVATA 01**  
**OVATE LEAF 01**  
**30SMF01**  
90x67mm  
Silicone mould



**FOGLIA OVATA 02**  
**OVATE LEAF 02**  
**30SMF02**  
85x57mm  
Silicone mould



**FOGLIA ELLITTICA 01**  
**ELLIPTICAL LEAF 01**  
**30SMF03**  
117x57mm  
Silicone mould

## MACARON



**Gusci Macaron e Vassoio**  
**Macarons shells and Tray**  
**30SMT01**  
prod. 24 gusci / shells  
Soggetti/Subjects: Ø33 h12mm  
Vassoio - Tray: 320x195mm  
Silicone mould





# THERMOFORMED MOULDS



**20-1010**  
Prod. 6 petals  
105x50 h 25 mm

**20-1011**  
Prod. 8 petals  
80x35 h 18 mm

Kit composto da 1 stampo semisfera e 4 stampi petalo.  
Kit made up of 1 hemisphere mould and 4 petal moulds.



**90-11568**  
3+3 pcs - 128 Ø26 mm



**90-1000**  
1 pcs - 210x64 mm



**90-15303**  
12 pcs - 42x19 h6mm



**90-15792**  
2 pcs - 100x90 h15mm



**90-5602**  
11 pcs - Ø29 h24



**90-5620**  
8 pcs - Ø33 h26



**90-5634**  
14 pcs - 42x26 h9



**90-5022**  
11 pcs - Ø35 h8



**90-5020**  
11 pcs - 34x20 h18



**90-13308**  
11 pcs - 38x31 h19



**90-13307**  
14 pcs - 42x19 h14



**90-5031**  
11 pcs - 34x34 h8



**90-5023**  
11 pcs - 53x25 h9



**90-5005**  
18 pcs - 29x22 h8



**90-13025**  
14 pcs - Ø33 h8



**90-13026**  
11 pcs - Ø36 h7



**90-13034**  
22 pcs - 35x23 h8



**90-13035**  
14 pcs - 46x23 h7



**90-13036**  
18 pcs - Ø25 h8



**90-13040**  
12 pcs - 35x60 h8



**90-5621**  
11 pcs - Ø30 h18



**90-13019**  
11 pcs - Ø42 h9



**90-13024**  
11 pcs - Ø37 h5



**90-13070**  
11 pcs - 44x44 h12



**90-13069**  
8 pcs 46x25 h8 10 pcs Ø26 h8



**90-13114**  
4 pcs - 166x60 h16



**90-5111**

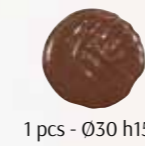

1 pcs - Ø30 h15



1 pcs - Ø30 h15

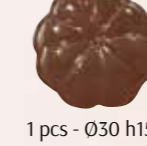

1 pcs - Ø30 h15

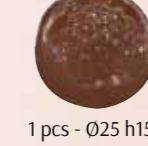

1 pcs - Ø25 h15



1 pcs - Ø30 h15



1 pcs - Ø30 h15

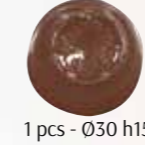

1 pcs - Ø30 h15

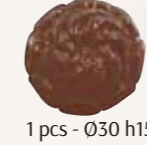

1 pcs - Ø30 h15

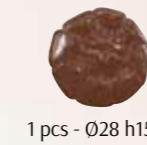

1 pcs - Ø28 h15



1 pcs - Ø30 h15

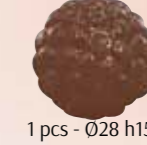

1 pcs - Ø28 h15



**90-5112**



1 pcs - 35x20 h18



1 pcs - 35x20 h18



1 pcs - 35x20 h18



1 pcs - 35x20 h18



1 pcs - 35x20 h18



1 pcs - 35x20 h18



1 pcs - 35x20 h18



1 pcs - 35x20 h18



1 pcs - 35x20 h18



1 pcs - 35x20 h18



1 pcs - 35x20 h18



**90-13326**



1 pcs - 55x30 h10



1 pcs - Ø40 h15



1 pcs - 40x40 h8



1 pcs - 52x32 h13



1 pcs - 50x30 h13



1 pcs - 40x32 h12



1 pcs - 60x35 h12



1 pcs - 60x23 h10



2 pcs - 30x50 h10





90-13062



90-5104



90-13064



90-13324



90-13453



90-15391  
2 pcs - 150x100 h12



90-15304  
8 pcs - 45x46 h14



90-6303  
3 pcs - 68x43 h18

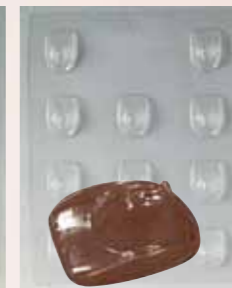

90-14613  
11 pcs - 36x27 h22



90-6008  
10 pcs - Ø36 h20



90-15362  
1 pcs - 175x63



Soccer Ball  
20-CA100  
Ø65 h 23  
4 decorations



90-6604  
1 pcs - 80x80 h14



90-6804



2 pcs  
90x52 h15



1 pcs  
50x75 h4



1 pcs  
45x35 h25



90-15331



2 pcs  
35x50 h10

2 pcs  
30x60 h10



2 pcs  
30x50 h10

2 pcs  
30x60 h10



90-15332



4 pcs  
30x37 h5

4 pcs  
25x28 h5



4 pcs  
22x23 h5

4 pcs  
30x35 h5



90-13915



1 pcs  
48x106 h6

2 pcs  
50x25 h6

2 pcs  
30x30 h6

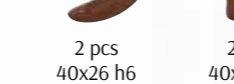

2 pcs  
40x26 h6

2 pcs  
40x20 h6

2 pcs  
30x25 h6



90-13912



2 pcs  
60x25 h8

2 pcs  
50x50 h8

2 pcs  
40x7 h2

2 pcs  
55x20 h8

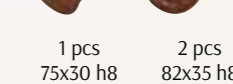

1 pcs  
75x30 h8

2 pcs  
82x35 h8

2 pcs  
75x30 h8



90-13414



4 pcs  
30x30 h4

4 pcs  
30x22 h4



4 pcs  
28x28 h4

4 pcs  
30x27 h4



90-13477



1 pcs  
99x57 h5

1 pcs  
99x57 h5

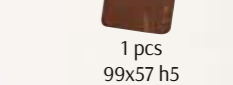

1 pcs  
99x57 h5

1 pcs  
99x57 h5





1 pcs 190x50 h7  
1 pcs 150x45 h7  
1 pcs 115x25 h7



1 pcs 115x72 h7  
1 pcs 135x50 h7

90-14687



1 pcs 95x50 h8  
1 pcs 100x40 h8  
1 pcs 113x42 h8



1 pcs 132x40 h8  
1 pcs 90x23 h8  
1 pcs 67x42 h8

90-12682



90-12840  
4+4 pcs - Ø40 h9



90-12841  
4+4 pcs - Ø35 h10



90-12869  
1+1 pcs - 100x120 h20



90-12876  
6 pcs - Ø65 h20



2 pcs 55x70 h5  
2 pcs 70x88 h5  
1 pcs 75x95 h8

90-13179



3 pcs 30x50 h8  
3 pcs 50x45 h8

3 pcs 31x48 h8  
2 pcs 42x57 h8

90-11210



3 pcs 35x30 h7  
3 pcs 47x32 h8  
3 pcs 45x32 h8

1 pcs 43x35 h8  
2 pcs 35x41 h8

90-13611

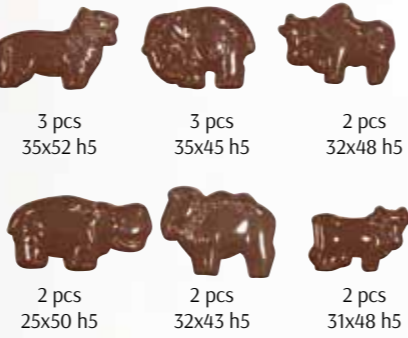

3 pcs 35x52 h5  
3 pcs 35x45 h5  
2 pcs 32x48 h5

2 pcs 25x50 h5  
2 pcs 32x43 h5  
2 pcs 31x48 h5

90-11185



2 pcs - 50x20 h8  
2 pcs - 27x27 h10  
2 pcs - 40x35 h10  
2 pcs - 53x27 h8

2 pcs - Ø42 h8  
2 pcs - 52x27 h8  
2 pcs - 35x40 h8

90-12816



10 pcs 80x35 h3mm

90-P9645



1 pcs 45x40 h5mm

90-14243



4 pcs 40x32 h8

4 pcs 30x50 h10

3 pcs 25x60 h10

90-12819

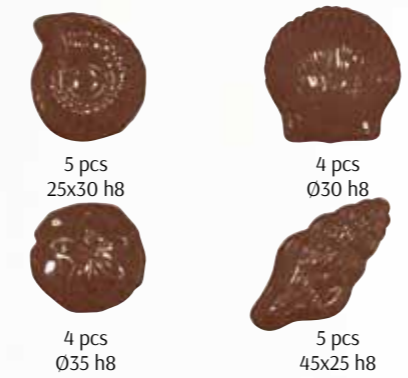

5 pcs 25x30 h8

4 pcs Ø35 h8

4 pcs Ø30 h8

5 pcs 45x25 h8

90-12817



13 pcs 50x25 h3mm

90-P9661



14 pcs 50x25 h3mm

90-P9662



90-12815  
13 pcs - 48x28 h13



90-11910  
4+4 pcs - 64x42 h8



90-11708  
8 pcs - 53x33 h14



90-9392  
1+1 pcs - 110x95 h14



90-13021  
14 pcs - 36x27 h8



90-11943  
1 pcs - 75x85 h28



90-14241



18x17 h2 mm



18x17 h2 mm



1 pcs 18x17 h2 mm



1 pcs 18x17 h2 mm



1 pcs 18x17 h2 mm



1 pcs 18x17 h2 mm



*it's Christmas time*





# Christmas Tree



**Christmas Tree**  
**20A3D01**  
Thermoformed plastic  
Ø112 h180 mm ~ 170gr  
4 Moulds - Prod. 2 pcs



**Christmas Tree**  
**20A3D02**  
Thermoformed plastic  
Ø95 h120 mm ~ 100gr  
4 Moulds - Prod. 4 pcs





# Christmas Cones

Stampi cono in plastica termoformata per realizzare alberi o pièce in cioccolato.

Thermoformed Plastic moulds to realize Christmas trees or chocolate pièce.



**Big Tree**  
**20CO02**  
Thermoformed plastic  
Ø123 h 205mm ~ 300gr  
Prod: 2 pcs



**Small Tree**  
**20CO01**  
Thermoformed plastic  
Ø83 h 140mm ~ 140gr  
Prod: 4 pcs

Cioccolato  
Chocolate

*Xmas* PUZZLE



1



2



3

**Puzzle Christmas**  
**20BC100**  
Thermoformed plastic - Conf. 3 models  
1 95x9 h 147mm ~80 gr  
2 103x9 h 150mm ~80 gr  
3 100x9 h 123mm ~80 gr

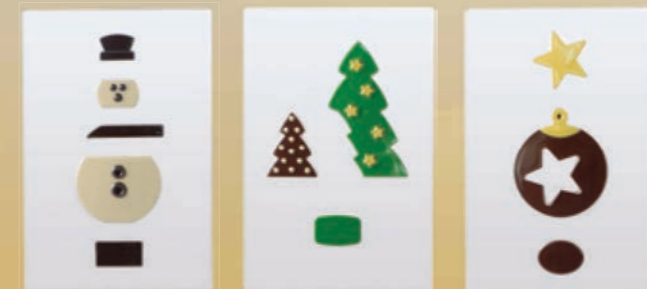



# Sweet Christmas

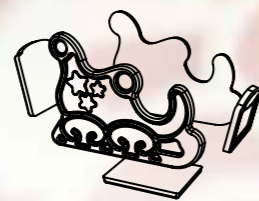

**Christmas Sledge**  
**20SL01**

Thermoformed plastic  
140x70 h 100mm ~140 gr  
2 Moulds - prod: 2 pcs



**Sweet Home**  
**20HO01**

Thermoformed plastic  
108x116 h 118mm ~280 gr  
4 Moulds - prod: 2 pcs



**Chocolate Gift**  
**20PR01**

Thermoformed plastic  
80x80 h 69mm ~80 gr  
2 Moulds - prod: 2 pcs



**Chocolate gift**  
**(Praline)**  
**MA1991**  
Polycarbonate mould  
26x26 h 20mm ~ 11gr  
prod: 28 pcs



# DECORATIONS



**Star**  
**CHASIL30**  
Chablon silicone mat  
42 pcs - Ø 34mm  
Thickness 1,5mm



**Little star**  
**CHASIL29**  
Chablon silicone mat  
60 pcs - Ø 26mm  
Thickness 1,5mm

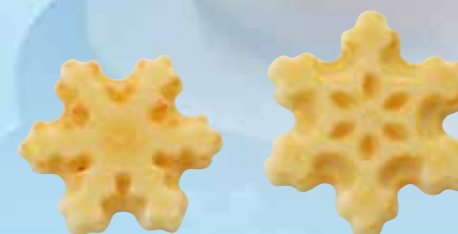

**Fiocchi di neve - Snowflakes**  
**20-D029**  
Polycarbonate mould  
14 pcs Ø30 h 4mm ~ 1gr  
12 pcs Ø40 h 4mm ~ 2gr

Stampi sfera vedi pg 29 - Sphere moulds see pg 29



# 3D CHRISTMAS

Stampi in plastica termoformata per soggetti di cioccolato con corpo cavo  
Thermoformed plastic mould for hollow for chocolate figures



**Tender bear**  
**MAC409S**  
67x54 h105mm ~ 90gr

**Surprise bear**  
**MAC408S**  
63x54 h101mm ~ 90gr



**Toy Soldier**  
**MAC407S**  
1 pc 40x34 h150mm



**Princess**  
**MAC411S**  
1 pc 72x72 h125mm

**Pandoro - Traditional Cake**  
**MAC412S**  
Ø92 h 85mm ~80 gr



**Panettone - Traditional Cake**  
**MAC413S**  
Ø77 h 85mm ~80 gr



3D CHRISTMAS



**Santa Claus**  
**MAC401S**  
Ø70 h120mm



**Snowman**  
**MAC402S**  
64x70 h110mm



**Christmas tree**  
**MAC403S**  
90x80 h120mm



**Santa Claus with fawn**  
**MAC140S**  
h180mm



**Santa Claus with gifts**  
**MAC190S**  
h170mm



**Motorcycle Santa Claus**  
**MAC200S**  
h120mm



**Candle**  
**MAC404S**  
Ø82 h128mm



**Santa Claus with teddy bear**  
**MAC170S**  
h168mm



**Santa Claus in the chimney**  
**MAC240S**  
h185 mm



**Happy Snowman**  
**MAC310S**  
h100mm  
(2 figures)



**Mr Penguin**  
**MAC300S**  
h230mm



**Santa Claus bear**  
**MAC281S**  
h180mm



**Santa Claus with lantern**  
**MAC122S**  
h140mm (4 figures)



**Santa Claus with reindeer**  
**MAC130S**  
h122 mm  
(3 figures)



**Snowman**  
**MAC320S** h114mm  
(3 figures) **MAC321S** h150mm



**Big Boot**  
**MAC421S**  
h135mm



**Nativity**  
**MAC410S**  
175x50 h115 mm



**Angel with Candle**  
**MAC000S** h80mm  
(3 figures) **MAC001S** h125mm  
(2 figures) **MAC002S** h175mm



## CHRISTMAS BAUBLES



**Decorated spheres 3**  
**20SF003**  
Thermoformed plastic  
prod. 6 pcs  
Ø 60mm ~ 40 gr



**Decorated spheres 4**  
**20SF004**  
Thermoformed plastic  
prod. 6 pcs  
Ø 60mm ~ 40 gr



**Decorated spheres 5**  
**20SF005**  
Thermoformed plastic  
prod. 6 pcs  
Ø 60mm ~ 40 gr



**Decorated spheres 6**  
**20SF006**  
Thermoformed plastic  
prod. 6 pcs  
Ø 60mm ~ 40 gr

## PRALINE



**Pandoro**  
**MA1990**  
Polycarbonate mould  
Ø30 h 25mm ~ 10gr  
prod: 24 pcs



**Chocolate gift**  
**MA1991**  
Polycarbonate mould  
26x26 h 20mm ~ 11gr  
prod: 28 pcs



**Chocolate star**  
**MA1984**  
Polycarbonate mould  
40x42 h 16mm ~ 10gr  
prod: 15 pcs



**Small Elves**  
**MA1973**  
Polycarbonate mould  
30x24 h 20mm ~ 7gr  
prod: 5x6 pcs



**Small Christmas Sphere**  
**MA1974**  
Polycarbonate mould  
30x26 h 16,5mm ~ 7gr  
prod: 5x6 pcs



**Small Christmas Tree**  
**MA1975**  
Polycarbonate mould  
31x22 h 22mm ~ 7gr  
prod: 5x5 pcs

## CHOCO TAG



**Buone Feste tag**  
**23026**  
Thermoformed plastic  
52x54 h2mm  
8 pcs



**Merry Christmas tag**  
**23025**  
Thermoformed plastic  
66x52 h2mm  
8 pcs



# 3D POLYCARBONATE

Polycarbonato - Polycarbonate  
Stampo - Mould: 275x175 mm



### Tree & Candle

**20-C1009**

Prod. 4+4 pcs  
Tree: 53x45 h71 mm  
Candle: Ø49 h76 mm

### Santa & Snowman

**20-C1010**

Prod. 4+4 pcs  
Santa Claus: Ø46 h79 mm  
Snowman: 42x46 h72 mm

### Reindeer

**20-C1001**

Prod.4 pcs  
43x43 h120 mm ~ 65 gr

### Reindeer

**20-C1002**

Prod.4 pcs  
46x45 h100 mm ~ 68 gr



### Tree

**20-C1000**

Prod.5 pcs  
Ø58 h 100 mm~ 100 gr



### Dad Squirrel

**20-C1003**

Prod.2 pcs  
92x51 h120 mm ~ 118 gr



### Mum Squirrel

**20-C1004**

Prod.4 pcs  
103x40 h80 mm ~ 55 gr



### Baby Squirrel

**20-C1005**

Prod.6 pcs  
68x32 h64 mm ~ 32 gr

# Lollipop



### Chocolate lollipop moulds

**20L005**

Thermoformed plastic  
Albero - Tree: 70x76 h9 mm ~34 gr  
Stella - Star: 77x74 h9 mm ~ 31 gr  
Prod. 8 pcs



*Silicone*  
**Idea**  
sweet creation

### Chocolate lollipop moulds

**30SML002**

Silicone mould  
Prod.5 pcs  
Tray included: 395x143mm

70x80mm

75x85mm

70x85mm

80x80mm

60x85mm

### Chocolate lollipop moulds

**20-C024**

Rigid plastic mould  
Prod.6 pcs  
60x70 mm ~ 30gr







**Renna con cuore**  
Reindeer with heart  
**30SM001**  
85x40 h117mm



**Orsetto Babbo Natale**  
Santa Claus bear  
**30SM002**  
80x70 h135mm



**Pupazzo con sciarpa**  
Snowman with scarf  
**30SM008**  
105x95 h125mm



**Renna simpatica**  
Funny reindeer  
**30SM009**  
65x80 h100mm



**Angioletto con stella**  
Angel and star  
**30SM058**  
65x45 h80mm



**Pupazzo con lanterna**  
Snowman with lantern  
**30SM004**  
90x75 h130mm



**Babbo Natale**  
Santa Claus  
**30SM003**  
60x65 h130mm



**Babbo Natale gnomo**  
Santa Claus gnome  
**30SM007**  
125x75 h115mm



**Angioletto con libro**  
Angel with book  
**30SM010**  
80x60 h105mm



**Angelo con cornetta**  
Angel with trumpet  
**30SM018**  
90x75 h130mm



**Angelo con cometa**  
Angel with comet  
**30SM087**  
110x40 h70mm



**Sacra famiglia  
Nativity**  
**30SM077**  
Kit 5 stampi - Set 5 moulds



**Asinello  
Donkey**  
**30SM076**  
70x40 h68mm

**Gesù bambino  
Baby Jesus**  
**30SM072**  
75x55 h30mm

**Bue  
Ox**  
**30SM075**  
75x40 h68mm

**Maria  
Holy Mary**  
**30SM074**  
50x47 h88mm

**San Giuseppe  
Saint Joseph**  
**30SM073**  
65x55 h110mm



**Presepe  
Nativity**  
**30SM017**  
150x75 h120mm

MINI



**Mini candela di Natale  
Mini Christmas candle**  
**30SM079**  
55x40 h65mm



**Mini Babbo nel camino  
Mini Santa in chimney**  
**30SM080**  
60x32 h70mm



**Mini calza befana  
Mini Christmas stocking**  
**30SM081**  
55x40 h65mm



**Mini pupazzo di neve  
Mini snowman**  
**30SM082**  
55x40 h65mm

DECORATIONS



**30SMA001**  
55x85x15mm



**30SMA002**  
55x85x15mm



**30SMA004**  
55x85x15mm



**30SMA007**  
Ø60 h75mm



**30SMA008**  
Ø60 h75mm



**30SMA009**  
85x95x20mm



**30SMA011**  
65x88x20mm



# THERMOFORMED MOULDS

**Paesaggi di Natale**  
**Christmas landscapes**

**20-S1010**

Kit 3 moulds  
Prod. 3 pcs  
h 110 mm



**90-4103**



**90-4105**



**90-4110**



**90-4108**



**90-4109**



**90-4102**



**90-4307**

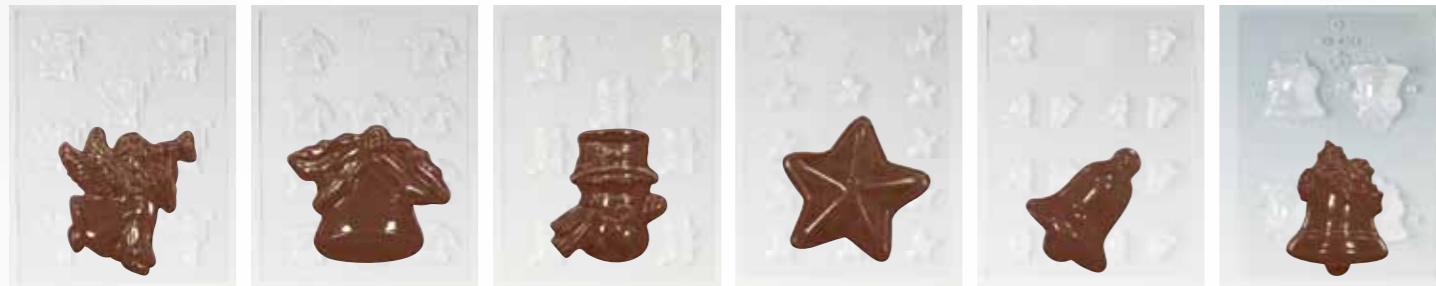
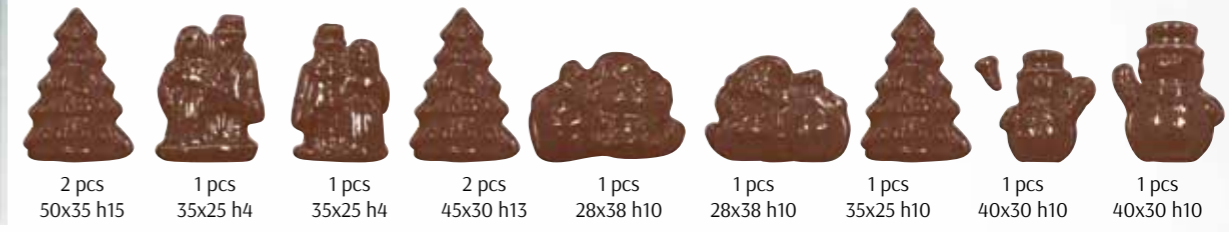

**90-4015**

8 pcs - 46x48 h5mm

**90-4017**

11 pcs - 45x40 h8mm

**90-4020**

8 pcs - 40x47 h10

**90-4060**

14 pcs - Ø30 h11

**90-4061**

14 pcs - 32x25 h14

**90-4301**

2+2 pcs - 59x42 h25



**90-4010**

11 pcs - 50x27 h4

**90-4013**

8 pcs - 40x60 h10

**90-4303**

1 pcs - 104x58

**90-4314**

2 pcs - 90x80 h37mm

**90-4059**

18 pcs - Ø30 h8mm

**90-4021**

8 pcs - 42x48 h10mm

**90-4016**

8 pcs - 45x45 h14mm

**90-4107**

mix

2 pcs 50x40 h7  
3 pcs 35x42 h7

3 pcs Ø35 h7  
3 pcs 45x32 h7



**Santa - Double**

**90-4406**

1 pcs - 250x160 h75 mm

**Scarpone - Double**

**90-4401**

1 pcs - 140x130 h45 mm



*Happy  
Easter*





# Prestige Easter



**20U3D05**

Thermoformed plastic  
Prod. 2 uova/eggs  
Ø115 h 185 mm  
~ 310 gr



**20U3D03**

Thermoformed plastic  
Prod. 2 uova/eggs  
Ø120 h 185 mm  
~ 300 gr

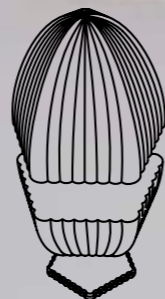

**20U3D04**

Thermoformed plastic  
Prod. 2 uova/eggs  
Ø122 h 185 mm  
~ 270 gr

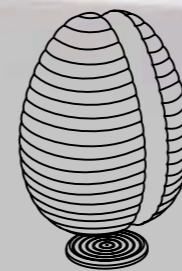

**20U3D02**

Thermoformed plastic  
Prod. 2 uova/eggs  
Ø115 h 185 mm  
~ 320 gr





# Prestige Easter

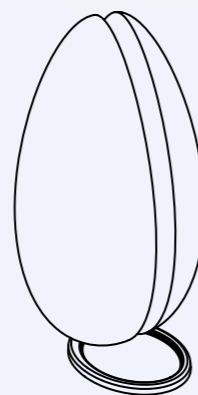

**NEW**  
**20U3D01**  
Thermoformed plastic  
Prod. 2 uova/eggs  
Ø110 h 220 mm  
~ 230 gr

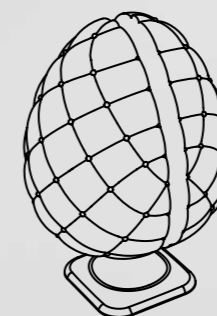

**NEW**  
**20U3D06**  
Thermoformed plastic  
Prod. 2 uova/eggs  
Ø115 h 155 mm  
~ 230 gr



# PUZZLE EGGS



## 20UB100

Thermoformed plastic - Conf. 3 models  
 1 107x82 h 158mm ~160 gr  
 2 110x58 h 165mm ~160 gr  
 3 104x52 h 150mm ~140 gr

# Origami Easter



## 20OR001

Thermoformed plastic - Conf. 3 models  
 Pulcino - Chick 113x42 h132 mm ~100 gr  
 Pecora - Sheep 100x45 h100 mm ~90 gr  
 Coniglio - Bunny 76x42 h142 mm ~60 gr





# 3D EASTER

Stampi in plastica termoformata per soggetti di cioccolato con corpo cavo  
Thermoformed plastic mould for hollow for chocolate figures



**Duck**  
**MAC611S**  
70x70 h120mm  
~110 gr

**Little Bunny**  
**MAC614S**  
Ø60 h140mm  
~85 gr

**Chicken**  
**MAC612S**  
70x70 h130mm  
~110 gr

**Bunny**  
**MAC613S**  
Ø80 h120mm  
~110 gr

**NEW**  
**Mr. Bunny**  
**MAC616S**  
90x60 h152 mm  
~ 100 gr

**NEW**  
**Ms Cocodé**  
**MAC615S**  
108x75 h120 mm  
~ 90 gr







**Pulcino Chick**  
**MAC602S**  
 160x120 h210mm  
 ~ 460 gr

**Coniglio Rabbit**  
**MAC604S**  
 120x120 h220mm  
 ~ 480 gr

**Pecorella Sheep**  
**MAC603S**  
 140x120 h190mm  
 ~ 310 gr



**Bunny with stroller**  
**MAC661S**  
 h140 mm



**Bunny and Duck**  
**MAC670S**  
 h195 mm



**Three friends**  
**MAC740S**  
 h220 mm



**Hug in egg**  
**MAC720S**  
 h170 mm  
 (2 figures)



**Baby Bunny**  
**MAC620S**  
 h180 mm



**Bunny in Love**  
**MAC630S**  
 h235 mm



**Three in a basket**  
**MAC610S**  
 h170 mm



**Bunny and big egg**  
**MAC760S**  
 h150 mm



**Small Bell**  
**MAC950S**  
 h110 mm

**Big Bell**  
**MAC952S**  
 h140 mm





**Small Chicken**  
**MAC822S**  
h110 mm

**Big Chicken**  
**MAC823S**  
h160 mm



**Baby Chick**  
**MAC870S**  
h110 mm  
(3 figures)



**Baby Goose**  
**MAC880S**  
h145 mm



**Nice Chicken (small)**  
**MAC800S**  
h160 mm  
(2 figures)

**(big)**  
**MAC801S**  
h205 mm



**Mrs Goose**  
**MAC850S**  
h125 mm  
(2 figures)



**Mr Goose**  
**MAC860S**  
h125 mm  
(2 figures)



**Nice Duck**  
**MAC920S**  
h97 mm  
(2 figures)



## 3D POLYCARBONATE

Polycarbonato - Polycarbonate  
Stampo - Mould: 275x175 mm



**Gallo - Rooster**  
**20-C1955**  
Prod.2 pcs  
100x160 h126 mm ~ 115 gr



**Gallina - Hen**  
**20-C1956**  
Prod.4 pcs  
94x108 h106 mm ~ 75 gr



**Pulcino - Chick**  
**20-C1957**  
Prod.6 pcs  
65x84 h80 mm ~ 45 gr



**Elefante Papà - Dad Elephant**  
**20-C1006**  
Prod.2 pcs  
123x64 h81 mm ~ 128 gr



**Elefante Mamma - Mum Elephant**  
**20-C1007**  
Prod.4 pcs  
113x62 h62 mm ~ 87 gr



**Elefante Bebè - Baby Elephant**  
**20-C1008**  
Prod.6 pcs  
81x43 h53 mm ~ 36 gr



# THERMOFORMED MOULDS



## Paesaggi di Pasqua Easter landscapes

**20-S2010**

Kit 3 moulds  
Prod. 3 pcs  
h 110 mm



**90-2104**

4 pcs  
60x38 h15



4 pcs  
43x60 h10



4 pcs  
57x27 h15



**90-2119**

10 pcs  
22x14 h6



10 pcs  
20x15 h6



10 pcs  
28x15 h6



10 pcs  
20x23 h6



**90-2117**

1 pcs  
48x38 h7



2 pcs  
52x32 h7



4 pcs  
35x40 h7



3 pcs  
48x28 h7



1 pcs  
52x30 h7



**90-2114**

4 pcs  
40x22 h10



4 pcs  
35x30 h10



4 pcs  
36x36 h10



4 pcs  
36x24 h10



**90-2339**  
1 pcs - 150x90 h21



**90-2342**  
1 pcs - 74x122 h18



**90-2345**  
1 pcs - 105x86 h26



**90-2102**

3 pcs  
43x40 h12



4 pcs  
40x35 h11



4 pcs  
40x35 h17



3 pcs  
48x35 h8



**90-2014**  
12 pcs - 37x48 h6 mm

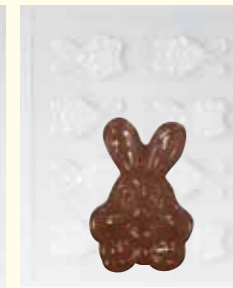

**90-2020**  
8 pcs - 65x41 h14 mm



**90-2021**  
8 pcs - 65x41 h14



**90-2033**  
14 pcs - 34x27 h10



**90-2034**  
9+9 pcs - 30x32 h6

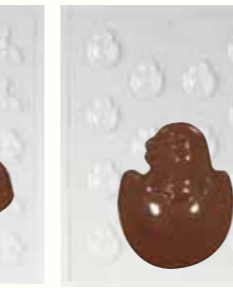

**90-2035**  
18 pcs - 35x27 h10



**90-2330**  
3+3 pcs - 54x54 h16



**90-2333**  
1 pcs - 150x78 h40



**90-2346**  
1 pcs - 150x64 h25



**90-2302**  
3+3 pcs - 60x50 h26



**90-2305**  
1 pcs - 112x95 h20



**90-2314**  
1 pcs - 170x60 h34

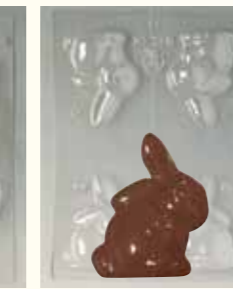

**90-2316**  
2 pcs - 79x58 h12

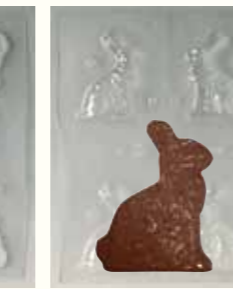

**90-2318**  
2+2 pcs - 79x58 h13



**90-2320**  
3+3 pcs - 60x65 h15



**90-2349**  
1 pcs - 84x78 h27



**90-11907**  
6+6 pcs - 40x30 h5



**90-2025**  
11 pcs - 42x30 h14







**Uovo con paperotto**

**Egg with gosling**

**30SMG01**

Silicone mould  
Ø110 h175mm  
Supporto per Guscio non incluso  
Shell holder not included

**Uovo con fiori di pesco**

**Egg with peach flowers**

**30SMG03**

Silicone mould  
Ø110 h175mm  
Supporto per Guscio non incluso  
Shell holder not included



**Supporto in plastica per guscio**

**Plastic shell holder**

**30SMS00**

2 pcs  
Silicone non incluso  
Silicone not included





Gallina con uovo verticale  
Chicken and vertical egg  
**30SM024**  
85X75 h125mm



Gallina con uovo orizzontale  
Chicken and horizontal egg  
**30SM025**  
100X77 h125mm



Coniglio con carriola  
Rabbit and wheelbarrow  
**30SM022**  
105x55 h120mm



Pecora con vestitino  
Sheep with dress  
**30SM020**  
80x65 h110mm



Pecora con maglietta  
Sheep with shirt  
**30SM021**  
80x60 h115mm



Big pecora con fiore  
Big sheep and flower  
**30SM028**  
80x75 h130mm



Coniglio con carota  
Rabbit and carrot  
**30SM023**  
100X80 h140mm



Coniglio con uovo pasquale  
Rabbit and easter egg  
**30SM026**  
77x80 h120mm



coniglio con ovetto  
Rabbit and small egg  
**30SM027**  
55x65 h110mm

Pecora con salopette  
Sheep in overall  
**30SM029**  
75x60 h125mm

Pecora con bebè  
Sheep with baby  
**30SM030**  
70x70 h125mm



*Silicone*  
**Idea**  
sweet creation



# EGGS MOULDS



Stampi uova sezionate  
Sectioned eggs moulds



**20-U1010**  
h110 mm ~ 100 gr



**20-U1011**  
h180 mm ~ 250 gr



Stampo mezzo guscio in plastica rigida (PETG).  
Half shell mould made of strong plastic material (PETG).

~ Kg	Misure mm	Code	1,5 - 2	325x240	SUT34X25	4 - 6	520x350	SUT54X36
0,5 - 1	250x170	SUT25X17	2 - 2,5	390x265	SUT40X27	6 - 8	620x420	SUT64X43
0,8 - 1,2	280x185	SUT28X18	2,5 - 3,5	435x310	SUT45X32	8 - 10	740x490	SUT75X50

## SMOOTH HALF EGG

Stampi in polietilene MEZZO GUSCIO  
HALF EGG polyethylene moulds



**SM2500**  
2 pcs - 125x94 h44 mm



**SM3000**  
2 pcs - 140x100 h50 mm



**SM3500**  
2 pcs - 154x110 h55 mm



**SM4000**  
1 pcs - 220x160 h85 mm



**SM2000**  
2 pcs - 110x80 h40 mm



**Double SM2300**  
2 pcs - 112x83 h44 mm



**90-2008**  
18 pcs - 36x23 h12 mm



**90-2010**  
14 pcs - 40x31 h17 mm



**90-2026**  
18 pcs - 25x35 h12 mm



**SM1000**  
4 pcs - 80x60 h25 mm

## CRACK HALF EGG



**90-2009**  
14 pcs - 39x25 h13 mm



**90-2353**  
6 pcs - 64x44 h26 mm



**90-2354**  
4 pcs - 83x54 h24 mm



**2 moulds 90-2355**  
2 pcs - 96x70 h40 mm



**2 moulds 90-2356**  
1 pcs - 140x100 h49 mm



## HALF EGG MOULDS

Stampi policarbonato  
Polycarbonate moulds  
Misura - Size: 175x275 mm

**20U032N** 22x32 mm  
7gr  
prod. 32 mezzi/half

**20U064N** 44x64 mm  
25gr  
prod. 10 mezzi/half

**20U105N** 72x105 mm  
70gr  
prod. 4 mezzi/half

**20U130N** 90x130 mm  
150gr  
prod. 2 mezzi/half

**20U150N** 104x150 mm  
230gr  
prod. 2 mezzi/half

**20U175N** 121x175 mm  
260gr  
prod. 1 mezzo/half

**20U204N** 141x204 mm  
380gr  
prod. 1 mezzo/half

**20U227N** 157x227 mm  
430gr  
prod. 1 mezzo/half

**20U258** 258x175 mm  
500gr  
prod. 1 mezzo/half

**20U320** 320x210 mm  
850 gr  
prod. 1 mezzo/half



Disponibili con piastre magnetiche per macchina rotativa  
Available with magnetic plate for rotating machine

## EGGS HOLDER



Stampi cioccolato per supporto uova di Pasqua  
Chocolate moulds for Easter eggs holder

**20-CU001**  
Set 3 pcs  
36,5x36,5 h9 mm - 12 pcs  
40,5x40,5 h12 mm - 9 pcs  
52,7x52,7 h12 mm - 6 pcs



Vasetto in plastica porta uovo  
Plastic egg holders

**21VA085**  
Ø85 h70 mm  
Conf. 58 pcs

**21VA102**  
Ø102 h88 mm  
Conf. 40 pcs

## ANIMATED EGG

Kit stampi componenti per realizzare soggetti 3D  
Components mould kit to realize 3D objects

**20SC01**  
Conf. 3 pcs  
Non inclusi uova e sfere per corpo  
Eggs and sphere for body not included



**Pesce - Fish**  
184x112 h143mm  
Realizzato con uovo - Made with egg:  
Cod. 20U150N



**Gallina - Chicken**  
137x124 h173mm  
Realizzato con uovo - Made with egg:  
Cod. 20U150N - 20U064N



**Pulcino - Chick**  
100x94 h177mm  
Realizzato con uovo - Made with egg:  
Cod. 20U105N - 20U064N - 20SF002



# Valentine's Day



**Cofanetto bocciolo di rosa**  
Rose dub case  
**30SM049**  
Ø73 h60mm  
Silicone mould



**Cofanetto cuore con rose**  
Heart with roses case  
**30SM050**  
95x90 h50mm  
Silicone mould



**NEW**  
**Big heart**  
**MA1996**  
6 pcs 75x70 h 22mm  
polycarbonate moulds



**NEW**  
**Heart**  
**MA1995**  
12pcs - 45x42 h 16mm  
polycarbonate moulds



**Penguin in love**  
**30SM039**  
55x45 h80mm  
Silicone mould



**Penguins in love**  
**30SM040**  
85x50 h80mm  
Silicone mould





# Valentine's Day



**Lollipop**  
**20L004**  
Thermoformed plastic  
68x65 h9 mm ~ 34 gr  
Prod. 8 pcs



**30SML003**  
Silicone mould  
Tray included: 395x143mm

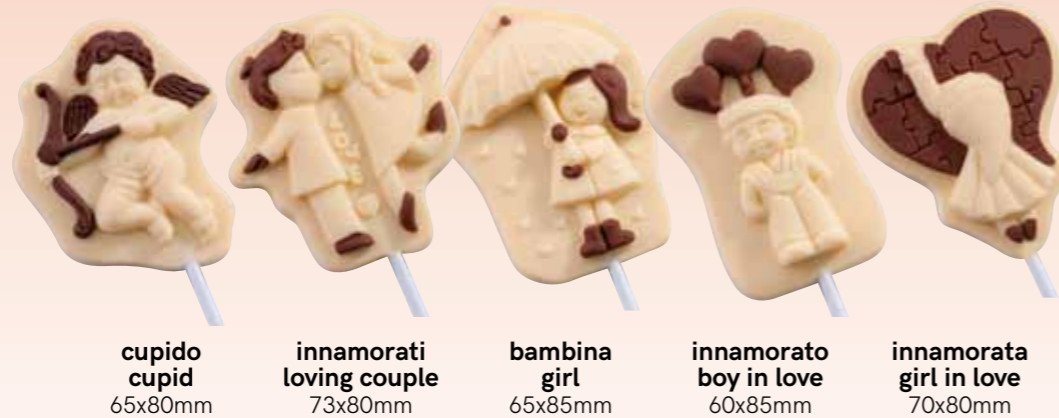

**cupido cupid** 65x80mm  
**innamorati loving couple** 73x80mm  
**bambina girl** 65x85mm  
**innamorato boy in love** 60x85mm  
**innamorata girl in love** 70x80mm



**Mi piaci**  
**23002**  
57x20 h3mm  
12 pcs



**You & me 4ever**  
**23007**  
61x23 h3mm  
12 pcs



**Just married**  
**23008**  
87x32 h3mm  
8 pcs



**I love you**  
**23009**  
62x37 h3mm  
10 pcs

## PRALINE



**MA1993**  
24 pcs - 33x33 h 15mm  
~ 10gr



**MA1513**  
28 pcs - 34x33 h11mm  
~ 7 gr



**MA1526**  
35 pcs - 34,7x22 h16mm  
~ 8 gr



**MA1613**  
15 pcs - 40x42 h15mm  
~9 gr



**MA1962**  
30 pcs - 31x27 h14mm  
~8 gr

## THERMOFORMED MOULDS



**90-1612**  
1 pcs - 155x160 h32



**90-15507**  
4+5 pcs - 57x35 h8



**90-1001**  
18 pcs - Ø23 h9



**90-1002**  
18 pcs - 33x33 h7



**90-1004**  
18 pcs - Ø33 h9



**90-1005**  
14 pcs - 29x29 h14



**90-1007**  
11 pcs - 35x37 h9



**90-1015**  
11 pcs - 43x30 h9



**90-1016**  
22 pcs - 23x19 h6



**90-1018**  
14 pcs - Ø23 h5



**90-1021**  
11 pcs - 44x32 h7



**90-1024**  
14 pcs - Ø27 h7



**90-1025**  
12 pcs - 42x38 h10



**90-1026**  
8 pcs - 52x42 h12



**90-1027**  
14 pcs - 32x27 h6



**90-1044**  
11 pcs - 45x35 h18



**90-1202**  
6 pcs - 145x50 h12



**90-1204**  
3+3 pcs - 145x40 h20



**90-1212**  
3 pcs - 152x78 h8



**90-1608**  
3 pcs - 80x77 h12



# CARNIVAL

Con gli stampi per maschere di cioccolato è possibile realizzare in modo facile e veloce dei soggetti eleganti e tradizionali che evocano l'atmosfera criptica del teatro o il giocoso mondo del carnevale veneziano.

Thanks to the moulds for chocolate masks you can easily and quickly make elegant and traditional figures that bring to mind a cryptic theatre atmosphere or the playful world of Venetian carnival.

Plastica termoformata  
Thermoformed plastic



**20-CA001**  
125x175x40 mm - prod. 1 pc



**20-CA002**  
135x175x40 mm - prod. 1 pc



**20-CA003**  
155x190x40 mm - prod. 1 pc



**20-CA004**  
130x130x60 mm - prod. 1 pc



**20-CA005**  
135x160x45 mm - prod. 1 pc



**20-CA006**  
130x180x60 mm - prod. 1 pc



**20-CA007**  
85x85x45 mm - prod. 1 pc  
80x90x70 mm - prod. 1 pc



**20-CA008**  
130x105x35 mm - prod. 1 pc



**20-CA009**  
105x135x40 mm - prod. 1 pc



**20-CA010**  
30x45x15 mm - prod. 9 pcs



**20-CA011**  
50x65x20 mm - prod. 5 pcs



**20-CA012**  
60x85x35 mm - prod. 2 pcs  
65x90x30 mm - prod. 2 pcs



**CARNEVAL1**



**CARNEVAL2**





# Halloween



**Little Pumpkin (Praline)**  
**MA1992**  
 Polycarbonate mould  
 34x31 h 15mm ~ 9+9gr  
 Prod. 12+12 pcs



**3D Pumpkin**  
**MAC324S** 90-3301  
 52x54 h 132mm ~140gr thermoformed plastic polyethylene



**Big Pumpkin**  
**MAC325S**  
 140x140 h150 mm thermoformed plastic



**Mr Pumpkin** **Black cat**  
**MAC406S** **MAC405S**  
 95x90 h110 mm 78x56 h140 mm

**20-C1011**  
 Polycarbonate moulds with magnets  
 Black Cat: 57x40 h102 mm - 2 pcs  
 Mr. Pumpkin: 38x40 h96 mm - 2 pcs



**Pumpkin & Skull Lollipops**  
**20L006**  
 Thermoformed plastic - Prod. 8 pcs  
 Zucca - Pumpkin: 69x70 h9 mm ~33gr - 4 pcs  
 Teschio - Skull: 53x70 h9 mm ~32gr - 4 pcs

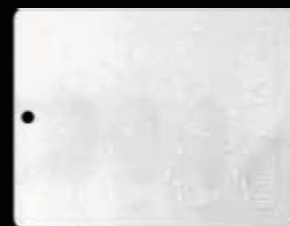

**Halloween tag**  
**23027**  
 Thermoformed plastic  
 64x37 h2mm - Prod. 8 pcs





# Silicone Idea

sweet creation

Stampi in silicone 3D  
3D Silicone moulds

**Skeleton and coffin**  
**30SM070**  
80X65 h73mm



**Owl**  
**30SM005**  
77X55 h130mm



**Halloween skull**  
**30SM086**  
95X80 h100mm



**Skeleton with coat**  
**30SM013**  
75X55 h100mm



**Frankenstein**  
**30SM016**  
75X50 h90mm



**Pumpkin with cat**  
**30SM014**  
85X70 h85mm



**Dracula**  
**30SM015**  
55X50 h85mm



**Vampire**  
**30SM019**  
120X55 h95mm



**Mini owl**  
**30SM061**  
45X37 h65mm



**Mini pumpkin**  
**30SM062**  
40X38 h65mm



**Mini witch**  
**30SM063**  
50X35 h70mm



**Mini ghost**  
**30SM064**  
70X38 h68mm



**30SML001**  
Silicone mould  
Tray included: 395x143mm



**Bat**  
72X60mm



**Pumpkin with cat**  
52X70mm



**Gost**  
65X65mm



**Witch**  
45X70mm



**Mummy**  
65X65mm



Sposi stilizzati grandi  
Big stylized married couple  
30SMW01  
80x35 h140mm



Sposi stilizzati piccoli  
Small stylized married couple  
30SMW02  
45x35 h120mm



Targa sposi  
Married couple plate  
30SMW04  
115x127 h20mm



Sposi simpatici  
Happy couple in the car  
30SMW03  
145x80 h120mm



Wedding 1  
30SMTP01  
260x85 h 310mm  
Spessore - Thickness: 9mm



Wedding 2  
30SMTP02  
210x85 h 250mm  
Spessore - Thickness: 9mm



Wedding 3  
30SMTP03  
250x85 h285 mm  
Spessore - Thickness: 9mm





# New Born Piece

**Silicone**  
Idea  
sweet creation

Cicogna con bebè  
White stork with baby  
**30SM033**  
120x75 h115mm



**NEW**  
Baptism  
**30SMTPO4**  
Misure - Size: 300x400mm  
Spessore - Thickness: 9mm



145x80 h 125mm



130x65 h 130mm

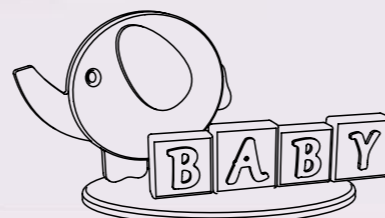

145x80 h 95mm



Bimbo su conchiglia  
Child on shell  
**30SM085**  
105x65 h30mm



Bebè che dorme  
Sleeping baby  
**30SM011**  
90x50 h30mm

Cuscino  
Pillow  
**30SM012**  
112x75 h30mm



Orsetto con ciuccio  
Little bear with pacifier  
**30SM036**  
65x60 h80mm





**Pergamena comunione**  
Parchment communion  
**30SM043**  
150x100 h25mm

**Pergamena cresima**  
Parchment confirmation  
**30SM037**  
100x150 h25mm



**Libro**  
Book  
**30SM038**  
145x100 h20mm



**Civetta laureato**  
Graduate owl  
**30SM047**  
65x60 h85mm

# Holy Piece



165x90 h 140mm

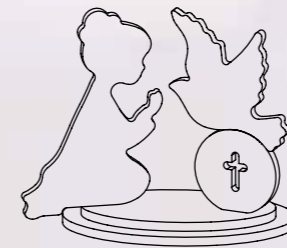

175x90 h 145mm



170x90 h 143mm



**NEW**  
**Communion and Confirmation**  
**30SMTP05**  
Misure - Size: 300x400mm  
Spessore - Thickness: 9mm



# CHOCO TOOLS



- 1
- 2
- 3
- 4
- 5
- 6
- 7
- 8
- 9
- 10

## Forchette Steel forks set

### CHOCOFORK

Set 10 pcs  
In filo di acciaio inox con manico in plastica.  
Stainless steel wire with plastic handle.

## Acquistabili anche separatamente also purchasable separately

Description	nr	Code	Description	nr	Code
2 rebbi / 2 tines	1	CHOC0101	Ø20mm	6	CHOC0105
3 rebbi / 3 tines	2	CHOC0102	Ø18mm	7	CHOC0108
4 rebbi / 4 tines	3	CHOC0103	Ø16mm	8	CHOC0109
spirale / spiral	4	CHOC0106	Ø14mm	9	CHOC0104
goccia / drop	5	CHOC0107	triangolo / triangle	10	CHOC0110

## Kit fogli in plastica trasparente Transparent plastic sheets kit

### MACLO1

360x340 mm  
Per la realizzazione di decorazioni di cioccolato in rilievo, fantasie varie.  
For the production of chocolate decorations in relief, different patterns.

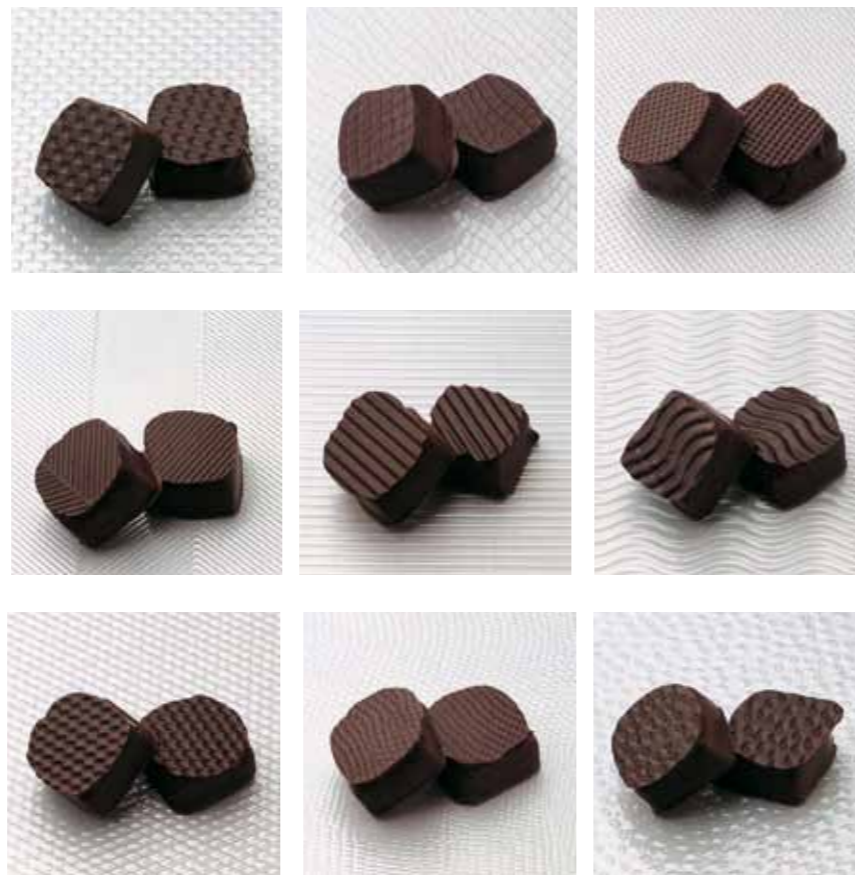

Bobina da 15 metri  
15m roll



**22BOX85**  
base 85x85 mm

**22BOX60**  
base 60x60 mm

**22BOX48**  
base 48x48 mm

Metti in mostra il lato che preferisci: abbinare al tuo Mart Box uno dei seguenti coperchi double-face.  
Show the favourite side: match your Mart Box with one of the following double-face cover.

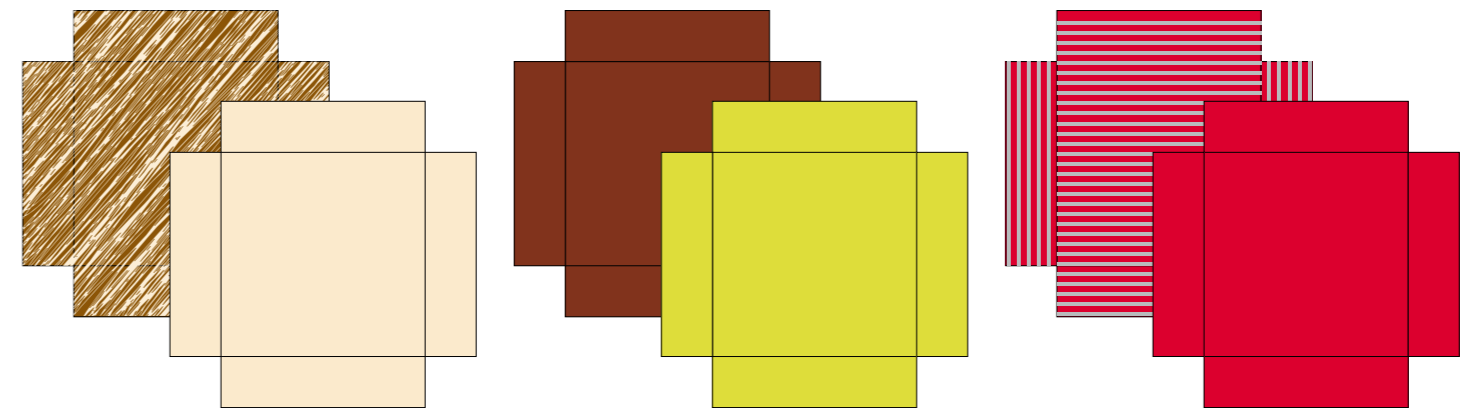

lato beige / lato fantasia  
beige side / fantasy side

lato verde / lato marrone  
green side / brown side

lato rosso / lato righe  
red side / lines side

Misure mm	pcs	Code
48x48	100	22BOX48T1
60x60	100	22BOX60T1
85x85	100	22BOX85T1

Misure mm	pcs	Code
48x48	100	22BOX48T2
60x60	100	22BOX60T2
85x85	100	22BOX85T2

Misure mm	pcs	Code
48x48	100	22BOX48T3
60x60	100	22BOX60T3
85x85	100	22BOX85T3



# PLEXIGLASS DISPLAYS



**Vetrina - Showcase**  
**VP00101**  
 60x36cm - h16cm  
 Accessori interni non inclusi  
 Internal accessories not included



**Vassoio - Tray**  
**VP00401**  
 34X11cm - h2cm



**Vassoio - Tray**  
**VP00700**  
 18X29cm - h2,5cm

**Piatto - Plate**  
**VP00801**  
 13X24cm - h0,2cm



**Vassoio - Tray**  
**VP00500**  
 32x20cm - h2,5cm



**Piatto - Plate**  
**VP00601**  
 20x15cm - h0,2cm



**Vassoio - Tray**  
**VP00206**  
 17x17cm - h2cm

**Piatto - Plate**  
**VP00301**  
 16,5x16,5cm - h0,2cm

**Vassoio - Tray**  
**VP01106**  
 17x23cm - h2cm

**Piatto - Plate**  
**VP01201**  
 16,5x22,5cm - h0,2cm



**Vassoio - Tray**  
**VP00906**  
 10x50cm - h2cm

**Piatto - Plate**  
**VP01001**  
 9,5x49,5cm - h0,2cm

**Alzatina in Plexiglass**  
**Plexiglass display**

**COD. 604**  
 22x27 h30cm



**ET001**  
 297x295 h 400mm  
 double



**ET003**  
 310x200 h 400mm



**ET004B**  
 315x410 h 370mm



**ET006**  
 305x190 h 470mm



**ET004**  
 245x300 h 290mm

## PACKAGING



Scatole trasparenti - alveoli trasparenti  
 Transparent boxes - transparent cavities  
 25 pcs



Bordo satinato - alveoli trasparenti  
 Glazed glim boxes - transparent cavities  
 25 pcs

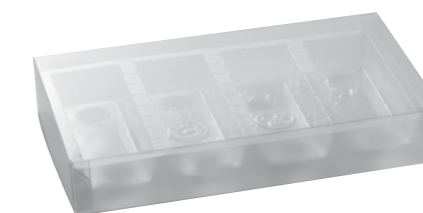

Scatola satinata - binari trasparenti  
 Glazed boxes - transparent lines and lids  
 25 pcs

Misure mm	Alveoli	Alveoli mm	Code
160x40 h20	5	32x27	<b>MSC001</b>
110x100 h20	9	32x27	<b>MSC002</b>
220x65 h20	12	32x27	<b>MSC003</b>
160x150 h20	20	32x27	<b>MSC004</b>

Misure mm	Alveoli	Alveoli mm	Code
100x115 h23	6	32x27	<b>MSC201</b>
210x100 h23	12	32x27	<b>MSC202</b>
210x100 h23	18	32x27	<b>MSC203</b>

Misure mm	Binari Lines	Code
200x120 h35	4	<b>MSC501</b>



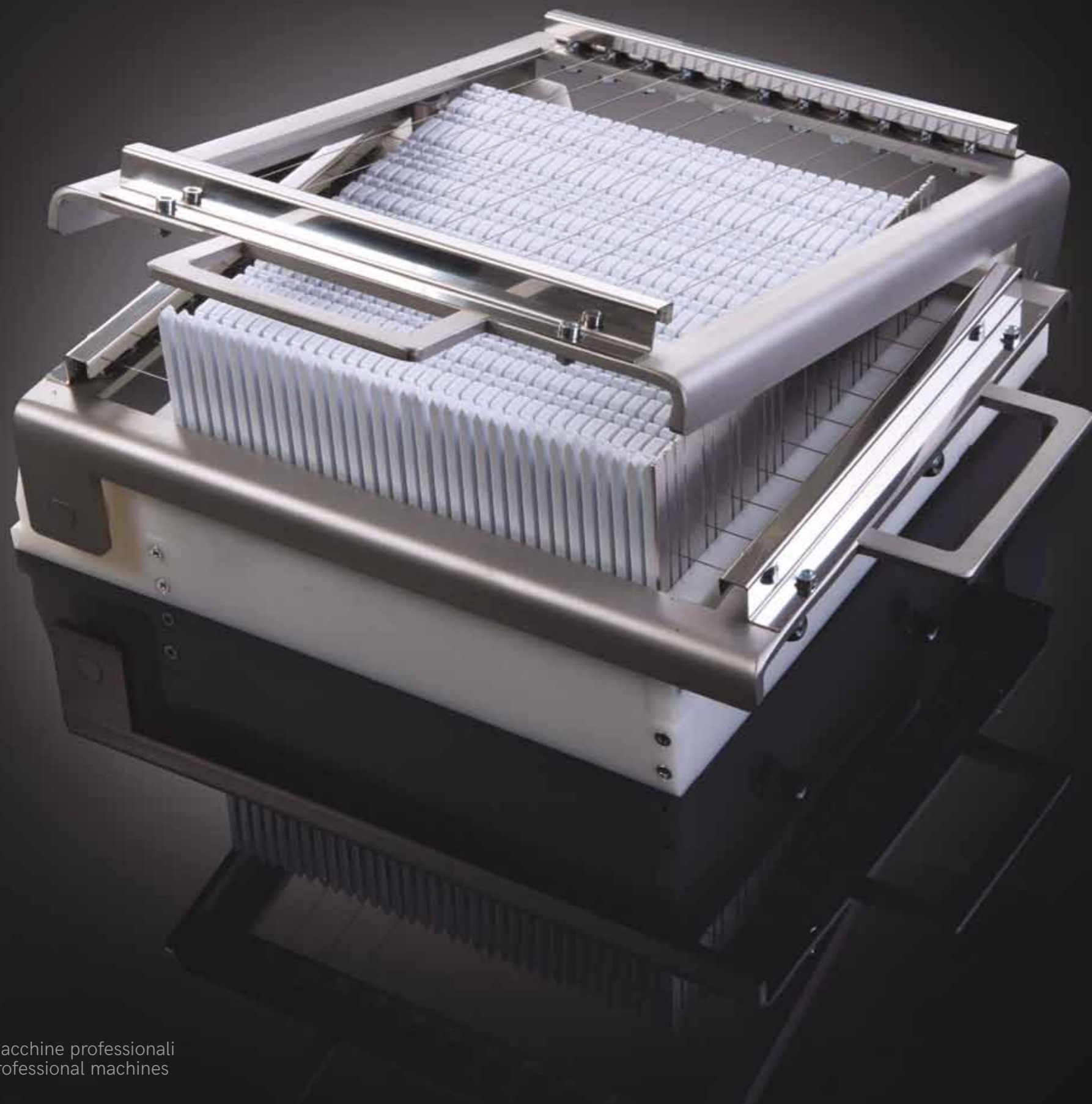

# MACCHINE PROFESSIONALI PROFESSIONAL MACHINES

SCIOGLITORI/MELTERS	128
CHITARRE/GUITARS	134
FONTANE/FONAINS	142



Realizzato in materiale plastico termoresistente, con vasca e coperchio removibili in acciaio inox e sonda termica per la regolazione della temperatura del cioccolato. La scheda elettronica gestisce la resistenza interna, per ottimizzare il raggiungimento del risultato richiesto, e rilevare la temperatura del cioccolato tramite la sonda esterna, per consentire un più rapido e preciso scioglimento del cioccolato. Il pannello frontale fornisce suggerimenti per il temperaggio, regolabile manualmente o seguendo i 3 programmi differenti in base al tipo di cioccolato: bianco, al latte e fondente. Le indicazioni del display aiutano l'operatore a completare le fasi del temperaggio e del mantenimento del cioccolato.

## DigitalMeltinChoc

MADE IN ITALY

Made of heat-resistant plastic material, with removable stainless steel bowl and lid, and thermal probe for chocolate temperature control. The electronic board manages the internal resistance to optimize the achievement of the required result, and detect the temperature of the chocolate through the external probe to allow a faster and more precise melting of the chocolate.

The front panel provides tempering tips, adjustable manually or following the 3 different programs depending on the type of chocolate: white, milk and dark. The display indications help the operator to complete the tempering and maintaining of the chocolate.

- **Temperatura costante ed omogenea**  
**Constant and homogenous temperature**
- **Vasca estraibile in acciaio inox**  
**Removable stainless steel basin**
- **Programmi selezionabili**  
**Preset programs**
- **Rapido scioglimento**  
**Quick melting**
- **Controllo digitale**  
**Digital control**
- **Display grafico**  
**Graphic display**
- **Sonda termica**  
**Thermal probe**
- **Indicatori sonori**  
**Sound indicators**



x 9L  
**MCDA103**  
x 13,7L  
**MCDA104**

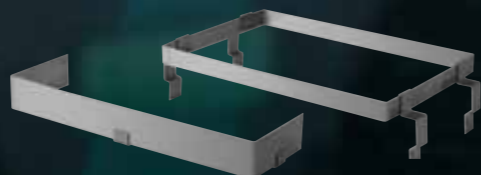

**KIT SUPPORTO STAMPO E PULISCI SPATOLA IN ACCIAIO INOX**  
**STAINLESS STEEL MOULD SUPPORT AND SPATULA CLEANER**

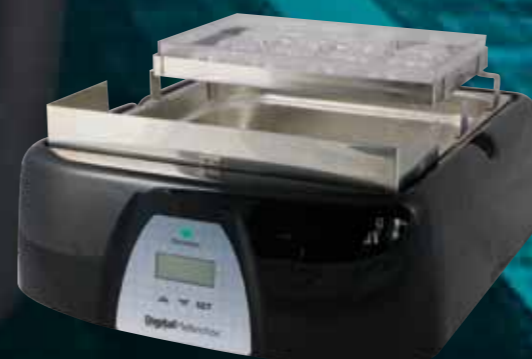

3,6 L

**MCD101**  
24x40 h13,5cm  
Vasca - Basin: 18x32,5 h10cm



6 L

**MCD102**  
33x40 h13,5cm  
Vasca - Basin: 26,5x32 h10cm



9 L

**MCD103**  
39,5x45 h13,5cm  
Vasca - Basin: 32x35,3 h10cm



13,7 L

**MCD104**  
39,5x62 h13,5cm  
Vasca - Basin: 32,5x53 h10cm



# Meltingchoc

MADE IN ITALY

## MELTINGCHOC ANALOGICI

I Meltingchoc sono degli strumenti indispensabili per la lavorazione del cioccolato.

Precisione, design, semplicità e ingombro ridotto sono i principali vantaggi di questi dispositivi in grado di soddisfare anche i pasticceri più esigenti. Gli scioglitori a secco analogici sono dotati di una pratica **vasca in acciaio inox** removibile con scocca e coperchio in plastica. Il termostato manuale permette di regolare e mantenere il cioccolato alla temperatura desiderata.

Realizzati in materiale plastico termoresistente, gli scioglitori per cioccolato hanno capienze comprese tra 0,8 e 13 litri.

## ANALOGUE MELTINGCHOC

The Meltingchoc are essential tools for chocolate processing.

Precision, design, ease of use and compactness are the main advantages of these devices, designed to meet the requirements of even the most demanding confectioners. Dry heat analogue melters are equipped with a practical and removable **stainless steel tank** with plastic lid and chassis. The manual thermostat allows you to adjust and maintain chocolate at the desired temperature.

Made with heat-resistant plastic, the chocolate melters can hold from 0,8 to 13 liters.



Scocca in resistente materiale plastico  
Shell made of durable plastic material

Termostato a regolazione manuale  
Manual regulation thermostat

## MONO



1,5 L

**MC105**

24x26 h13,5cm  
Vasca - Basin: 14x15,5 h10cm



3,6 L

**MC101**

24x40 h13,5cm  
Vasca - Basin: 18x32,5 h10cm



6 L

**MC102**

33x40 h13,5cm  
Vasca - Basin: 26,5x32 h10cm



9 L

**MC103**

39,5x45 h13,5cm  
Vasca - Basin: 32x35,3 h10cm



13,7 L

**MC104**

39,5x62 h13,5cm  
Vasca - Basin: 32,5x53 h10cm

## MULTI



0,8x3 L

**MC107**

Misure - Size: 39,5x26,5 h13,5cm  
Vasca - Basin: 8,3x15 h10cm



1,5x2 L

**MC108**

42x26 h13,5cm  
Vasca - Basin: 14x15,5 h10cm



1,5x3 L

**MC100**

61x26 h13,5cm  
Vasca - Basin: 14x15,5 h10cm



1,5x4 L

**MC106**

79x26 h13,5cm  
Vasca - Basin: 14x15,5 h10cm

Su richiesta disponibili scioglitori con cablaggio GB / USA / GIAPPONE / AUSTRALIA / CINA.  
UK / US / JAPAN / AUSTRALIA / CHINA wirings available upon request.



# MiniMeltinChoc

MADE IN ITALY

Lo scioglitore a secco per cioccolato MINI-MELTINCHOC può essere utilizzato sia in laboratorio per piccole produzioni di praline e soggetti di cioccolato che in gelateria per la copertura di gelati e dessert su stecco. Il design raffinato incentiva l'esposizione dello scioglitore in negozio favorendone l'utilizzo anche di fronte al pubblico. Realizzato in robusto materiale plastico antiurto. **Vaschetta estraibile in alluminio anodizzato.**

MINI-MELTINCHOC dry heat chocolate melters can be used for small productions of pralines and chocolate shapes, as well as in the ice-cream shops for the decorations of ice creams. Because of its modern design, the melter can be used also in the shop in front of the customers. Made of durable impact resistant plastic. **Removable basin made of anodized aluminium.**

Rosso - Red  
MC09R

Verde - Green  
MC09V

Lilla - Lilac  
MC09L

Grigio - Gray  
MC09G

1,8 L

Misure - Size:  
26x26 h16 cm



Termostato a regolazione manuale  
Manual regulation thermostat

Scocca in resistente materiale plastico  
Shell made of durable plastic material



**Vaschetta - Basin**  
MC000305

Vasca estraibile in alluminio anodizzato  
Removable basin in anodized aluminium  
Ø18,5 h10,7 cm

# DeepMeltinChoc

MADE IN ITALY

Scioglitore a secco pensato per le gelaterie, grazie alla sua forma e dimensione è ideale per coperture di cioccolato di gelati e semifreddi su stecco. Presentato con colorazione classica, che ricorda i toni del cioccolato, per adattarsi ad ogni tipologia di arredo e per essere utilizzato direttamente sul banco. Le caratteristiche tecniche degli scioglitori analogici, il termostato che consente di regolare 3 livelli di temperatura e la vasca estraibile in alluminio anodizzato, per una più facile pulizia fanno DEEP-MELTINCHOC un articolo essenziale.

Dry melter designed for ice cream parlours, thanks to its shape and size it is ideal for chocolate coatings of ice creams and semifreddi on sticks. Presented with the classical colour that reminds you of chocolate, to adapt to any type of environment and to be used straight on the counter. The technical characteristics of analogue melters, the thermostat that allows to adjust 3 levels of temperature and the extractable tray in anodized aluminium (to make cleaning easier), make DEEP-MELTINCHOC an essential item.

NEW

1,7 L

**Deep MeltinChoc**  
MC10  
Ø20,5 h21,2 cm



Tre livelli di regolazione  
Three levels of regulation

Scocca, coperchio e fondo in resistente materiale plastico  
Body, lid and bottom in durable plastic material



**Vaschetta - Basin**  
MC001001

Vasca estraibile in alluminio anodizzato  
Removable basin in anodized aluminium  
Ø14 h18 cm



# CHITARRE CLASSICHE CLASSIC GUITAR



CHITDOUBLE

CHITCOMP

Chitarra a taglio doppio con 4 TELAI INCLUSI.  
Double guitar composed of 4 FRAMES INCLUDED.

PIANO DI TAGLIO  
CUTTING PLACE

38X42CM

L'articolo non include:  
The article doesn't include:

Telaio -Frame

Misura Size	Codice - Code
15 mm	CHITRIC 1/D

Telaio laterale - Lateral frame

Misura Size	Codice - Code
20 mm	CHITRIC 2/LD

Chitarra a taglio semplice con 3 TELAI INCLUSI.  
Single guitar composed of 3 FRAMES INCLUDED.

PIANO DI TAGLIO  
CUTTING PLACE

36X41CM

L'articolo non include:  
The article doesn't include:

Telaio -Frame

Misura Size	Codice - Code
15 mm	CHITRIC 1

## DOUBLE

### CHITDOUBLE

L'articolo include

- 1 Base ABS 58,5x48 h15,5cm.
- 1 telaio inox per tagli da 22,5 mm.
- 1 telaio inox per tagli da 30 mm.
- 1 telaio inox per tagli da 45 mm.
- 1 telaio inox per tagli da 30 mm. (Telaio fisso laterale)
- 1 piatto inox.
- 1 racla PST.
- 3 fili di ricambio.
- 2 chiavi per il fissaggio fili.

The article includes

- 1 plastic base 58,5x48 h15,5cm.
- 1 st. steel cutting frame 22,5 mm.
- 1 st. steel cutting frame 30 mm.
- 1 st. steel cutting frame 45 mm.
- 1 st. steel cutting frame 30 mm. (Fixed side steel cutting frame)
- 1 st. steel sheet.
- 1 plastic spatula.
- 3 free st. steel strings.
- 2 spanners to change strings.

Telai - Fames

Descrizione	Description	Codice - Code
Telaio Laterale 30 mm	Lateral Frame 30 mm	CHITRIC 1/LD
Telaio 22,5 mm	Frame 22,5 mm	CHITRIC 2/D
Telaio 30 mm	Frame 30 mm	CHITRIC 3/D
Telaio 45 mm	Frame 45 mm	CHITRIC 4/D

Parti ricambio - Spare parts

Descrizione	Description	Codice - Code
Base ABS	Plastic Base	CHITRIC 5/D
Piatto Inox	Steel Sheet	CHITRIC 6/D
Racla Pst	Plastic Spatula	SPB
2 Chiavi Fissaggio	2 Special Spanner	CHITRIC 8
1 Filo Inox	1 Steel Strings	CHITRIC 9
2 viti 2 dadi	2 bolts 2 nuts	CHITRIC 10

## SINGLE

### CHITCOMP

L'articolo include

- 1 Base ABS 50x44 h15,5 cm.
- 1 telaio inox per tagli da 22,5 mm.
- 1 telaio inox per tagli da 30 mm.
- 1 telaio inox per tagli da 45 mm.
- 1 piatto inox.
- 1 racla PST.
- 3 fili di ricambio.
- 2 chiavi per il fissaggio fili.

The article includes

- 1 plastic base 50x44 h15,5 cm.
- 1 st. steel cutting frame 22,5 mm.
- 1 st. steel cutting frame 30 mm.
- 1 st. steel cutting frame 45 mm.
- 1 st. steel sheet to put cakes .
- 1 plastic spatula.
- 3 free st. steel strings.
- 2 spanners to change strings.

Telai - Fames

Descrizione	Description	Codice - Code
Telaio 22,5 mm	Frame 22,5 mm	CHITRIC 2
Telaio 30 mm	Frame 30 mm	CHITRIC 3
Telaio 45 mm	Frame 45 mm	CHITRIC 4

Parti ricambio - Spare parts

Descrizione	Description	Codice - Code
Base ABS	Plastic Base	CHITRIC 5
Piatto Inox	Steel Sheet	CHITRIC 6/D
Racla Pst	Plastic Spatula	SPB
2 Chiavi Fissaggio	2 Special Spanner	CHITRIC 8
1 Filo Inox	1 Steel Strings	CHITRIC 9
2 viti 2 dadi	2 bolts 2 nuts	CHITRIC 10



# CHITARRE GUITAR EASY SYSTEM

Il nuovo sistema ad incastro facilita notevolmente l'inserimento ed il cambio dei telai, riducendo sensibilmente i tempi di montaggio, smontaggio e manutenzione.

La chitarra è composta da una nuova e più solida base in plastica e da una serie di telai di diverse misure fornibili separatamente in base alle esigenze del singolo operatore, è predisposta per il taglio di grandi quantità di cioccolatini calibrati e tagliati in modo preciso e privo di imperfezioni.

The new simple system of interlocking frames incredibly reduces assembly and disassembly time, it is sufficient to place them in the seats and you're done. The guitar is capable of cutting large amounts of cremini perfectly matched with a clean and precise cut.



## DOUBLE

Chitarra a taglio doppio TELAI NON INCLUSI. Struttura esterna in alluminio.  
Double guitar FRAMES NOT INCLUDED. Aluminium external structure.

PIANO DI TAGLIO  
CUTTING PLACE

35X35CM



50-CD100N

Telaio base in alluminio  
Base frame in aluminum



## SINGLE

Chitarra a taglio semplice TELAI NON INCLUSI.  
Single guitar FRAMES NOT INCLUDED.

PIANO DI TAGLIO  
CUTTING PLACE

36X42CM



50-CS100

Base in polietilene  
Base in polyethylene



Inclusi nella confezione delle basi: 1 piatto inox - 1 racla PST - 3 fili di ricambio - 2 chiavi per il fissaggio fili.  
The article includes: 1 plastic spatula - 3 free st. steel strings - 2 spanners to change strings.

Telai non inclusi nel kit - Frames not included in the kit

Tutti i telai sono adatti per il taglio frontale e laterale - tranne il telaio da 15 mm, predisposto solo al taglio frontale.  
All frames are interchangeable, except the 15mm which cannot be used **only** for side cutting.

Misura Size	Codice - Code
15 mm	50-C015
22,5 mm	50-C022
30 mm	50-C030
45 mm	50-C045

Parti ricambio - Spare parts

Descrizione	Description	Codice - Code
1 piatto inox	1 Steel sheet	CHITRIC 6/D
1 Spatola	1 Spatula	SPB
2 Chiavi Fissaggio	2 Special Spanner	CHITRIC 8
1 Filo Inox	1 Steel Strings	CHITRIC 9
2 viti 2 dadi	2 bolts 2 nuts	CHITRIC 10



# CHITARRE MINI GUITAR EASY SYSTEM

La MiniChitarra, ideale per ristoranti gelaterie e cioccolaterie, è adatta a piccole produzioni di prodotti dolciari.

Grazie alle dimensioni contenute può essere facilmente stoccata anche in piccoli spazi e utilizzata all'occorrenza.

Il nuovo sistema ad incastro favorisce un veloce e pratico cambio dei telai.

The MiniChitarra, ideal for restaurants, ice-cream parlors and chocolates, is suitable for small productions of confectionery products. Given the dimensions, it can easily be stored in small spaces and used only when necessary. The new interlocking system makes the change of the frames quick and practical.



Maniglia allungata per una comoda impugnatura  
Elongated handle for a comfortable grip

Filo sostituibile singolarmente  
Individually replaceable wire

Elementi in resistente materiale plastico  
elements in resistant plastic material

Base in polietilene leggera e maneggevole  
Base in light and handy polyethylene

Incisione misura di taglio su ogni telaio  
Cutting cut incision on each frame

Cutting cut incision on each frame

Telai universali in acciaio inox  
Universal frames in stainless steel

Nuovo sistema ad incastro  
New system of interlocking frames



## DOUBLE

Chitarre doppie, con due telai inclusi.  
Double guitars composed of 2 frames.

PIANO DI TAGLIO  
CUTTING PLACE

24X25CM

Misure telai Frame Size	Codice Code
22 mm	CHITMINID22
30 mm	CHITMINID30



## SINGLE

Chitarre a taglio semplice, con un telaio incluso.  
Single guitars composed of 1 frame.

PIANO DI TAGLIO  
CUTTING PLACE

25X28CM

Misure telai Frame Size	Codice Code
22 mm	CHITMINI
15 mm	CHITMINI15
30 mm	CHITMINI30



Inclusi nelle confezioni: 1 piatto inox - 1 racla PST - 3 fili di ricambio - 2 chiavi per il fissaggio fili.  
The articles includes: 1 plastic spatula - 3 free st. steel strings - 2 spanners to change strings.

Telai non inclusi nel kit - Frames not included in the kit

Tutti i telai sono adatti per il taglio frontale e laterale - tranne il telaio da 15 mm, predisposto **solo** al taglio frontale.  
All frames are interchangeable, except the 15mm which cannot be used **only** for side cutting.

Misura Size	Codice - Code
15 mm	CHIT15
22 mm	CHIT22
30 mm	CHIT30

Parti ricambio - Spare parts

Descrizione	Description	Codice - Code
1 piatto inox	1 Steel sheet	CHITP
1 Spatola	1 Spatula	SPBMINI
2 Chiavi Fissaggio	2 Special Spanner	CHITRIC 8
1 Filo Inox	1 Steel Strings	CHITRIC 9
2 viti 2 dadi	2 bolts 2 nuts	CHITRIC 10
Base Singola	Single base	CHITBA24
Base Doppia	Double base	CHITBAD24



# CHITARRE GUITAR EASY SYSTEM

Il filo corto garantisce una maggiore resistenza meccanica e consente quindi di tagliare in porzioni precise anche gli impasti molto duri o congelati.

Facile da pulire, questo strumento non richiede alcuna manutenzione.

The shortness of wires ensures more mechanical resistance and the possibility to cut hard and frozen products.

Easy and practical cleaning.  
No maintenance needed.

Struttura e telai in alluminio  
Structure and frames in aluminum



Manopola di avanzamento grande per permettere un taglio più preciso e delicato

Large hand wheel to allow a more delicate cut

Base di avanzamento asportabile per una migliore pulizia

Removable base for better cleaning

Inserimento dei telai ad incastro  
Inserting the interlocking frames



## GRANDE - BIG

TELAI NON INCLUSI - FRAMES NOT INCLUDED

PIANO DI TAGLIO - CUTTING PLACE

60X60CM

**CSM060**

Misura chitarra chiusa - Closed guitar size:

**73x103 h30 cm**

Misura apertura massima - Size open:

**73x167 cm**

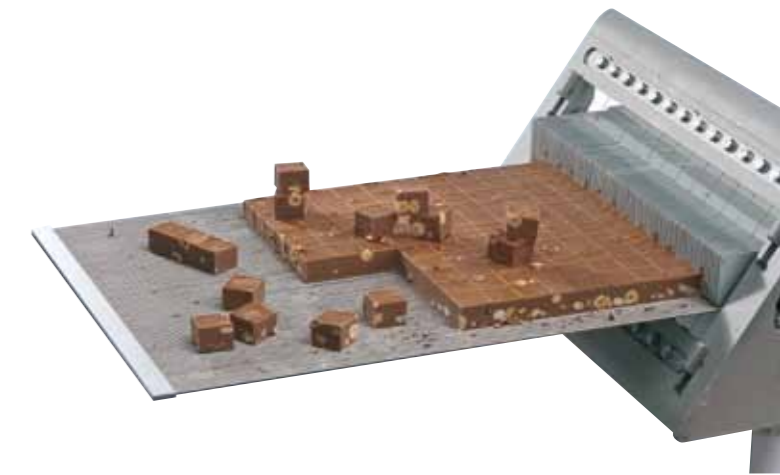

## PICCOLA - SMALL

TELAI NON INCLUSI - FRAMES NOT INCLUDED

PIANO DI TAGLIO - CUTTING PLACE

40X40CM

**CSM040**

Misura chitarra chiusa - Closed guitar size:

**53x83 h30 cm**

Misura apertura massima - Size open:

**53x126 cm**

### Telai non inclusi nel kit - Frames not included in the kit

Misura Size	Codice - Code	Misura Size	Codice - Code
10 mm	<b>CSM06001</b>	35 mm	<b>CSM06006</b>
15 mm	<b>CSM06002</b>	40 mm	<b>CSM06007</b>
20 mm	<b>CSM06003</b>	50 mm	<b>CSM06008</b>
25 mm	<b>CSM06004</b>	60 mm	<b>CSM06009</b>
30 mm	<b>CSM06005</b>		

### Parti ricambio - Spare parts

Descrizione	Description	Codice - Code
chiavi di fissaggio	spanners	<b>CHITRIC 8</b>
filo inox	inox wire	<b>CHITRIC 9</b>
spatola plastica	plastic spatula	<b>CSMSPB60</b>
piatto inox	inox sheet	<b>CSM0602</b>

### Telai non inclusi nel kit - Frames not included in the kit

Misura Size	Codice - Code	Misura Size	Codice - Code
10 mm	<b>CSM04001</b>	35 mm	<b>CSM04006</b>
15 mm	<b>CSM04002</b>	40 mm	<b>CSM04007</b>
20 mm	<b>CSM04003</b>	50 mm	<b>CSM04008</b>
25 mm	<b>CSM04004</b>	60 mm	<b>CSM04009</b>
30 mm	<b>CSM04005</b>		

### Parti ricambio - Spare parts

Descrizione	Description	Codice - Code
chiavi di fissaggio	spanners	<b>CHITRIC 8</b>
filo inox	inox wire	<b>CHITRIC 9</b>
spatola plastica	plastic spatula	<b>CSMSPB40</b>
piatto inox	inox sheet	<b>CSM0402</b>

Inclusi nella confezione delle basi: 1 piatto inox - 1 racla PST - 2 chiavi per il fissaggio fili.  
The article includes: 1 plastic spatula - 2 spanners to change strings.



# FONTANE CIOCCOLATO CHOCOLATE FOUNTAIN



Realizzate in acciaio inox,  
resistenti ad alte temperature.  
Mantengono la cioccolata  
alla temperatura di 36/39°C.  
Facili da usare e da pulire.

Made of stainless steel.  
To keep chocolate at 36/39°C.  
Easy to use and clean.



### CHOCOFONT

Ø 210mm h390mm  
Capacità: circa 1 litro  
220 - 240V - 50 Hz  
Amps 0,77A - 170W

Coclea in resistente materiale plastico

Auger in resistant plastic material



### CHOCOBIG

Ø380 h800 mm  
Capacità: circa 3,5 litri  
230V - 50 Hz  
Amps 1.6A - 370W

Coclea in acciaio inox, funzionamento silenzioso.

Auger in stainless steel, silent operation.



### 20-4000

Ø 440 h1000 mm  
Capacità: circa 5 litri  
230V - 50/60 Hz  
Amps : 2,5A - 450W

Coclea in acciaio inox, funzionamento silenzioso.  
Salti staccabili dalla torre per una migliore pulizia  
Piedini regolabili

Auger in stainless steel, silent operation.  
Removable levels for better cleaning  
Adjustable feet

## FOUNTAINS ACCESSORIES



Forma rotonda.  
Round shaped.

per/for CHOCOFONT

### CHOCORING

Rosso - Red

### CHOCORING06

Satinato - Glazed

Ø 520mm x h 160mm

Copri fontana in plexiglass con comodi ripiani.  
Plexiglass ring cover for chocolate fountain with useful displays.

Forma rotonda.  
Round shaped.

per/for CHOCOBIG

### CHOCOBIGRING

Rosso - Red

### CHOCOBIGRING06

Satinato - Glazed

Ø650 mm x h 170mm

Forma ovalizzata.  
Oval shaped.

per/for 20-4000

### 20-R4000

Satinato - Glazed

810x810 h 165 mm





## SEMIFREDDO & COTTURA

## SEMIFREDDO & BAKING

COMBI 3D	146
ONE STRIP	148
DESSERT IDEA	150
CAKE IDEA	154
SMART	160
STAMPI SEMIFREDDO	
SEMIFREDDO MOULDS	164
FASCE INOX	
STAINLESS STEEL BANDS	176
STAMPI COTTURA	
BAKING MOULDS	182



# COMBI

THREE-DIMENSIONAL SEMIFREDDO

Un'intuizione Martellato e la creatività del maestro Omar Busi si incontrano in **COMBI3D**: il sistema che unisce le qualità delle fasce inox e i vantaggi degli stampi termoformati, per ottenere favolosi semifreddi tridimensionali. Con **COMBI3D** potrai combinare in modo semplice e veloce diversi gusti e colori per risultati perfetti.

An intuition from Martellato and the creativity of master Omar Busi meet in **COMBI3D**: the system that combines the quality of stainless steel cake rings and the advantages of thermoformed moulds to obtain wonderful three-dimensional semifreddi. With **COMBI3D** you can combine various flavours and colours simply and quickly for perfect results.



Creatività OMAR BUSI

*Omar Busi*



## GALAXY NEW

Kit composto da:  
fascia inox 2 pcs  
stampi termoformati 2+2 pcs

**30COMBI01**  
Ø18 cm

**30COMBI02**  
Ø22 cm



## SUPERNOVA NEW

Kit composto da:  
fascia inox 2 pcs  
stampi termoformati 2 pcs

**30COMBI03**  
Ø18 cm





One  
Strip

**Con gli stampi monouso per semifreddo il lavoro sarà più facile ed organizzato.**

Si ridurranno i tempi di preparazione, sarà possibile conservare il dolce direttamente nello stampo fino al momento dell'utilizzo grazie alla pellicola protettiva e poi si sformerà semplicemente con uno strappo.

La rivoluzione degli stampi: i tempi di raffreddamento, anche in abbattitore, saranno più brevi, non dovranno più essere lavati, asciugati e stoccati risparmiando energia tempo e spazio, ma soprattutto, garantiranno la massima igiene.

**Work will be easier and more organized with the disposable semifreddo moulds.**

Preparation time will be cut and, thanks to the protective film, the sweet will be kept in its mould until it needs to be used and will then be released from it with just one tear.

The mould revolution: cooling times, even in the blast chiller, will be shorter, moulds will no longer be washed, dried and stored, saving energy, space and time but, above all, they will guarantee maximum hygiene.

One  
Strip

## DISPOSABLE SEMIFREDDO MOULDS



NEW

**30ONE18**  
Ø180 h50 mm  
100 pcs



NEW

**30ONE20**  
Ø200 h50 mm  
100 pcs

MADE IN ITALY

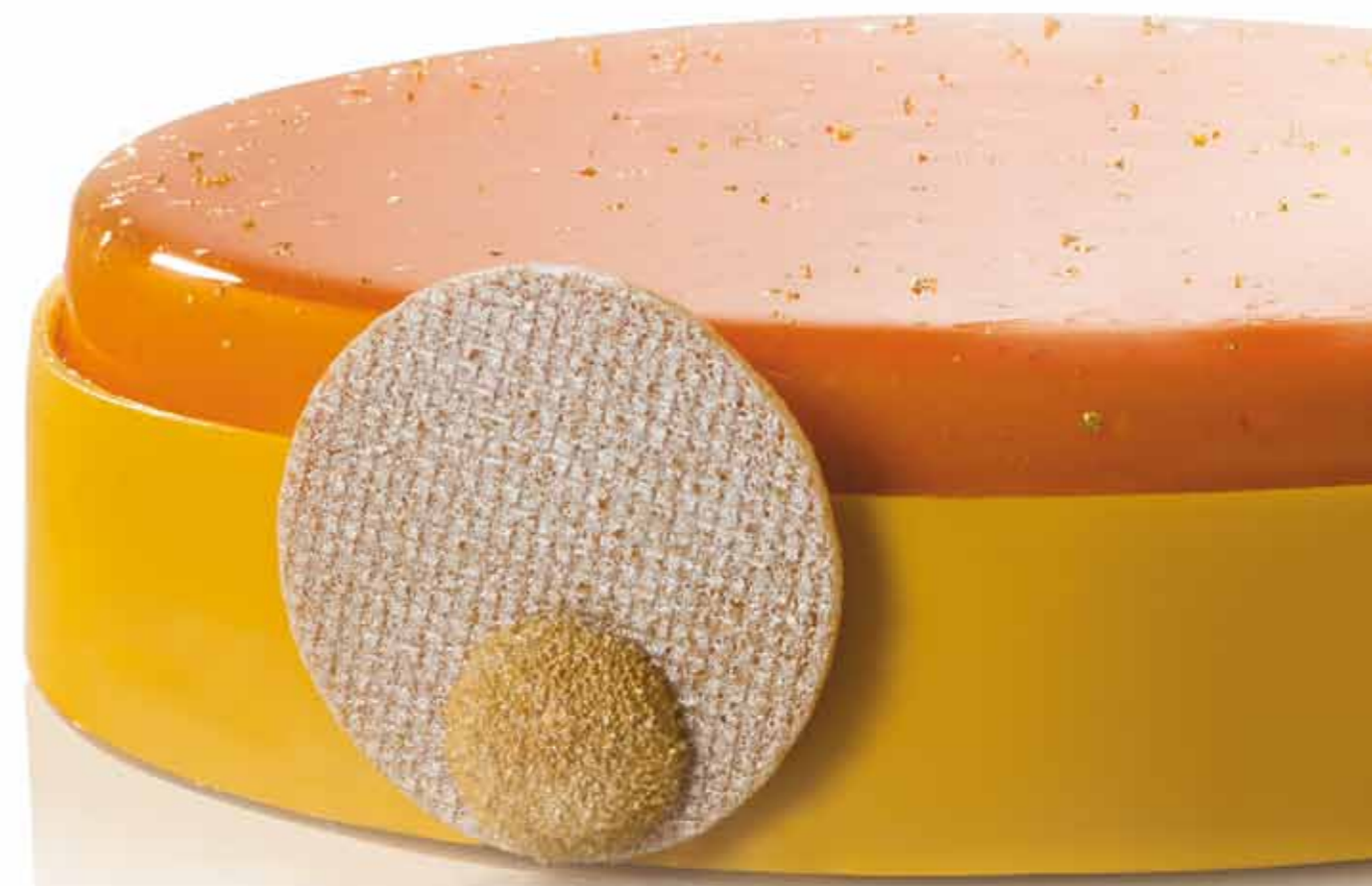





# Dessert idea

## *La tradizione crea la modernità*

Combinare gli elementi per dare vita a monoporzioni che, giocando con le proporzioni dei sapori, creano nuove armonie di gusto. Nasce con questo intento un progetto di dessert al piatto componibili, pensato per la ristorazione ma perfetto per la pasticceria moderna, che utilizzando semplici attrezzature consente risultati di alto livello. Monoporzioni che accostano diversi gusti, diverse consistenze, diversi colori per stimolare e soddisfare la voglia di assaggiare dei clienti, combinando misure e forme diverse.

## *Tradition creates modernity*

Combine these elements for single portions that, by playing with the flavour proportions, create new taste harmonies. From this aim, a design for a modular dessert was born, designed for the restaurant industry but perfect for modern pastry-making, that allows for high level results using simple tools.

Single portions to suit various tastes, consistencies, and colours that inspire and satisfy customers' desire to try something new, by combining different shapes and sizes.







Circle

**30IDEA01**

Ø83 h 25mm ~ 130ml  
Prod. 12 pcs



Tagliapasta - Cutter  
**TPIDEA01**



Rectangle

**30IDEA02**

62x48 h 25mm ~ 70ml  
Prod. 18 pcs



Tagliapasta - Cutter  
**TPIDEA02**



Log

**30IDEA03**

118x47 h 25mm ~ 130ml  
Prod. 9 pcs



Tagliapasta - Cutter  
**TPIDEA03**



Triangle

**30IDEA04**

42x38 h 25mm ~ 25ml  
Prod. 48 pcs

Conf./Pack:  
3 barre/bars  
1 estrattore/extractor



Dot

**30IDEA05**

Ø35 h 25mm ~ 25ml  
Prod. 48 pcs



Square

**30IDEA06**

30x30 h 25mm ~ 25ml  
Prod. 48 pcs





## LE COMPONENTI INOX

TANTE FORME, MOLTE COMBINAZIONI,  
CREATIVITÀ ILLIMITATA.

Le fasce inox componibili consentono  
la preparazione di un unico dolce che  
accontenta diverse richieste.

Con i Kit per inserti e basi l'effetto  
sarà ancora più spettacolare.

MANY SHAPES, MANY COMBINATIONS,  
UNLIMITED CREATIVITY.

The stainless steel modular ring  
allow you to create unique desserts  
depending on what you need.

Use the inserts and bases kits for an  
even more special effect.



DEMI

**39H4X20S**

Size: Ø180 h40 mm  
985ml - Pack 2 pcs

**39H4X24S**

Size: Ø220 h40 mm  
1473ml - Pack 2 pcs



**39KITH4X20**

KIT COMPONENTI 20cm  
985ml - Pack 6 pcs

**39KITH4X24**

KIT COMPONENTI 24cm  
1473ml - Pack 6 pcs



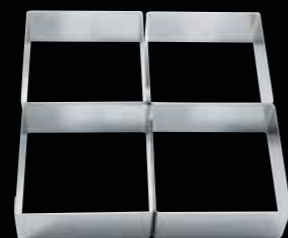

4 TASTE

**38H4X22S**

Misura - Size: 200x200 h40 mm  
1500ml - Pack 4 pcs

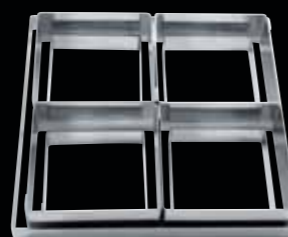

**38KITH4X22**

KIT COMPONENTI 22cm  
1500ml - Pack 9 pcs

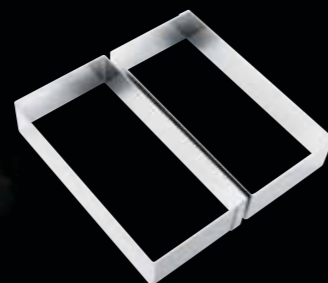

DOUBLE

**37H4X22S**

Misura - Size: 200x200 h40 mm  
1500ml - Pack 2 pcs



**37KITH4X22**

KIT COMPONENTI 22cm  
1500ml - Pack 5 pcs



MOON

**36H4X22S**

Misura - Size: Ø200 h40 mm  
1000ml - Pack 2 pcs



**36KITH4X22**

KIT COMPONENTI Ø 22cm  
1000ml - Pack 5 pcs





DUETTO

**33H4X20S**  
Misura - Size: Ø200 h40 mm  
950ml - Pack 2 pcs

**33H4X24S**  
Misura - Size: Ø240 h40 mm  
1400ml - Pack 2 pcs



**33KITH4X20**  
KIT COMPONENTI Ø 22cm  
950ml - Pack 6 pcs

**33KITH4X24**  
KIT COMPONENTI Ø 26cm  
1400ml - Pack 6 pcs



TWINS

**34H4X16S**  
Misura - Size: 160x160 h40 mm  
950ml - Pack 2 pcs

**34H4X20S**  
Misura - Size: 200x200 h40 mm  
1400ml - Pack 2 pcs



**34KITH4X16**  
KIT COMPONENTI 18cm  
950ml - Pack 6 pcs

**34KITH4X20**  
KIT COMPONENTI 23cm  
1400ml - Pack 6 pcs



HEART

**35H4X14S**  
Misura - Size: Ø140 h40 mm  
530ml - Pack 2 pcs

**New size**  
**35H4X19S**  
Misura - Size: Ø190 h40 mm  
1000ml - Pack 2 pcs



**New size**  
**35KITH4X19**  
KIT COMPONENTI Ø 19cm  
1000ml - Pack 4 pcs



TRILOGY

**32H4X18S**  
Misura - Size: Ø180 h40 mm  
950ml - Pack 3 pcs

**32H4X22S**  
Misura - Size: Ø220 h40 mm  
1400ml - Pack 3 pcs





# SMART

YOUR EASY DESSERT

**PRATICI, VELOCI E FACILI:**  
 Gli stampi termoformati consentono di realizzare in pochi semplici passaggi, semifreddi che si raffreddano perfettamente in tempi brevi e si sformano facilmente.

**PRACTICAL, QUICK AND EASY:**  
 In a few simple steps, the thermoformed moulds allow you to create semifreddo desserts that cool perfectly in a short time and that are easy to turn out.



CIRCLE



**30SS01**  
 Ø180 H50 MM  
 1200 ML - PACK 4 PCS



**BASE**  
**1H2X20**  
 Ø200 H20 MM

**INSERTO - INSERT**  
**1H2X16**  
 Ø160 H20 MM

CARRÉ



**30SS02**  
 180X180 H50 MM  
 1500 ML - PACK 4 PCS



**BASE**  
**5H2X20**  
 200X200 H20 MM

**INSERTO - INSERT**  
**5H2X16**  
 160X160 H20 MM





OVAL



**30SS03**  
240x136 h60 mm  
1400 ml - Pack 4 pcs

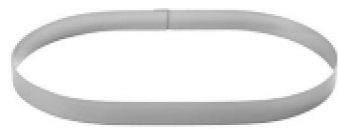

**Base**  
**21H2X26**  
258x154 h20 mm

**Inserto - Insert**  
**21H2X21**  
216x112 h20 mm

HEART



**30SS06**  
171x162 h48 mm  
815 ml - Pack 4 pcs



**Base**  
**70H2X19**  
191x182 h20 mm

**Inserto - Insert**  
**70H2X13**  
132x125 h20 mm

GIANDUIA



**30SS04**  
284x116 h80 mm  
1400 ml - Pack 4 pcs



**Base**  
**21H2X31**  
303x135 h20 mm

**Inserto - Insert**  
**21H2X23**  
230x63,5 h20 mm

SMALL  
GIANDUIA



**30SS05**  
245x79 h75 mm  
850 ml - Pack 4 pcs



**Base**  
**21H2X26G**  
265x98 h20 mm

**Inserto - Insert**  
**21H2X20G**  
200x36 h20 mm



# STAMPI SEMIFREDDO

## SEMIFREDDO MOULDS

Lo stampo Martellato è realizzato in materiale plastico resistente ma allo stesso tempo sufficientemente flessibile per permettere una facile estrazione.

Conf. 2 pezzi, formato piccolo e grande.

Martellato moulds are made of durable plastic, but at the same time sufficiently flexible to allow easy extraction.

Pack 2 pcs,  
big and small size of the same shape.



**SS001**  
243x123 h35mm  
196x117 h40mm



**SS002**  
237x126 h60mm  
180x110 h50mm



**SS003**  
243x116 h50mm  
204x105 h45mm



**SS004**  
255x110 h46mm  
205x104 h45mm



**SS007**  
197x197 h55mm  
157x157 h45mm



**SS010**  
200x200 h70mm  
160x160 h60mm



**SS011**  
204x204 h35mm  
163x163 h40mm



**SS022**  
185x185 h50mm  
150x150 h45mm



**SS015**  
Ø210 h40mm  
Ø160 h45mm

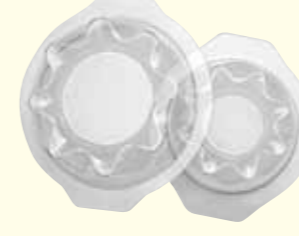

**SS018**  
Ø205 h55mm  
Ø160 h50mm



**SS019**  
Ø195 h60mm  
Ø160 h55mm



**SS013**  
Ø205 h45mm  
Ø165 h40mm



**SS024**  
250x136 h72mm  
180x98 h52mm



**SS025**  
245x130 h63mm  
178x96 h42mm



**SS027**  
248x153 h68mm  
180x111 h50mm



**SS030**  
236x126 h70mm  
172x92 h50mm



**SS033**  
250x115 h70mm  
185x86 h52mm



**SS034**  
250x116 h70mm  
180x84 h50mm



**SS035**  
235x98 h70mm  
180x87 h50mm



**SS036**  
245x100 h71mm  
180x73 h50mm





# MONOPORZIONI E MIGNON MONOPORTIONS & MIGNON

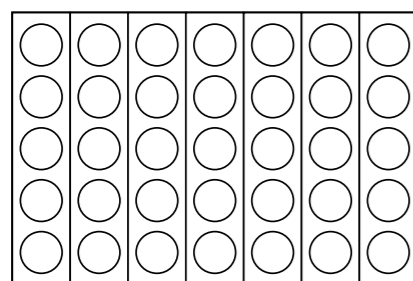

MONOP. C

60X40CM

7 Barre/Moulds  
35 monoportion

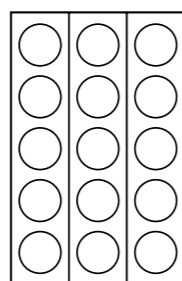

MONOP. B

26X40CM

3 Barre/Moulds  
15 monoportion

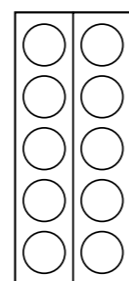

MONOP. A

17X40CM

2 Barre/Moulds  
10 monoportion

## CIRCLE



mm	h mm	prod 10 pcs	prod 15 pcs	prod 35 pcs	Extractor	Cutter
Ø 65	40	MONOP. A001	MONOP. B001	MONOP. C001	EM 1	TPG 1
Ø 65	30	MONOP. A01	MONOP. B01	MONOP. C01	EM 1	TPG 1
Ø 45	45	MONOP. A1	MONOP. B1	MONOP. C1	EM 01	TPG 01

## OVAL



mm	h mm	prod 10 pcs	prod 15 pcs	prod 35 pcs	Extractor	Cutter
Ø 65	40	MONOP. A002	MONOP. B002	MONOP. C002	EM 2	TPG 2
Ø 65	30	MONOP. A02	MONOP. B02	MONOP. C02	EM 2	TPG 2

## EXAGONAL

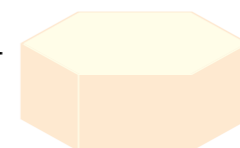

mm	h mm	prod 10 pcs	prod 15 pcs	prod 35 pcs	Extractor	Cutter
Ø 65	40	MONOP. A003	MONOP. B003	MONOP. C003	EM 3	TPG 3

## TRIANGLE



mm	h mm	prod 10 pcs	prod 15 pcs	prod 35 pcs	Extractor	Cutter
Ø 65	40	MONOP. A004	MONOP. B004	MONOP. C004	EM 4	TPG 4



SQUARE

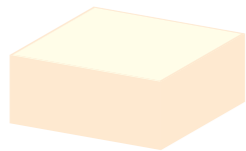

mm	h mm	prod 10 pcs	prod 15 pcs	prod 35 pcs	Extractor	Cutter
Ø 65	40	MONOP. A005	MONOP. B005	MONOP. C005	EM 5	TPG 5

RHOMBUS

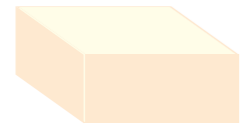

mm	h mm	prod 10 pcs	prod 15 pcs	prod 35 pcs	Extractor	Cutter
Ø 65	40	MONOP. A006	MONOP. B006	MONOP. C006	EM 6	TPG 6

HEART

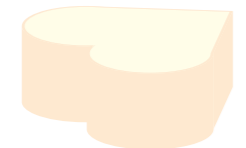

mm	h mm	prod 10 pcs	prod 15 pcs	prod 35 pcs	Extractor	Cutter
Ø 65	40	MONOP. A007	MONOP. B007	MONOP. C007	EM 7	TPG 7

DROP



mm	h mm	prod 10 pcs	prod 15 pcs	prod 35 pcs	Extractor	Cutter
Ø 65	40	MONOP. A008	MONOP. B008	MONOP. C008	EM 8	TPG 8

COMMA



mm	h mm	prod 10 pcs	prod 15 pcs	prod 35 pcs	Extractor	Cutter
Ø 65	40	MONOP. A009	MONOP. B009	MONOP. C009	EM 9	TPG 9

FLOWER

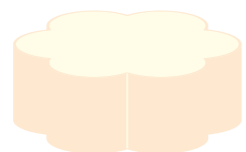

mm	h mm	prod 10 pcs	prod 15 pcs	prod 35 pcs	Extractor	Cutter
Ø 65	40	MONOP. A0012	MONOP. B0012	MONOP. C0012	EM 12	TPG 12

OBLONG

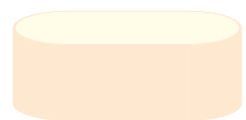

mm	h mm	prod 10 pcs	prod 15 pcs	prod 35 pcs	Extractor	Cutter
Ø 65	40	MONOP. A0013	MONOP. B0013	MONOP. C0013	EM 13	TPG 13



**Kit completo**  
Complete kit

L'articolo include vassoio e barre  
The article includes tray and bars



**Estrattori**  
Extractors

Non inclusi  
Not included



**Tagliapasta**  
Cutters

Non inclusi  
Not included

# MIGNON

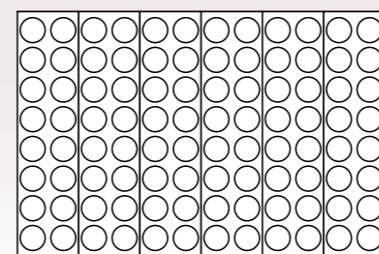

**MIGNON C**  
**60X40CM**  
6 Barre/Moulds  
96 mignon

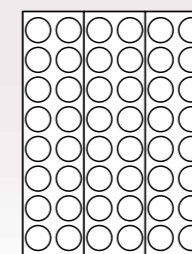

**MIGNON B**  
**30X40CM**  
3 Barre/Moulds  
48 mignon

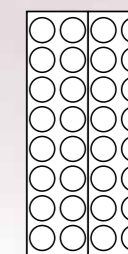

**MIGNON A**  
**20X40CM**  
2 Barre/Moulds  
32 mignon

CIRCLE



mm	h mm	prod 32 pcs	prod 48 pcs	prod 96 pcs	Extractor	Cutter
Ø 25	25	MIGNON A001	MIGNON B001	MIGNON C001	ED 1	TPM 1

OVAL



mm	h mm	prod 32 pcs	prod 48 pcs	prod 96 pcs	Extractor	Cutter
Ø 25	25	MIGNON A002	MIGNON B002	MIGNON C002	ED 2	TPM 2

EXAGONAL

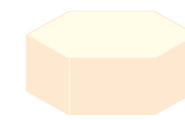

mm	h mm	prod 32 pcs	prod 48 pcs	prod 96 pcs	Extractor	Cutter
Ø 25	25	MIGNON A003	MIGNON B003	MIGNON C003	ED 3	TPM 3

TRIANGLE



mm	h mm	prod 32 pcs	prod 48 pcs	prod 96 pcs	Extractor	Cutter
Ø 25	25	MIGNON A004	MIGNON B004	MIGNON C004	ED 4	TPM 4

SQUARE

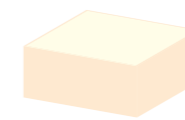

mm	h mm	prod 32 pcs	prod 48 pcs	prod 96 pcs	Extractor	Cutter
Ø 25	25	MIGNON A005	MIGNON B005	MIGNON C005	ED 5	TPM 5

RHOMBUS

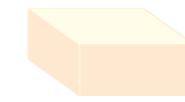

mm	h mm	prod 32 pcs	prod 48 pcs	prod 96 pcs	Extractor	Cutter
Ø 25	25	MIGNON A006	MIGNON B006	MIGNON C006	ED 6	TPM 6

HEART



mm	h mm	prod 32 pcs	prod 48 pcs	prod 96 pcs	Extractor	Cutter
Ø 25	25	MIGNON A007	MIGNON B007	MIGNON C007	ED 7	TPM 7

DROP



mm	h mm	prod 32 pcs	prod 48 pcs	prod 96 pcs	Extractor	Cutter
Ø 25	25	MIGNON A008	MIGNON B008	MIGNON C008	ED 8	TPM 8

COMMA

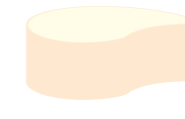

mm	h mm	prod 32 pcs	prod 48 pcs	prod 96 pcs	Extractor	Cutter
Ø 25	25	MIGNON A009	MIGNON B009	MIGNON C009	ED 9	TPM 9



# FORME SPECIALI SPECIAL SHAPES

## FETTA SLICE



mm	h mm	ml	2 barre	3 barre	7 barre
117x62	40	150	MONOP. A0016	MONOP. B0016	MONOP. C0016
117x62	30	112	MONOP. A016	MONOP. B016	MONOP. C016

12 fette/slices = 1 torta/cake Ø24cm

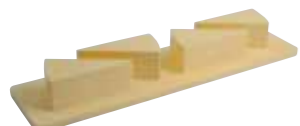

**Extractor**  
**EM 16**  
Non inclusi  
Not included



**Cutter**  
**TPG16**  
Non inclusi  
Not included



**Acetato - Acetate tape**  
**NSA62X117**  
Non inclusi - Not included  
Pretagliato e prefustellato  
Precut and pre die cut  
Pack 500 pcs



## PIRAMID



mm	h mm	2 barre	3 barre	7 barre
70x70	60	PIRAMTP 02	PIRAMTP 03	PIRAMTP 07



## EXTRA

L'articolo include vassoio  
60x40 cm e 7 barre  
The article includes 60x40  
cm tray and 7 moulds  
Prod. 28 dolci / cake

mm	h mm	Cod.	Extractor	Cutter
Ø 80	40	EXTRA C	EEX1	TPEX 1
Ø 75	31	EXTRA C01	EEX01	
Ø 85	31	EXTRA C001	EEX001	



## BI-PORTION

L'articolo include vassoio  
60x40 cm e 5 barre  
The article includes 60x40  
cm tray and 5 moulds  
Prod. 15 dolci / cake

mm	h mm	Cod.	Cutter
Ø 100	45	MONOP. C101	TPB1

## ZUCCOTTO

kit 3 pcs  
**SF 3**

Ø 140 - Ø 160 - Ø 180 mm



# TRONCHETTI LOG MOULDS



**Classic**  
**30TT104S**  
400x100  
h60 mm



**Triangular**  
**ST1**  
480x65  
h 65mm



**Dome**  
**ST2** **ST4**  
480x65  
h 50mm 480x50  
h 40mm



**Fancy**  
**ST3**  
480x65  
h 50mm



**Tappeto silicone**  
**Silicone mat sheets**  
**30TS000**  
360x163mm



**Fogli acetato**  
**Acetate sheets**  
**NSA36X16**  
360x163mm  
50 fogli - sheets



**Stampi per inserti**  
**Moulds for inserts**  
**30TB3S**  
Kit 2 stampi plastica.  
2 plastic moulds kit.  
35x180 h30 mm



# Semifreddo Mats

I nuovi tappeti in silicone per semifreddo sapranno arricchire i vostri tronchetti. Le ormai note caratteristiche di questo materiale rendono possibile un'ottimale sformatura del semifreddo donando al dessert decori di grande effetto.

The new silicone mats for semifreddos will enrich your log-shaped dessert. The well-known features of this material ensure easy removal of the semifreddo from the mould, creating impressive decorations.



**Arabic**  
**30TS001**  
Tappeto - mat 36x16 cm



**Floreal**  
**30TS002**  
Tappeto - mat 36x16 cm



**O'Clock**  
**30TS003**  
Tappeto - mat 36x16 cm



**Flower**  
**30TS004**  
Tappeto - mat 36x16 cm



**Medieval**  
**30TS005**  
Tappeto - mat 36x16 cm



**Stone**  
**30TS006**  
Tappeto - mat 36x16 cm



**Waves**  
**30TS007**  
Tappeto - mat 36x16 cm



**Holly**  
**30TS008**  
Tappeto - mat 36x16 cm



**Snowflake**  
**30TS009**  
Tappeto - mat 36x16 cm



**Comet**  
**30TS010**  
Tappeto - mat 36x16 cm



**Brick**  
**30TS012**  
Tappeto - mat 36x16 cm



**Margherite**  
**30TS018**  
Tappeto - mat 36x16 cm

Teglie in plastica e accessori vari vedi pg precedenti  
Plastic trays and various accessories see previous pg



**Teglia per tronchi**  
**Log-shaped cake tray**  
**30TT104S**  
10x40cm  
80x355 h60 mm



**11H4L36**  
Stainless steel band  
36x16,5 h4 cm

**11H5L36**  
Stainless steel band  
36x16,5 h5 cm



Stampi in plastica per decorazioni - Plastic moulds for decorations



**Arabic**  
**20TES001**  
Prod. 12 pcs



**Floreal**  
**20TES002**  
2 Prod. 12 pcs



**O'Clock**  
**20TES003**  
2 Prod. 12 pcs



**Flower**  
**20TES004**  
2 Prod. 12 pcs



**Medieval**  
**20TES005**  
2 Prod. 12 pcs



**Stone**  
**20TES006**  
Prod. 12 pcs



**Waves**  
**20TES007**  
Prod. 12 pcs



# semi freddo 360°

Martellato inventa un nuovo sistema per produrre semifreddi a forma di cilindro. Un'inedita concezione che aiuta il pasticcere a presentare dessert di grande effetto e al tempo stesso supporta l'operatore durante il processo produttivo.

Martellato invents a new system to prepare cylinder-shaped semifreddos. An original concept that helps the pastry chef to make impressive dessert and at the same time supports the expert during the preparation process.

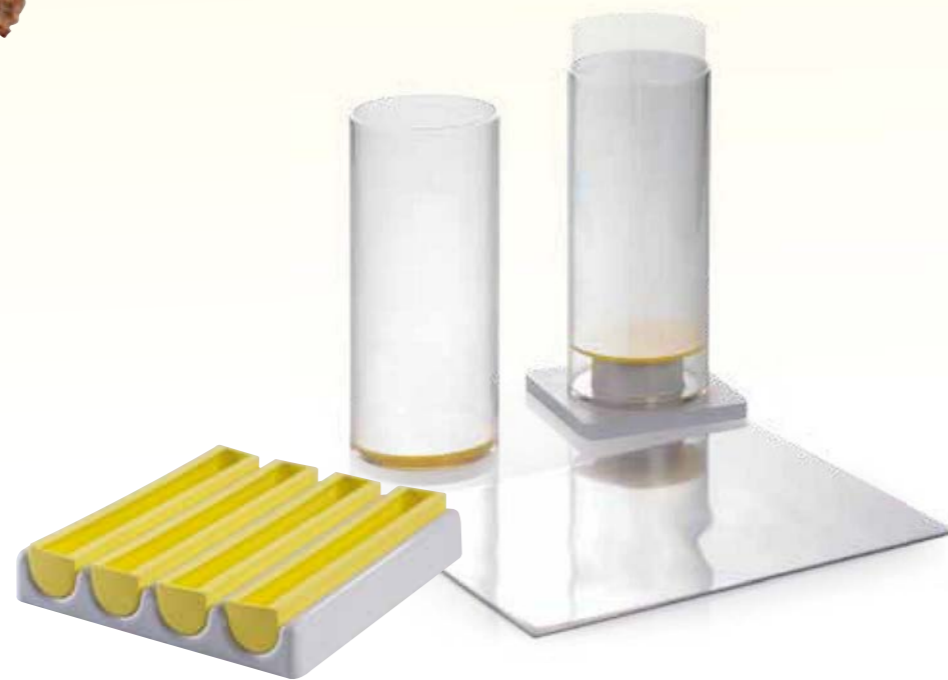

## Starter kit 30TC001K

- 2 Stampi cilindro - Cylinder moulds
- 1 Estrattore - Extractor
- 4 Stampi in silicone per inserti  
Silicone moulds to create insert
- 10 fogli di acetato - acetate sheets

Lo Starter Kit è composto da due stampi in plastica a forma di cilindro, due tappi gialli necessari prima per non far fuoriuscire il composto e poi per rendere possibile la sformatura. Inoltre, per agevolare l'estrazione, la confezione include anche dei fogli di acetato trasparente tagliato in misura da adagiare nella parete interna del cilindro e un estrattore di plastica.

The Starter Kit includes two plastic cylinder-shaped moulds, two yellow stoppers that are necessary first not to let the mixture coming out, then to make demoulding possible. Moreover, to facilitate the extraction the package also includes transparent acetate sheets to be put inside the cylinder and a plastic extractor.

## Stampi cilindro - Cylinder moulds

### 30TC0016

Composto da / Contains:  
6 Stampi - moulds  
Ø 85 h 200 mm  
(inclusi 6 tappi gialli  
including 6 yellow stoppers)

1 Estrattore - Extractor



## set 8 Fogli decorati - 8 Decorated sheets

### 30TCDECO1K

200x267mm  
pack 2 x 4 fogli / sheets



## Nastri acetati - Acetate sheets

### NSA27X20

200x267mm  
pack 50 fogli / sheets

## Stampi in plastica decorazioni Plastic mould for decorations

### 20TEC1K

4 pcs



## Stampi per inserti - Inserts moulds

### 30TB4S

Kit 4 stampi silicone per inserti con teglia di sostegno in plastica.  
4 silicone moulds kit for inserts, with plastic support tray.  
Ø30 x194 mm

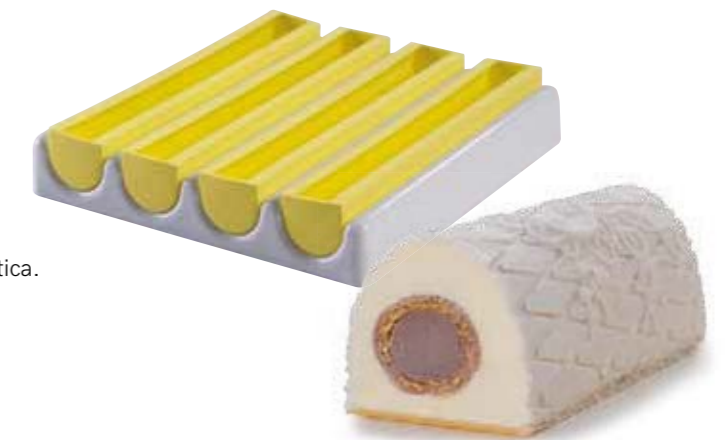



# FASCE ACCIAIO INOX STAINLESS STEEL BANDS

Le fasce inox si prestano sia al congelamento che all'utilizzo in forno, dove assicurano una cottura uniforme.

La varietà di forme e dimensioni, unita alle ampie possibilità di personalizzazione del soggetto su richiesta, rendono le fasce Martellato delle soluzioni versatili in grado di soddisfare anche i pasticceri più esigenti.

The stainless steel cake bands are freezer and oven safe and ensure even cooking. The variety of shapes and sizes, combined with the wide customization opportunities upon request, make Martellato rings very versatile products able to satisfy even the most demanding pastry chefs.

Tondo Round



Size	h 20
Ø 80	1H2X8
Ø 100	1H2X10
Ø 120	1H2X12
Ø 140	1H2X14
Ø 160	1H2X16
Ø 180	1H2X18
Ø 200	1H2X20
Ø 220	1H2X22
Ø 240	1H2X24
Ø 260	1H2X26
Ø 280	1H2X28
Ø 300	1H2X30

Tondi - Misure speciali Round - Special size



Size	h 50
Ø 195	40-W087
Ø 295	40-W088
Ø 395	40-W089
Ø 495	40-W090

Ideali per tamburi vedi pg 350  
Ideal for dummies see page 350

Tondo Round



Size	h 40	h 50
Ø 100	1H4X10	1H5X10
Ø 120	1H4X12	1H5X12
Ø 140	1H4X14	1H5X14
Ø 160	1H4X16	1H5X16
Ø 180	1H4X18	1H5X18
Ø 200	1H4X20	1H5X20
Ø 220	1H4X22	1H5X22
Ø 240	1H4X24	1H5X24
Ø 260	1H4X26	1H5X26
Ø 280	1H4X28	1H5X28
Ø 300	1H4X30	1H5X30

Ovale Oval



Size	h 40	h 50
115x85	2H4X10	2H5X10
135x100	2H4X12	2H5X12
160x120	2H4X14	2H5X14
185x135	2H4X16	2H5X16
205x155	2H4X18	2H5X18
225x175	2H4X20	2H5X20
253x190	2H4X22	2H5X22
270x210	2H4X24	2H5X24
300x220	2H4X26	2H5X26
320x250	2H4X28	2H5X28
345x260	2H4X30	2H5X30

Esagonale Hexagonal

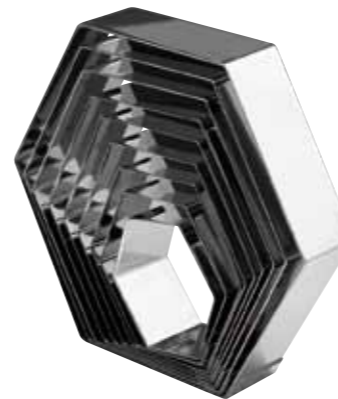

Size	h 40	h 50
175x200	3H4X10	3H5X10
195x220	3H4X11	3H5X11
210x240	3H4X12	3H5X12
235x255	3H4X13	3H5X13
245x280	3H4X14	3H5X14
90x100	3H4X5	3H5X5
125x140	3H4X6	3H5X6
120x140	3H4X7	3H5X7
140x160	3H4X8	3H5X8
160x180	3H4X9	3H5X9

Triangolare Triangular



Size	h 40	h 50
90x100	4H4X10	4H5X10
105x120	4H4X12	4H5X12
120x140	4H4X14	4H5X14
140x160	4H4X16	4H5X16
158x180	4H4X18	4H5X18
175x200	4H4X20	4H5X20
200x230	4H4X23	4H5X23
220x250	4H4X25	4H5X25

Quadrato Square



Size	h 40	h 50
102x102	5H4X10	5H5X10
122x122	5H4X12	5H5X12
142x142	5H4X14	5H5X14
162x162	5H4X16	5H5X16
182x182	5H4X18	5H5X18
202x202	5H4X20	5H5X20
222x222	5H4X22	5H5X22
242x242	5H4X24	5H5X24
262x262	5H4X26	5H5X26
282x282	5H4X28	5H5X28
302x302	5H4X30	5H5X30

Cuore Heart

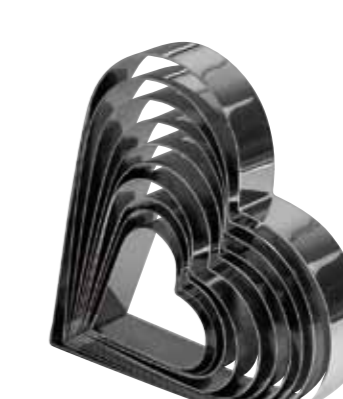

Size	h 40	h 50
115x115	7H4X10	7H5X10
140x130	7H4X12	7H5X12
160x150	7H4X14	7H5X14
175x165	7H4X16	7H5X16
185x200	7H4X18	7H5X18
213x205	7H4X20	7H5X20
235x210	7H4X22	7H5X22
260x240	7H4X24	7H5X24
283x255	7H4X26	7H5X26
300x278	7H4X28	7H5X28





**Goccia Drop**



Size	h 40	h 50
130x82	8H4X10	8H5X10
155x100	8H4X12	8H5X12
175x115	8H4X14	8H5X14
205x127	8H4X16	8H5X16
225x146	8H4X18	8H5X18
250x165	8H4X20	8H5X20
270x180	8H4X22	8H5X22
300x196	8H4X24	8H5X24
325x210	8H4X26	8H5X26
330x255	8H4X28	8H5X28
355x270	8H4X30	8H5X30

**Virgola Comma**



Size	h 40	h 50
138x102	9H4X10	9H5X10
170x105	9H4X12	9H5X12
192x145	9H4X14	9H5X14
215x165	9H4X16	9H5X16
235x180	9H4X18	9H5X18
255x190	9H4X20	9H5X20
295x220	9H4X22	9H5X22
312x240	9H4X24	9H5X24
345x240	9H4X26	9H5X26
375x265	9H4X28	9H5X28

**Rettangolare Rectangular**

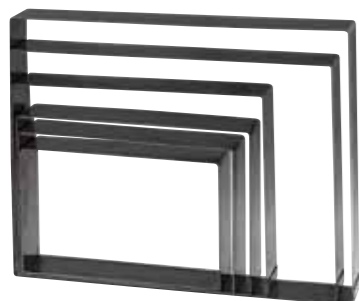

Size	h 40	h 50
243x142	11H4L24	11H5L24
263x164	11H4L26	11H5L26
268x201	11H4L27	11H5L27
282x183	11H4L28	11H5L28
302x222	11H4L30	11H5L30
360x165	11H4L36	11H5L36
382x262	11H4L38	11H5L38
403x320	11H4L40	11H5L40

**Fiore Flower**



Size	h 40	h 50
90x90	12H4X10	12H5X10
106x106	12H4X12	12H5X12
130x130	12H4X14	12H5X14
150x150	12H4X16	12H5X16
175x175	12H4X18	12H5X18
193x193	12H4X20	12H5X20
217x217	12H4X22	12H5X22
237x237	12H4X24	12H5X24
257x257	12H4X26	12H5X26
275x275	12H4X28	12H5X28
300x300	12H4X30	12H5X30

## CUORI - HEARTS



**Cuori doppi - Double hearts**

Size	h 40	h 50
180x105	16H4X18	16H5X18
217x128	16H4X21	16H5X21
280x165	16H4X28	16H5X28



**Cuore con freccia - Heart with arrow**

Size	h 40	h 50
175x155	17H4X17	17H5X17
218x194	17H4X21	17H5X21
280x249	17H4X28	17H5X28



**Cuore - Heart**

Size	h 40	h 50
175x180	18H4X17	18H5X17
200x206	18H4X20	18H5X20
260x268	18H4X26	18H5X26

## NATALE - CHRISTMAS



**Stella cometa - Comet**

Size	h 40
150x65	13H4X15
220x95	13H4X23
320x125	13H4X30



**Albero Natale - Christmas tree**

Size	h 40
158x125	14H4X16
210x165	14H4X20
240x190	14H4X24
300x235	14H4X30

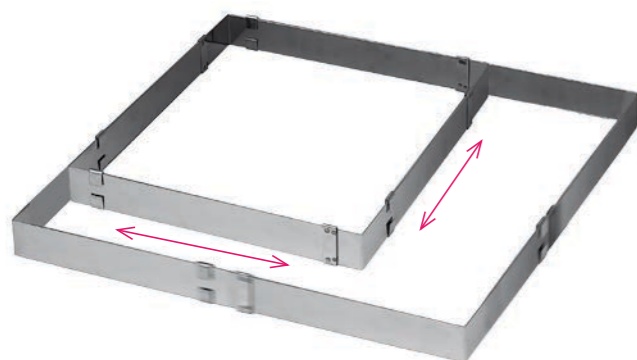

**Rettangolare speciale Special Rectangular**

Min. Size	Max Size	h 40	h 50
305x305	570x560	RETSPECIAL 1	RETSPECIAL 2

Telaio regolabile in lunghezza ed in larghezza.  
Extendable st. steel frame, length and width adjustable.

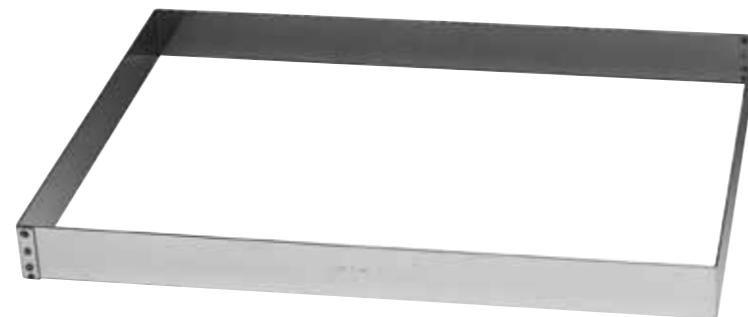

**Rettangolare grande Big Rectangular**

Size	h 40	h 50
380x580	RETH4	RETH5



## PASQUA - EASTER



**Colomba - Dove**

Size	h 40
250x140	15H4X25
300x160	15H4X30
340x180	15H4X34



**Uovo - Egg**

Size	h 40
121x180	27H4X12
134x200	27H4X13
148x220	27H4X14
161x240	27H4X16



**Campana - Bell**

Size	h 40
158x200	28H4X15
181x230	28H4X18
205x260	28H4X20



**Coniglio - Rabbit**

Size	h 40
98x200	29H4X09
112x230	29H4X11
127x260	29H4X12



# FORME FANTASIA - FANCY SHAPES



**Fancy 23**

Size	h 20	h 40	h 50
250x90	<b>23H2X25</b>	<b>23H4X25</b>	<b>23H5X25</b>
300x91	<b>23H2X30</b>	<b>23H4X30</b>	<b>23H5X30</b>
350x92	<b>23H2X35</b>	<b>23H4X35</b>	<b>23H5X35</b>



**Fancy 20**

Size	h 20	h 40	h 50
160x60	<b>20H2X16</b>	<b>20H4X16</b>	<b>20H5X16</b>
211x61	<b>20H2X21</b>	<b>20H4X21</b>	<b>20H5X21</b>
262x62	<b>20H2X26</b>	<b>20H4X26</b>	<b>20H5X26</b>
313x63	<b>20H2X31</b>	<b>20H4X31</b>	<b>20H5X31</b>



**Fancy 21**

Size	h 20	h 40	h 50
200x100	<b>21H2X20</b>	<b>21H4X20</b>	<b>21H5X20</b>
251x101	<b>21H2X25</b>	<b>21H4X25</b>	<b>21H5X25</b>
302x102	<b>21H2X30</b>	<b>21H4X30</b>	<b>21H5X30</b>
353x103	<b>21H2X35</b>	<b>21H4X35</b>	<b>21H5X35</b>



**Fancy 19**

Size	h 20	h 40	h 50
250x60	<b>19H2X25</b>	<b>19H4X25</b>	<b>19H5X25</b>
300x61	<b>19H2X30</b>	<b>19H4X30</b>	<b>19H5X30</b>



**Fancy 22**

Size	h 40	h 50
360x100	<b>22H4X36</b>	<b>22H5X36</b>
239x99	<b>22H4X23</b>	<b>22H5X23</b>



**Fancy 24**

Size	h 40	h 50
150x150	<b>24H4X15</b>	<b>24H5X15</b>
200x200	<b>24H4X20</b>	<b>24H5X20</b>
250x250	<b>24H4X25</b>	<b>24H5X25</b>



**Fancy 25**

Size	h 40	h 50
150x150	<b>25H4X15</b>	<b>25H5X15</b>
200x200	<b>25H4X20</b>	<b>25H5X20</b>
250x250	<b>25H4X25</b>	<b>25H5X25</b>



**Zucca - Pumpkin**

Size	h 40
146x114	<b>26H4X14</b>
148x132	<b>26H4X15</b>
237x225	<b>26H4X23</b>



**Fetta dolce - Cake slice**

Size	h 40	h 50
117x61	<b>31H4X11</b>	<b>31H5X11</b>



**Numeri - Numbers**

Nr	Size	h 40
0	200x160	<b>30H4X10</b>
1	200x93	<b>30H4X01</b>
2	200x160	<b>30H4X02</b>
3	200x160	<b>30H4X03</b>
4	200x170	<b>30H4X04</b>
5	200x160	<b>30H4X05</b>
6	200x160	<b>30H4X06</b>
7	200x160	<b>30H4X07</b>
8	200x160	<b>30H4X08</b>
9	200x160	<b>30H4X09</b>



# i MICROFORATI

x 2 stampi silicone **30x40** size  
silicone moulds **misura**

Una linea di prodotti per cotture in forno, realizzata in silicone e fibra di vetro, per facilitare il lavoro in laboratorio. Le caratteristiche che li contraddistinguono, come l'alta qualità dei materiali e la texture microforata, consentono la diffusione uniforme del calore e l'uscita dell'umidità, riducendo i tempi di cottura e garantendo un risultato perfetto. Tante forme ideali per le diverse preparazioni sia dolci che salate, come tartellette classiche e moderne, brioche e muffin. Le creazioni risulteranno perfettamente croccanti e con la forma perfetta, senza bolle o cedimenti. Ideali anche per i lievitati, pasta frolla e brisée. I tappeti sono antiaderenti e possono essere usati da entrambi i lati, per preparare tartellette vuote o già farcite.

A new line of products for oven cooking, made of silicone and fiberglass, to facilitate the work in the laboratory. The features that distinguish them, such as high-quality materials and micro-perforated texture, allow uniform diffusion of the heat and the moisture output, reducing cooking times and ensuring a perfect result. Many shapes ideal for different sweet and savory preparations, such as classic and modern tartlets, brioche and muffin. The creations will be crisp and perfect, without bubbles or cracks. Ideal also for leavened products, short pastry and brisée. Mats are non-stick and can be used on both sides to prepare empty or stuffed tartlets.



**Tondi - Round**  
**30MICRO01**

Ø40 - h16mm Prod: 24 +24 pcs



**Tondi - Round**  
**30MICRO02**

Ø50 - h16mm Prod: 20 +20 pcs



**Tondi - Round**  
**30MICRO03**

Ø60 - h40mm Prod: 12 +12 pcs



**Tondi - Round**  
**30MICRO04**

Ø85 - h20mm Prod: 6 +6 pcs



**Tondi - Round**  
**30MICRO05**

Ø120 - h30mm Prod: 4 +4 pcs

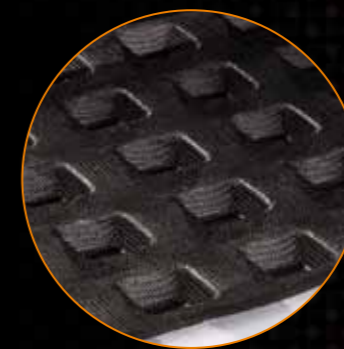

**Quadrati - Square**  
**30MICRO06**

35x35 - h16mm Prod: 30 +30 pcs



**Quadrati - Square**  
**30MICRO07**

50x50 - h20mm Prod: 20 +20 pcs



**Quadrati - Square**  
**30MICRO08**

85x85 - h20mm Prod: 6 +6 pcs



**Triangolo - Triangle**  
**30MICRO09**

Side 60 - h25mm Prod: 15 +15 pcs



**Tondi - Round**  
**30MICRO10**

Ø 48 - h22mm Prod: 20 + 20 pcs

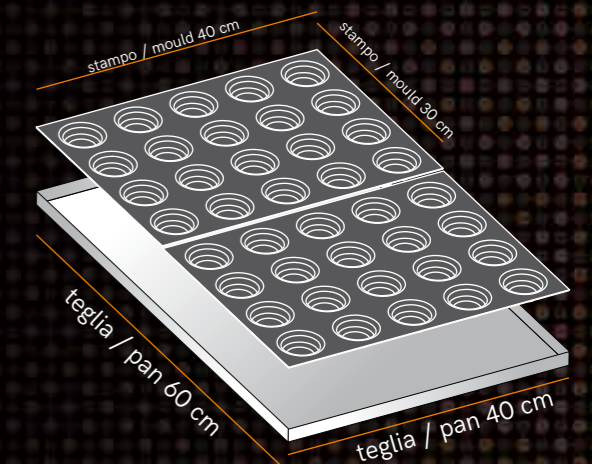



# TARTELLETTE TARTLET MOULDS

Stampi in alluminio 10/10  
10/10 Aluminum moulds



Tortine svasate - Flared little cakes



- 30TA01090**  
Ø90 h23 - conf. 25pz
- 30TA01070**  
Ø70 h19 - conf. 25pz
- 30TA01050**  
Ø50 h15 - conf. 25pz

Tortina dritta - Straight little cakes

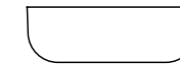

- 30TA02100**  
Ø100 h25 - conf. 25pz
- 30TA02080**  
Ø80 h 21 - conf. 25pz
- 30TA02060**  
Ø60 h17 - conf. 25pz
- 30TA02040**  
Ø40 h13 - conf. 25pz

Tortina barchetta - Boat little cakes

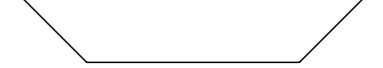

- 30TA03090**  
90x60 h20 - conf. 25pz
- 30TA03080**  
80x50 h 15 - conf. 25pz

Semisfere - Semispheres

- 30TA04070**  
Ø70 h32 - conf. 25pz
- 30TA04060**  
Ø60 h 26 - conf. 25pz
- 30TA04040**  
Ø40 h20 - conf. 25pz



Babà

- 30TA05055**  
Ø55 h60 - conf. 12pz
- 30TA05045**  
Ø45 h50 - conf. 12pz
- 30TA05035**  
Ø35 h40 - conf. 12pz

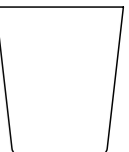



# STAMPI IN SILICONE SILICONE MOULDS



## MULTI FORMA SINGLE SERVING

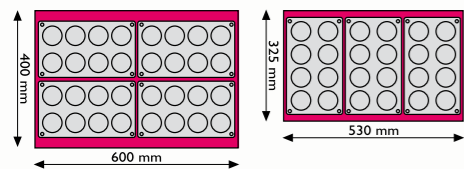

Le teglie in silicone sono disponibili senza imballo: es. cod. SF010/N  
o conf. da 1 pezzo con nylon e cavallotto (logo martellato): es. cod. SF010  
Silicone trays are available without package: ex. cod. SF010/N  
or package of 1 pc with nylon and blister flag (Martellato logo): ex. cod. SF010



**HALF SPHERE**  
SF001  
Ø 80 h 40 mm  
5 fig.

**HALF SPHERE**  
SF002  
Ø 70 h 35 mm  
6 fig.

**HALF SPHERE**  
SF003  
Ø 60 h 30 mm  
6 fig.



**HALF SPHERE**  
SF004  
Ø 50 h 25 mm  
8 fig.

**HALF SPHERE**  
SF005  
Ø 40 h 20 mm  
15 fig.

**HALF SPHERE**  
SF006  
Ø 30 h 15 mm  
24 fig.

**PIRAMIDE - PYRAMID**  
SF007  
71x71 h 40 mm  
6 fig.

**PIRAMIDE - PYRAMID**  
SF008  
36x36 h 22 mm  
15 fig.

**POMPONETTE**  
SF009  
Ø 34 h 16 mm  
24 fig.



**SAVARIN**  
SF010  
Ø 41 h 12 mm  
18 fig.

**SAVARIN**  
SF011  
Ø 65 h 21 mm  
8 fig.

**SAVARIN**  
SF012  
Ø 72 h 23 mm  
6 fig.

**TARTELETTA - TARTLET**  
SF013  
Ø 45 h 10 mm  
15 fig.

**TARTELETTA - TARTLET**  
SF014  
Ø 50 h 15 mm  
15 fig.

**TARTELETTA - TARTLET**  
SF015  
Ø 60 h 17 mm  
8 fig.

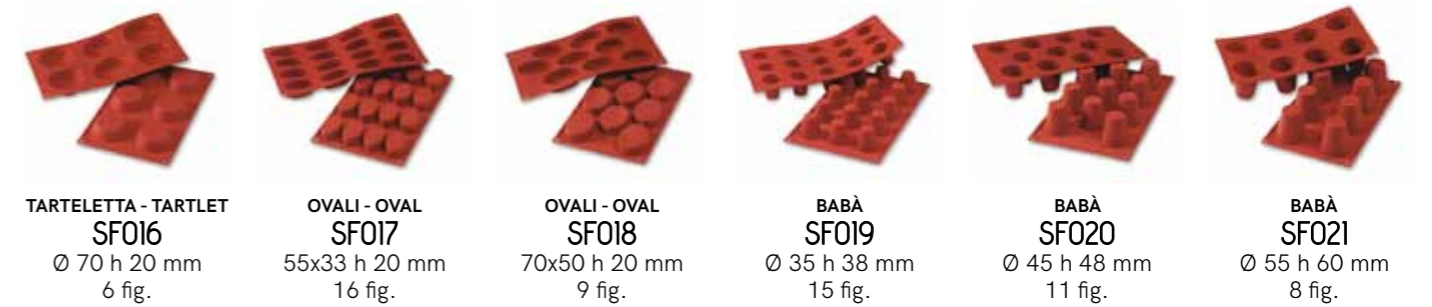

**TARTELETTA - TARTLET**  
SF016  
Ø 70 h 20 mm  
6 fig.

**OVALI - OVAL**  
SF017  
55x33 h 20 mm  
16 fig.

**OVALI - OVAL**  
SF018  
70x50 h 20 mm  
9 fig.

**BABÀ**  
SF019  
Ø 35 h 38 mm  
15 fig.

**BABÀ**  
SF020  
Ø 45 h 48 mm  
11 fig.

**BABÀ**  
SF021  
Ø 55 h 60 mm  
8 fig.



**MUFFIN**  
SF022  
Ø 51 h 28 mm  
11 fig.

**MUFFIN**  
SF023  
Ø 69 h 35 mm  
6 fig.

**MUFFIN**  
SF024  
Ø 81 h 32 mm  
5 fig.

**FINANZIERE**  
SF025  
49x26 h 11 mm  
20 fig.

**CAKE**  
SF026  
79x29 h 30 mm  
12 fig.

**PETITE FOUR**  
SF027  
Ø 40 h 20 mm  
15 fig.

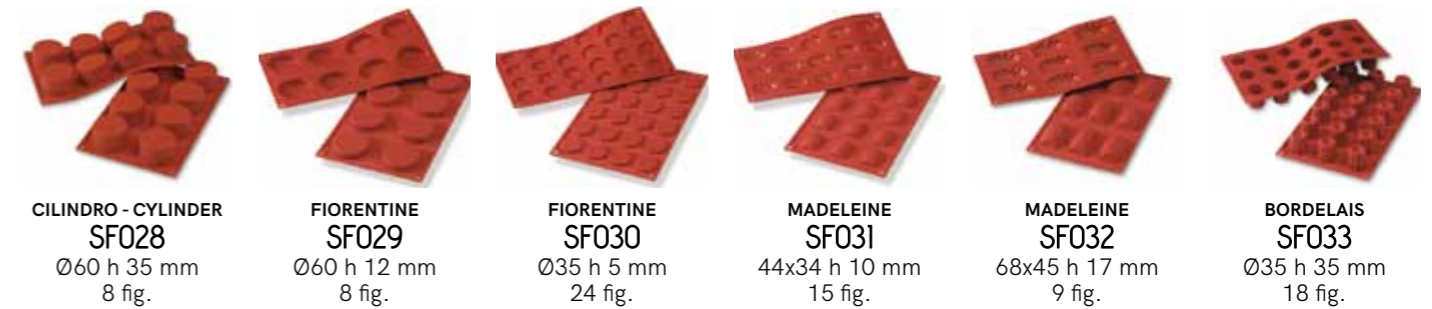

**CILINDRO - CYLINDER**  
SF028  
Ø 60 h 35 mm  
8 fig.

**FIORENTINE**  
SF029  
Ø 60 h 12 mm  
8 fig.

**FIORENTINE**  
SF030  
Ø 35 h 5 mm  
24 fig.

**MADELEINE**  
SF031  
44x34 h 10 mm  
15 fig.

**MADELEINE**  
SF032  
68x45 h 17 mm  
9 fig.

**BORDELAIS**  
SF033  
Ø 35 h 35 mm  
18 fig.



**BRIOCHETTE**  
SF034  
79 h 37 mm  
6 fig.

**BRIOCHETTE**  
SF035  
Ø 79 h 30 mm  
6 fig.

**CUORE - HEART**  
SF036  
Ø 65 h 60 mm  
6 fig.

**OTTAGONO - OCTAGON**  
SF037  
Ø 38 h 26 mm  
15 fig.

**BARCHETTA - BOAT**  
SF038  
72x30 h 15 mm  
12 fig.

**BARCHETTA - BOAT**  
SF039  
100x44 h 15 mm  
9 fig.



**CUORE - HEART**  
SF040  
Ø 60 h 35 mm  
8 fig.

**HALF EGG**  
SF041  
102x73 h 36 mm  
5 fig.

**DISCO - SPONGE BASE**  
SF042  
Ø 103 h 13 mm  
15 fig.

**TORTINA - FLAN**  
SF043  
Ø 40 h 13 mm  
15 fig.

**TORTINA - FLAN**  
SF044  
Ø 50 h 14 mm  
15 fig.

**TORTINA - FLAN**  
SF045  
Ø 60 h 17 mm  
8 fig.





**TORTINA - FLAN SF046**  
Ø70 h 17 mm  
6 fig.

**TORTINA - FLAN SF047**  
Ø80 h 18 mm  
6 fig.

**DIAMANTE - DIAMOND SF048**  
Ø35 h 23 mm  
18 fig.

**DIAMANTE - DIAMOND SF049**  
Ø68 h 45 mm  
6 fig.

**BORDELAIS SF050**  
Ø55 h 50 mm  
8 fig.

**BAVARESE SF051**  
Ø57 h 57 mm  
8 fig.



**MUFFIN SF052**  
Ø75 h 60 mm  
6 fig.

**KRAPFEN SF053**  
Ø60 h 20 mm  
6 fig.

**FINANZIERE SF054**  
95x45 h 12 mm  
7 fig.

**OVALI - OVAL SF055**  
75x55 h 35 mm  
8 fig.

**MARGUERITE SF056**  
Ø70 h 28 mm  
6 fig.

**GUGELHOPF SF057**  
Ø55 h 36 mm  
8 fig.



**GUGELHOPF SF058**  
Ø70 h 36 mm  
6 fig.

**BORDELAIS SF059**  
Ø45 h 45 mm  
18 fig.

**TORRONCINI - NOUGAT SF060**  
50x25 h 20 mm  
20 fig.

**MIX SF061**  
Ø75 h 40 mm  
2x3 fig.

**MUFFIN GRANDE SF102**  
Ø68 h 38 mm  
6 fig.

**SAVOIARDO SF103**  
127,5x47 h 17 mm  
6 fig.



**MINI BRIOCHETTE SF109**  
Ø58 h 22 mm  
6 fig.

**MARSIGLIESE SF114**  
95x35 h 25 mm  
7 fig.

**WAFFLE CLASSIC SF155**  
130x81 h 17 mm  
4 fig.

**DONUTS SF170**  
Ø75/25 h 28 mm  
6 fig.

**PASTILLE SF180**  
Ø27 h 11 mm  
40 fig.



Con i taglia pasta su misura la preparazione dei vostri prodotti sarà ancora più facile e rapida.

Preparing your best products will be even easier and faster using our dough cutters.



**cutter per SF014 CUTTER 50**

**cutter per SF047 CUTTER 80**

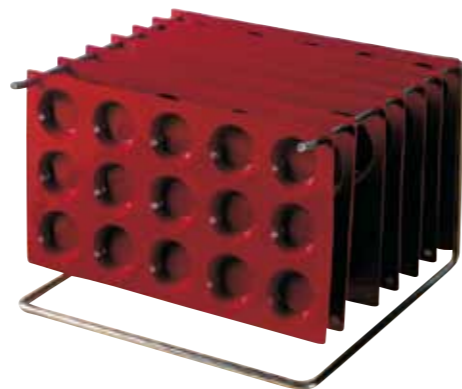

**Sostegno per teglie Support to tray**

**DRIP**

In acciaio inox per sgocciolare le teglie  
Stainless steel support to leave the tray dry.

# TORTIERE BAKING TIN



Non usare l'anello in microonde.  
The ring cannot be used in the microwave.



**SMALL STAR SFT 201/Y**  
Ø 260 h 40 mm

**BIG STAR SFT 202/Y**  
Ø 260 h 50 mm

**PINO - TREE SFT 203/Y**  
280x200 h 40 mm

**ORSETTO - TEDDY BEAR SFT 204/Y**  
290x200 h 60 mm

**CUORE - HEART SFT 210/Y**  
220x218 h 30 mm

**MARGUERITE SFT 220/Y**  
Ø220 h 45 mm



**CIAMBELLA - SAVARIN SFT 224/Y**  
Ø240 h 60 mm

**PIZZA SFT 228/Y**  
Ø280 h 20 mm

**GUGELHOPF SFT 250/Y**  
Ø220 h 110 mm

**ROSA - ROSE SFT 251/Y**  
Ø220 h 100 mm

**SUNFLOWER SFT 252/Y**  
Ø260 h 70 mm

**RECTANGULAR SFT 300/Y**  
280x220 h 40 mm



**DAISY PAN SFT 302/Y**  
280x215 h 50 mm

**TRY ME SFT 514/Y**  
Ø140 h 50 mm

**BRIOCHE SFT 522/Y**  
Ø220 h 80 mm

**STAR BUNDT SFT 600/Y**  
Ø240 h 100 mm

**FIORE - FLOWER SFT 722/Y**  
Ø220 h 100 mm

**BRIOCHE SFT 726/Y**  
Ø260 h 80 mm



**PLUM CAKE SFT 730/Y**  
300x145 h 80 mm

**PLUM CAKE SFT 326/Y**  
240x105 h 65 mm

**PLUM CAKE SFT 330/Y**  
260x100 h 70 mm

**CROSTATA - FLAN PAN SFT 424/Y**  
Ø240 h 30 mm

**CROSTATA - FLAN PAN SFT 426/Y**  
Ø260 h 30 mm

**CROSTATA - FLAN PAN SFT 428/Y**  
Ø280 h 30 mm



**TONDO - ROUND SFT 118/Y**  
Ø180 h 40 mm

**TONDO - ROUND SFT 120/Y**  
Ø200 h 40 mm

**TONDO - ROUND SFT 122/Y**  
Ø220 h 42 mm

**TONDO - ROUND SFT 124/Y**  
Ø240 h 42 mm

**TONDO - ROUND SFT 126/Y**  
Ø260 h 45 mm

**TONDO - ROUND SFT 128/Y**  
Ø280 h 47 mm

Imballo nylon trasparente - Transparent packaging



# ATTREZZATURA PER ECLÀIR

## ECLÀIR EQUIPMENT



**Eclair 25x125mm**

**30TE6001R**

Tappeto silicone - Silicone mat 58,5x38,6 cm  
36 pcs

**30TE3001R**

Tappeto silicone - Silicone mat 29,8x39,8 cm  
18 pcs

**Mini Eclair 18x60mm**

**30TE6002R**

Tappeto silicone - Silicone mat 58,5x38,6 cm  
70 pcs

**30TE3002R**

Tappeto silicone - Silicone mat 29,8x39,8 cm  
35 pcs

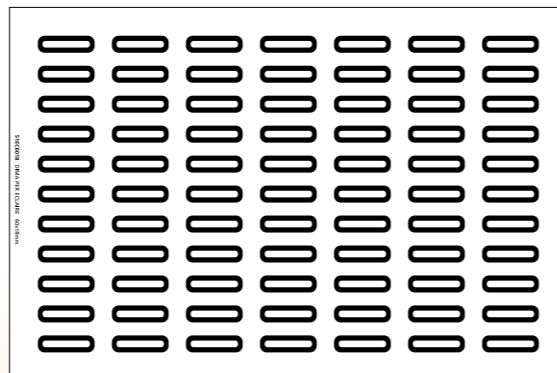
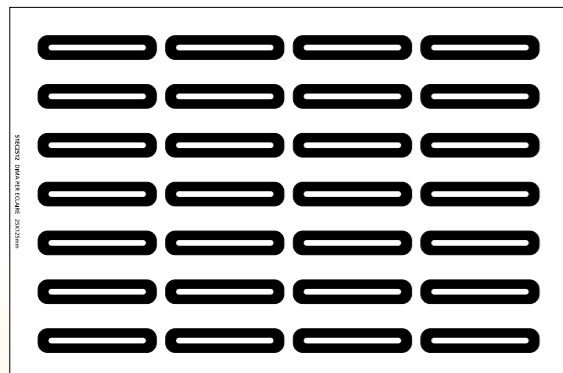

**Eclair 25x125mm**

**51EC2512**

Dima in plastica - Plastic template 59x39 cm  
28 pcs

**Eclair 18x60mm**

**51EC6018**

Dima in plastica - Plastic template 59x39 cm  
77 pcs

Il prodotto va posizionato su foglio di carta da forno, la cui trasparenza permette di vedere dove posizionare l'impasto degli Eclair.  
The product must be placed on grease-proof paper: its transparency allows you to see where to place eclair dough.

**Non adatta alla cottura - Not suitable for cooking**



**Vassoio - Tray**

**50VP00402**

In plexiglass con bordi - Plexiglass with edges  
Size: 140x400mm



**Tagliapasta - Pastry cutter**  
**25x125mm**

**31CUT01**

per decorazione pasta mandorle  
to decorate almond paste



**Tagliapasta - Pastry cutter**  
**18x60mm**

**31CUT02**

per decorazione pasta mandorle  
to decorate almond paste

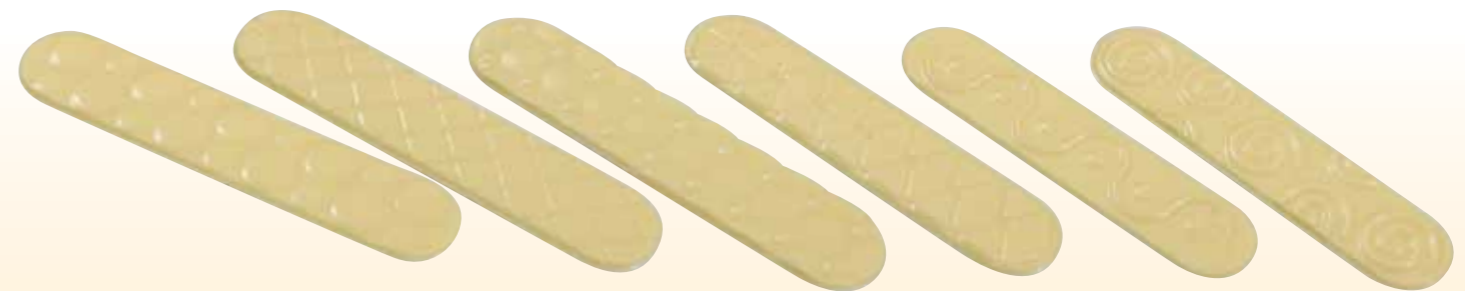

**Eclair 25x125mm**

**20EC01**

Stampi per decorazioni cioccolato  
Moulds for chocolate decorations  
Kit 6 stampi / moulds - prod 36 pcs

**Eclair 18x60mm**

**20EC02**

Stampi per decorazioni cioccolato  
Moulds for chocolate decorations  
Kit 6 stampi / moulds - prod 72 pcs



# ATTREZZATURA PER MACARON MACARON EQUIPMENT



**Macaron Ø40mm**  
**30TM6001R**

Tappeto silicone - Silicone mat 58,5x38,6 cm  
70 gusci/shells

**Macaron Ø40mm**  
**30TM3001R**

Tappeto silicone - Silicone mat 30x40cm  
34 gusci/shells

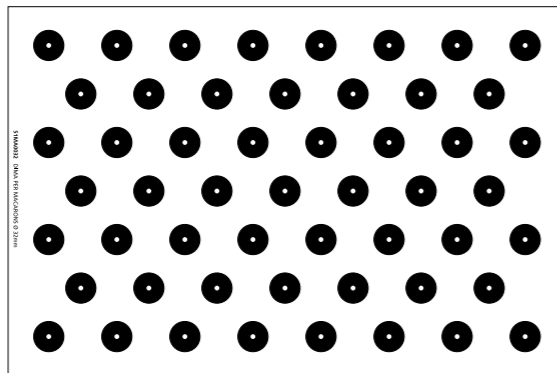

Il prodotto va posizionato su foglio di carta da forno, la cui trasparenza permette di vedere dove posizionare l'impasto dei Macaron.  
The product must be placed on grease-proof paper: its transparency allows you to see where to place macaron dough.



Ampia gamma di espositori per Macaron a pagina 287  
Wide range of macaron displays see page 287



Vedi imballi a pagina 123  
See page 123

**Macaron Ø32mm**  
**51MA0032**

Dima in plastica - Plastic template 59x39 cm  
53 gusci/shells  
**Non adatta alla cottura - Not suitable for cooking**

# STAMPI PER GELATINE JELLY MOULDS

Stampi per gelatine, in puro silicone alimentare, per la realizzazione di gelatine alla frutta, fondenti, ecc. Telaio in plastica.

Silicone moulds for fruit jelly, fondant, etc.  
Plastic frame.

Stampo - Mould: 180x335 mm

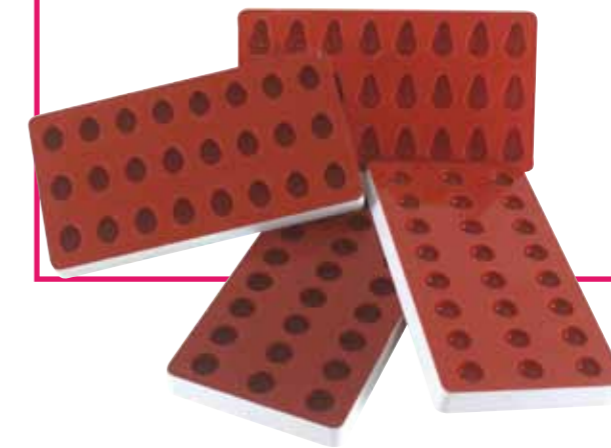

**ORANGE SLICE**  
**SG 01**  
Size:45x18 h 15 mm  
24 fig.



**CUORE - HEART**  
**SG 03**  
Size:34x30 h 18 mm  
24 fig.



**ANANAS - PINEAPPLE**  
**SG 07**  
Size:33x23 h 18 mm  
24 fig.



**STRAWBERRY**  
**SG 08**  
Size:30x30 h 20 mm  
24 fig.



**PESCA - PEACH**  
**SG 09**  
Size:35x25 h 20 mm  
24 fig.



**MORA - BERRY**  
**SG 06**  
Size:Ø30 h 24 mm  
24 fig.



**HALFSPHERE**  
**SG 04**  
Size:Ø27 h 13,5 mm  
24 fig.



**PERA - PEAR**  
**SG 02**  
Size:40x26 h 15 mm  
24 fig.



**BON BON - PASTILLE**  
**SG 05**  
Size:Ø30 h 11 mm  
24 fig.



Colino vedi pg 248  
Piston funnel see pg 248



# ATTREZZATURE PER NATALE CHRISTMAS EQUIPMENT

Stampi pandoro in alluminio  
Aluminium pandoro moulds

- 100 gr**  
**30SP0100**  
Ø 10,8 h 8 cm
- 250 gr**  
**30SP0250**  
Ø 16,5 h 13 cm
- 500 gr**  
**30SP0500**  
Ø 19,5 h 14,5 cm
- 750 gr**  
**30SP0750**  
Ø 20,5 h 15,5 cm
- 1000 gr**  
**30SP1000**  
Ø 23 h 17 cm



**Gingerbread House Cutter**  
**30CH001**  
Acciaio inox - Stainless steel  
120x138 h 140mm

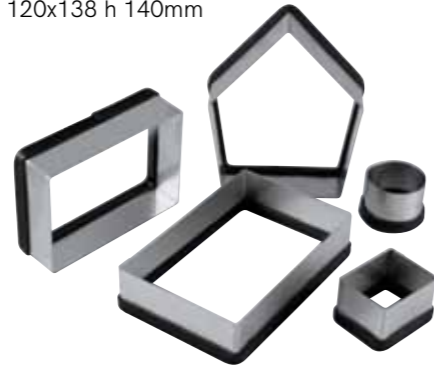

**50GIRA02**  
Asse girapanettoni  
"Panettoni" cake turning rod  
Acciaio inox - Stainless steel  
Misure - size 200 cm

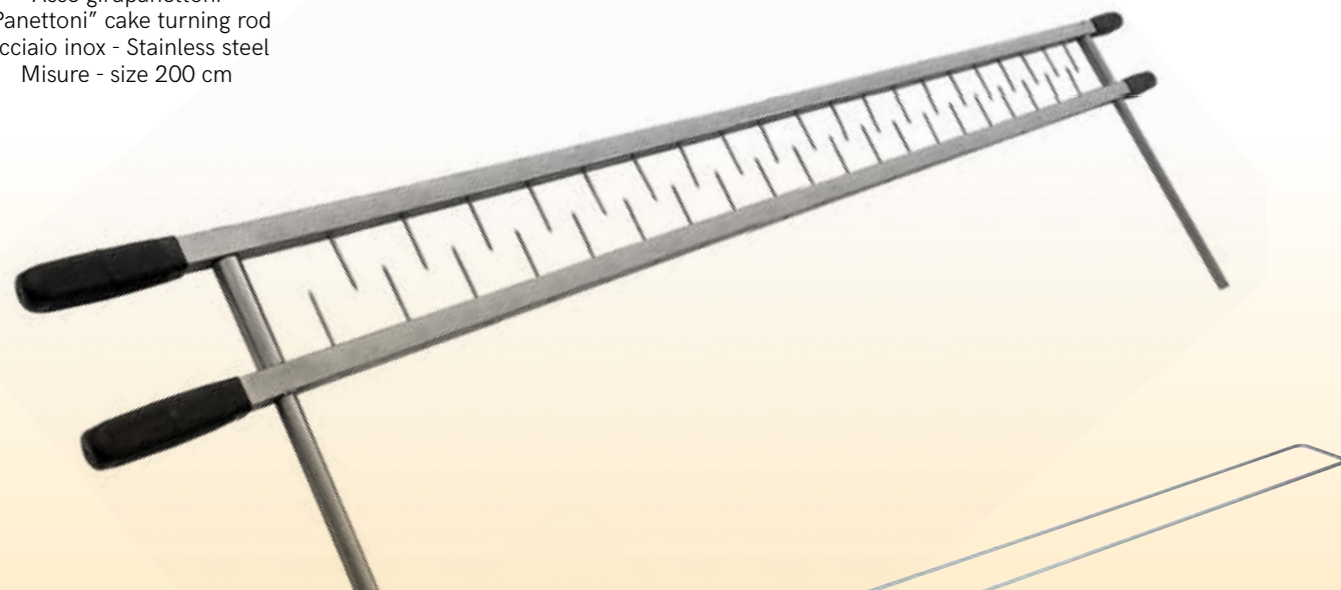

**53GP01**  
Aghi girapanettoni  
Pin to turn "panettoni"  
10 pcs - 60cm

# ACETATI ALIMENTARI FOOD ACETATE

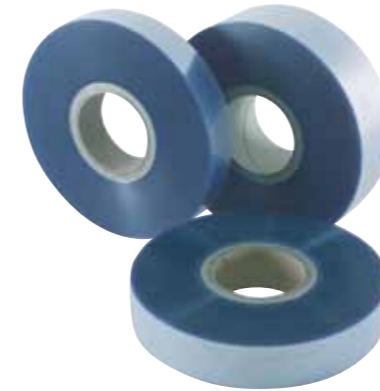

NASTRO - RIBBON  
90MY - 305 MT

h mm	Cod.
25	<b>NSA H 25</b>
30	<b>NSA H 30</b>
35	<b>NSA H 35</b>
40	<b>NSA H 40</b>
45	<b>NSA H 45</b>
50	<b>NSA H 50</b>
55	<b>NSA H 55</b>
60	<b>NSA H 60</b>



NASTRO PRETAGLIATO - PRECUT RIBBON  
90MY

Size mm	Cod.	pcs
40x240	<b>NSA 40X240</b>	1000
30x240	<b>NSA 30X240</b>	1000
25x150	<b>NSA 25X150</b>	1000



FOGLI MORBIDI - SOFT SHEETS  
120MY

Size mm	Cod.	pcs
600x400	<b>NSA60X40MO</b>	50



FOGLI - SHEETS  
90MY

Size mm	Cod.	pcs
200x267	<b>NSA27X20</b>	50
360x163	<b>NSA36X16</b>	50
300x300	<b>NSACM30X30</b>	50
600x400	<b>NSA CM 60X40</b>	50





## GELATO ICE CREAM

WINTER ICE	198
GHIACCIOLOFLEX	200
BABY ICE	202
ICE TUBE	204
ICE DESSERT	206
PUSH UP POPS	208
COOKIE PRO	212
SEGNAGUSTO	
FLAVOUR MARKER	214
SPATOLE GELATO	
ICECREAM SPATULA	220
ACCESSORI/ ACCESSORIES	223



Linea di stampi in plastica ideali per la produzione artigianale di semifreddi e gelati da presentare su stecco in tutte le stagioni. Cinque forme, abbinata al tagliapasta in plastica per tagliare la base di biscuit o pan di spagna, per incontrare i gusti di tutti.

Plastic moulds ideal for the production of handmade desserts and ice creams on a stick, perfect even in winter. Five shapes, combined with the plastic cutter for the biscuit or sponge cake base.

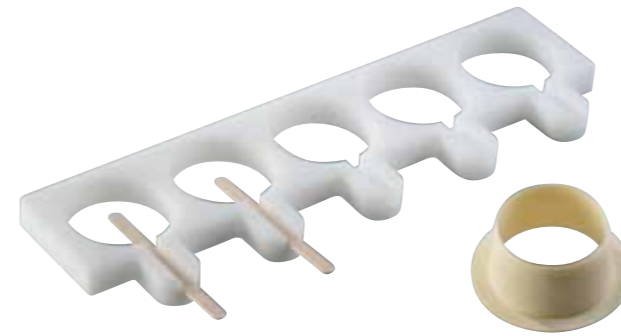

**Tondo - Round**  
**10-W001**  
Semifreddo: Ø65 h20 mm  
Prod: 5 pcs  
Mould: 390x115 h20 mm

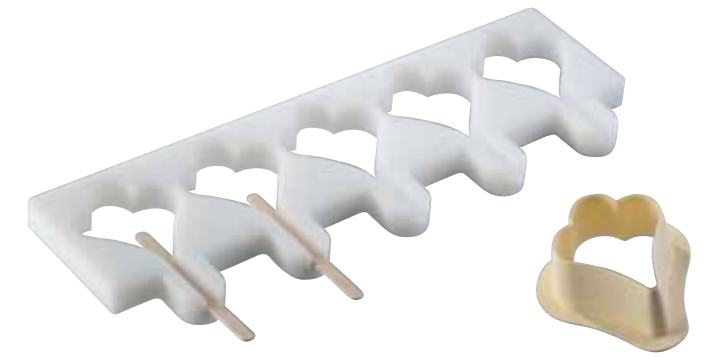

**Ventaglio - Fan**  
**10-W010**  
Semifreddo: 70x85 h20 mm  
Prod: 5 pcs  
Mould: 390x135 h20 mm

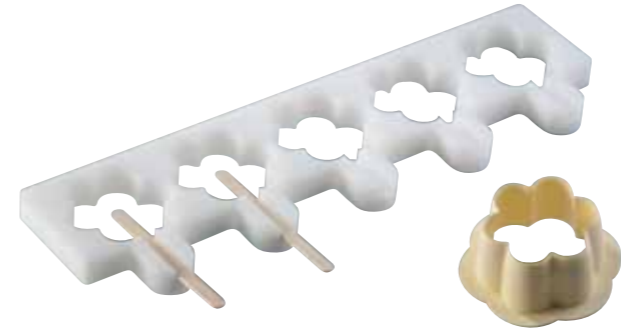

**Fiore - Flower**  
**10-W012**  
Semifreddo: Ø70 h20 mm  
Prod: 5 pcs  
Mould: 390x115 h20 mm

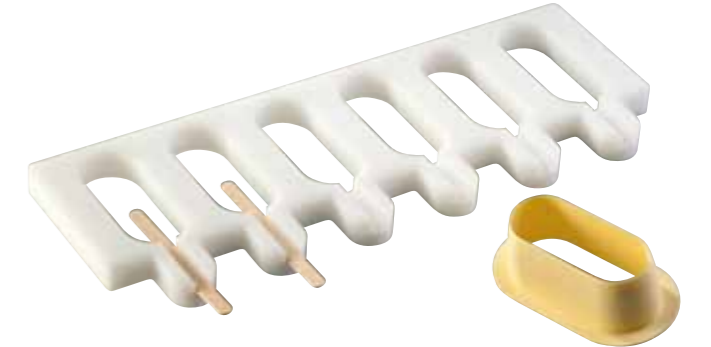

**Oblungo - Oblong**  
**10-W013**  
Semifreddo: 95x40 h20 mm  
Prod: 6 pcs  
Mould: 390x145 h20 mm

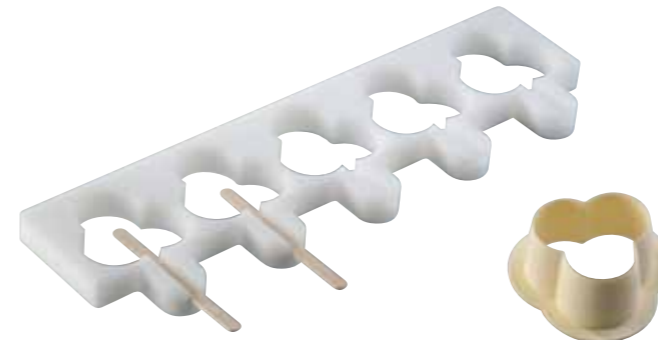

**Trifoglio - Clover**  
**10-W014**  
Semifreddo: 70x70 h20 mm  
Prod: 5 pcs  
Mould: 390x115 h20 mm



**STLG100**  
Stecchi in legno  
Wooden sticks  
50 pcs

## PLEXIGLASS DISPLAYS

**Adatto a banco frigo - Suitable for fridge display counter**

**10-E003**  
Misura - Size: 165x360 h50 mm  
Cap. 16 pcs - 24 pcs oblungo

**10-E004**  
Misura - Size: 245x360 h50 mm  
Cap. 24 pcs - 40 pcs oblungo

**Adatto a vetrina verticale - Suitable for vertical showcase**

**10-E005**  
Misura - Size: 310x250 h110 mm  
Cap. 24 pcs





# GhiaccioloFlex

La rivoluzione dedicata alla produzione artigianale di ghiaccioli su stecco. Lo straordinario materiale plastico utilizzato per la sua produzione lo rende particolarmente flessibile e assolutamente indeformabile.

The revolution dedicated to the artisan production of ice lollies on stick. The extraordinary plastic material selected and used for its production makes it absolutely non-deformable and particularly flexible.



**Heart**  
**105001**  
Prod: 24 pcs  
80/85 gr approx



**Recouvert**  
**105002**  
Prod: 24 pcs  
80/85 gr approx



**Twig**  
**105003**  
Prod: 24 pcs  
80/85 gr approx



**Wave**  
**105000**  
Prod: 24 pcs  
80/85 gr approx

## PLEXIGLASS DISPLAYS

Espositore in plexiglass per vetrina orizzontale  
Plexiglass display for horizontal showcases

**10-E002**  
Misura - Size: 360x250 h50mm  
Cap. 24 pcs

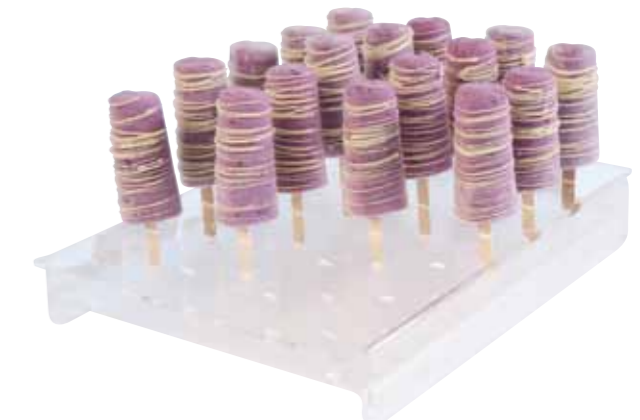



# Baby Ice®

Un ottimale connubio di simpatia delle forme e genuinità degli ingredienti che solo la vera produzione artigianale può offrire. Coloratissimi e freschissimi ghiaccioli si potranno produrre con gli stampi in plastica a forma di animali.

The perfect mix of funny shapes and genuine ingredients that can be provided only by craftsmen.

A kit of plastic moulds to produce colorful and fresh ice-lollies with animals shape.



**SBIKIT01**  
80 pcs (8 mod.x10 pcs)  
bastoncini inclusi - stick included



Cow x10 pcs 65x33 h90mm    Bear x10 pcs 66x28 h87mm    Cat x10 pcs 61x35 h89mm    Mouse x10 pcs 60x35 h80mm    Dog x10 pcs 74x29 h90mm    Pig x10 pcs 53x37 h87mm    Hippo x10 pcs 68x31 h95mm    Chick x10 pcs 85x33 h90mm

**BST100**  
Sticks 100 pcs (mix)



## PLEXIGLASS DISPLAYS



Espositore in plexiglass satinato per vetrina orizzontale  
Glazed plexiglass display for horizontal showcases

**ESPICE14**  
Size: 160x360 h35 mm  
Cap. 14 pcs



Espositore in plexiglass trasparente per vetrina verticale  
Transparent plexiglass display for vertical showcases

**ESPICE21**  
Size: 250x360 h35 mm  
Cap. 21 pcs

**ESPICE**  
Size: 310x250 h110 mm  
Cap. 20 pcs



# IceTube

Uno dei best seller dell'estate si potrà ottenere facilmente con Icetube, il perfetto stampo monouso che funge anche da imballo, per esporre i ghiaccioli in vetrina e da consegnare ai clienti.

One of the summer best seller will be achieved easily with Icetube, the perfect disposable mold which also acts as a packing, to expose the icicles in the window and to be delivered to customers.



**Ice tube**  
**CLP01**  
100 pcs ~150 ml

## PLEXIGLASS DISPLAYS



**Supporto plastica bianca per abbattitore**  
**White plastic holder for blast chiller**  
**CLPESPOB**  
290x390 h120 mm  
28 sedi - holes



**Espositore trasparente vetrina verticale**  
**Transparent display for vertical cabinets**  
**CLPESPOBTRA**  
280x360 h120 mm  
25 sedi - holes



**Espositori satinati per vetrina gelato**  
**Displays for standard ice-cream**  
**CLPESPO21**   **CLPESPO15**  
250x360 h45 mm   160x360 h45 mm  
21 sedi - holes   15 sedi - holes



Gelati, ghiaccioli e sorbetti su stecco saranno facilissimi da realizzare con gli stampi che abbinano la flessibilità del silicone al sostegno della plastica rigida. Con la loro forma arrotondata gli stampi Ice dessert sono ideali anche nella preparazione di splendidi dessert al piatto gelati o semifreddi.

Ice creams, ice lollies and sorbets on a stick will be easy to make with molds that combine the flexibility of silicone with the support of rigid plastic. With their rounded shape the Ice dessert molds are also ideal in the preparation of splendid desserts ice cream or frozen desserts

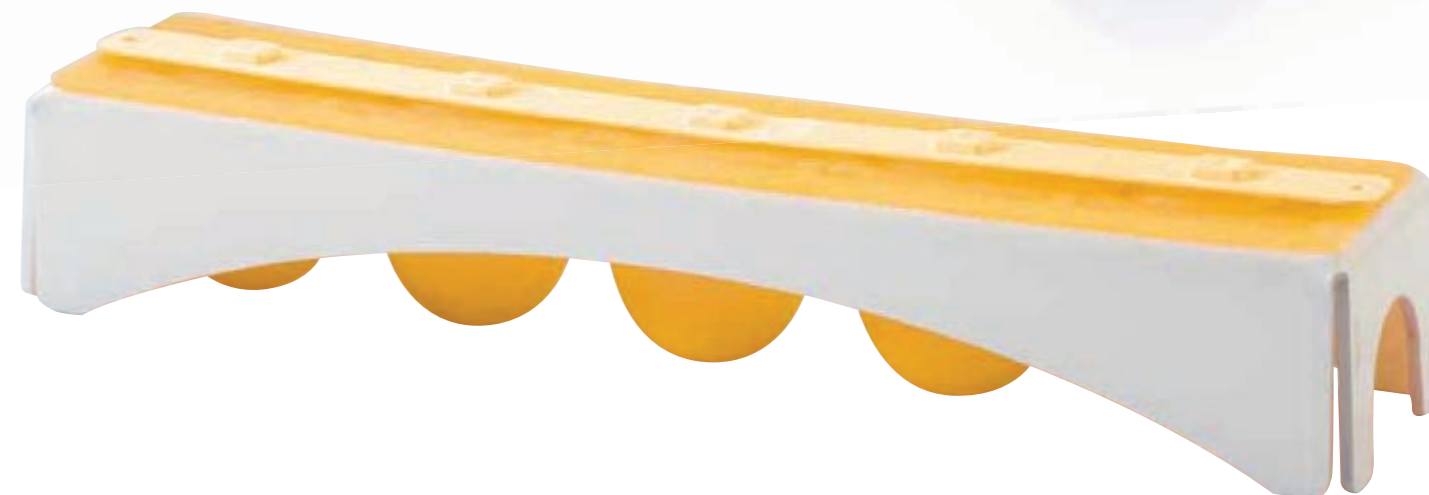

**Ice dessert**  
**103000**

Stampo - Mould: 390x83 h67mm  
Dessert: 60x36 h66mm  
Prod: 5 pcs - 80 gr approx

## PLEXIGLASS DISPLAYS



**10-E001**

Espositore per stecchi gelato  
Display for Ice creams stiks  
Misura - Size: 380x235 h40mm  
Cap. 24 pcs





# push UP pops®

L'equilibrato mix di caratteristiche che rendono questo prodotto unico nel suo genere sono: funzionalità, praticità, eleganza e versatilità.

Lo stampo, dopo la produzione, diventa un sistema di esposizione in vetrina o negli eleganti banchetti. Ideale per la realizzazione di dolci semifreddi o stuzzicanti aperitivi.

The balanced mix of features that make this product unique are: functionality, practicality, elegance and versatility.

After production, the mould becomes a display system in the showcase or in elegant banquets. Ideal for making semifreddo desserts or tasty appetizers.

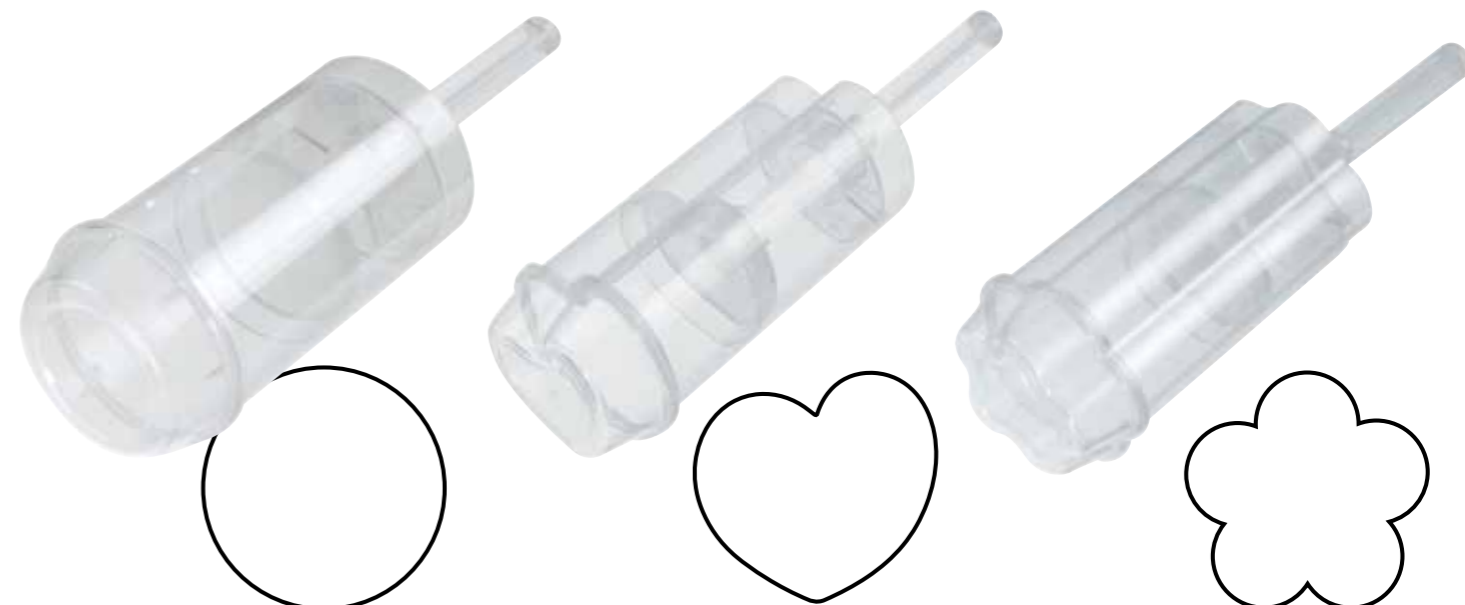

**TONDI - ROUNDS**  
**GST01**  
 100 pcs  
 Ø40 h 188mm ~ 90ml

**CUORI - HEARTS**  
**GST02**  
 100 pcs  
 Ø45 h 187mm ~ 90ml

**FIORI - FLOWERS**  
**GST03**  
 100 pcs  
 Ø48 h 188mm ~ 90ml

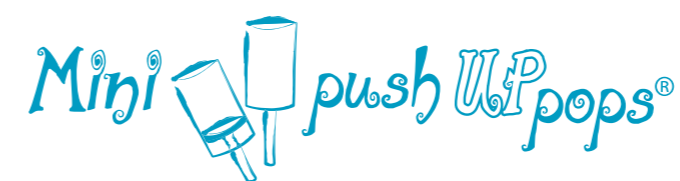
# Mini push UP pops®



**TONDI - ROUNDS**  
**GST10**  
 100 pcs - Ø35 h 196mm ~ 50ml



## PUSH UP POPS DISPLAYS



### GSTESPO44

Ø480 h420 mm - 44 sedi - holes



### GSTESPO24

Ø370 h355 mm - 24 sedi - holes

### GSTESPO36

Ø480 h330 mm - 36 sedi - holes  
Piatto - Plate: Ø 21 cm

Supporto plastica bianca per abbattitore  
White plastic holder for blast chiller

### GSTESPOB

310x400 h90 mm  
28 sedi - holes



Espositore trasparente vetrina verticale  
Transparent display for vertical cabinets

### GSTESPO18

310x250 h 90 mm  
18 sedi - holes



Espositori satinati per vetrina gelato  
Displays for standard ice-cream

### GSTESPO21 GSTESPO15

250x360 h40 mm 160x360 h40 mm  
21 sedi - holes 15 sedi - holes  
occupano lo spazio di vaschette standard  
for standard ice-cream tray size



## ICE CREAM MOULDS



Stampi silicone per gelati su stecco  
Silicone moulds for ice-cream stick

### 104000

2 Stampi - 2 Moulds: 390x146mm  
Ice-cream: 44x22 h93mm  
Prod: 12 pcs

il kit contiene una conf. da 50pz di bastoncini in legno  
the kit contains a conf. from 50pcs of wooden sticks

## MINI PUSH UP POPS DISPLAYS

Supporto plastica bianca per abbattitore  
White plastic holder for blast chiller

### GSTESPOBM40

310x400 h90 mm  
40 sedi - holes

Espositore trasparente vetrina verticale  
Transparent display for vertical cabinets

### GSTESPOM30

310x250 h 90 mm  
30 sedi - holes

Espositori satinati per vetrina gelato  
Displays for standard ice-cream

### GSTESPOM35 GSTESPOM21

360x250 h40 mm 360x160 h40 mm  
35 sedi - holes 21 sedi - holes  
occupano lo spazio di vaschette standard  
for standard ice-cream tray size



# CookiePro

linea professionale stampi gelato

La linea di stampi per gelato biscotto sono un esempio di funzionalità, qualità e praticità per rispondere alle esigenze dei professionisti del settore. L'abbinamento teglia di sostegno in plastica rigida e vassoi removibili con foro per l'estrazione, semplificano notevolmente la produzione e lo stoccaggio dei gelati.

The line of moulds for ice-cream biscuits are an example of functionality, quality and practicality to meet the needs of ice-cream professionals. The combination between the pan support and the hard plastic removable trays, with holes for extraction, greatly simplifies the production and storage of ice cream.



**Stampi per biscotti rotondi**  
Round cookies moulds

Produttività	Size	Code
18 pcs	Ø78 mm	10-0078
15 pcs	Ø83 mm	10-0083

**Stampi per biscotti rettangolari**  
Rectangular cookies moulds

Produttività	Size	Code
18 pcs	48x87,5 mm	10-4887
18 pcs	61x91 mm	10-6191
24 pcs	48,7x70,2 mm	10-4770
18 pcs	67x98 mm	10-6798



## PLEXIGLASS DISPLAYS



**per vetrina orizzontale**  
for horizontal showcases

Cap.	Size mm	Code	per-for
8 pcs	165x360 h 27	10-EV008	10-0083
12 pcs	245x360 h 27	10-EV012	10-0083
10 pcs	165x360 h 27	10-EV010	10-0078
15 pcs	245x360 h 27	10-EV015	10-0078

**per vetrina verticale**  
for vertical cabinets

Cap.	Size mm	Code	per-for
15 pcs	260x330 h 65	10-E015	10-0083

**per vetrina orizzontale**  
for horizontal showcases

Size mm	Code	per-for
380x235 h 40	10-E001	rectangular





# SEGNAGUSTO FLAVOUR MARKER



## IMMERSIONE - IMMERSION

2 forme, infiniti gusti: ordina il tuo preferito  
Segnagusti in plexiglass color bianco opale, con stampa monofacciale colorata.  
Oltre ai 96 gusti disponibili, su richiesta sarà **possibile la personalizzazione** della grafica con diversi gusti e loghi.

2 shapes, infinite flavour: Order your favorite  
Plexiglass flavor cards , opal white with colored single-sided printing.  
In addition to the 96 available flavors, on request will be **possible to customize** the graphics with different tastes and logos.

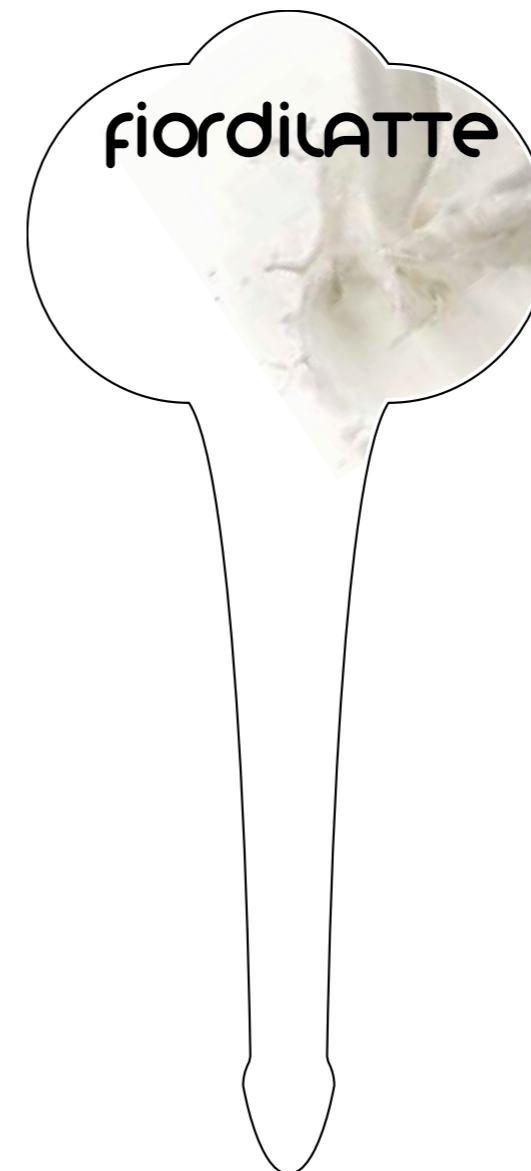

Segnagusto grandi in plexiglass  
Big plexiglass ice-cream flavour

Mod. **10SEG10--\***  
LINGUA ITALIANA  
Misure - Size: 190x85mm

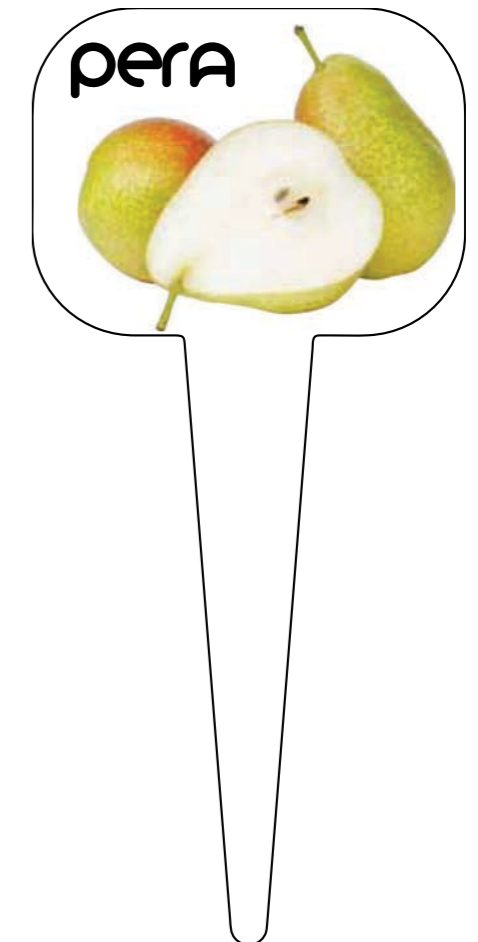

Segnagusto piccoli in plexiglass  
Small plexiglass ice-cream flavour

Mod. **10SEG051---\***  
LINGUA ITALIANA  
Misure - Size: 150x70mm

\*Per ordinarli: codice 10SEG1010 + numero gusto corrispondente vedi pg 217,  
(esempio: 10SEG101037 fior di latte)



# APPOGGIO - FREE-STANDING



**Porta cartellino in plexiglass**  
**Transparent plexiglass label holder**

**10SEGB**

Misure - Size: 87x52mm  
per segnagusto mod. 10B1 - Cartellini non inclusi  
for flavour marker mod. 10B1 - Labels not included.  
**Pack 10 pcs**



**Cartellino in plastica segnagusto**  
**Plastic label for flavour marker holder**

Mod. **10B10--\***

Misure - Size: 87x50mm  
Porta cartellino in plexiglass non incluso.  
Transparent plexiglass label holder not included.

\*Per ordinarli: codice 10B10 + numero gusto corrispondente vedi pg 217, (esempio: 10B1017 cappuccino)

**Segnagusto da appoggio**  
**Countertop flavour marker**

Mod. **10SEGC10--\***

Misure - Size: 87x52mm  
Supporto in plexiglass, color bianco opale, stampa ambedue i lati.  
Opal white plexiglass holder, two-sided print.



\*Per ordinarli: codice 10B10 + numero gusto corrispondente vedi pg 217, (esempio: 10SEGC1033 crema catalana)

# CODICI GUSTO - FLAVOUR CODE

ACE 1	AFTER EIGHT 2	ALBICOCCA 3	AMARENA 4	AMARETTO 5	ANANAS 6
ANGURIA 7	ANICE 8	ARANCIA 9	BABA' 10	BACIO 11	BACIO BIANCO 12
BANANA 13	BISCOTTO 14	CAFFE' 15	CANNELLA 16	CAPPUCCINO 17	CARAMELLO 18
CASSATA 19	cedro 20	cereali 21	CHEESE CAKE 22	cioccolata 23	CIOCcolato AL LATTE 24
CIOCcolato AL PEPPERONCINO 25	CIOCcolato AL' ARANCIA 26	CIOCcolato BIANCO 27	CIOCcolato FONDENTE 28	COCCO 29	CRÈME CARAMEL 30
CREMA 31	CREMA AL WHISKY 32	CREMA CATALANA 33	CREMA NOCCIOLA 34	CREMINO 35	fico 36
fiordilatte 37	FRAGOLA 38	FRUTTI DI BOSCO 39	FRUTTO DELLA PASSIONE 40	GELSO NERO 41	GIANDUIOTTO 42
Kiwi 43	LAMPONE 44	LATTE e MOU 45	LIMONCELLO 46	LIMONE 47	LIQUIRIZIA 48
MACEDONIA 49	MALAGA 50	MANDARINO 51	MANDORLA 52	MANGO 53	MARRON GLACÉ 54
MASCARPONE 55	MELA VERDE 56	MELONE 57	MENTA 58	MENTA BIANCA 59	MERINGA 60
Miele 61	Mille foglie 62	MIRTILLO 63	MORA 64	NOCCIOLA 65	NOCE 66
PANNA COTTA 67	PAPAYA 68	PERA 69	PESCA 70	PINOLO 71	pistacchio 72
pompelmo 73	PRUGNA 74	ribes 75	ricotta e fichi 76	riso soffiato 77	rocher 78
soia 79	SPAGNOLA 80	STRACCIATELLA 81	TARTUFO 82	Te' verde 83	TIRAMISU' 84
TORRONE 85	UVA 86	UVA FRAGOLA 87	VANIGLIA 88	VARIEGATO AL CAFFE' 89	VARIEGATO AMARENA 90
VARIEGATO FRUTTI DI BOSCO 91	YOGURT 92	YOGURT VARIEGATO 93	ZABAIONE 94	ZENZERO 95	ZUPPA INGLESE 96

Contattateci per ulteriori gusti, anche su richiesta.  
Please contact us for different flavour also in your language.



# IMMERSIONE - IMMERSION

Supporto ad immersione in plexiglass accoppiato per contenere e proteggere.  
Il cartellino con gusto (non incluso) può essere scelto tra quelli disponibili o personalizzato.

Plexiglass immersion support made up of two parts that must be matched in order to hold and therefore protect.  
Add the ice-cream flavour card (not included) or ask for your customization.



Supporti in plexiglass per segnagusto  
Plexiglass supports for ice-cream flavour

**10SEG**

Cartellini non inclusi - Labels not included.  
Kit 10 pcs - h 19 cm



kit 30 pcs  
**10SEG01** - LINGUA ITALIANA  
Kit cartellini segnagusto FRUTTA  
composto da 30 gusti diversi (supporti in plastica non inclusi)

kit 30 pcs  
**10SEG01EN** - ENGLISH LANGUAGE  
Fruit flavour label kit made up of 30 different flavours  
(plastic holders not included)



kit 30 pcs  
**10SEG02** - LINGUA ITALIANA  
Kit cartellini segnagusto CREME  
composto da 30 gusti diversi (supporti in plastica non inclusi)

kit 30 pcs  
**10SEG02EN** - ENGLISH LANGUAGE  
Fruit flavour label kit made up of 30 different flavours  
(plastic holders not included)



kit 30 pcs  
**10SEG03** - LINGUA ITALIANA  
Kit cartellini segnagusto FRUTTA  
composto da 30 gusti diversi (supporti in plastica non inclusi)



kit 30 pcs  
**10SEG04** - LINGUA ITALIANA  
Kit cartellini segnagusto CREME  
composto da 30 gusti diversi (supporti in plastica non inclusi)



# SPATOLE GELATO ICE CREAM SPATULAS



## CLASSIC

**10SG00**  
Trasparente - Transparent

Lunghezza totale/ Total length: 26cm  
Manico/ Handle: 13cm



**10SG01** Bianco - White  
**10SG02** Lilla - Lilac  
**10SG03** Rosa - Pink  
**10SG04** Azzurro - Sky Blue  
**10SG05** Verde - Green  
**10SG06** Giallo - Yellow  
**10SG100** Finto legno - Wood-like

## CARAPINA

**10SGC00**  
Trasparente - Transparent

Lunghezza totale/ Total length: 20cm  
Manico/ Handle: 10cm



**10SGC01** Bianco - White  
**10SGC02** Lilla - Lilac  
**10SGC03** Rosa - Pink  
**10SGC04** Azzurro - Sky Blue  
**10SGC05** Verde - Green  
**10SGC06** Giallo - Yellow  
**10SGC100** Finto legno - Wood-like

## FLUO

**SGM00**  
Trasparente - Transparent

Lunghezza totale/ Total length: 27cm  
Manico/ Handle: 14cm



**SGM001** Arancio - Orange  
**SGM002** Blu - Blue  
**SGM003** Bianco - White  
**SGM004** Giallo - Yellow  
**SGM007** Rosa - Pink  
**SGM008** Rosso - Red  
**SGM009** Verde - Green  
**SGM100** Finto legno - Wood-like



## PORZIONATORI - ICE CREAM SCOOP

Porzionatore a molla in acciaio inox, impugnatura in plastica isolante.  
Ice cream scoop with clip, stainless steel, handgrip in plastic insulated

NEW

Size mm		Code
Ø 38	1/65	10PG01
Ø 44	1/40	10PG02
Ø 48	1/30	10PG03
Ø 50	1/24	10PG04
Ø 57	1/20	10PG05



## CUCCHIAI - SPOON

NEW

Cap. gr	Code
30	10CG01
42	10CG02
60	10CG03
70	10CG04



## PLEXIGLASS DISPLAY



Portaconi piccoli  
AG09002  
Cap. 27 pcs

Portaconi piccoli  
AG09003  
Cap. 45 pcs

## VASCLETTE - ICE CREAM BASIN

Vaschetta riutilizzabile in plastica per vetrina gelato  
Reusable ice cream basin for ice-cream horizontal showcases



NEW  
Bianco - White  
AG36258POLB  
25x36 - h8 cm - 3,6 L

NEW  
Nero - Black  
AG36258POLN  
25x36 - h8 cm - 3,6 L

NEW  
Bianco - White  
AG362512POLB  
25x36 - h12 cm - 5,8 L

NEW  
Nero - Black  
AG362512POLN  
25x36 - h12 cm - 5,8 L

Vaschetta monouso in plastica per vetrina gelato  
Disposable ice cream basin for ice-cream horizontal showcases



Vaschetta usa e getta (PST)  
Disposable ice cream basin (PST)  
25x36 h8 cm - Pack 80 pcs  
AG36025080MNG1 - 70 gr  
AG36025080MNG2 - 90 gr

Vaschetta usa e getta (PST)  
Disposable ice cream basin (PST)  
16,5x36 h12,5 cm - Pack 63 pcs  
AG360165120MNG1 - 70 gr  
AG360165120MNG2 - 90 gr

## RASCHIETTI - SCRAPERS



RTRA1



RTRA2



RTRA3



RTRA4



RTRA5

RTRA1-5  
Set 5 raschietti decorativi misti  
Set composed of 5 different decorative scrapers  
Misura - Size 14,5x15cm







## ATTREZZATURE EQUIPMENT

SAC A POCHE/PASTRY BAGS	226
BOCCHETTE/PIPING TIPS	230
SPATOLE/SPATULAS	242
COLTELLI/KNIVES	245
STRUMENTI/TOOLS	246
ZUCCHERO/SUGAR	284
PLEXIGLASS DISPLAYS	286
CONTENITORI/CONTAINERS	290



# SAC A POCHE MONOUSO DISPOSABLE PASTRY BAGS

Pratici sacchetti monouso in plastica alimentare che facilitano il lavoro di pasticceri e cuochi annullando i tempi del lavaggio di uno dei più utilizzati attrezzi. Realizzati completamente in Italia, i tre modelli hanno diverse caratteristiche per rispondere alle molteplici esigenze dei professionisti.

La nuova saldatura, molto più sottile, riduce i profili e consente una maggiore praticità e maneggevolezza, senza penalizzare la resistenza e conferendo al prodotto maggior qualità.

Practical food-grade plastic disposable bags that make a confectioner's or chef's job easier, with no more washing required for one of the most used tools. Made wholly in Italy, the three models have different characteristics to meet the professionals' many requirements. The new, much thinner seal reduces profiles and allows greater practicality and handling, without affecting resistance and giving the product improved quality.



## Roll

Sac a poche monouso in polietilene trasparente, spessore **90 Micron**. Disposable pastry bags made of transparent polyethylene, **90 Microns thick**.

Size cm	pcs box	Code
30	100	<b>ROLL H 30</b>
40	100	<b>ROLL H 40</b>
55	100	<b>ROLL H 55</b>
65	100	<b>ROLL H 65</b>



## Green Poche



Sac a poche monouso in polietilene verde, spessore **80 Micron**. Disposable pastry bags made of green polyethylene, **80 Microns thick**.

Size cm	pcs box	Code
30	100	<b>50-1030</b>
40	100	<b>50-1040</b>
55	100	<b>50-1055</b>
65	100	<b>50-1065</b>



L'effetto grip del polietilene facilita notevolmente la presa del sacchetto agevolando il lavoro del pasticciere. The "grip effect" of polyethylene greatly facilitates pastry chefs' work.

## Orange Poche



Sac a poche monouso in polietilene arancione, spessore **70 Micron**. Disposable pastry bags made of orange polyethylene, **70 Microns thick**.

Size cm	pcs box	Code
30	100	<b>50-0030</b>
40	100	<b>50-0040</b>
55	100	<b>50-0055</b>
65	100	<b>50-0065</b>





## COTTON

Prodotti con fibre di **cotone** rivestite di poliuretano.  
 Provvisti di asola e **punta rinforzata**.  
 Made of polyurethane coated **cotton** fibers.  
 Turned and sewed rimes, **reinforced tip**.



Size cm	Code
25	<b>STD 025 CM</b>
28	<b>STD 028 CM</b>
34	<b>STD 034 CM</b>
40	<b>STD 040 CM</b>
46	<b>STD 046 CM</b>
50	<b>STD 050 CM</b>
55	<b>STD 055 CM</b>
60	<b>STD 060 CM</b>
65	<b>STD 065 CM</b>
70	<b>STD 070 CM</b>
75	<b>STD 075 CM</b>

## FLEX

Prodotti con fibre di **poliestere** rivestite di poliuretano.  
 Provvisti di asola.  
 Made of polyurethane coated **polyester** fibers.  
 With welded seam.



Size cm	Code
25	<b>FLEX 025 CM</b>
28	<b>FLEX 028 CM</b>
34	<b>FLEX 034 CM</b>
40	<b>FLEX 040 CM</b>
46	<b>FLEX 046 CM</b>
50	<b>FLEX 050 CM</b>
55	<b>FLEX 055 CM</b>
60	<b>FLEX 060 CM</b>
65	<b>FLEX 065 CM</b>
70	<b>FLEX 070 CM</b>

**Vaso porta sac a poche**  
**Pastry bag holder**  
**50VA001A**  
 Ø200 - h240 mm



## SUPERFLEX

Realizzato con un innovativo materiale alimentare che conferisce al prodotto un'elevata resistenza, flessibilità e morbidezza. Il nuovo Superflex presenta una superficie liscia all'interno che facilita la fuoriuscita del prodotto, e ruvida all'esterno per un'impugnatura più salda. Grazie allo speciale e innovativo sistema di saldatura del sacchetto la sicurezza igienica è maggiormente garantita.

An innovative food-safe material than gives high resistance, flexibility and softness to pastry bags. Superflex bags have a smooth internal surface for an easy emission of creams and an external rough surface for a better grip. Thanks to a special welding of the bag we can guarantee a high hygienic safety.



### Senza Imballo Unpacked

Size cm	Code
34	<b>SPR034</b>
45	<b>SPR045</b>
50	<b>SPR050</b>

### Con Imballo With package

Size cm	Code
34	<b>SPR034/C</b>
45	<b>SPR045/C</b>
50	<b>SPR050/C</b>



## PRECUT

Sac a poche monouso pretagliati per alimenti in polietilene trasparente, **spessore 90 Micron**.

Disposable precut pastry bags for food made of transparent polyethylene, **90 Microns thick**.

Disponibili confezioni da 25, 50 e 100pz  
 in nylon trasparente.

Packed in transparent nylon 25, 50, 100 pcs

Size cm	pcs box	Code	Size cm	pcs box	Code
30x50	25	<b>SAC 25</b>	17x30	100	<b>SAC 100</b>
30x50	50	<b>SAC 50</b>			



Confezionati in cartone con euroforo.  
 Packed in cardboard boxes with Euro-perforation.

Size cm	pcs box	Code	Size cm	pcs box	Code
23x45	100	<b>SAC45X100</b>	30x58	100	<b>SAC58X100</b>



# BOCCHETTE PIPING TIPS

Acciaio inox 18/10  
Stainless steel 18/10



## STELLA - STAR



### OPEN STAR

Code	Size mm	#	Code	Size mm	#	Code	Size mm	#
BS 102	Ø25 h50	2	BS 108	Ø25 h45	8	BS 114	Ø35 h55	14
BS 103	Ø25 h50	3	BS 109	Ø25 h40	9	BS 115	Ø35 h50	15
BS 104	Ø25 h50	4	BS 110	Ø30 h50	10	BS 116	Ø35 h50	16
BS 105	Ø25 h50	5	BS 111	Ø30 h50	11	BS 117	Ø35 h50	17
BS 106	Ø25 h45	6	BS 112	Ø30 h50	12	BS 118	Ø35 h50	18
BS 107	Ø25 h50	7	BS 113	Ø30 h50	13			



### OPEN STAR

Code	Size mm	#	Code	Size mm	#	Code	Size mm	#
BF 310	Ø25 h45	4	BF 314/11	Ø30 h50	11	BF 0867	Ø35 h50	16
BF 311	Ø25 h45	6	BF 315	Ø30 h45	12	BF 0869	Ø35 h48	20
BF 312	Ø25 h45	7	BF 316	Ø30 h45	13			
BF 313	Ø25 h45	9	BF 317	Ø35 h50	15			
BF 314	Ø30 h50	10	BF 318	Ø35 h50	16			
			BF 319	Ø35 h50	18			



### CLOSED STAR

Code	Size mm	#	Code	Size mm	#	Code	Size mm	#
BC 320	Ø25 h47	2	BC 324	Ø25 h43	6	BC 328	Ø35 h53	10
BC 321	Ø25 h47	3	BC 325	Ø35 h50	7	BC 329	Ø35 h50	11
BC 322	Ø25 h47	4	BC 326	Ø30 h45	8	BC 330	Ø35 h50	12
BC 323	Ø25 h47	5	BC 327	Ø30 h50	9			

## TONDA - ROUND



### TONDA - ROUND

Code	Size mm	#	Code	Size mm	#	Code	Size mm	#
BT 202	Ø25 h50	2	BT 209	Ø25 h45	9	BT 216	Ø35 h50	16
BT 203	Ø25 h50	3	BT 210	Ø30 h50	10	BT 217	Ø35 h50	17
BT 204	Ø25 h45	4	BT 211	Ø30 h50	11	BT 218	Ø35 h50	18
BT 205	Ø25 h45	5	BT 212	Ø30 h47	12	BT 220	Ø35 h47	20
BT 206	Ø25 h45	6	BT 213	Ø30 h47	13	BT 222	Ø35 h47	22
BT 207	Ø25 h45	7	BT 214	Ø30 h47	14	BT 224	Ø35 h43	24
BT 208	Ø25 h45	8	BT 215	Ø35 h50	15			

Dove non espressamente indicato le confezioni si intendono da **5 pezzi** - le misure sono in millimetri  
If not indicated, the package contains **5 pieces** - the measurements are in millimeters



## FANCY PIPING NOZZLES



**BX 1820**  
Ø30 h 42  
Top: Ø5



**BX0001**  
Ø37 h 42  
Top: Ø23



**BX0009**  
Ø37 h 42  
Top: Ø23



**BX 0252**  
Ø30 h 40  
Top: Ø20



**BX 0250**  
Ø30 h 40  
Top: Ø20



**BX0028**  
Ø18 h 37  
Top: Ø 0,4



**BX0029**  
Ø18 h 35  
Top: Ø 0,6



**BX0030**  
Ø18 h 36  
Top: Ø 0,9



**BX0031**  
Ø18 h 34  
Top: Ø4



**BX0032**  
Ø18 h 34  
Top: 4x4



**BX0033**  
Ø18 h 33  
Top: 3x3



**BX0034**  
Ø18 h 33  
Top: 5x5



**BX0038**  
Ø18 h 28  
Top: Ø8



**BX0042**  
Ø18 h 30  
Top: Ø5



**BX0045**  
Ø18 h 31  
Top: Ø7



**BX0046**  
Ø18 h 30  
Top: Ø10



**BX0047**  
Ø18 h 26  
Top: Ø9



**BX0048**  
Ø18 h 30  
Top: Ø2mm



**BX0050**  
Ø18 h 24  
Top: Ø11



**BX0026**  
Ø18 h 36  
Top: 25



**BX0027**  
Ø18 h 36  
Top: 25



**BX0039**  
Ø18 h 32  
Top: Ø5



**BX0043**  
Ø18 h 28  
Top: 10



**BX0040**  
Ø18 h 30  
Top: Ø6



**BX0044**  
Ø18 h 28  
Top: Ø8



**BX0049**  
Ø18 h 30  
Top: Ø7



**BX 8019**  
Ø17 h 28  
Top: 9



**BX 2312**  
Ø25 h 33  
Top: 13x20



**BX 2314**  
Ø25 h 40  
Top: 12



**BX 2315**  
Ø30 h 45  
Top: 14



**BX 1510**  
Ø30 h 45  
Top: 13x25

## BASKET PIPING NOZZLES



**BX 9017**  
Ø30 h 50  
Top: 17



**BX 9022**  
Ø30 h 45  
Top: 20



**BD 300**  
Ø25 h 40  
Top: 16x2



**BD 301**  
Ø30 h 43  
Top: 20x3



**BD 302**  
Ø35 h 45  
Top: 27



**BX 0158**  
Ø25 h 45  
Top: 15x5



**BX 1906**  
Ø35 h 45  
Top: 12x3



**BX 0134**  
Ø25 h 42  
Top: 15x2



**BX 3005**  
Ø35 h 50  
Top: Ø5

## STRIPES & BORDER

Dove non espressamente indicato le confezioni si intendono da **5 pezzi** - le misure sono in millimetri  
If not indicated, the package contains **5 pieces** - the measurements are in millimeters



# FLOWER & PETALS NOZZLES



**BX 2013**  
 Ø25 h 40  
 Top: Ø8



**BX 0190**  
 Ø25 h 43  
 Top: Ø3



**BX 4014**  
 Ø25 h 45  
 Top: Ø5



**BX 5017**  
 Ø30 h 43  
 Top: Ø15



**BX 6018**  
 Ø30 h 45  
 Top: Ø6



**BX 1013**  
 Ø25 h 43  
 Top: 13



**BS 0F6K**  
 Ø30 h 45  
 Top: 18



**BS 0D6K**  
 Ø25 h 42  
 Top: 6



**BX 0108**  
 Ø25 h 40  
 Top: 13



**BX 0510**  
 Ø25 h 42  
 Top: Ø5



**BX 7020**  
 Ø30 h 45  
 Top: Ø10



**BC 0855**  
 Ø30 h 45  
 Top: Ø8



**BR 330**  
 Ø30 h 50  
 Top: Ø5



**BR 331**  
 Ø30 h 45  
 Top: Ø6



**BR 332**  
 Ø35 h 50  
 Top: Ø8



**BA 411**  
 Ø30 h 50  
 Top: Ø11



**BA 413**  
 Ø30 h 47  
 Top: Ø13



**BA 415**  
 Ø35 h 53  
 Top: Ø15



**BX 0116**  
 Ø25 h 40  
 Top: 16x2



**BX 0119**  
 Ø25 h 40  
 Top: 19x2



**BS 0195**  
 Ø25 h 42  
 Top: Ø6



**BX 1303**  
 Ø25 h 40  
 Top: 16



**BS 0195K**  
 Ø25 h 40  
 Top: Ø10



**BX 1217**  
 Ø25 h 37  
 Top: 18x4



**BX 1405**  
 Ø25 h 40  
 Top: 20x7



**BX 0120**  
 Ø24 h 43  
 Top: 13x2



**BX 0123**  
 Ø24 h 40  
 Top: 17

# SAINT HONORÉ



**BX9990**  
 Ø10



**BX9991**  
 Ø12



**BX9992**  
 Ø14

Dove non espressamente indicato le confezioni si intendono da **5 pezzi** - le misure sono in millimetri  
 If not indicated, the package contains **5 pieces** - the measurements are in millimeters



## LEAVES & GRASS



**BX 1105** Ø25 h 40 Top: 17x2  
**BX 1115** Ø25 h 50 Top: 18  
**BX 1123** Ø25 h 40 Top: 16  
**BX 1132** Ø25 h 40 Top: 14  
**BX 1605** Ø25 h 45 Top: 8  
**BX 1713** Size: Ø25 h 40 Top: Ø2



**BX 2117** Ø25 h 40 Top: Ø1  
**BX0012** Ø37 h 42 Top: Ø23  
**BX 2219** Ø30 h 40 Top: Ø2  
**BX0041** Ø18 h 34 Top: 10  
**BX0035** Ø18 h 35 Top: 5x1  
**BX0036** Ø18 h 35 Top: 7x1,5  
**BX0037** Ø18 h 33 Top: 10x3

## SPECIAL NOZZLES



**BXB01** Size: Ø55 h 60 Top: Ø31 pack 1 pc  
**BXB02** Size: Ø55 h 56 Top: Ø31 pack 1 pc

**BIM 340** Ø25 h 90 Top: Ø4

**BIM 232** Ø25 h 95 Top: Ø8

## piping tips *Floreal*



**BX0002** Ø37 h 42  
**BX0004** Ø37 h 42  
**BX0006** Ø37 h 42



**BX0008** Ø37 h 42  
**BX0011** Ø37 h 42  
**BX0014** Ø37 h 42  
**BX0016** Ø37 h 42  
**BX0017** Ø37 h 42  
**BX0023** Ø37 h 42



**BX0051** Ø35 h 38  
**BX0052** Ø35 h 38  
**BX0053** Ø35 h 38  
**BX0054** Ø37 h 42  
**BX0055** Ø37 h 42  
**BX0056** Ø37 h 42



**BX0057** Ø37 h 42  
**BX0058** Ø37 h 42  
**BX0059** Ø37 h 42  
**BX0060** Ø37 h 42  
**BX0061** Ø37 h 42



Dove non espressamente indicato le confezioni si intendono da **5 pezzi** - le misure sono in millimetri  
 If not indicated, the package contains **5 pieces** - the measurements are in millimeters



## SPHERE BALL PIPING NOZZLES



**BX0100**

Size: Ø32 h 60  
Top: Ø22  
pack 1 pc

**BX0101**

Size: Ø32 h 57  
Top: Ø22  
pack 1 pc

**BX0102**

Size: Ø32 h 57  
Top: Ø22  
pack 1 pc

**BX0103**

Size: Ø32 h 57  
Top: Ø22  
pack 1 pc

**BX0104**

Size: Ø32 h 57  
Top: Ø22  
pack 1 pc

## ADAPTERS



**Floreal & Sphere Ball**  
**50AD004**

Per bocchette a sfera e floreali  
For sphere ball and floreal tips  
pack 2 pcs



**Piccolo - Small**  
**50AD001**

base 18  
pack 1 pc



**Medio - Medium**  
**50AD002**

base 25 - 31  
kit 2 pcs



**Grande - Large**  
**50AD003**

base 36  
pack 1 pc



Adatto a bocchette - Suitable for piping tips: Ø30 h 50

**Bi-Tri**  
**& Tri**  
**COLOR**

**40-WA010**

Kit di adattatori,  
per realizzare decorazioni a due o tre colori.  
Adapter kit suitable to prepare  
decorations with two or three colours. pack 2 pcs

## DISPLAYS



**Espositore in plexiglass**  
**Plexiglass display**

**ESPOB60**

Size: 515x315 h210mm  
with crowner for 60 piping tips



**Espositore per bocchette e sac a poche**  
**Wall rack for piping tips and pastry bags**

**ESPO B**

Bianco - White

**ESPO ST**

Inox - Stainless steel



**Portabocchette in plexiglass**  
**Plexiglass piping tips holder**

**ESPOB032**

Size: 310x100 h390mm



# BOXES



**BOS 52**  
Box 52 pcs



**BOS 26**  
Box 26 pcs



**BOS 36 BIG**  
Box 36 pcs



**BOS12FLO**  
Box 12 pcs



**BOS 24**  
Bocchette in policarbonato ideali per decorazioni  
Polycarbonate piping tips ideal for decorations  
Box 24 pcs



**BOS 60**  
Bocchette in policarbonato ideali per decorazioni  
Polycarbonate piping tips ideal for decorations  
Box 60 pcs



Plastica - Plastic  
**BOSPL1**  
Box 12 pcs



Plastica - Plastic  
**BOSPL2**  
Box 12 pcs



Plastica - Plastic  
**BPL6**  
Box 6 pcs



Plastica - Plastic  
**BOSPL3**  
Box 20 pcs



Plastica - Plastic  
**BOSPL4**  
Box 20 pcs



Bruschino - Brush  
**BRU**  
per la pulizia delle bocchette.  
for piping tips cleaning.



Kit 10 mix - lisce  
**BS 10 T**  
Ø 4 - 5 - 6 - 7 - 8 - 9 - 10 - 12 - 13 - 15 mm



Kit 10 mix - stella  
**BS 10 S**  
Ø 4 - 5 - 6 - 7 - 8 - 9 - 10 - 12 - 13 - 15 mm



Policarbonato - Polycarbonate  
**BBP1**  
Box 12 pcs



Policarbonato - Polycarbonate  
**BBP2**  
Box 12 pcs



Policarbonato - Polycarbonate  
**BBP3**  
Box 24 pcs



# SPATOLE PROFESSIONALI PROFESSIONAL SPATULAS



Spatola angolare con lama inox flessibile e manico in plastica.

Angular stainless steel flexible spatula, with plastic handle.

Lama - Blade mm	Manico Handle	Code
20x90	120	<b>50SPANG09</b>
29x160	130	<b>50SPANG16</b>
37x205	130	<b>50SPANG20</b>



Spatola con lama inox flessibile e manico in plastica.

Stainless steel cake spatula with plastic handle.

Lama - Blade mm	Manico Handle	Code
27x155	130	<b>50SPA15</b>
29x200	130	<b>50SPA20</b>
37x254	130	<b>50SPA25</b>
45x308	130	<b>50SPA30</b>



Spatole rigide in plastica (ABS)  
Resistenti a temperature fino 100°C.  
Hard plastic spatulas (ABS)  
Heat resistant up to 100°C.

Size mm	Code
150	<b>50SA150B</b>
250	<b>50SA250B</b>



Spatole morbide in plastica (TPE)  
Resistenti a temperature fino 100°C.  
Soft plastic spatulas (TPE)  
Heat resistant up to 100°C.

Size mm	Code
250	<b>50SG250B</b>
300	<b>50SG300B</b>
350	<b>50SG350B</b>



Spatole rigide in plastica (ABS)  
Resistenti a temperature fino 100°C.  
Hard plastic spatulas (ABS)  
Heat resistant up to 100°C.

Size mm	Code
300	<b>50SL300B</b>
370	<b>50SL370B</b>



Spatole rigide in plastica (ABS)  
Resistenti a temperature fino 100°C.  
Hard plastic spatulas (ABS)  
Heat resistant up to 100°C.

Size mm	Code
300	<b>50SP300B</b>
350	<b>50SP350B</b>
400	<b>50SP400B</b>



Spatole rigide in plastica (ABS)  
Resistenti a temperature fino 100°C.  
Hard plastic spatulas (ABS)  
Heat resistant up to 100°C.

Size mm	Code
300	<b>SCM30</b>
350	<b>SCM35</b>
400	<b>SCM40</b>





# COLTELLERIA - KNIVES

Spatole in gomma con manico in polipropilene.  
Resistenti a temperature fino 70°C.  
Rubber spatulas with polypropylene handle.  
Heat resistant up to 70°C.

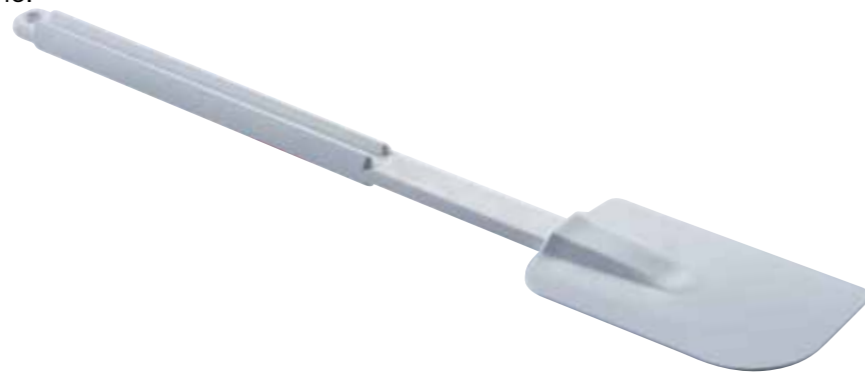

Size mm	Code
275	<b>50GO275</b>
300	<b>50GO300</b>
350	<b>50GO350</b>
400	<b>50GO400</b>

Spatole in gomma con manico in plastica.  
Resistenti a temperature fino 100°C.  
Rubber spatulas with plastic handle.  
Heat resistant up to 100°C.



Size mm	Code
250	<b>MEL250</b>
350	<b>MEL350</b>
450	<b>MEL450</b>

Spatole in gomma a cucchiaio con manico in plastica.  
Resistenti a temperature fino 110°C.  
Rubber spoon spatulas with plastic handle.  
Heat resistant up to 110°C.



Size mm	Code
250	<b>MSP250</b>
350	<b>MSP350</b>

Spatole in Polyglass.  
Resistente fino a 220°C.  
Polyglass spatulas.  
Heat resistant up to 220°C.



Size mm	Code
250mm	<b>MEX250</b>
300mm	<b>MEX300</b>
400mm	<b>MEX400</b>
500mm	<b>MEX500</b>

Spatola rettangolare in plastica (ABS)  
Resistenti a temperature fino 100°C.  
Rectangular plastic spatula (ABS)  
Heat resistant up to 100°C.



**NEW**

Size mm	Code
340mm	<b>50SR340</b>

Lama in acciaio inox temperato  
Manico in plastica antiscivolo  
Confezione blister

Tempered st. steel blade  
Anti-slip nylon handle  
Blister packaging

**MADE IN ITALY**



**Cuoco 26 - Chef 26**  
**50COL04**  
Lama - Blade: 260mm



**Pasticceria 30 - Pastry 30**  
**50COL02**  
Lama - Blade: 300mm



**Cuoco 30 - Chef 30**  
**50COL05**  
Lama - Blade: 300mm



**Pasticceria 36 - Pastry 36**  
**50COL03**  
Lama - Blade: 360mm



**Spelucchino 9 - Paring 9**  
**50COL01**  
Lama - Blade: 90mm



**Salati e formaggi 26 - Salty and cheese 26**  
**50COL06**  
Lama - Blade: 260mm



**Pane e panettone 25 - Bread and panettone 25**  
**50COL07**  
Lama - Blade: 250mm



# STRUMENTI PROFESSIONALI PROFESSIONAL TOOLS



## CHEF WHIP

### Sifone per panna

Adatto per una preparazione veloce di panna montata, spugne mousse, dolci, schiume fredde e salse. Ideale per guarnire cappuccini, caffè, dolci e gelati adatto anche alla preparazione di salse calde. Per il funzionamento utilizzare solo capsule di azoto (N2O). Capsule non incluse.

### Cream Whipper

Makes delicious whipped cream, mousses, desserts, sponges cold foams, and sauces easily. Perfect for garnishing cappuccinos, coffees, shakes and ice cream. Suitable for dispensing hot creams and sauces. Requires cream charger (N2O) to operate, not included.



NEW

500 ml  
Sifone per panna  
Cream Whipper  
**50SI01**

NEW

1000 ml  
Sifone per panna  
Cream Whipper  
**50SI02**

## BILANCE - SCALES

Pannello touch - Touch panel switch  
Funzione Tara - Tare function

Indicazione di sovraccarico - bassa potenza - Over-load - Low power indication



NEW

**Bilancia piccola - Small scale**  
**50BI01**

Superficie in vetro temperato  
Tempered safety glass platform  
batteries: AAA da 4x 1.5V included

Div 1g - 0,05oz /1ml (1/8cup) - max 5 Kg



NEW

**Bilancia grande - Big scale**  
**50BI02**

Superficie in acciaio inossidabile  
Large weighting stainless steel platform  
batteries: AA da 4x 1.5V included

Div 1g - 0,05oz - max 15 Kg



## PROFESSIONAL PISTON FUNNEL

**Colino professionale** in acciaio inox ideale per dosare la giusta quantità di prodotto nei bicchierini o negli appositi stampi, in modo **facile e senza sprechi**.

Ottimo per salse, gelatine, crème brulée e marmellate liquide, è fornito di un set di bocchette per una migliore applicazione.

**Pratico e confortevole** grazie alla **doppia impugnatura dal design moderno**, si contraddistingue per la **resistenza**, la **stabilità** e la facilità di lavaggio.

La confezione comprende un piedistallo in metallo e tre bocchette da  $\varnothing 2$ ,  $\varnothing 4$  e  $\varnothing 5$  mm.

**Professional stainless steel pastry funnel** ideal to quickly pour the right quantity of product into small glasses or suitable moulds with no waste.

Perfect for sauces, jelly, crème brulée and liquid jams, the sauce gun with stand comes with a nozzle set to pour the liquid properly.

**Handy and comfortable** thanks to the **double handle of modern design style**, the confectionery funnel is **resistant** and **stable**.

Packaging includes a metal support and three nozzles:  $\varnothing 2$ ,  $\varnothing 4$  e  $\varnothing 5$  mm.



### 50C0001

Colino professionale completo.  
Complete and professional funnel.  
cap. 800 ml

## RICAMBI - SPARE PARTS

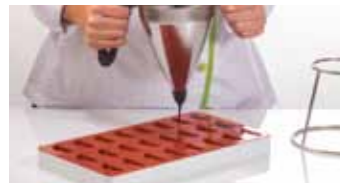

**Asta dosatrice**  
Steel pole  
**50CORIC4**



**Manico plastica**  
Plastic handle  
**50CORIC3**



**Mandrino per bocchetta**  
Nozzle adapter  
**50CORIC7**

**Supporto inox**  
Metal support  
**50CORIC6**

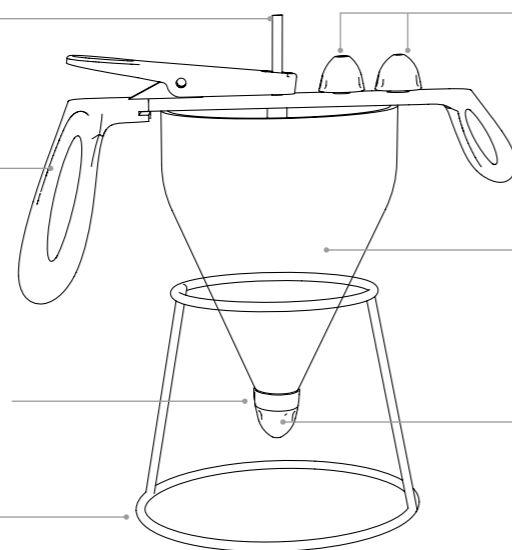

**Bocchetta**  
Nozzle  $\varnothing 4$  mm  
**50CORIC1**

**Bocchetta**  
Nozzle  $\varnothing 2$  mm  
**50CORIC2**

**Imbuto - Funnel**  
**50CORIC5**

**Bocchetta**  
Nozzle  $\varnothing 5$  mm  
**50CORIC0**

## EASY COVER

Vassoi e coperchi in materiale plastico antiurto per lo stoccaggio dei prodotti in frigorifero, congelatore ed abbattitore.

Trays and covers made of strong plastic material, ideal for storage the products in refrigerators, freezers and blast chillers.



**Coperchi e vassoi**  
Lids and trays

60X40 CM

Size cm	Code
59,5x39,5 h 4,2	<b>VC60X404</b>
59,5x39,5 h 6,2	<b>VC60X40</b>
59,5x39,5 h 8,2	<b>VC60X408</b>

30X40 CM

Size cm	Code
30x40 h 6,2	<b>VC30X40</b>

## COPERCHI - LIDS



60X40 CM

Size cm	Code
59x39 h 4	<b>COVER 3H4</b>
59x39 h 6	<b>COVER 3</b>
59x39 h 8	<b>COVER 8</b>

30X40 CM

Size cm	Code
30x40 h 6	<b>COVER 4</b>

## VASSOI - TRAYS



60X40 CM

Size cm	Code
59,8x39,7 h 2	<b>VASSOIOCMO</b>
59x39,7 h 2,5	<b>VASSOIOCFMI</b>

30X40 CM

Size cm	Code
29,7x39,6 h 2	<b>VASSOIOBMI</b>

**Altre misure**  
Other size

Size cm	Code
17,6x39,7 h 1,9	<b>VASSOIOAMO</b>
20,1x39,6 h 1,8	<b>VASSOIOAMI</b>
25,9x39,6 h 2	<b>VASSOIOBMO</b>



## FRUSTE - WHISK



Total size	Code
25 cm	<b>MFRU25</b>
30 cm	<b>MFRU30</b>
35 cm	<b>MFRU35</b>
40 cm	<b>MFRU40</b>
45 cm	<b>MFRU45</b>
50 cm	<b>MFRU50</b>

Frusta acciaio inox con manico ergonomico e pratico in materiale plastico (exoglass). Lavabile fino a 220°C.  
Stainless steel whisk with ergonomic handle (exoglas), heat resistant up to 220°C.



Total size	Code
25 cm	<b>TFRU25</b>
30 cm	<b>TFRU30</b>
35 cm	<b>TFRU35</b>
40 cm	<b>TFRU40</b>
45 cm	<b>TFRU45</b>
50 cm	<b>TFRU50</b>

Frusta acciaio con manico in plastica provvista di gancio per appenderla.  
Steel whisk with plastic handle and hook to be hanged.



Total size	Code
25 cm	<b>50FA01</b>
30 cm	<b>50FA02</b>
35 cm	<b>50FA03</b>
40 cm	<b>50FA04</b>
45 cm	<b>50FA05</b>
50 cm	<b>50FA06</b>

Frusta acciaio inox 8 fili  
Stainless steel whisk 8 wire

## GRATER & ZESTER

Ideale per cioccolato, formaggio, agrumi e altro  
Ideal for chocolate, chees, citrus and more

Custodia protettiva  
Blade cover for save storage

Lama in acciaio  
Stainless steel blade

Manico soft touch antiscivolo  
Non slip soft handle

**NEW** Giallo  
Yellow  
**50ZES01**



**NEW** Rosso  
Red  
**50ZES02**



**NEW** Nero  
Black  
**50ZES03**



## SETACCI - SIEVES

Setacci in acciaio inox per farina.  
Trama setaccio 0,50 mm  
Stainless steel sieves for flour.

Size mm	Code
Ø160	<b>SETAC16</b>
Ø190	<b>SETAC19</b>
Ø210	<b>SETAC21</b>
Ø240	<b>SETAC24</b>
Ø260	<b>SETAC26</b>
Ø280	<b>SETAC28</b>
Ø300	<b>SETAC30</b>



## GRIGLIE - RACKS

Griglie di collaggio in acciaio inox  
Draining racks, stainless steel



Misura - Size	Code
Ø 30 cm	<b>PR30</b>
Ø 40 cm	<b>PR40</b>

Misura - Size	Code
30x30 cm	<b>PR30X30</b>
40x60 cm	<b>PR40X60</b>
50x50 cm	<b>PR50X50</b>



## TAPPETI - MATS

Tappeti antiaderenti in silicone per cottura e surgelazione di qualsiasi prodotto alimentare.  
Non-stick silicon mats for baking and freezing every kind of food.

Codice - Code	Misura - Size
<b>SILICOPAT1/R</b>	395x595mm
<b>SILICOPAT2/R</b>	310x510mm
<b>SILICOPAT5/R</b>	270x420mm
<b>SILICOPAT6/R</b>	360x430mm
<b>SILICOPAT7/R</b>	300x400mm



Tappeti antiaderenti in silicone con fibra di vetro per cottura e surgelazione di qualsiasi prodotto alimentare. **Ideali per la lavorazione dello zucchero.**  
Non-stick silicon mats with glass fibres for baking and freezing every kind of food.  
**Ideal to work with sugar.**

Codice - Code	Misura - Size
<b>SILICOPAT 1/B</b>	595x395mm
<b>SILICOPAT 2/B</b>	310x510mm
<b>SILICOPAT 3/B</b>	620x420mm
<b>SILICOPAT 4/B</b>	790x590mm



Tappetino antiaderente in teflon.  
Non stick teflon mat.

Codice - Code	Misura - Size
<b>TEFLONPAT</b>	60x40 cm



Silicone mat perforated  
Tappeto silicone microforato

Codice - Code	Misura - Size
<b>SILICOPAT11</b>	60x40 cm

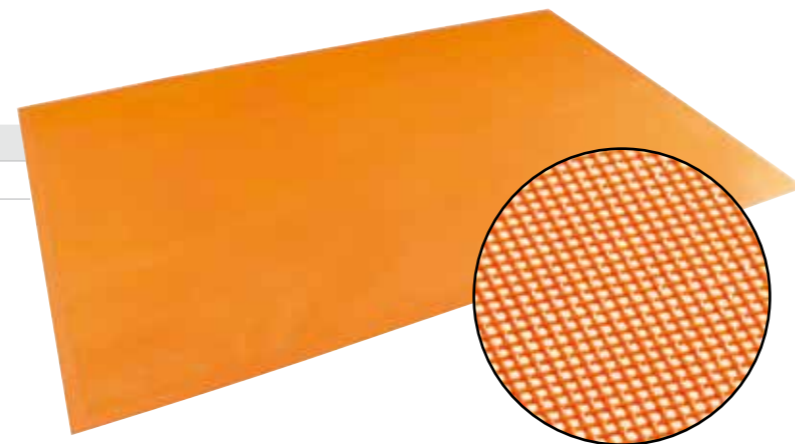

## TEGLIE FORNO - BAKING TRAY

Teglia lamiera alluminata  
con **quattro bordi** spessore 0,8  
Baking tray made of aluminized sheet  
with **four edges** 0,8 thick

Codice - Code	Misura - Size
<b>53TL60404</b>	60x40 h2 cm



Teglia lamiera alluminata  
con **due bordi** spessore 0,8  
Baking tray made of aluminized sheet  
with **two edges** 0,8 thick

Codice - Code	Misura - Size
<b>53TL60402</b>	60x40 h2 cm



Teglia in alluminio  
con **quattro bordi** spessore 1,5  
Aluminium baking tray  
with **four edges** 1,5 thick

Codice - Code	Misura - Size
<b>53TA60404</b>	60x40 h2 cm



Teglia in alluminio  
con **due bordi** spessore 1,5  
Aluminium baking tray  
with **two edges** 1,5 thick

Codice - Code	Misura - Size
<b>53TA60402</b>	60x40 h2 cm



Teglia in alluminio forata  
con **quattro bordi** spessore 1,5  
Flat perforated aluminium baking tray  
with **four edges** 1,5 thick

Codice - Code	Misura - Size
<b>53TAF60404</b>	60x40 cm



Servizio teflonatura su richiesta  
On demand tefloning service

**Carta forno** professionale resistente ai grassi e all'umidità.  
Professional **baking paper**, greaseproof and humidity resistant.

Codice - Code	Misura - Size	Quantità - Quantity
<b>51CF6040</b>	60x40 cm	500 pcs





## RULLI - ROLLING PINS



**Rulli di legno**  
Wooden rolling pins

Size cm *	Code	Size cm *	Code
Ø7 x60	<b>RL 3</b>	Ø7 x50	<b>RL 1</b>
Ø8 x60	<b>RL 4</b>	Ø8 x50	<b>RL 2</b>



**Rulli di legno girevoli**  
Revolving wooden rolling pins

Size cm *	Code	Size cm *	Code
Ø8 x30	<b>RLS 30</b>	Ø8 x45	<b>RLS 45</b>
Ø8 x35	<b>RLS 35</b>	Ø8 x50	<b>RLS 50</b>
Ø8 x40	<b>RLS 40</b>	Ø8 x60	<b>RLS 60</b>



**Rulli in polietilene**  
Polyethylene rolling pins

Size cm *	Code	Size cm *	Code
Ø7 x30	<b>RLS 50 PE</b>	Ø7 x50	<b>RLS 70 PE</b>
Ø7 x40	<b>RLS 60 PE</b>		



**Rulli in polietilene ideali per pasta zucchero**  
Polyethylene rolling pins for sugar paste

Size cm *	Code	Size cm *	Code
Ø4,5 x50	<b>40-W022</b>	Ø2,5 x23	<b>40-W021</b>
Ø4,5 x35	<b>40-W154</b>		

## RULLI FORAPASTA - CUTTING DOCKER



**Rullo in plastica forapasta**  
Plastic spiked roller

Size cm	Code
12	<b>RFP12</b>
6	<b>RFP6</b>



**Rullo in plastica per losanghe**  
Plastic lattice cutting rollers

Size cm	Code
12	<b>RPL12</b>
6	<b>RPL6</b>

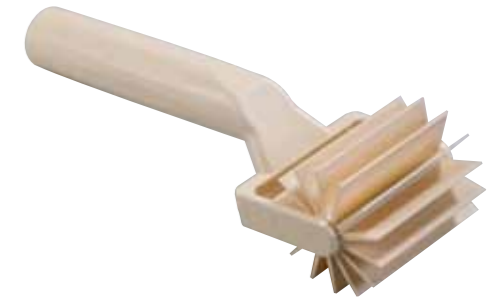

**Rullo in plastica per strudel**  
Plastic cutting roller

Size cm	Code
6	<b>RPS6</b>



**Rullo inox forapasta**  
St. Steel spiked roller

Size cm	Code
12	<b>RFP12INOX</b>



**Rullo inox per losanghe - 7mm**  
Lattice cutting roller - 7mm

Size cm	Code
12	<b>RPL12INOX</b>



**Rullo per grissini in polietilene.**  
Bread stick rolling pin made of polyethylene.

Size cm *	Taglio - cut	Code
Ø10 x19,5	10 mm	<b>SCA 10</b>
19,5	5 mm	<b>RLT 5</b>
19,5	10 mm	<b>RLT 10</b>
19,5	15 mm	<b>RLT 15</b>



**Tagliapizza**  
Pastry cutters

Size cm	Code
Ø5,5	<b>PC55</b>
Ø6,5	<b>PC65</b>
Ø10	<b>PC100</b>
Ø12	<b>PC120</b>



**Tagliapizza**  
Pizza cutters

Size cm	Code
9,5x25	<b>PC001</b>
9,5x30,5	<b>PC002</b>
9,5x35	<b>PC003</b>
9,5x40	<b>PC004</b>



## TAGLIA CROISSANT - CROISSANT CUTTERS

Taglia croissant triangolari acciaio inox e manico ergonomico in plastica.  
Triangular croissant cutters made of stainless steel, with ergonomic plastic handle.



**RDC180X200**  
taglio - cut: b 180 x h 200 mm  
total size: 660 mm



**RTC180X200**  
taglio - cut: b 80 x h 200 mm  
total size: 860 mm



**RSC110X150**  
taglio - cut: b 110 x h 150 mm  
total size: 410 mm



**RSC180X200**  
taglio - cut: b 180 x h 200 mm  
total size: 450 mm



**RSC180X140**  
taglio - cut: b 180 x h 140 mm  
total size: 400 mm



**RSC97X210**  
taglio - cut: b 97 x h 210 mm  
total size: 460 mm

## TAGLIAPASTA - MULTICUTTERS



Tagliapasta inox estendibile  
St. Steel extendable multi-cutters

tipo di lama - blade type (Ø55 mm)	Tagli - cuts:	Code
Liscia - Plain	5	<b>ROTAPINOX 5 P</b>
Ondulata - Wavy	5	<b>ROTAPINOX 5 O</b>
Liscia e Ondulata - Plain and Wavy	5	<b>ROTINOX 5 P/O</b>
Liscia - Plain	7	<b>ROTAPINOX 7 P</b>
Ondulata - Wavy	7	<b>ROTAPINOX 7 O</b>
Liscia e Ondulata - Plain and Wavy	7	<b>ROTINOX 7 P/O</b>

## CANNOLI MOULDS

Stampi per la produzione di cannoli.  
Mould to make cannoli.

Codice - Code	Misura - Size mm	Quantity
<b>50CI22X14</b>	22x140	10 pcs
<b>50CI16X20</b>	16x200	12 pcs
<b>50CI12X20</b>	12x200	12 pcs

Codice - Code	Misura - Size mm	Quantity
<b>50CO30X12</b>	30x120	12 pcs
<b>50CO35X14</b>	35x140	12 pcs
<b>50CO40X16</b>	40x160	12 pcs



Stampi in plastica speciale per la produzione di cannoli.  
Special plastic mould to make cannoli.

Codice - Code	Misura - Size mm	Quantity
<b>CANNOLO</b>	30x120	10 pcs

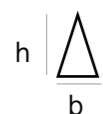

la misura del taglio è riferita al triangolo di pasta lato base (B) x altezza (H)  
the measure of the cut refers to the triangle of dough on the base side (B) x height (H)



## FLACONI - BOTTLES



**Flacone annaffiatore per bagne con copritappo**  
Syrup soaking bottle with cover cap  
**50FLOOC**  
100x56 - h275 mm  
1000ml



**Flacone annaffiatore per bagne**  
Syrup soaking bottle  
**FLACONE**  
70x70 - h270 mm  
1000ml



**Flacone annaffiatore per bagne**  
Syrup soaking bottle  
**FLAN1**  
Ø85 h 250 mm  
1000ml



**Porta Flacone - Bottle holder**  
**50PF00**  
238x110 h 128 mm  
Cap. 4 cod. 50FLOOC  
Bottles not included



**Porta Flacone - Bottles holder**  
**PORTFLACONE**  
250x110 h 80 mm  
Cap. 3 cod. FLACONE  
Bottles not included



**Flaconi**  
Bottles

Codice - Code	Cap. ml
<b>BO100N</b>	100
<b>BO250N</b>	250

Codice - Code	Cap. ml
<b>BO500N</b>	500
<b>BO1000N</b>	1000

## CARAFFE - CARAFES



**Caraffe graduate plastica bianca**  
White plastic graduated carafes

Codice - Code	Cap. ml
<b>CF1</b>	1000
<b>CF2</b>	2000
<b>CF3</b>	3000
<b>CF5</b>	5000



**Caraffe graduate plastica trasparente**  
Transparent plastic graduated carafes

Codice - Code	Cap. ml
<b>CFTRA1</b>	500
<b>CFTRA2</b>	1000
<b>CFTRA3</b>	2000
<b>CFTRA4</b>	3000



**Caraffe graduate plastica trasparente**  
Transparent plastic graduated carafes

Codice - Code	Cap. ml
<b>CFTRA6</b>	6000

## CIOTOLE - BOWLS



**Ciotola in Policarbonato trasparente**  
Transparent polycarbonate bowls

Codice - Code	Cap. ml	Size cm
<b>52BO13PC</b>	400	Ø 13
<b>52BO17PC</b>	1000	Ø 17
<b>52BO23PC</b>	2500	Ø 23
<b>52BO28PC</b>	4000	Ø 28
<b>52BO32PC</b>	8000	Ø 32
<b>52BO38PC</b>	10000	Ø 38



**Ciotola in Polipropilene bianco**  
White polypropylene bowls

Codice - Code	Cap. ml	Size cm
<b>52BO13PP</b>	400	Ø 13
<b>52BO17PP</b>	1000	Ø 17
<b>52BO23PP</b>	2500	Ø 23
<b>52BO28PP</b>	4000	Ø 28
<b>52BO32PP</b>	8000	Ø 32
<b>52BO38PP</b>	10000	Ø 38



## GUANTI - GLOVES



**GL1**  
250°C  
17x38cm  
CE approved.



**GL2**  
250°C  
17x45cm  
CE approved.



**GL3**  
250°C  
17x36 cm  
CE approved.



**GL10**  
100% cotone - cotton  
27x15cm



**GL11**  
100% cotone - cotton  
34x15cm



**GL25PRE**  
25x35cm

**GL18PRE**  
18x25cm

## CAPPELLI IN CARTA - PAPER HATS



**CAP 1**  
Regolabile - Adjustable  
10 pcs - h 210 mm

**CAP 1B**  
Versione Economica  
Economic version



**CAP 2B**  
Regolabile (Versione Economica)  
Adjustable (Economic version)  
10 pcs - h 250 mm



**CAP 3**  
Regolabile - Adjustable  
10 pcs - h 200 mm



**CAP 4**  
25 pcs - 280x h85mm

## PENNELLI - PASTRY BRUSHES



**Setola naturale** lunga 55mm  
**Natural bristle** 55mm

Misura - Size	Code
20mm	<b>PEM20</b>
30mm	<b>PEM30</b>
40mm	<b>PEM40</b>



**Setola sintetica** lunga 70mm  
**Synthetic bristle** 70mm

Misura - Size	Code
20mm	<b>PEMS20</b>
30mm	<b>PEMS30</b>
40mm	<b>PEMS40</b>

## SPAZZOLE - BRUSHES



**SPZ SE**  
400x40 mm  
Temp. MAX 90° C



**SPZ PL3**  
400x40 mm  
Temp. MAX 130° C



**SPZ PL1**  
210x65 mm  
Temp. MAX 130° C



**SPZ INOX**  
145x55 mm

## SESSOLE - FLOUR SCOOPS

Codice - Code	Cap. ml
<b>SES 100</b>	125
<b>SES 250</b>	250
<b>SES 500</b>	512
<b>SES 800</b>	857
<b>SES 1500</b>	1520





## BIG CREMINO

MISURA - SIZE  
CREMINO

48X60CM

### TL SPECIAL

L'articolo include

- 1 Base polietilene
- 1 spatola in plastica
- 2 telai 365x365 h5mm.
- 2 telai 365x365 h3mm.

The article includes

- 1 Polyethylene base
- 1 plastic spatula
- 2 frames 365x365 h5mm.
- 2 frames 365x365 h3mm.



Parti di ricambio  
Spare parts

Desc	Cod.
Telaio - Frame h 3 mm	<b>TLS03</b>
Telaio - Frame h 5 mm	<b>TLS05</b>
Spatola - Spatula	<b>SPB</b>

## SMALL CREMINO

MISURA - SIZE  
CREMINO

24X24CM

### TLMINI

L'articolo include

- 1 Base polietilene
- 1 spatola in plastica
- 2 telai h5mm.
- 2 telai h3mm.

The article includes

- 1 Polyethylene base
- 1 plastic spatula
- 2 frames h5mm.
- 2 frames h3mm.



Parti di ricambio  
Spare parts

Desc	Cod.
Telaio - Frame h 3 mm	<b>TLM03</b>
Telaio - Frame h 5 mm	<b>TLM05</b>
Spatola - Spatula	<b>SPB40</b>



## TELAIO - FRAMES

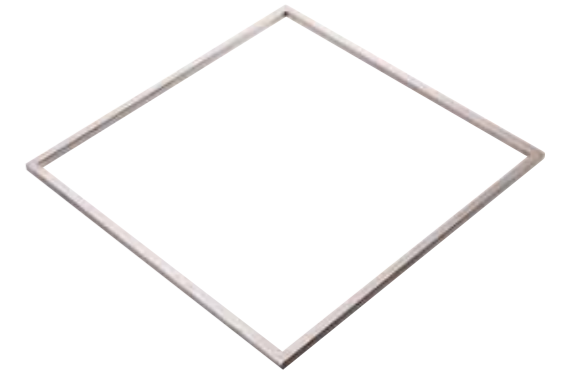

Cremino	Cod.
360x360 h3mm	<b>QG3</b>
360x360 h5mm	<b>QG5</b>

Cremino	Cod.
360x360 h10mm	<b>QG10</b>
360x360 h15mm	<b>QG15</b>

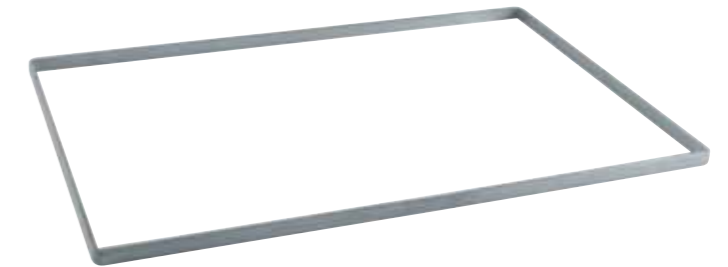

### Telai plastica Plastic frames

Misura - Size mm	Code	Misura - Size mm	Code
570x370 h 1,5	<b>TL 02</b>	570x370 h 4	<b>TL 04</b>
570x370 h 3	<b>TL 03</b>	570x370 h 5	<b>TL 05</b>

Telaio per stesura biscuit, cioccolato e altri impasti.  
Frame to spread biscuit, chocolate and other doughs.  
Misura esterna - External Size: 67x47 cm

### Telaio inox St steel frame

Misura - Size mm	Code
580x380 h 15	<b>TL 15</b>

Telaio inox per Charlotte.  
St. steel frame for Charlotte.  
Misura esterna - External Size: 59x39 cm

## RACLE - SPATULAS



### Racle in plastica - Plastic spatulas

Misura - Size mm	info	Code
555 h80		<b>SPB</b>
620x140	x cod: CSM060	<b>CSMSPB60</b>
420x120	x cod: CSM040	<b>CSMSPB40</b>
270x65	x cod: CHITMINI	<b>SPBMINI</b>

### Racla inox - St. Steel tool

Misura - Size mm	Code
500x180 h60	<b>SPB SPECIAL</b>

Racla inox che permette la stesura uniforme  
con possibilità di regolare lo spessore dell'impasto.  
St. steel tool that allows to spread uniformly different doughs,  
adjusting the thickness.



## PIASTRA RISCALDANTE

Piano in acciaio riscaldato elettricamente per la lavorazione del cioccolato e di altri alimenti.  
Struttura in materiale plastico con ripiano inox removibile.  
Temperatura max 55° C. Disponibile 110 V su richiesta.

Electrical Heating surface for chocolate and other food. Plastic structure with removable st. steel plate.  
Temperature max 55° C. Available 110 V on demand.

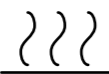

**PR001**

Misura - Size: 32x40 h11,5cm  
230V - 50/60Hz - 0,35A - 80W

## TERMOMETRI - THERMOMETERS

Termometri digitali per cioccolato  
Digital thermometers for chocolate



**50T001**

Celsius -50°C ~ 150°C  
Fahrenheit -58°F ~ 302°F



**50T002**

Celsius -50°C ~ 420°C  
Fahrenheit -58°F ~ 788°F

## PALLINATORE - BALL MACHINE

Strumento ideale per la produzione di "Baci di Dama", praline e palline di marzapane.  
Special plastic machine to produce "Lady's Kisses", pralines and marzipan balls.

Misura - Size mm	Code
16	<b>PALL1</b>
19	<b>PALL2</b>
24	<b>PALL3</b>



## GRIGNOTTINA - COOKIES MAKER

Per ottenere "Grignottines" o "Brutti ma Buoni"  
Machine for crispy cookies

Misura - Size mm	Code
600x400 h50	<b>CIOK 1</b>



Composto da: 1 telaio in plastica senza fondo - 2 teglie forate (Ø30 - 40 mm) - 1 spatola in plastica  
Composed of: 1 Plastic saucepan without bottom - 2 Perforated trays (Ø30 - 40 mm) - 1 Plastic spatula



## GIRATORTA - CAKE TURNTABLE



**GIRA**  
Ø32 h10cm



**GIRA2**  
Ø31 h5,5cm



**40-W125**  
Ø23 h14cm  
Inclinabile - Tilting



**GIRA3**  
41x31 h9,5cm  
Acciaio



**NEW GIRA5**  
Ø29cm



**NEW GIRA6**  
Ø30cm



**Segnaporzioni in plastica Ø25cm**  
Plastic cake markers

Fette - Slices	Code
8-12	<b>PPT 8/12</b>
12-16	<b>PPT 12/16</b>
14-16	<b>PPT 14/16</b>
12-18	<b>PPT 12/18</b>
14-18	<b>PPT 14/18</b>
12	<b>PPT 12</b>



**Segnaporzioni acciaio Ø33cm**  
Stainless steel cake markers

Fette - Slices	Code
8	<b>PPT 8X</b>
10	<b>PPT 10X</b>
12	<b>PPT 12X</b>
14	<b>PPT 14X</b>
16	<b>PPT 16X</b>
18	<b>PPT 18X</b>



**Stampo decora crostate**  
Cutter for tarts

**DECOR 30**  
Ø300 mm

Porzionatori utilizzabili in entrambi i lati.  
Double face cake markers.

## SOTTOTORTA - PLASTIC PLATES

**Dischi in plastica**  
Plastic plates

Size cm	Code
Ø20	<b>DISCO20</b>
Ø22	<b>DISCO22</b>
Ø24	<b>DISCO24</b>
Ø26	<b>DISCO26</b>
Ø28	<b>DISCO28</b>
Ø30	<b>DISCO30</b>
Ø32	<b>DISCO32</b>
Ø34	<b>DISCO34</b>



**Kit completo**  
Complete kit  
**SETDISK**  
8 pcs (PST)

## LIRA - CAKE SLICER

Lira per pan di spagna.  
3 lame altezza variabile: da 10 a 90 mm.  
Sponge cake slicer.  
In 3 different heights: from 10 until 90 mm.

**Lira per pan di spagna**  
Sponge cake slicer

**CS3**  
460mm



## PALA PER DOLCI - CAKE LIFTER

**Pala per dolci**  
Cake lifter  
**TS1**





# RASCHIETTI IN PLASTICA - PLASTIC SCRAPERS

Confezioni 10 pezzi - Packs 10 pieces



Mod.	Misura - Size	Code
rigido - rigid	145x95mm	<b>50RTD1</b>



Mod.	Misura - Size	Code
rigido - rigid	150x110mm	<b>50RTF1</b>
morbido - soft	150x110mm	<b>50RTF2</b>



Mod.	Misura - Size	Code
rigido - rigid	145x95mm	<b>50RTL1</b>
morbido - soft	145x95mm	<b>50RTL2</b>



Mod.	Misura - Size	Code
rigido - rigid	120x90mm	<b>50RTP1</b>
morbido - soft	120x90mm	<b>50RTP2</b>



Mod.	Misura - Size	Code
rigido - rigid	125x90mm	<b>50RTA1</b>
morbido - soft	125x90mm	<b>50RTA2</b>



Mod.	Misura - Size	Code
rigido - rigid	140x90mm	<b>50RTO1</b>
morbido - soft	140x90mm	<b>50RTO2</b>



Mod.	Misura - Size	Code
rigido - rigid	150x150mm	<b>50RTV1</b>
morbido - soft	150x150mm	<b>50RTV2</b>



Mod.	Misura - Size	Code
rigido - rigid	215x130	<b>50RTT1</b>



Mod.	Misura - Size	Code
rigido - rigid	195x150mm	<b>50RTS1</b>

# RASCHIETTI IN ACCIAIO - STEEL SCRAPERS



Misura - Size	Code
130X100mm	<b>50RAS1</b>
175X100mm	<b>50RAS2</b>



Misura - Size	Code
145X195mm	<b>RAS 3</b>



Misura - Size	Code
145X170mm	<b>RAS 4</b>
245mm	<b>RAS 5</b>
295mm	<b>RAS 6</b>



Misura - Size	Code
120mm	<b>RAS 7</b>
200mm	<b>RAS 8</b>

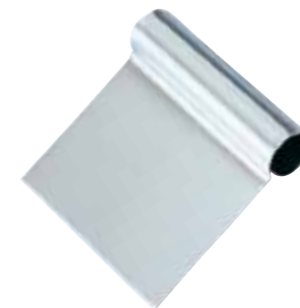

Raschie per cioccolato  
Scrapers for chocolate

Misura - Size	Code
105x105mm	<b>RD105</b>
125x105mm	<b>RD125</b>
150x105mm	<b>RD150</b>
175x105mm	<b>RD175</b>



Raschie per cioccolato  
Scrapers for chocolate

Misura - Size	Code
120x115	<b>RC115</b>



Raschie per cioccolato  
Scrapers for chocolate

Misura - Size	Code
120x110	<b>RC110</b>

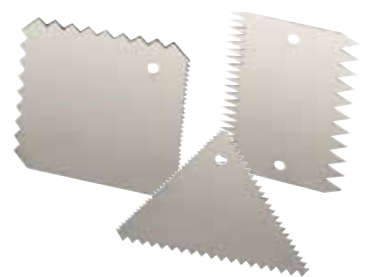

Kit 3 pcs

Misura - Size	Code
100x100	<b>INOX 3</b>



# SET TAGLIA PASTA - KIT CUTTERS



Set tagliapasta in scatola  
Box cutters set



**CUT5L7**  
7 pcs  
65 - 57 - 50 - 45 - 40 - 35 - 27



**CUT6L7**  
7 pcs  
90x60 - 80x50 - 70x45 - 60x40  
50x30 - 40x25 - 30x20



**CUT20L7**  
7 pcs  
90 - 75 - 70 - 55 - 45 - 40 - 25



**CUT21L7**  
7 pcs  
90x65 - 80x55 - 70x50 - 55x40  
45x33 - 35x25 - 27x20



**CUT26L7**  
7 pcs  
90 - 80 - 70 - 55 - 40 - 35 - 30



**CUT27L7**  
7 pcs  
90 - 80 - 70 - 55 - 40 - 35 - 30



**CUT22L7**  
7 pcs  
65x50 - 60x45 - 55x40 - 50x35  
47x32 - 43x28 - 37x25



**CUT3L7**  
7 pcs  
75 - 67 - 63 - 57 - 52 - 47 - 42



**CUT8L7**  
7 pcs  
90x60 - 80x50 - 70x45 - 65x40  
55x33 - 45x25 - 35x20



**CUT9L7**  
7 pcs  
90x60 - 85x55 - 75x50 - 65x43  
55x40 - 50x32 - 40x25



**CUT24L7**  
7 pcs  
90x50 - 80x46 - 75x43 - 70x40  
60x35 - 55x33 - 50x30



**CUT25L7**  
7 pcs  
90x50 - 80x46 - 75x43 - 70x40  
60x35 - 55x33 - 50x30



**CUT29L7**  
7 pcs  
80x50 - 75x45 - 68x40 - 62x37  
55x33 - 50x29 - 44x25



**CUT28L7**  
7 pcs  
100x50 - 90x45 - 85x43 - 75x40  
70x35 - 60x30 - 55x25



**CUT4L7**  
7 pcs  
75 - 70 - 65 - 60 - 55 - 50 - 45



**CUT16L7**  
7 pcs  
80 - 75 - 67 - 60 - 50 - 40 - 33



**CUT14L7**  
7 pcs  
85 - 80 - 75 - 70 - 65 - 55 - 45



**CUT31L7**  
7 pcs  
90 - 80 - 70 - 60 - 50 - 40 - 30



**CUT18L7**  
7 pcs  
90x65 - 80x60 - 70x50 - 55x40  
45x30 - 33x23 - 25x18



**CUT19L7**  
7 pcs  
95 - 85 - 75 - 70 - 60 - 50 - 45



**CUT30L7**  
7 pcs  
95x60 - 85x50 - 70x45 - 55x38  
45x30 - 35x25 - 25x18



**CUT15L7**  
7 pcs  
86x45 - 76x38 - 68x33 - 61x30  
55x25 - 49x21 - 42x17



**CUT10L9**  
9 pcs  
37 - 51 - 66 - 82 - 96 - 110  
125 - 137 - 150



**CUT17L7**  
7 pcs  
75x55 - 70x50 - 50x45 - 55x45  
50x37 - 45x33 - 35x27



**CUT23L7**  
7 pcs  
95 - 85 - 75 - 60 - 45 - 35 - 30



**CUT12L7**  
7 pcs  
90 - 80 - 65 - 53 - 42 - 55 - 30



**TPGSET**  
set 9 cutter



**TPGSET/2**  
set 7 cutter



**TPMSET**  
set 9 cutter





**Tondi lisci**  
Round Smooth

7 pcs  
**CUT1L7**

30-40-50-60  
70-80-90

9 pcs  
**CUT1L9**

30-40-50-60-70  
80-90-100-110

12 pcs  
**CUT1L12**

30-40-50-60-70-80-90  
100-110-120-130-140

16 pcs  
**CUT1L16**

20-30-40-50-60-70  
75-80-85-90-95-100  
110-120-125-140

**Tondi Ondulati**  
Round Wavy

9 pcs  
**CUT1F9**

30-40-50-60-70-80  
90-100-110

12 pcs  
**CUT1F12**

30-40-50-60  
70-80-90-100  
110-120-130-140



**Ovali lisci**  
Oval smooth

7 pcs  
**CUT2L7**

85x70-75x65-65x55-55x45  
45x35-35x25-23x18

9 pcs  
**CUT2L9**

27x34-33x46-42x57-51x68  
62x78-71x87-82x97-92x107  
102x117

12 pcs  
**CUT2L12**

40x30-50x40-60x50-70x60  
80x70-90x80-100x90  
110x100-120x110-130x120  
140x120-150x130

**Ovali Ondulati**  
Oval Wavy

9 pcs  
**CUT2F9**

27x34-33x46-42x57-51x68  
62x78-71x87-82x97-92x107  
102x117

12 pcs  
**CUT2F12**

40x30-50x40-60x50-70x60  
80x70-90x80-100x90  
110x100-120x110-130x120  
140x120-150x130



**Cuori lisci**  
Heart smooth

7 pcs  
**CUT7L7**

35-40-45-55-65-75-85

9 pcs  
**CUT7L9**

36-43-52-60-70  
80-90-100-110

12 pcs  
**CUT7L12**

36-43-52-60-70-80-90-100  
110-120-130-140

**Cuori Ondulati**  
Heart Wavy

9 pcs  
**CUT7F9**

60-70-80-90-100  
110-120-130-140

**TAGLIA PASTA - CUTTERS**

Taglia pasta in acciaio inox , con manico.  
Stainless steel cutter, with handle.

**Ondulati - Wavy**

**CUT1FM12**  
Ø 120 x h20 mm

**CUT1FM14**  
Ø 140 x h20 mm

**Lisci - Smooth**

**CUT1LM12**  
Ø 120 x h20 mm

**CUT1LM14**  
Ø 140 x h20 mm



**CUT12LM1**  
Ø 89 x h20 mm



**CUT23LM1**  
Ø91 x h20 mm



**CUT15LM1**  
Ø 100 x h20 mm



**Kit Mele - Apples**  
**CUT80LM3**  
Ø45 x h20 - Ø60 x h20 - Ø85 x h20



**Kit tulipani - tulips**  
**CUT17LM2**  
60x45 x h20 - 73x55 x h20



**Kit Cuore - Heart**  
**CUT19LM3**  
Ø65 x h20 - Ø50 x h20 - Ø80 x h20



**Kit Farfalla - Butterfly**  
**CUT50LM2**  
Ø60 x h20 - Ø90 x h20



**Kit Orsetto - Bear**  
**CUT60LM2**  
Ø65 x h20 - Ø80 x h20



**Kit Coniglio - Rabbit**  
**CUT70LM2**  
Ø65 x h20 - Ø80 x h20



**Kit Cuore - Heart**  
**CUT27LM3**  
Ø55 x h20 - Ø65 x h20 - Ø80 x h20

**MINI TAGLIA PASTA - MINI CUTTERS**

**Set tagliapasta inox per praline - St. Steel praline cutters set**  
**PRA9**

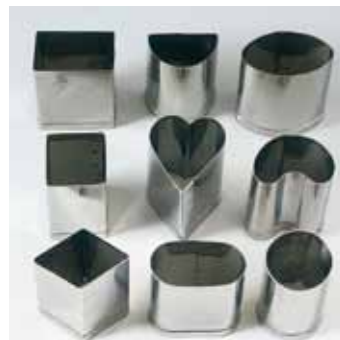

35x20 h5 30x15 h5 40x23 h5 25x25 h5 35x30 h5 35x18 h5 40x26 h5 40x20 h5 Ø26 h5

**Farfalla - Butterfly**  
**CUT50LM1**  
Ø100 x h20

**Orsetto - Bear**  
**CUT60LM1**  
Ø100 x h20

**Coniglio - Rabbit**  
**CUT70LM1**  
Ø100 x h20

**Cuore - Heart**  
**CUT27LM1**  
Ø79 x h20 mm



# GRIGLIE TAGLIA PASTA - PLASTIC CUTTERS

Griglia Taglia biscotti - Biscuit cutter frame  
60x40cm



Cuori - Hearts  
GTB01



Halloween  
GTB02



Natale - Christmas  
GTB03



Pasqua- Easter  
GTB04



Fiori Foglie - Flowers Leaves  
GTB05



Anim. domestici - Animals  
GTB06



Animali selvaggi - Wild animals  
GTB07



Frutta - Fruit  
GTB08



Animali marini - Marine animals  
GTB09



Trasporti - Transport  
GTB10



Carte da gioco - Cards  
GTB11



Musica - Music  
GTB12



Osso - Bone  
GTB14



Tondo festonato - Wavy round  
GTB15



Tondo - Round  
GTB16



Stella - Star  
GTB17



Croce Festonata - Wavy Cross  
GTB18



Cuore - Heart  
GTB19



Luna - Moon  
GTB20



Tris  
GTB21



Uovo - Egg  
GTB22



Carnevale - Carnival  
GTB23  
occhi-eyes cutter



Biscotti San Martino  
GTB13  
100x77mm



Dolce San Martino  
SMA320 320x340 mm  
SMA260 260x280 mm  
SMA180 180x200 mm  
SMA110 110x125 mm





## TAGLIERI - CUTTING BOARD



NEW

**Tagliere gastronomia**  
Gastronomy cutting board

**TAG8**

56x30 h10,5cm  
vaschette in acciaio - steel tanks cap 0,8 Lt  
Piano di lavoro in plastica (polietilene)  
Plastic worktop (polyethylene)

NEW

**Tagliere gastronomia**  
Gastronomy cutting board

**TAG9**

65x39 h10,5cm  
vaschette in acciaio - steel tanks cap 1,5 Lt  
Piano di lavoro in plastica (polietilene)  
Plastic worktop (polyethylene)

**Taglieri**  
Cutting board

Piano di lavoro in plastica (polietilene)  
Plastic worktop (polyethylene)



**TAG4**

40x30 h3 cm

**TAG5**

50x30 h3 cm

NEW

**Taglieri con paratia**  
Cutting board with bulkhead

Piano di lavoro in plastica (polietilene)  
Plastic worktop (polyethylene)



**TAG6**

41,5X30 h18 cm

**TAG7**

51,5X30 h18 cm

## TEGLIE FORATE - PLASTIC PANS

Teglie in materiale plastico forate di vari diametri.  
Plastic pans with circles of different diameters.  
Spessore - Thickness 8 mm. Misura - Size: 59x39 cm.

Size mm	Prod.	Code	Size mm	Prod.	Code
Ø80	8 pcs	<b>TFP8</b>	Ø180	6 pcs	<b>TFP18</b>
Ø100	8 pcs	<b>TFP10</b>	Ø200	4 pcs	<b>TFP20</b>
Ø120	8 pcs	<b>TFP12</b>	Ø220	3 pcs	<b>TFP22</b>
Ø140	8 pcs	<b>TFP14</b>	Ø240	2 pcs	<b>TFP24</b>
Ø160	6 pcs	<b>TFP16</b>	Ø260	2 pcs	<b>TFP26</b>

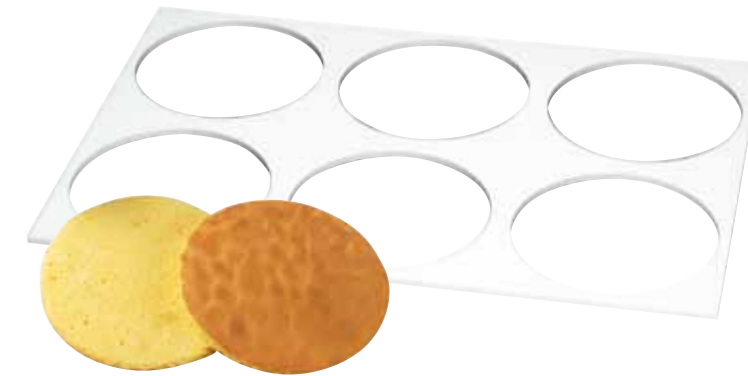

Per il taglio del biscuit in perfette strisce  
To cut biscuit obtaining regular stripes

**Griglie trasparenti**  
Transparent grills

**GD2/4**

Griglia speciale per tagli da 2 e 4 cm.  
Special grill to cut 2 and 4 cm.

**GD3/6**

Griglia speciale per tagli da 3 e 6 cm.  
Special grill to cut 3 and 6 cm.



**Righe trasparenti in plastica**  
Plastic transparent rulers

**RIGA64**

5 Divisioni da 12 cm  
e 7 divisioni da 8 cm.  
5 Divisions for 12 cm  
and 7 divisions for 8 cm.

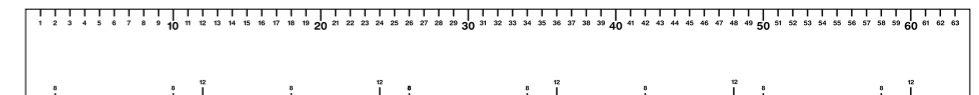

**Kit 2 righe - kit 2 rulers**

**RIGAKIT**

adatte per teglie 60X40 cm.  
Possibilità di dividere il prodotto  
in 3-4-5-6-7-8-9-10 parti.  
for 60x40 cm trays.  
It is possible to divide the cake  
in 3-4-5-6-7-8-9-10 shares.

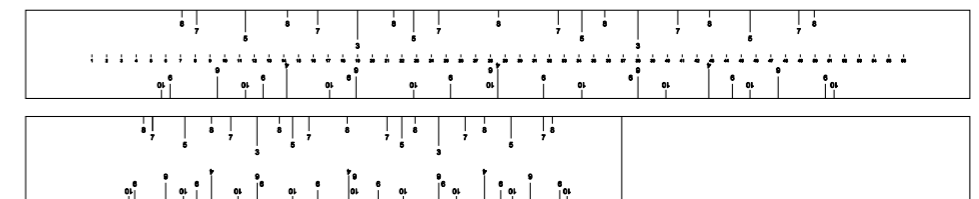



## STAMPI PANE - BREAD MOULDS



**STPTA 6**  
Ø8cm



**STPTA 7**  
Ø8cm



**STPTA 10**  
Ø8cm



**STPTA 13**  
Ø8cm

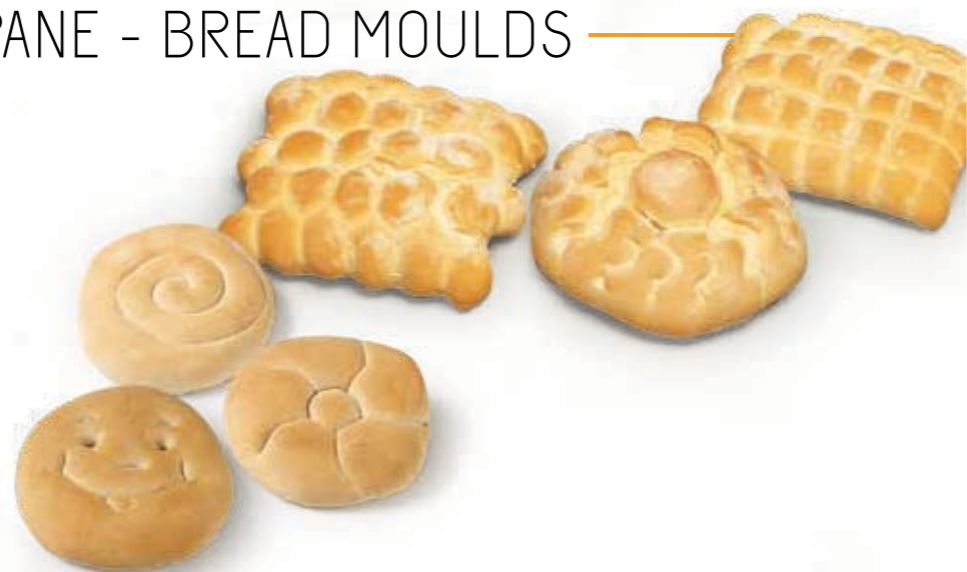

**STPTA 8**  
Ø8cm



**STPTA 11**  
Ø8cm



**STPTA 14**  
Ø8cm



**STPTA 9**  
Ø8cm



**STPTA 12**  
Ø8cm



**STPZ**  
Ø8cm



**STPTA 1**  
14x10cm



**STPTA 2**  
14x11cm

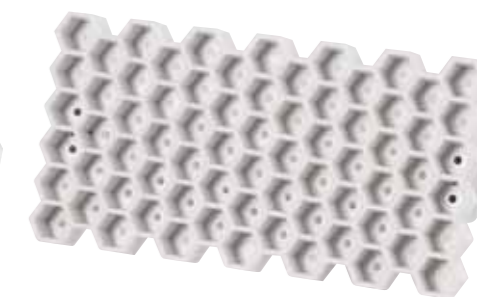

**STPTA 4**  
16,5x8,5cm



**STPTA 5**  
Ø12,5cm



**STPTA 3**  
Ø12,5cm



**STPK**  
Marcatore girevole per pane kaiser  
Kaiser bread marker

## CESTINI PANE - BREAD BASKET

Cestini per lievitazione  
Leavening bread baskets



Cap. gr	Size cm	Code
1500	Ø25	<b>BASKET 205</b>
1000	Ø21,5	<b>BASKET 206</b>
500	Ø18	<b>BASKET 207</b>
250	Ø13	<b>BASKET 208</b>



Cap. gr	Size cm	Code
1500	40x14	<b>BASKET 105</b>
1000	35x13	<b>BASKET 106</b>
500	27x12	<b>BASKET 107</b>



Cap. gr	Size cm	Code
1000	29x18	<b>BASKET 102</b>
500	22x14	<b>BASKET 103</b>
750	24x14	<b>BASKET 108</b>



## TAGLIERINI - BREAD CUTTERS



**CUTTER7**



**CUTTER8**



**CUTTER9**



**CUTTER4**



**CUTTER12**



**CUTTER13**  
kit 2 pcs



**CUTTER1**



**CUTTER15**



**CUTTER14**



**CUTTER10**



**CUTTER5**  
1 Cutter + 25 lame/blades



**CUTTER5/A**  
1 Cutter

## TELI PANE - BREAD SHEETS

**Teli pane in nylon trasparente**  
**Transparent nylon bread sheets**

**55TP6080**

Misura - Size: 60x80 cm  
pack 50 pcs  
70 micron

**55TP22080**

Misura - Size: 220x80 cm  
pack 50 pcs  
70 micron



## COPERTURA CARRELLI - TROLLEYS COVER



**NEW**

**Copertura monosheet per carrelli**

**50CP01**

Misura - Size:  
GN 2/1 60x40 h 180 cm  
roll 200 pcs - 20 micron



**NEW**

**Staffa inox da muro porta rotolo**

**50ST01**

Staffa porta rotolo 50CP01



## SEGNAPREZZI - PRICE CARDS



**SEG001N**  
70x40mm  
15 pcs

**SEG002N**  
60x80mm  
25 pcs

**SEG003N**  
45x65mm  
30 pcs

**SEG004N**  
35x40mm  
30 pcs

**SEG005N**  
55x80mm  
50 pcs

**SEG006N**  
60x80mm  
40 pcs



**SEG008N**  
60x90mm  
25 pcs

**SEG015N**  
60x50mm  
50 pcs

**SEG024N**  
55x92mm  
25 pcs

**SEG025N**  
62x86mm  
25 pcs

**SEG027N**  
65x62mm  
15 pcs

## PINZE - PINCERS



**PINZAX1**  
Pinze in acciaio inox  
St. Steel pincers  
190x17mm

**PINZAX2**  
Pinze in acciaio inox  
St. Steel pincers  
190x36mm

**PINZAX3**  
Pinze in acciaio inox  
St. Steel pincers  
190x38mm

**PINZAX4**  
Pinze in acciaio inox  
St. Steel pincers  
190x58mm

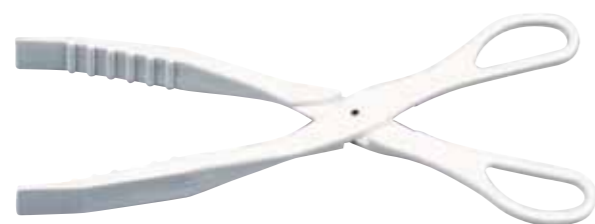

**PINZA**  
Pinza in plastica  
Plastic pincer

## ESPOSITORI - SALES DISPLAY

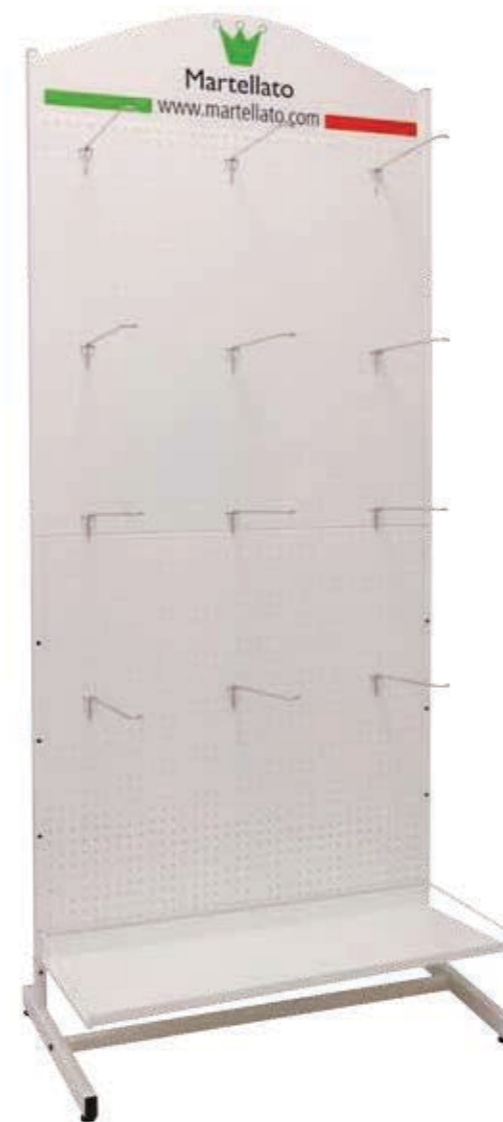

**Espositore in metallo**  
**Metal display**  
**ESPOSITORE**  
95x55 h210 cm  
con 20 ganci inclusi  
with 20 hooks included  
  
Crownner incluso  
Crownner included



**Espositore in legno**  
**Wooden display**  
**ESPOWMONOUSO**  
78,5x52 h195 cm

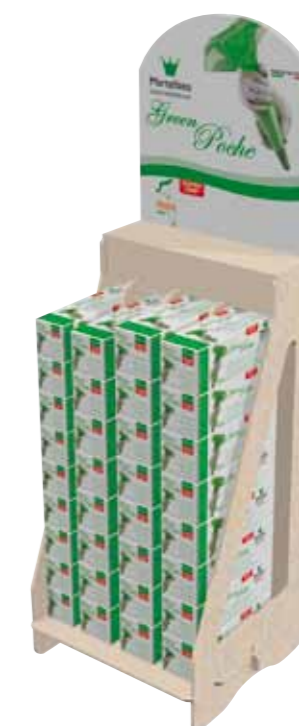

**Espositore in legno per green poche**  
**Standing wooden display for green poche**  
**ESPOWG70GP**  
Misura/Size:  
49,4x46,5 h150 cm



# ATTREZZATURA ZUCCHERO SUGAR EQUIPMENTS

Ideata per la lavorazione dello zucchero. Realizzata in metallo verniciato e acciaio spazzolato.  
Regolazione del corpo lampada in altezza ed in inclinazione. Controllo della potenza su 2 livelli: 600- 1200W.  
Piano di lavoro :625 x 450 mm - Completa di cablaggio elettrico.

Designed for sugar processing. Made in varnished metal and brushed steel.  
Height and tilt adjustment of the lamp body. 2-level power control: 600- 1200W.  
Working plane :625 x 450 mm. Complete with electric cable.

Cavo di alimentazione posizionato all'interno per una maggiore sicurezza  
The power cable runs inside the pole for improved safety

Inclinazione di 40° del corpo lampada verso l'operatore

40 ° inclination of the lamp towards the operator

Scorrimento verticale  
Vertical scrolling

Base perfettamente planare  
Perfectly planar base

Maniglia per regolare l'inclinazione della lampada  
Handle to adjust the lamp inclination

Smontaggio rapido  
Quick disassembly



**NEW**  
Lampada  
Lamp  
**LAMP01**

Paratia antivento acciaio inox  
Stainless steel shelter  
**LAMPLEX**

## CHEF'S TORCH



**CANNELLO PRO**  
Cartuccia non inclusa.  
Cartridge not included.



**CANNELLOBL**  
Cartuccia non inclusa.  
Cartridge not included.



**CANNELLOBIG**  
Cartuccia non inclusa.  
Cartridge not included.

Caramellizzatore  
Caramelizer  
**MCAR**  
230V/50Hz



**NEW**  
Porta phon  
Blow dryer holder  
**50PP01**



Forbici da zucchero  
Sugar scissors  
**50F001**



Pompetta  
Sugar pump  
**POMP**



Supporto termometro  
Thermometer holder  
**MRTE**  
h13,7cm



Caramellometro  
Caramellometer  
**MTE**  
da +80°C a +200°C  
h30cm

### Guanti in lattice - Latex gloves

Taglia - Size	Code	Taglia - Size	Code
6 - 6 1/2	<b>GL 6</b>	8 - 8 1/2	<b>GL 8</b>
7 - 7 1/2	<b>GL 7</b>	9 - 9 1/2	<b>GL 9</b>





# PLEXIGLASS DISPLAYS



## MACARON



**AG05801**  
315x325 h65 mm



**AG05701**  
460x330 h145 mm



**AG05601**  
270x330 h145 mm



**AG07801**  
270x150 h480 mm  
cap. 25 pcs



**AG07901**  
350x350 h450 mm  
cap. 60 pcs



**AG08201**  
400x350 h280 mm  
cap. 15/18 pcs



**AG07701**  
Ø280 h430 mm  
cap. 62 pcs



**AG07701P**  
Ø240 h 280 mm  
cap. 30 pcs



**AG08101**  
55x350 h600 mm  
cap. 9 pcs



## VETRINE - SHOW WINDOWS



Porta brioches in plexiglass  
Plexiglass showcase

Size cm	Code
37x31 - h31	<b>VB00408</b>



Porta brioches in plexiglass con led  
Plexiglass showcase with led lights

Size cm	Code
39,5x32,5 - h50,5	<b>VB00308</b>



Porta brioches in plexiglass  
Plexiglass showcase - 42x31 h 42,5

Colore - Color	Code
Bianco - White	<b>VB00200</b>
Trasp. - Trans.	<b>VB00201</b>
Nero - Black	<b>VB00208</b>



Apertura frontale e posteriore  
Front opening and back opening

Size cm	Code
60x37 - h36	<b>VB00102</b>



Porta brioches in plexiglass  
Plexiglass showcase

Size cm	Code
41x36,5 - h44	<b>VB00306</b>



Vetrine porta brioches riscaldanti  
Warming showcases for croissants

Size cm	Size cm	Code
1 piano-shelv	35x49,5 h 33	<b>VB00108</b>
2 piani-shelves	35x49,5 h 39	<b>VB00110</b>



Proteggi Brioches  
Plexiglass food shields

Size cm	Code
49,5x30 - h27	<b>AR0001</b>
99,5x30 - h27	<b>AR00011</b>



Vetrina Easy  
Plexiglass food shields

Size cm	Code
49,5x31 - h27	<b>AR02801</b>

## VASSOI - TRAYS

### LITTLE DECORO

145 x 400 h 20 mm

Colore - Color	Code
Bianco - White	<b>50VP0100</b>
Nero - Black	<b>50VP0108</b>

145 x 289 h 20 mm

Colore - Color	Code
Bianco - White	<b>50VP0200</b>
Nero - Black	<b>50VP0208</b>

204 x 258 h 20 mm

Colore - Color	Code
Bianco - White	<b>50VP0300</b>
Nero - Black	<b>50VP0308</b>

294 x 394 h 20 mm

Colore - Color	Code
Bianco - White	<b>50VP0400</b>
Nero - Black	<b>50VP0408</b>



### MODERN STYLE

145 x 400 h 20 mm

Colore - Color	Code
Bianco - White	<b>50VP0500</b>
Nero - Black	<b>50VP0508</b>

145 x 289 h 20 mm

Colore - Color	Code
Bianco - White	<b>50VP0600</b>
Nero - Black	<b>50VP0608</b>

204 x 258 h 20 mm

Colore - Color	Code
Bianco - White	<b>50VP0700</b>
Nero - Black	<b>50VP0708</b>

294 x 394 h 20 mm

Colore - Color	Code
Bianco - White	<b>50VP0800</b>
Nero - Black	<b>50VP0808</b>



Su richiesta ampia gamma di colori e  
misure realizzabili  
On request different colors and sizes

plexiglass nero - black plexiglass

Size mm	thickness	Code
600X100	5	<b>50VP601008</b>
600X250	5	<b>50VP602508</b>
250X120	5	<b>50VP251208</b>
200x200	5	<b>50VP202008</b>
250x250	5	<b>50VP252508</b>
200X100	5	<b>50VP201008</b>



vassoio plexiglass - plexiglass tray

Size mm	Code
470x340 - h50	<b>VS00101</b>





# CONTENITORI ISOTERMICI

## ISOTHERMAL CONTAINERS

TOP

### GASTRONORM

**50CI210GN** - Cap. 38,6 Lt  
Internal size: 540x340x210 mm

**50CI280GN** - Cap. 52,3 Lt  
Internal size: 540x340x280 mm

### MAXI 60X40

**50CI316040** - Cap. 82,3 Lt  
Internal size: 625x425x310 mm

**50CI276040** - Cap. 71,7 Lt  
Internal size: 625x425x270 mm



**50CI126040** - Cap. 31,9 Lt  
Internal size: 625x425x120 mm

**50CI086040** - Cap. 21,3 Lt  
Internal size: 625x425x80 mm

**50CI216040** - Cap. 55,8 Lt  
Internal size: 625x425x210 mm

**50CI166040** - Cap. 42,5 Lt  
Internal size: 625x425x160 mm



**Piastra eutettica**  
Eutectic plate  
-21°C / 0°C

**50CIA005**  
Size: 530x525x30 mm  
x GASTRONORM

**50CIA007**  
Size: 600x300x30 mm  
x MAXI



**Piastra eutettica**  
Eutectic plate  
-6°C / 0°C

**50CIA008**  
Size: 380x215x30 mm  
x GASTRONORM  
x MAXI



**Inserto Caldo&Freddo**  
Hot&Cold System insert

**50CIA004**  
Size: 605x405x110 mm  
x GASTRONORM

**50CIA006**  
Size: 695x495x100 mm  
x MAXI



**Carrello plastica**  
Plastic trolley

**50CIA003**  
Size: 610x410 mm

### RING SYSTEM

50x50

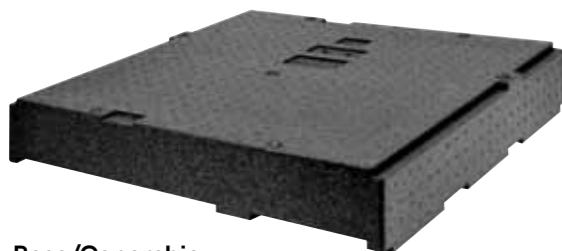

**Base/Coperchio**  
Base/Cover

**50CI5050BC**  
Misure interne - Internal size:  
510x510x63 mm



**Estensore**  
Extensor

**50CI5050ES**  
Misure interne - Internal size:  
510x510x95 mm



FRONTAL

### GASTRONORM

**50CI540GN** - Cap. 83 Lt  
Internal size: 540x330x480 mm

### MAXI 60X40

**50CI6040** - Cap. 128,1 Lt  
Internal size: 600x400x500 mm



Supporti salva guida - Wire rail bracket

**50CIA001**  
for 50CI540GN  
GASTRONORM  
kit 12pcs



**50CIA002**  
for 50CI6040  
MAXI  
kit 9pcs

## PLASTIC BOX



**Casse Milleusi**  
Multipurpose crates

Size cm	Lt	Code
55x43 h 31	50	<b>50CA5543F</b>
63x44 h 34	65	<b>50CA6344F</b>

Casse forate, inseribili e sovrapponibili.  
Insertable and stackable perforated crates.



**Cassa fondo chiuso e pareti chiuse**  
Full bottom and side crate

Size cm	Lt	Code
60x40 h 7	12	<b>50CA604007C</b>
60x40 h 10	18	<b>50CA604010C</b>
60x40 h 13	24	<b>50CA604013C</b>



**Coperchio per casse milleusi**  
Multipurpose crate lids

Size cm	Code
55x43	<b>50CA50COP</b>
63x44	<b>50CA65COP</b>
72x47	<b>50CA90COP</b>



**Coperchio per casse 60x40**  
Crate lid 60x40

Size cm	Code
60x40	<b>50CA6040COP</b>





# DECORAZIONE DECORATION

AEROGRAFIA/AIRBRUSH	294
STENCIL	296
COLORANTI/COLOURANTS	302



# AEROGRAFIA AIRBRUSHING



## AIRBRUSH



**DECOAIR2**  
Cap. 7 CC  
Ø 0,3mm



**DECOAIR3**  
Cap. 2 CC  
Ø 0,2mm



**DECOAIR5**  
Cap. 20 CC - 40 CC  
Ø 0,2mm



**DECOAIR6**  
Cap. 2 CC - 5 CC - 13 CC  
Ø 0,3mm



**DECOMP7**  
BAR 4



**DECOMP9**  
BAR 6

pezzi di ricambio disponibili su richiesta - spare parts available on request

## MINI AIRBRUSH

### DECOCP01

- Il kit per piccole decorazioni include:
- Penna aerografo a doppia azione, Ø 0,2mm;
  - Mini Compressore da 1 BAR;
  - Supporto per penna aerografo;
  - Trousse nera da viaggio.

- The kit for small decorations includes:
- Airbrush double action, Ø 0.2mm;
  - Mini compressor 1 BAR;
  - Support for airbrush;
  - Black travel bag.



## ACCESSORI - ACCESSORIES



**DECOV01**  
Vaschetta per la pulizia dell'aerografo.  
Container for airbrush cleaning.



**DECOF01**  
Filtro per aerografo.  
Airbrush filter.



**DECOH01**  
Sostegno per aerografo.  
Airbrushes holder.



**MD 2**  
Sostegno per aerografo.  
Airbrushes holder.



# STENCIL PLASTICA PLASTIC STENCIL

In materiale plastico per alimenti.  
Misure: Ø260mm. Spessore 8/10.  
Made of food safe plastic.  
Sizes: Ø260mm. Thickness 8/10.

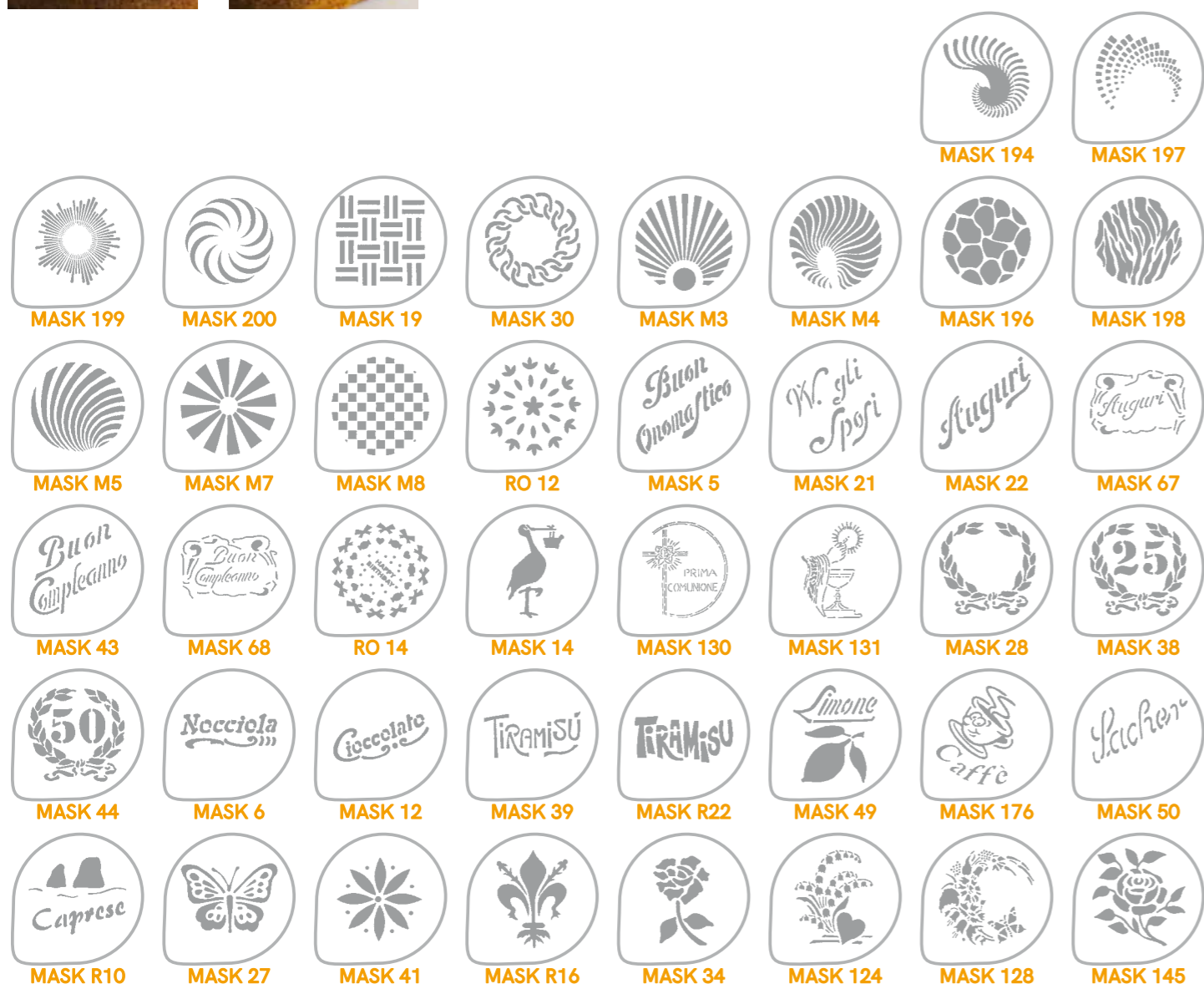

## MINI STENCIL



Mini setaccio - Mini sifter  
**SETACIOK**  
Ø70 h90mm  
Acciaio inox. - St. steel.

In materiale plastico per alimenti.  
Misure: Ø95mm. Spessore 8/10.  
Made of food safe plastic.  
Sizes: Ø95mm. Thickness 8/10.

Ideali per monoporzioni  
Ideal for single serving





## CREATIVE STENCIL

Plastica bianca.  
White plastic stencil.  
Misura - Size 295x200mm



**PMFORK**  
30x125 x h1,5mm - 12pcs

**PMSPOON**  
30x130 x h1,5mm - 12pcs

**PMKNIFE**  
20x130 x h1,5mm - 14pcs



Plastica trasparente - Transparent plastic stencil.  
Misura - Size 310x510mm



**SCSP01**  
130x30 x h2mm - 30pcs

**SCSP03**  
75x35x h2mm - 40pcs

**SCSP04**  
65x40 x h2mm - 32pcs

## TIRAMISÙ STENCIL

Griglia tiramisù per decorare il dolce e segnare le porzioni.  
Tiramisù grill to decorate the cake and mark portions.

**Stencil porzionatore**  
**Cake marker stencil**  
**GPO22**  
40x30cm



## MARZIPAN TOOLS



**Coltello - Knife**  
**50WA006B**  
1 coltello / 1 knife

**Kit marzapane - Marzipan kit**  
**50WA004B**  
1 valigetta - 1 coltello  
1 raschietto - 12 bastoncini  
1 case - 1 knife - 1 scraper - 12 tools

**Kit marzapane - Marzipan kit**  
**50WA005B**  
1 valigetta - 1 coltello  
1 raschietto - 12 bastoncini  
1 case - 1 knife - 1 scraper - 12 tools

## STENCIL DECORATIVI DECORATIVE STENCIL



Griglie in materiale plastico per biscuit.  
Plastic grills for decorated biscuit.

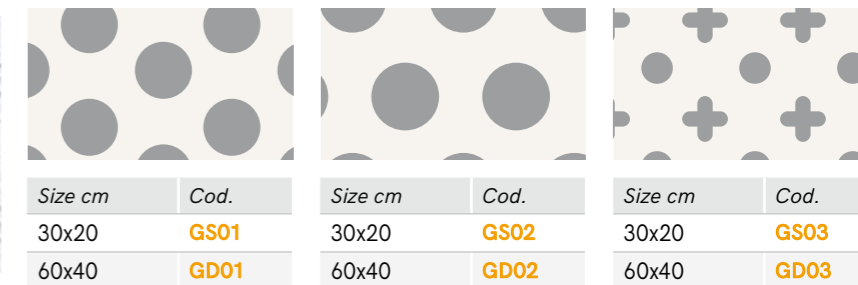

Size cm	Cod.
30x20	<b>GS01</b>
60x40	<b>GD01</b>

Size cm	Cod.
30x20	<b>GS02</b>
60x40	<b>GD02</b>

Size cm	Cod.
30x20	<b>GS03</b>
60x40	<b>GD03</b>

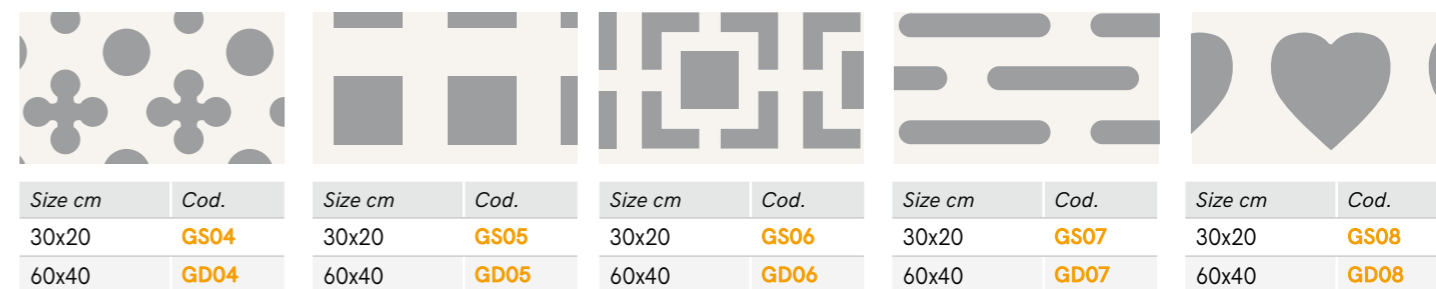

Size cm	Cod.
30x20	<b>GS04</b>
60x40	<b>GD04</b>

Size cm	Cod.
30x20	<b>GS05</b>
60x40	<b>GD05</b>

Size cm	Cod.
30x20	<b>GS06</b>
60x40	<b>GD06</b>

Size cm	Cod.
30x20	<b>GS07</b>
60x40	<b>GD07</b>

Size cm	Cod.
30x20	<b>GS08</b>
60x40	<b>GD08</b>

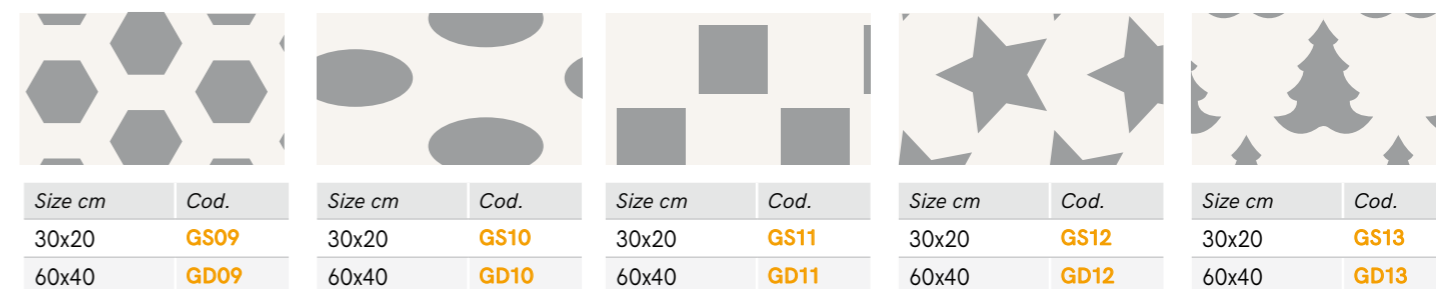

Size cm	Cod.
30x20	<b>GS09</b>
60x40	<b>GD09</b>

Size cm	Cod.
30x20	<b>GS10</b>
60x40	<b>GD10</b>

Size cm	Cod.
30x20	<b>GS11</b>
60x40	<b>GD11</b>

Size cm	Cod.
30x20	<b>GS12</b>
60x40	<b>GD12</b>

Size cm	Cod.
30x20	<b>GS13</b>
60x40	<b>GD13</b>

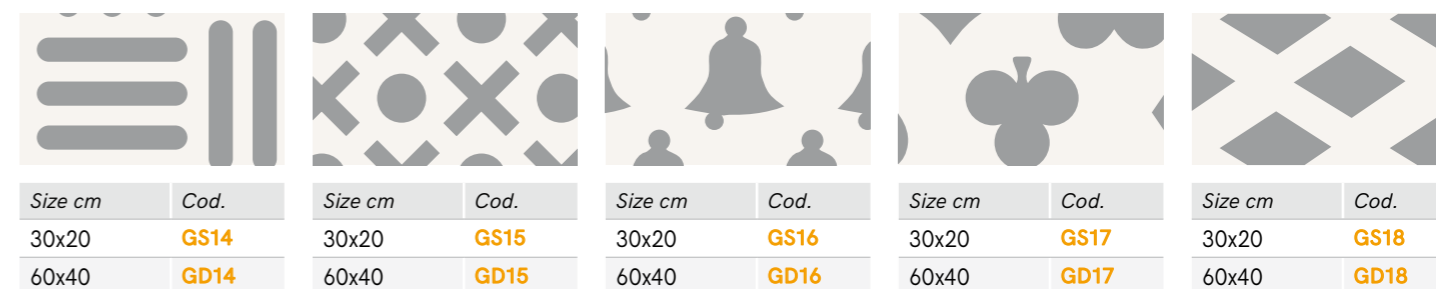

Size cm	Cod.
30x20	<b>GS14</b>
60x40	<b>GD14</b>

Size cm	Cod.
30x20	<b>GS15</b>
60x40	<b>GD15</b>

Size cm	Cod.
30x20	<b>GS16</b>
60x40	<b>GD16</b>

Size cm	Cod.
30x20	<b>GS17</b>
60x40	<b>GD17</b>

Size cm	Cod.
30x20	<b>GS18</b>
60x40	<b>GD18</b>

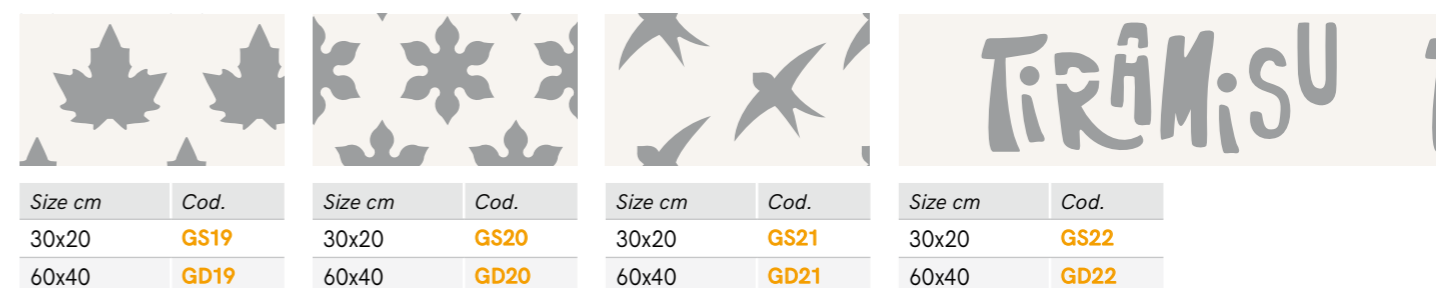

Size cm	Cod.
30x20	<b>GS19</b>
60x40	<b>GD19</b>

Size cm	Cod.
30x20	<b>GS20</b>
60x40	<b>GD20</b>

Size cm	Cod.
30x20	<b>GS21</b>
60x40	<b>GD21</b>

Size cm	Cod.
30x20	<b>GS22</b>
60x40	<b>GD22</b>



# TAPPETI DECORO DECORATIVE MATS

Tappeto in silicone per decori in rilievo.  
Relief silicone mats for baking.  
Size: 60 x 40 cm



**RELIEF1**  
Misura - Size: h 37mm



**RELIEF2**  
Misura - Size: Ø 4mm



**RELIEF3**  
Misura - Size: h 47mm



**RELIEF4**  
Misura - Size: h 30mm



**RELIEF5**  
Misura - Size: h 30mm



**RELIEF6**  
Misura - Size: h 30mm



**RELIEF7**  
Misura - Size: h 30mm



**RELIEF8**  
Misura - Size: h 30mm



**RELIEF9**  
Misura - Size: h 30mm



**RELIEF10**  
Misura - Size: h 30mm



**RELIEF11**  
Misura - Size: h 30mm



**RELIEF12**  
Misura - Size: h 30mm



# PETTINI DECORO DECORATIVE COMBS

Pettini in materiale plastico con doppio decoro ideali per biscuit e cioccolato  
Plastic combs with double decoration suitable for biscuit and chocolate



PD

PDM

PDS

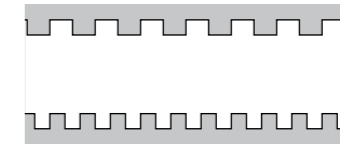

cm	Cod.
70	<b>PD1/2</b>
34	<b>PDM1/2</b>
17	<b>PDS1/2</b>

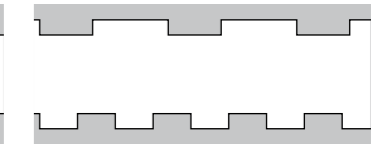

cm	Cod.
70	<b>PD3/4</b>
34	<b>PDM3/4</b>
17	<b>PDS3/4</b>

scale 1:1

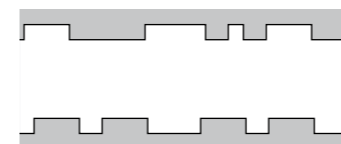

cm	Cod.
70	<b>PD5/6</b>
34	<b>PDM5/6</b>
17	<b>PDS5/6</b>

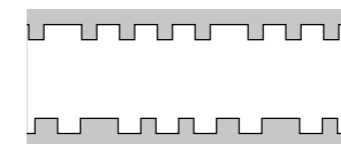

cm	Cod.
70	<b>PD7/8</b>
34	<b>PDM7/8</b>
17	<b>PDS7/8</b>

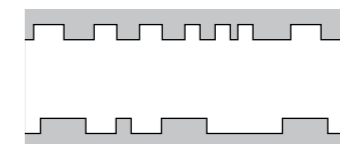

cm	Cod.
70	<b>PD9/10</b>
34	<b>PDM9/10</b>
17	<b>PDS9/10</b>

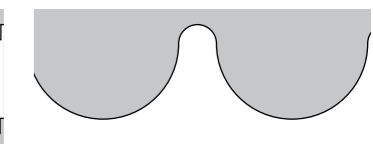

h cm	Cod.
70	<b>PD13/14</b>
34	<b>PDM13/14</b>
17	<b>PDS13/14</b>

scale 1:1

Pettini in materiale plastico per triplo decoro.  
Plastic combs for triple decoration.

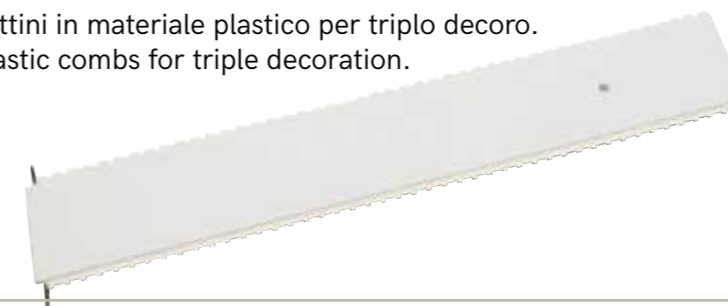

**Pettine 3 colori  
Comb 3 colours**  
**PD11/12**  
70cm

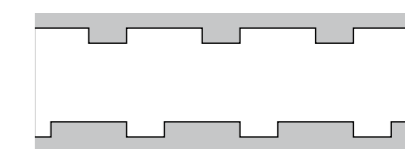

scale 1:1

## Tampone effetto legno - Wood comb

In polipropilene per decorazioni in cioccolato.  
Made of polypropylene. For chocolate decorations.

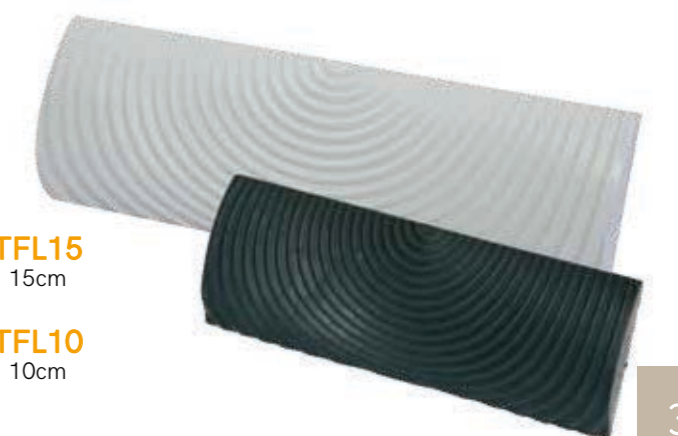

**TFL15**  
15cm

**TFL10**  
10cm



# COLORANTI ALIMENTARI FOOD COLOURANT

Martellato propone una linea completa di coloranti alimentari per dolci, in versione spray, in polvere o in gelatina, ideali per impreziosire e dare un tocco di fantasia a dolci, gelati e altri prodotti dolciari.

Martellato offers a full range of edible cake food colouring available in spray, powders or gel pastes ideal to decorate and add a splash of whimsy to cakes, ice-cream and other desserts.



## VELVET SPRAY

I coloranti alimentari spray Velvet, a base di burro di cacao, offrono al semifreddo un decoro dall'effetto vellutato. L'articolo può essere spruzzato su tutte le superfici congelate: semifreddi, mousse, torte gelato, cioccolato, creme etc

The Velvet food colouring spray, made with cocoa butter, offer a velvety decor for semifreddi. The product can be sprayed on all frozen surfaces: semifreddos, mousses, ice cream cakes, chocolate, creams, etc.

### DOVE USARLO

- semifreddi
- gelati
- mousse
- altre superfici congelate

### CREATED FOR

- semifreddos
- ice-creams
- mousses
- other frozen products



Color	ml	Code	info
Bianco - White	400	LCV000	Azo free
Arancione - Orange	400	LCV001	Azo
Azzurro - Sky blue	400	LCV003	Azo free
Giallo - Yellow	400	LCV004	Azo
Cioccolato al Latte - Milk choc.	400	LCV005N	Azo

Color	ml	Code	info
Fucsia - Fuchsia	400	LCV107	Azo
Rosso - Red	400	LCV008	Azo
Verde - Green	400	LCV009N	Azo
Cioccolato fondente - Dark choc.	400	LCV015N	Azo

### SPRAY VELVET - CONSIGLI D'USO:

Il prodotto su cui si spruzza il Velvet deve essere congelato. Mantenere il prodotto ad una temperatura di 20/25°C per almeno 2 ore e agitare bene prima dell'uso. Spruzzare uno strato sottile ed omogeneo di prodotto sulla superficie congelata che si vuole trattare da una distanza di circa 15/20 cm ad intervalli regolari. Ruotare costantemente il dolce mentre si spruzza la decorazione Velvet in modo da distribuire uniformemente il prodotto. Si consiglia di pulire l'erogatore con acqua calda subito dopo l'uso.

### VELVET SPRAY - DIRECTIONS FOR USE:

It is essential that the surface is frozen. Keep the product at 20/25°C for at least 2 hours. Shake well before use. Spray a thin, uniform layer on the product from a distance of about 15-20 cm at regular intervals. Constantly rotate the cake while decorating with Velvet to evenly distribute the product. It is advisable to clean the nozzle with hot water right after use.



## SPECIAL SPRAY

### MARZIPAN SHINY

**LCV100**  
Azo free 400 ml

Lucidante alimentare neutro a base di burro di cacao ideale per proteggere e lucidare marzipane e pasta di mandorle.

Neutral Food Polishing composed of cocoa butter, ideal to protect and polish marzipan and almond paste



### COOLER

**EUROCHOCK**  
Azo free 400 ml

Refrigerante in spray, con cannuccia unidirezionale, per la presa istantanea di particolari in cioccolato o zucchero.

Spray cooler, with monodirection straw, enables to fix chocolate and sugar pieces.



### COATING

**COATING**  
Azo free 400 ml

Staccante alimentare ideale per velocizzare la rimozione del prodotto da teglie o cinture in acciaio e alluminio, stampi semifreddo, termoformati o altro. Il prodotto è inodore e insapore.

Detaching ideal to remove easily the product from mould trays, steel belts, aluminium moulds, thermoformed moulds and other.

The product is odourless and tasteless.



### SHINY

**LCS200**  
Azo free 400 ml

Per la lucidatura e protezione di superfici a base di zucchero o cioccolato.

To protect and polish sugar-based products or chocolate.

### SHINY AIRBRUSH

**LCAS100**  
Azo free 100 gr



#### SPRAY SPECIALI - CONSIGLI D'USO:

Agitare la bomboletta e spruzzare uniformemente ad una distanza di circa 15-20 cm.

#### SPECIAL SPRAY - DIRECTIONS FOR USE:

Shake the can and spray evenly at a distance of about 15-20 cm

## HIDROALCOHOLIC SPRAY

Coloranti alimentari **idroalcolici** in bombolette spray.

Ideali per la colorazione di masse grasse, cioccolato, marzipane, biscotteria, cialde, zucchero tirato soffiato e colato, pasta di zucchero, semifreddi, mousse, gelato, pastigliaggio e pasticceria generale.

**Hydroalcoholic** food colouring in spray cans.

Ideal for the decoration of fat masses, chocolate, marzipan, biscuits, waffles, pulled sugar, candy floss, poured sugar, sugar paste, semifreddos, mousses, ice-cream, pastry in general.



#### DOVE USARLO

- masse grasse
- cioccolato
- marzipane
- biscotteria
- cialde
- zucchero tirato soffiato e colato
- pasta di zucchero
- semifreddi
- mousse
- gelato
- pastigliaggio
- pasticceria generale

#### CREATED FOR

- fat masses
- chocolate
- marzipan
- biscuits
- wafers
- pulled, blown and melted sugar
- sugar paste
- semifreddos
- mousse
- ice-creams
- pastillages
- general pastry

#### PEARL SPRAY COLOURING

Color	ml	Code	info
Bronzo - Bronze	100	<b>LCS215</b>	Azo free
Oro - Gold	100	<b>LCS217N</b>	Azo free
Rubino - Ruby	100	<b>LCS218N</b>	Azo free
Argento - Silver	100	<b>LCS219N</b>	Azo free
Rame - Copper	100	<b>LCS220</b>	Azo free

#### PASTEL SPRAY COLOURING

Color	ml	Code	info
Aranzone - Orange	100	<b>LCS001</b>	Azo
Azzurro - Sky blue	100	<b>LCS003</b>	Azo free
Giallo - Yellow	100	<b>LCS004</b>	Azo
Bruno - Brown	100	<b>LCS005</b>	Azo
Rosa - Pink	100	<b>LCS007</b>	Azo free
Rosso - Red	100	<b>LCS008</b>	Azo
Verde - Green	100	<b>LCS009</b>	Azo

#### SPRAY IDROALCOLICI - CONSIGLI D'USO:

Agitare il prodotto prima dell'uso, mantenersi ad una distanza di circa 15 cm.  
Non spruzzare in quantità eccessiva per non rischiare di causare macchie indesiderate.  
Lasciare asciugare per qualche secondo prima di spruzzare nuovamente sul prodotto da decorare.

#### HYDROALCOHOLIC SPRAY - DIRECTIONS FOR USE:

Shake the product before use, keep at a distance of about 15 cm. Do not spray too much in order to avoid unwanted stains. Allow to dry for a few seconds before spraying again on the product to be decorated.



# HIDROALCOHOLIC FOR AIRBRUSH

## SPECIAL FOR CHOCOLATE



Prodotto **idroalcolico** con capacità coprente, adatto in particolar modo alla colorazione del cioccolato e pasta zucchero.  
**Hydroalcoholic** product that can easily cover chocolate or sugar paste.

### DOVE USARLO

- masse grasse
- cioccolato
- marzapane
- biscotteria
- cialde
- pasta di zucchero
- pasta di mandorle
- glasse

### CREATED FOR

- fat masses
- chocolate
- marzipan
- biscuits
- wafers
- sugar paste
- almond paste
- icings

### SATIN COLOURING AIRBRUSH

Color	gr	Code	info
Bianco - White	60	LCA300	Azo free
Azzurro - Skyblue	60	LCA303	Azo free
Giallo - Yellow	60	LCA304	Azo free
Rosa - Pink	60	LCA307	Azo free
Rosso - Red	60	LCA308	Azo free
Verde - Green	60	LCA309	Azo free

Color	gr	Code	info
Arancio - Orange	40	40-WCA301	Azo free
Azzurro - Skyblue	40	40-WCA303	Azo free
Giallo - Yellow	40	40-WCA304	Azo free
Nero - Black	40	40-WCA306	Azo free
Rosso - Red	40	40-WCA308	Azo free
Verde lime - Lime green	40	40-WCA326	Azo free

### PEARL COLOURING AIRBRUSH

Color	gr	Code	info
Rosso - Red	100	LCA408	Azo free
Oro - Gold	100	LCA417	Azo free
Argento - Silver	100	LCA419	Azo free

Color	gr	Code	info
Oro - Gold	40	40-WCA417	Azo free
Argento - Silver	40	40-WCA419	Azo free

### IDROALCOLICI AEROGRAFO - CONSIGLI D'USO:

Agitare bene il flacone prima dell'uso e rimuovere i pigmenti che si depositano nel fondo con l'aiuto di un bastoncino. Se utilizzato con aerografo nebulizzare a circa 10 cm. Il prodotto può essere usato per colorare l'interno dello stampo, o direttamente sulla superficie di cioccolato a soggetto finito.

### AIRBRUSH HYDROALCOHOLIC - DIRECTIONS FOR USE:

Shake the bottle well before use and remove the pigments that are deposited in the bottom with the help of a stick. When used with the airbrush, keep 10 cm distance from the chocolate figure. It can be used directly on the mould or on the finished chocolate figure.

# WATER-SOLUBLE AIRBRUSH

Prodotto idrosolubile dato a qualsiasi tipo di impasto o alimento  
**Non è consigliato l'uso sul cioccolato o altre masse grasse.**  
 Water-soluble product suitable for any type of dough or food  
**It's not recommended for use on chocolate or other fat masses.**

### DOVE USARLO

- marzapane
- biscotteria
- cialde
- zucchero tirato soffiato e colato
- pasta di zucchero
- semifreddi
- mousse
- gelato
- pastigliaggio
- pasticceria generale
- glasse
- panna
- pasta frolla

### CREATED FOR

- marzipan
- biscuits
- wafers
- pulled, blown and melted sugar
- sugar paste
- semifreddo
- mousse
- ice-cream
- pastillages
- general pastry
- icings
- cream
- shortbread



### PEARL COLOURING AIRBRUSH

Color	ml	Code	info
Arancione - Orange	190	LCA201	Azo
Azzurro - Sky blue	190	LCA203	Azo free
Marrone - Brown	190	LCA205	Azo
Nero - Black	190	LCA206	Azo
Rosa - Pink	190	LCA207N	Azo
Rosso - Red	190	LCA208N	Azo
Verde - Green	190	LCA209	Azo
Viola - Violet	190	LCA210	Azo

Color	ml	Code	info
Limone - Lemon	190	LCA211	Azo
Pistacchio - Pistachio	190	LCA212	Azo
Oro - Gold	190	LCA217	Azo free
Argento - Silver	190	LCA219	Azo free

Color	gr	Code	info
Oro - Gold	45	40-WC617	Azo free
Argento - Silver	45	40-WC619	Azo free

### PASTEL COLOURING AIRBRUSH

Color	gr	Code	info
Bianco - White	45	40-WC600	Azo free
Arancione - Orange	45	40-WC601	Azo
Blu - Blue	45	40-WC602	Azo free
Azzurro - Sky blue	45	40-WC603	Azo free
Giallo - Yellow	45	40-WC604	Azo
Marrone - Brown	45	40-WC605	Azo
Nero - Black	45	40-WC606	Azo
Rosa - Pink	45	40-WC607	Azo
Rosso - Red	45	40-WC608	Azo
Verde - Green	45	40-WC609	Azo
Viola - Violet	45	40-WC610	Azo
Limone - Lemon	45	40-WC611	Azo
Pistacchio - Pistachio	45	40-WC612	Azo

Color	ml	Code	info
Bianco - White	190	LCA000	Azo free
Arancione - Orange	190	LCA001	Azo
Blu - Blue	190	LCA002	Azo free
Azzurro - Sky blue	190	LCA003	Azo free
Giallo - Yellow	190	LCA004	Azo
Marrone - Brown	190	LCA005	Azo
Nero - Black	190	LCA006	Azo
Rosa - Pink	190	LCA007N	Azo
Rosso - Red	190	LCA008N	Azo
Verde - Green	190	LCA009	Azo
Viola - Violet	190	LCA010	Azo
Limone - Lemon	190	LCA011	Azo
Pistacchio - Pistachio	190	LCA012	Azo



### IDROSOLUBILI AEROGRAFO - CONSIGLI D'USO:

Versare il colorante nel prodotto in base alla gradazione di colore che si vuole ottenere. In caso di utilizzo del colorante con aerografo si consiglia, a lavoro terminato, di lavare la penna con acqua calda, qualora rimanesse residuo di colore secco utilizzare alcool a 90°.

### AIRBRUSH WATER-SOLUBLE - DIRECTIONS FOR USE:

Pour the colouring in the product according to the shade of colour you want to obtain. In case of use of the colouring with an airbrush, it is recommended at the end of work to wash the pen with hot water. In case any residuals of colour remain, use alcohol at 90°.



## LIPOSOLUBLE POWDER



Il colorante alimentare in polvere **liposolubile e alcool solubile**, può essere usato per la decorazione di praline e soggetti di cioccolato, torte glassate, semifreddi, gelato, mousse, gelatina trasparente ecc.

The food **liposoluble** and **alcohol soluble** powder colouring can be used for decorating pralines or other figures of chocolate, frozen cakes, semifreddos, ice cream, mousse, transparent gelatin.

### DOVE USARLO

- cioccolato
- cioccolato bianco
- crema,
- pasta di zucchero
- pasta da modellaggio
- pasta di mandorle
- burro

### CREATED FOR

- chocolate
- white chocolate
- custard
- sugar paste
- modelling paste
- almond paste
- butter

### PEARLED POWDER COLOURING

Color	gr	Code	info
Blu - Blue	25	LCP003	Azo free
Rosso - Red	25	LCP008	Azo
Verde - Green	25	LCP009	Azo
Viola - Violet	25	LCP010	Azo
Bronzo - Bronze	25	LCP015	Azo free
Gold LUSTRE	25	LCP017N	Azo free
Rubino - Ruby	25	LCP018	Azo free
Silver LUSTRE	25	LCP019N	Azo free
Rame - Copper	25	LCP020	Azo free

Color	gr	Code	info
Fucsia - Fuchsia	25	LCP021	Azo
Oro - Gold	25	LCP117	Azo free
Argento - Silver	25	LCP119	Azo free

Color	gr	Code	info
Bronzo - Bronze	5	40-WC015	Azo free
Oro lustre - Gold	5	40-WC017	Azo free
Rame - Copper	5	40-WC020	Azo free
Argento - Silver	5	40-WC119	Azo free

### PASTEL POWDER COLOURING

Color	gr	Code	info
Bianco - White	5	40-WC300	Azo free
Blu - Blue	5	40-WC302	Azo free
Giallo - Yellow	5	40-WC304	Azo free
Marrone - Brown	5	40-WC305	Azo free
Nero - Black	5	40-WC306	Azo free
Rosa - Pink	5	40-WC307	Azo free
Rosso - Red	5	40-WC308	Azo free
Verde - Green	5	40-WC309	Azo free
Viola - Violet	5	40-WC310	Azo free
Arancione - Orange	5	40-WC311	Azo free
Candy pink	5	40-WC322	Azo free

Color	gr	Code	info
Bianco - White	25	LCP300	Azo free
Blu - Blue	25	LCP302	Azo free
Giallo - Yellow	25	LCP304	Azo
Marrone - Brown	20	LCP305	Azo
Nero - Black	25	LCP306	Azo free
Rosa - Pink	25	LCP307	Azo free
Corallo - Coral	25	LCP308	Azo
Rosso - Red	25	LCP308N	Azo
Verde - Green	25	LCP309	Azo
Arancione - Orange	25	LCP311	Azo

### POLVERE LIPOSOLUBILE - CONSIGLI D'USO:

Il colorante è solubile in alcool, operazione consigliata o in acqua operazione più faticosa. Grazie alla capacità di riflettere la luce dona alla decorazione un effetto metallizzato. Può essere usato direttamente sulla superficie di cioccolato, senza essere sciolto, con un pennello o con le dita ottenendo così un effetto perlato. Per la colorazione in superficie si può utilizzare la polvere mischiata alla gommalacca liquida, in modo che il prodotto aderisca bene alla superficie una volta decorata.

### LIPOSOLUBLE POWDER - DIRECTIONS FOR USE:

The colouring is soluble in alcohol (suggested operation) or in water (more difficult operation). Thanks to the ability to reflect the light, this powder gives the decoration a metallic effect. It can be used directly on the surface of chocolate, without being dissolved, with a brush or with fingers obtaining in this way a pearled effect to colour the surface you can use the powder mixed with the liquid shellac, so that the product adheres well to the surface once decorated.

## INTERFERENCE POWDER

Il colorante alimentare in polvere **liposolubile**, se associate ad una superficie scura, donano dei riflessi di luce colorata. Possono essere usate su soggetti di cioccolato fondente o paste zucchero colorate. The food colouring powders **liposoluble**, when applied on a dark surface, give some coloured light reflections. They can be used on dark chocolate figures or coloured sugar paste.

Color	gr	Code	info
Rossa - Red	5	40-WCP508	Azo free
Oro - Gold	5	40-WCP517	Azo free



## WATER-SOLUBLE POWDER



Colorante alimentare in polvere **idrosolubile** ad elevato grado di purezza, utilizzabile in qualsiasi tipo di impasto. High purity **water-soluble** food colouring powder to be used in any type of dough

### PASTEL POWDER COLOURING

Color	gr	Code	info
Blu - Blue	25	LCP202	Azo free
Giallo - Yellow	25	LCP204	Azo
Nero - Black	25	LCP206	Azo free
Rosso - Red	25	LCP208	Azo
Verde - Green	25	LCP209	Azo
Arancione - Orange	25	LCP211	Azo
Fragola - Strawberry	25	LCP218	Azo

### DOVE USARLO

- panna
- pasta di zucchero
- pasta da modellaggio
- semifreddi
- ghiaccia
- pastafrolla
- macarons
- meringhe

### CREATED FOR

- cream
- sugar paste
- modelling paste
- semifreddo
- icing
- shortbread
- macarons
- meringues

### POLVERE IDROSOLUBILE - CONSIGLI D'USO:

Il colorante può essere sciolto con l'aggiunta di acqua. La grana più fine facilita e velocizza lo scioglimento della polvere.

### IDROSOLUBLE POWDER - DIRECTIONS FOR USE:

The colouring can be dissolved with the addition of water. The finer is the grain the faster is the dissolution of the powder.



## PUMP POWDER

Polvere perlescente con pompetta ad aria ideale per decorare prodotti finiti come torte, semifreddi e cioccolato.  
Pearlescent powder coat with air pump ideal for decorating finished products like cakes, semifreddi and chocolate.



Color	gr	Code	info
Rosso - Red	6	<b>LCP508</b>	Azo
Rosa - Pink	10	<b>LCP507</b>	Azo
Blu - Blue	10	<b>LCP502</b>	Azo free
Oro - Gold	10	<b>LCP517</b>	Azo
Argento - Silver	10	<b>LCP519</b>	Azo free

## GEL COLOURING



Colorante in gel ad altissima concentrazione, speciale per le colorazioni di pasta zucchero, masse grasse e royal ice.  
Highly concentrated colouring in gel to colour of sugar paste, fat masses and royal icing.

Color	gr	Code	info
Arancione - Orange	30	<b>LCG001</b>	Azo
Blu - Blue	30	<b>LCG002</b>	Azo free
Giallo - Yellow	30	<b>LCG004</b>	Azo
Marrone - Brown	30	<b>LCG005</b>	Azo
Nero - Black	30	<b>LCG006</b>	Azo
Rosa - Pink	30	<b>LCG007</b>	Azo

Color	gr	Code	info
Rosso - Red	30	<b>LCG008</b>	Azo
Verde - Green	30	<b>LCG009</b>	Azo
Viola - Violet	30	<b>LCG010</b>	Azo
Blue Navy	30	<b>LCG022</b>	Azo
Incarnato - Incarnate	30	<b>LCG025</b>	Azo

## JELLIES



La gelatina ad uso alimentare è ideale per guarnire le torte e dare un effetto di lucentezza.  
Food jellies are ideal to garnish every kind of cake.

**LCJ000**  
Transparent  
1000 gr  
Azo Free

**LCJ100**  
Glitter - Glitter  
Transparent  
1000 gr  
Azo Free

### GELATINE - CONSIGLI D'USO:

Una volta ammorbidita con la frusta, la gelatina va stesa sulla superficie della torta per dare un effetto lucido e glassato.

### JELLIES - DIRECTIONS FOR USE:

Soften the jelly with a whisk, and then spread it onto the cake surface to produce a shiny effect.

## COCOA BUTTER



I coloranti a base di burro di cacao, una volta sciolti a bagnomaria o microonde, risultano perfetti per la colorazione di prodotti di cioccolato e altre masse grasse.

Colourings made of cocoa butter, once melted in bain-marie or microwave, are perfect to colour chocolate products.

### DOVE USARLO

- cioccolato
- masse grasse

### CREATED FOR

- chocolate
- fat masses

Color	gr	Code	info
Bianco - White	200	<b>LCB200</b>	Azo free
Arancio - Orange	200	<b>LCB201</b>	Azo
Blu - Blue	200	<b>LCB202</b>	Azo free
Giallo - Yellow	200	<b>LCB204</b>	Azo
Nero - Black	200	<b>LCB206</b>	Azo
Rosso - Red	200	<b>LCB208</b>	Azo
Verde - Green	200	<b>LCB209</b>	Azo
Viola - Violet	200	<b>LCB210</b>	Azo

Color	gr	Code	info
Bianco - White	30	<b>40-WCB200</b>	Azo free
Arancio - Orange	30	<b>40-WCB201</b>	Azo
Blu - Blue	30	<b>40-WCB202</b>	Azo free
Giallo - Yellow	30	<b>40-WCB204</b>	Azo
Nero - Black	30	<b>40-WCB206</b>	Azo
Rosso - Red	30	<b>40-WCB208</b>	Azo
Viola - Violet	30	<b>40-WCB210</b>	Azo
Oro - Gold	30	<b>40-WCB217</b>	Azo free

### BURRO CACAO - CONSIGLI D'USO:

Il burro di cacao può essere utilizzato puro per piccole decorazioni con il pennello oppure, se diluito con 50% di cioccolato bianco, può essere spruzzato con pistola a caldo producendo così un effetto vellutato. Spruzzato all'interno di stampi per praline o corpi cavi, sciolto a 30°C oltre a colorare, permette di ottenere un effetto maculato, neve, goccia o buccia d'arancia.

### COCOA BUTTER - DIRECTIONS FOR USE:

The product when sprayed with hot gun, mixed with 50% of white chocolate, produces a velvety effect. Sprayed into moulds for chocolates, melted at 30°C, in addition to colour, allows to get spotted, snow, drop or orange peel effect.





## HORECA

MONOUSO/DISPOSABLE	314
PLEXIGLASS DISPLAY	328
ALZATE TORTE/ CAKE STANDS	340
MULTI-ICE	354



# MONOUSO & TAKE AWAY

Design e qualità contraddistinguono gli eleganti ed infrangibili articoli monouso ideali per ogni professionista del settore HORECA, della pasticceria e gelateria.

Design and quality characterize the elegant and unbreakable disposable items ideals for HORECA professionalist, pastry chef and ice cream maker



**PENTA**  
CAP. 120 ML  
Ø72 h56 mm  
**PMOPE001**  
**PMOPE0012200**  
Pack 22 pcs

**WAFLE**  
CAP. 70 ML  
64x62 h 59mm  
**PMOCO013**  
**PMOCO0132000**  
Pack 20 pcs

**SOFT ICE**  
CAP. 105 ML  
Ø70 h 59mm  
**PMOCO014**  
**PMOCO0143000**  
Pack 30 pcs  
**Coperchi - Lids**  
**PMOCO002/C**



**GREEK**  
CAP. 120ML  
Ø73 h 61mm  
**PMOCO009**  
**PMOCO0093000**  
Pack 30 pcs

**CAP. 190ML**  
Ø92 h 75mm  
**PMOCO010**  
**PMOCO0102000**  
Pack 20 pcs

**CAP. 50ML**  
Ø50 h 57mm  
**PMOCO008**  
**PMOCO0081800**  
Pack 18 pcs

Dove non espressamente indicato le confezioni si intendono da 100 pezzi  
If not indicated, the package contains 100 pieces





## CUBÒ

CAP. 58 ML  
50x50 h55 mm

**PMOCU004**

**PMOCU0041400**  
Pack 14 pcs



**Coperchi - Lids**  
**PMOCU002/C**



## WAVE

CAP. 200 ML  
100x70 h 82mm

**PMOCE003**  
**PMOCE0031000**  
Pack 10 pcs

CAP. 120 ML  
85x60 h70 mm

**PMOCE002**  
**PMOCE0021200**  
Pack 12 pcs

CAP. 50 ML  
64x46 h53 mm

**PMOCE001**  
**PMOCE0011800**  
Pack 18 pcs



## SQUARE

CAP. 60 ML  
40x40 h55 mm

**PMOCU001**  
**PMOCU0012800**  
Pack 28 pcs



**Coperchi - Lids**  
**PMOCU001/C**

CAP. 120 ML  
50x50 h70 mm

**PMOCU002**  
**PMOCU0021200**  
Pack 12 pcs



**Coperchi - Lids**  
**PMOCU002/C**

CAP. 175 ML  
55x55 h80 mm

**PMOCU003**  
**PMOCU0031000**  
Pack 10 pcs



**Coperchi - Lids**  
**PMOCU003/C**



## VELA

CAP. 200 ML  
90x83 h 74mm

**PMOCO015**  
**PMOCO0151800**  
Pack 18 pcs

CAP. 140 ML  
73x81 h 67mm

**PMOCO012**  
**PMOCO0121800**  
Pack 18 pcs

CAP. 85 ML  
63x69 h 57mm

**PMOCO011**  
**PMOCO0112000**  
Pack 20 pcs





### CYLINDER

CAP. 190 ML  
 Ø75 h85 mm  
**PMOCO007**  
**PMOCO0072000**  
 Pack 20 pcs

### BUBBLE

CAP. 215 ML  
 Ø90 h75 mm  
**PMOCO004**  
**PMOCO0042500**  
 Pack 25 pcs

### CONE

CAP. 165 ML  
 Ø90 h75 mm  
**PMOCO005**  
**PMOCO0052000**  
 Pack 20 pcs

### DROP

CAP. 190 ML  
 Ø75 h85 mm  
**PMOCO006**  
**PMOCO0062000**  
 Pack 20 pcs



### HEART

CAP. 100 ML  
 73x64 h52 mm  
**PMOLO001**

**PMOLO0011800**  
 Pack 18 pcs



**Coperchi - Lids**  
**PMOLO001/C**



### BUCKET

CAP. 210 ML  
 Ø78 h 57mm  
**PMOTO005**  
**PMOTO0051200**  
 Pack 12 pcs



**Coperchi - Lids**  
**PMOTO005/C**

### TUBE

CAP. 80 ML  
 Ø40 h85 mm  
**PMO08.00**  
**PMO08.01**  
**PMO08.02**

**PMO081800**  
 Pack 18 pcs

### TRIANGLE

CAP. 175 ML  
 Ø85 h65 mm  
**PMO07.00**  
**PMO07.01**  
**PMO07.02**

**PMO071800**  
 Pack 18 pcs



**Coperchi - Lids**  
**PMO07/C** transparent

### CLASSIC

CAP. 65 ML  
 Ø42 h65 mm  
**PMOTO001**  
**PMOTO0012000**  
 Pack 20 pcs



**Coperchi - Lids**  
**PMOTO002/C**

CAP. 90 ML  
 Ø50 h65 mm  
**PMOTO002**  
**PMOTO0021500**  
 Pack 15 pcs

CAP. 120 ML  
 Ø55 h70 mm  
**PMOTO003**  
**PMOTO0031000**  
 Pack 10 pcs

CAP. 170 ML  
 Ø60 h90 mm  
**PMOTO004**  
**PMOTO0041200**  
 Pack 12 pcs







## JAPAN

CAP. 47 ML  
Ø42 h43 mm

**PMOJA001**

**PMOJA0011600**

Pack 16 pcs

CAP. 87 ML  
Ø50 h54 mm

**PMOJA002**

**PMOJA0021500**

Pack 15 pcs



**Coperchi - Lids**  
**PMOTO002/C**



## CUP

CAP. 90 ML  
Ø65 h55 mm

**PMOCO001**

**PMOCO0013000**

Pack 30 pcs

**Coperchi - Lids**  
**PMOCO001/C**

CAP. 135 ML  
Ø70 h67 mm

**PMOCO002**

**PMOCO0022500**

Pack 25 pcs

**Coperchi - Lids**  
**PMOCO002/C**

CAP. 150 ML  
Ø75 h73 mm

**PMOCO003**

**PMOCO0032000**

Pack 20 pcs

**Coperchi - Lids**  
**PMOCO003/C**

## BOWL



CAP. 460 ML  
100x118 h70 mm

Cod. **ZENBO00** 50 pcs

Cod. **ZENBO01**

Cod. **ZENBO02**

## PLATE - LID

**Piatto - Coperchio**



100x118 h6 mm

Cod. **ZENBO00C** 50 pcs

## PLATE - TRAY

**Piatto - Vassoio**



110x245 h18 mm

50 pcs  Cod. **ZENTR00**  Cod. **ZENTR01**  Cod. **ZENTR02**





CAP. 50 ML  
75x75 h30 mm

## MINI BLOW

75 MM

## FINGER



100 pcs  
 Cod. **PMO11.00**  
 Cod. **PMO11.01**  
 Cod. **PMO11.02**  
 Cod. **PMO111500**  
 Pack 15 pcs



250 pcs  
 Cod. **FW006.00**  
 Cod. **FW006.01**  
 Cod. **FW006.02**  
 Cod. **FW0062400**  
 Pack 24 pcs

CAP. 20 ML  
90x90 h15 mm

## TRIANGLE

75 MM

## FINGER 3



100 pcs  
 Cod. **PMO09.00**  
 Cod. **PMO09.01**  
 Cod. **PMO09.02**  
 Cod. **PMO092000**  
 Pack 20 pcs



250 pcs  
 Cod. **FW005.00**  
 Cod. **FW005.01**  
 Cod. **FW005.02**  
 Cod. **FW0052400**  
 Pack 24 pcs

CAP. 30 ML  
85x85 h30 mm

## BLOW

85 MM

## MINI FORK



100 pcs  
 Cod. **PMO10.00**  
 Cod. **PMO10.01**  
 Cod. **PMO10.02**  
 Cod. **PMO101000**  
 Pack 10 pcs



500 pcs  
 Cod. **FW001.00**  
 Cod. **FW001.01**  
 Cod. **FW001.02**  
 Cod. **FW0011000**  
 Pack 100 pcs

CAP. 11 ML  
105x50 h30 mm

## WING

85 MM

## MINI SPOON



100 pcs  
 Cod. **PMO12.00**  
 Cod. **PMO12.01**  
 Cod. **PMO12.02**  
 Cod. **PMO122000**  
 Pack 20 pcs



500 pcs  
 Cod. **FW002.00**  
 Cod. **FW002.01**  
 Cod. **FW002.02**  
 Cod. **FW0021000**  
 Pack 100 pcs



# SMALL PLATE



CAP. 15 ML  
65x65 h15 mm



## SINGLE

- 100 pcs Cod. **PMO13.00**  
 Cod. **PMO135000**  
 Pack 50 pcs
- Cod. **PMO13.01**
- Cod. **PMO13.02**

CAP. 20 ML  
110x65 h20 mm



## DOUBLE

- 100 pcs Cod. **PMO14.00**  
 Cod. **PMO142000**  
 Pack 20 pcs
- Cod. **PMO14.01**
- Cod. **PMO14.02**

CAP. 30 ML  
115x105 h15 mm



## TRIPLE

- 100 pcs Cod. **PMO15.00**  
 Cod. **PMO152500**  
 Pack 25 pcs
- Cod. **PMO15.01**
- Cod. **PMO15.02**

## TONDO

85x96 h20 mm



- 100 pcs Cod. **PL00100**
- Cod. **PL00101**
- Cod. **PL00102**

## QUADRO

80x97 h20 mm



- 100 pcs Cod. **PL00200**
- Cod. **PL00201**
- Cod. **PL00202**

## SKEWERS

90 MM

- 500 pcs **FW003**
- 

120 MM

- 500 pcs **FW004**
-





CAP. 70 ML  
Ø65x h36 mm

CAP. 120 ML  
Ø76x h43 mm

CAP. 120 ML  
Ø67,5x h58 mm

CAP. 120 ML  
Ø72x h51 mm

CAP. 120 ML  
Ø75,5x h35 mm



**PMOVA001.00**  
Pack 100 pcs



**PMOVA002.00**  
Pack 100 pcs



**PMOVA003.00**  
Pack 100 pcs

Pack 100 pcs

Pack 12 pcs

Pack 100 pcs

Pack 12 pcs

Color	Code
Transparent	60P00100
Giallo - Yellow	60P00111
Verde - Green	60P00109
Sky blue	60P00102
Rosa - Pink	60P00107
Fucsia - Fuchsia	60P00121
Rosso - Red	60P00108

Color	Code
Transparent	60P00100/12
Giallo - Yellow	60P00111/12
Verde - Green	60P00109/12
Sky blue	60P00102/12
Rosa - Pink	60P00107/12
Fucsia - Fuchsia	60P00121/12
Rosso - Red	60P00108/12

Color	Code
Transparent	60P00200
Giallo - Yellow	60P00211
Verde - Green	60P00209
Sky blue	60P00202
Rosa - Pink	60P00207
Fucsia - Fuchsia	60P00221
Rosso - Red	60P00208

Color	Code
Transparent	60P00200/12
Giallo - Yellow	60P00211/12
Verde - Green	60P00209/12
Sky blue	60P00202/12
Rosa - Pink	60P00207/12
Fucsia - Fuchsia	60P00221/12
Rosso - Red	60P00208/12

## DISPOSABLE FLÛTE

Bicchieri in plastica trasparente  
con base predisposta per incastro a piramide.  
Transparent plastic flûte with base arranged for pyramid joint.



**PMOVA001**  
Pack 100 pcs



**PMOVA002**  
Pack 100 pcs



**PMOVA003**  
Pack 100 pcs

**FLU01**  
Ø56x h170 mm  
Cap. 120 ml  
Pack 100 pcs





# PLEXIGLASS DISPLAY



## COD33201

Misura - Size:  
38x53,3 h 71 cm  
Piatti - Plate:  
(2) 33x26 cm  
(2) 29x22 cm



## COD33301

Misura - Size:  
34x34 h37,5 cm  
Piatti - Plate:  
Ø34 - Ø26 - Ø15,5 cm  
Distanza tra ripiani 11 cm  
Distance between shelves 11 cm



## COD60501

Misura - Size:  
h41 cm  
Piatti - Plate:  
49x49 - 39x39  
29x29 - 19x19 cm  
Distanza tra ripiani 12 cm  
Distance between shelves 12 cm



## COD. 603

Misura - Size:  
h 58 cm  
Piatti - Plate:  
Ø 50 - 42 - 34  
Ø 26 - 18 cm



## COD. 312

Misura - Size:  
h 72 cm  
Piatti - Plate:  
65x57 - 42x48  
34x39 - 25x29 cm



## COD33401

Misura - Size:  
42x42 h 30,5 cm  
Piatti - Plate:  
Ø42 - Ø37 - Ø25 cm  
Distanza tra ripiani 12 cm







**COD33501**

Display in plexiglass satinato e bianco  
 Transparent and glaze plexiglass display  
 Misura - Size: h 50,5 cm  
 Piatti - Plate:  
 63,5 x35 - 52,5 x 25,5 - 43x21,5 - 35x19 - 28x14,5 cm  
 Distanza tra ripiani 12 cm  
 Distance between shelves 12 cm



**COD35101**

Misura - Size: h38 cm  
 Piatti - Plate: 50x50 h.12 - 36x36 h.12 - 22,5x22,5 h. 12 cm



**COD. 33001**

Misura - Size: 64x64 - h 33 cm  
 Piatti - Plate: 64x64 - 44x44 - 26 x26 cm



**COD. 510**

Misura - Size:  
 41x41 - h 67 cm  
 Piatti - Plates:  
 40x40 - 35x35 cm  
 30x30 - 20x20 cm



**COD. 511**

Misura - Size:  
 41x41 - h 67 cm  
 Piatti - Plates:  
 40x40 - 35x35 cm  
 30x30 - 20x20 cm



**COD. 305**

Misura - Size:  
 Ø 28 h29 - 38x30 h21  
 38x30 h13 - 38x30 h5 cm



**COD. 307**

Misura - Size:  
 40x27 h29 - 40x27h 21  
 40x27 h13 - 40x27 h5 cm





**COD. 32901**  
 Misura - Size:  
 35x55,5 h27 cm  
 Piatti - Plate: 35x25 - 30x12 - 28x18 cm

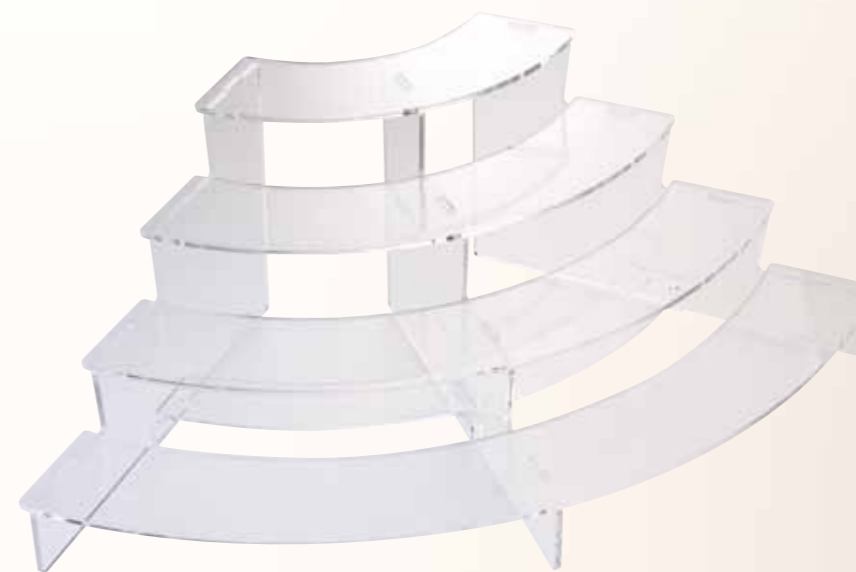

**COD. 320**  
 Misura - Size: h 22,5 cm  
 Piatti - Plate: 65x35,5 cm

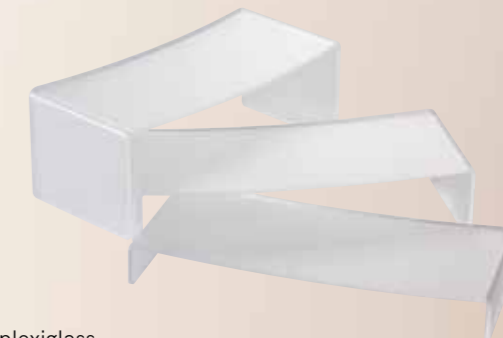

**COD33906**  
 Satinato - Glazed plexiglass  
 Piatti - Plate: 35,5x17 h22 - 57x17 h9 - 40x17 h5 cm



**COD33701**  
 Piatti - Plate:  
 50x20 h20,5 - 50x20 h14 - 50x20 h7 cm



**COD. 310**  
 Misura - Size:  
 40x20 h12 - 40x18 h8 - 40x16 h4 cm



**COD34001**  
 Piatti - Plate:  
 49x15,5 h18 - 49x15,5 h13 - 49x15,5 h8 cm



**COD. 309**  
 Misura - Size: h 4 - 11 - 18 - 25 cm  
 Piatti - Plate: 24,5x24,5 cm





**COD. 500**  
Misura - Size:  
h 50 cm  
Piatti - Plate:  
33x33  
28x28  
22x22 cm



**COD. 501**  
Misura - Size:  
h 50 cm  
Piatti - Plate:  
Ø40  
Ø32  
Ø26 cm

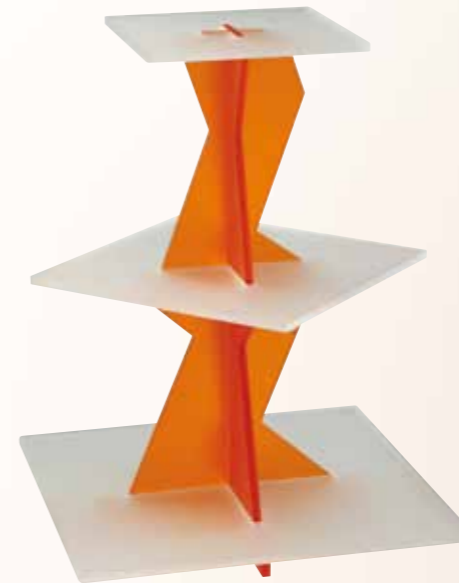

**COD. 308**  
Misura - Size:  
40x40 - h 53 cm  
Piatti - Plate:  
40x40 - 30x30 -  
22x22 cm

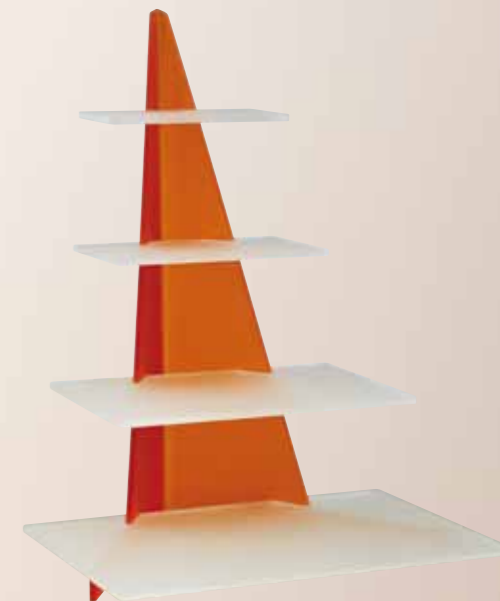

**COD. 300**  
Misura - Size:  
54x47 - h 63 cm  
Piatti - Plate:  
47x34 - 37x25 -  
27x17 - 23x13 cm



**COD. 503**  
Misura - Size:  
h 50 cm  
Piatti - Plate:  
36x55  
25x50  
22x45 cm



**COD. 301**  
Misura - Size:  
70x40 - h 62 cm  
Piatti - Plate:  
70x40 - 63x35  
52x26 - 42x21 cm



**COD. 322**  
Misura - Size:  
h 49,5 cm  
Piatti - Plate:  
Ø40,5 - 39 - 38  
35,5 - 31,5 cm



**COD. 302**  
Misura - Size:  
Ø 39 - h 62 cm  
Piatti - Plate:  
Ø 39 - Ø 31  
Ø 25 - Ø 19 cm



**COD. 32418**  
Rosa - pink

**COD. 32416**  
Marrone - Brown

Misura - Size:  
45x30 h61 cm  
Piatti - Plate:  
32x24 (x3) cm



**COD. 32518**  
Misura - Size: 23x45 - h 74 cm  
Piatti - Plate: Ø20 - Ø28 - Ø36 - Ø45 cm



Misura - Size:  
h 3,6 - 11 - 17,6 - 25 cm  
Piatti - Plate:  
24,5x24,5 cm

**COD. 33118**  
Rosa - pink

**COD. 33101**  
trasparente - transparent





**COD30400**  
Bianca - White

**COD30408**  
Nero - Black

**COD. 304**  
Verde - Green

Misura - Size:  
56 - h 62 cm  
Piatti - Plate:  
Ø 56 - Ø 46  
Ø 33 - Ø 22 cm



**COD. 32717**  
Lilla - Lilac

**COD. 32715**  
Blu - Blue

Misura - Size:  
52x43,5 - h 62 cm  
Piatti - Plate:  
34x18 - 43x23  
46,5x25,5  
42,5x23,5 cm



**COD. 316**  
Misura - Size: 33x33 - h 54,5 cm  
Piatti - Plate: 33x33 cm



**COD. 32816**  
Misura - Size: 53x46,5 h 57,5 cm  
Piatti - Plate: Ø29 - Ø35 - Ø38 - Ø39 cm





**COD32108**  
Nero - Black  
Misura - Size:  
56x35 - h 59 cm



**COD32100**  
Bianco - White  
Misura - Size:  
56x35 - h 59 cm



**COD. 32508**  
Misura - Size:  
23x45 - h 74 cm  
Piatti - Plate:  
Ø20 - Ø28  
Ø36 - Ø45 cm



**COD. 321**  
Arancione - Orange  
Misura - Size:  
56x35 - h 59 cm



**COD33608**  
Misura - Size:  
65x35 h 27 cm  
Piatti - Plate: 37x26 - 30x22 - 22x16 cm

**COD. 303**  
Misura - Size: 60x50 - h 60 cm  
Piatti - Plate: 60x43 - 49x35 - 27x37 - 25x18





# CAKE STANDS



## ELEGANT

Piatti - Plates:  
 Ø 18 - Ø 22 - Ø 24 - Ø 28 - Ø 32 - Ø 36 cm  
 Porz. - Portions: 70 - 80



**COD. 113/A**  
 Misura - Size:  
 h 110 cm

## LIBERTY

Piatti - Plates:  
 Ø 15 - Ø 30 - Ø 50 cm



**COD. 509**  
 Misura - Size: h 75 cm

Unendo le alzate: Cod. 507 (senza i piedini) con Cod. 508 si ottiene Cod. 509  
 Combining the cake stands: Cod. 507 (no feet) with Cod. 508 you get Cod. 509



**COD. 507**  
 Misura - Size: h 41 cm



**COD. 508**  
 Misura - Size: h 41 cm

## LIGHT SQUARE

Piatti - Plates:  
 25 x 25 - 30 x 30 cm  
 35 x 35 - 40 x 40 cm  
 Porz. - Portions: 80 - 85



**COD. 130**  
 Misura - Size: h 80 cm

## LIGHT ROUND

Piatti - Plates:  
 Ø 24 - Ø 29 - Ø 34 - Ø 39 cm  
 Porz. - Portions: 40 - 50



**COD. 131**  
 Misura - Size: h 80 cm

## LIGHT HEART

Piatti - Plates:  
 25 x 21 - 30 x 26 - 35 x 30 - 40 x 34 cm  
 Porz. - Portions: 40 - 50



**COD. 132**  
 Misura - Size: h 80 cm





## ROMANTIC

Piatti - Plates:  
 Ø 20 - 22 - 26 - 28 - 30 cm

**COD. 504**  
 Misura - Size: h 125 cm  
 Piatti in plexiglass satinato  
 Glazed plexiglass plate

## CARRÈ

Piatti - Plates:  
 25 x 25 - 30 x 30 - 35 x 35  
 40 x 40 - 45 x 45 cm  
 Porz. - Portions: 145 - 155



**COD. 102**  
 Misura - Size: h 96 cm



**COD. 101**  
 Misura - Size: h 120 cm  
 FONTANINA non inclusa - not included

## FOUNTAIN

Piatti - Plates:  
 Ø 25 - 48 - 85 cm  
 Porz. - Portions: 90 - 100



**COD. 111**  
 Misura - Size: h 100 cm  
 FONTANINA non inclusa - not included

## CIRCLE

Piatti - Plates:  
 Ø 25 - 30 - 35 - 40 - 48 cm  
 Porz. - Portions: 100 - 110



**COD. 104**  
 Misura - Size: h 86 cm



**COD. 103**  
 Misura - Size: h 120 cm  
 FONTANINA non inclusa - not included

## ACCESSORIES



Small column  
**COLONNINA**  
 13 cm

Big column  
**COLONNA**  
 35 cm



Electric fountain  
**FONTANINA - 12V**  
 Misura - Size: Ø38 - h 40 cm



# MODULAR DISPLAY



## 4 PLATES

Piatti - Plate:  
20 - 26 - 32 - 38 cm

**COD513**  
Misura - Size:  
70x65 h56 cm



## 3 PLATES

Piatti - Plate:  
20 - 26 - 32 cm

**COD512**  
Misura - Size:  
67x37 h21 cm



## 5 PLATES

Piatti - Plate:  
20 - 26 - 32 cm

**COD514**  
Misura - Size:  
100x53 h39,5 cm

## ALZATE COMPONENTIBILI

Combinando tra loro le alzate si possono avere le composizioni più adatte alle proprie necessità  
Combining the models you will have the desired compositions

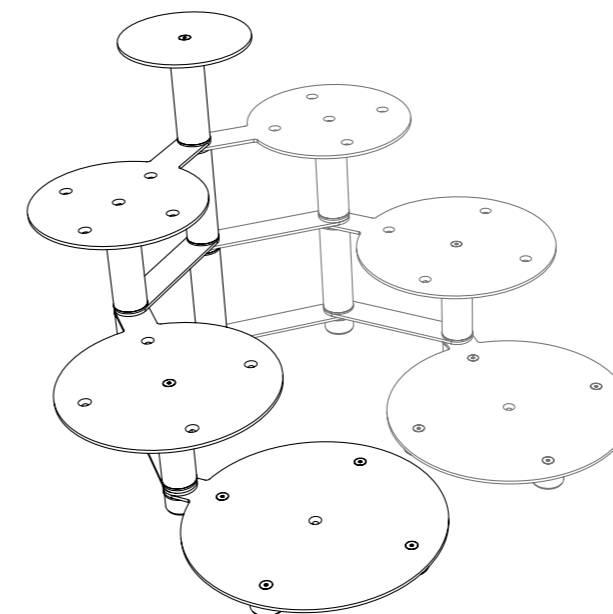

COD513 + COD513

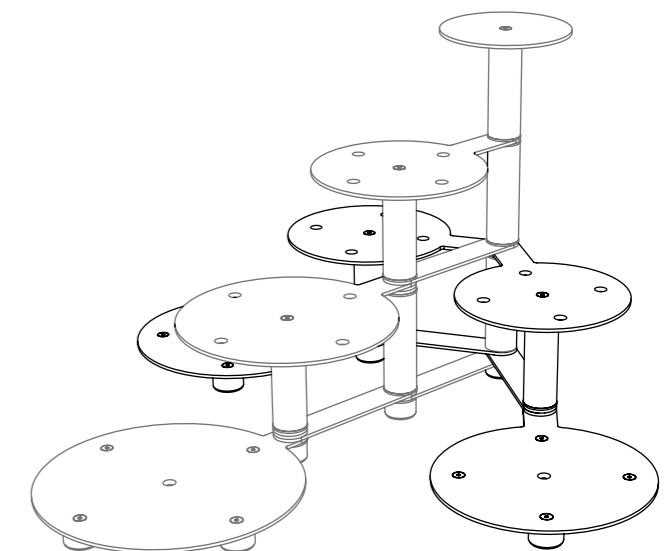

COD513 + COD514



## GRADUS

Porz. - Portions: 45 - 55



**COD. 190**

Misura - Size: 88 x 30 h 34 cm

## MEMPHIS

Porz. - Portions: 50 - 60



**COD. 183**

Misura - Size: Ø 70 h 50 cm

## MANHATTAN

Piatti - Plates:  
6 x Ø 26 - 1 x Ø 38 cm  
Porz. - Portions: 100 - 110



**COD. 159**

Misura - Size: Ø 65 h 85 cm

## MILANO

Piatti - Plates:  
4 x Ø 20 - 1 x Ø 25 cm  
Porz. - Portions: 30 - 35



**COD. 192**

Misura - Size: 62 x 62 h 38 cm

## STAIRWAY

Piatti - Plates:  
23x18 - 29x17 - 39x19 - 50x22 - 60x25 cm  
Porz. - Portions: 75 - 85

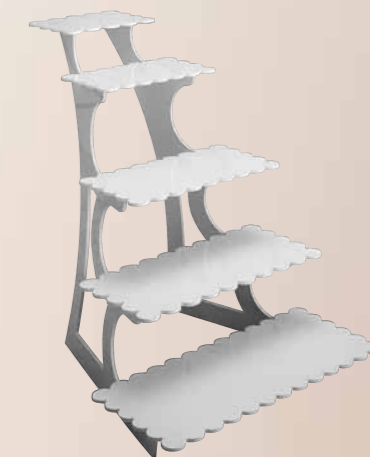

**COD. 150**

Misura - Size: h 80 cm

## CLOVER

Piatti - Plates:  
3 x Ø 28 - 3 x Ø 20 - 1 x Ø 22 cm  
Porz. - Portions: 40 - 45



**COD. 188**

Misura - Size: 65x62 h 38 cm

## DAISY

Piatti - Plates:  
6 x Ø 28 - 1 x Ø 48 - 1 x Ø 30 cm  
Porz. - Portions: 120 - 130



**COD. 180**

Misura - Size: Ø 90 h 45 cm

## BABY CARRIAGE

Piatti - Plates: 50 x 30 cm  
Porz. - Portions: 25 - 30



**COD. 187**

Misura - Size: 70x35 h 62 cm

## BABY COT

Piatti - Plates: 55 x 50 cm  
Porz. - Portions: 25 - 30

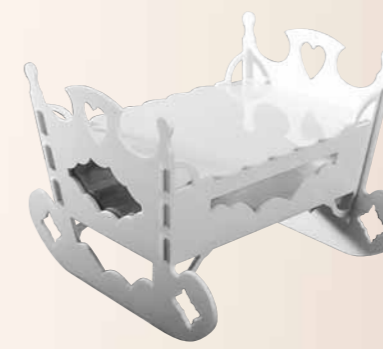

**COD. 117**

Misura - Size: h 38 cm

## PARIS

Piatti - Plates:  
62 x 62 - 41 x 41 - 31 x 31 - 19 x 19 cm  
Porz. - Portions: 85 - 95

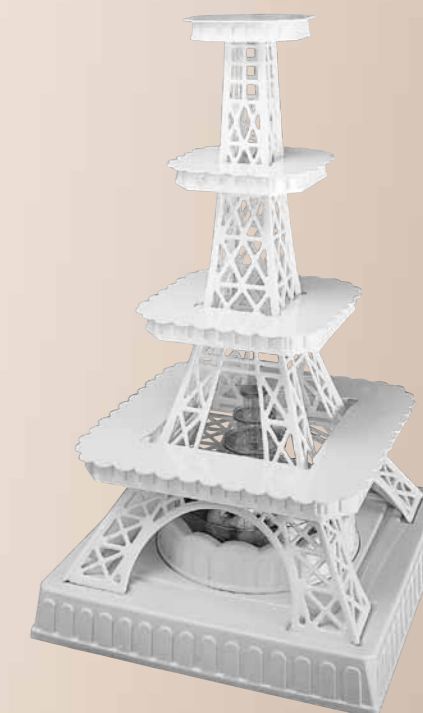

**COD. 127**

Misura - Size: 73 x 73 h 140 cm  
FONTANINA non inclusa - not included  
Base with separator ring included

## ROMANTICA

Piatti - Plates:  
5 x Ø 26 - 5 x Ø 20 - 1 x Ø 34 cm  
Porz. - Portions: 100 - 110



**COD. 152**

Misura - Size: Ø 80 h 70 cm

## SEMIRAMIDE

Piatti - Plates:  
3 x Ø 32 - 3 x Ø 26 - 1 x Ø 38 cm  
Porz. - Portions: 90 - 100



**COD. 153**

Misura - Size: 100 x 54 h 88 cm

## BASE

Piatti - Plates: Ø 85 cm  
Porz. - Portions: 85 - 95

**COD. 118**

Misura - Size: h 23 cm



Base abbinabile a molte alzate - Base that can be combined with many cakestands



# FLORA

Piatti - Plates:  
4x Ø 34 - 7 x Ø 26 - 1 x Ø 32 cm  
Porz. - Portions: 145 - 155

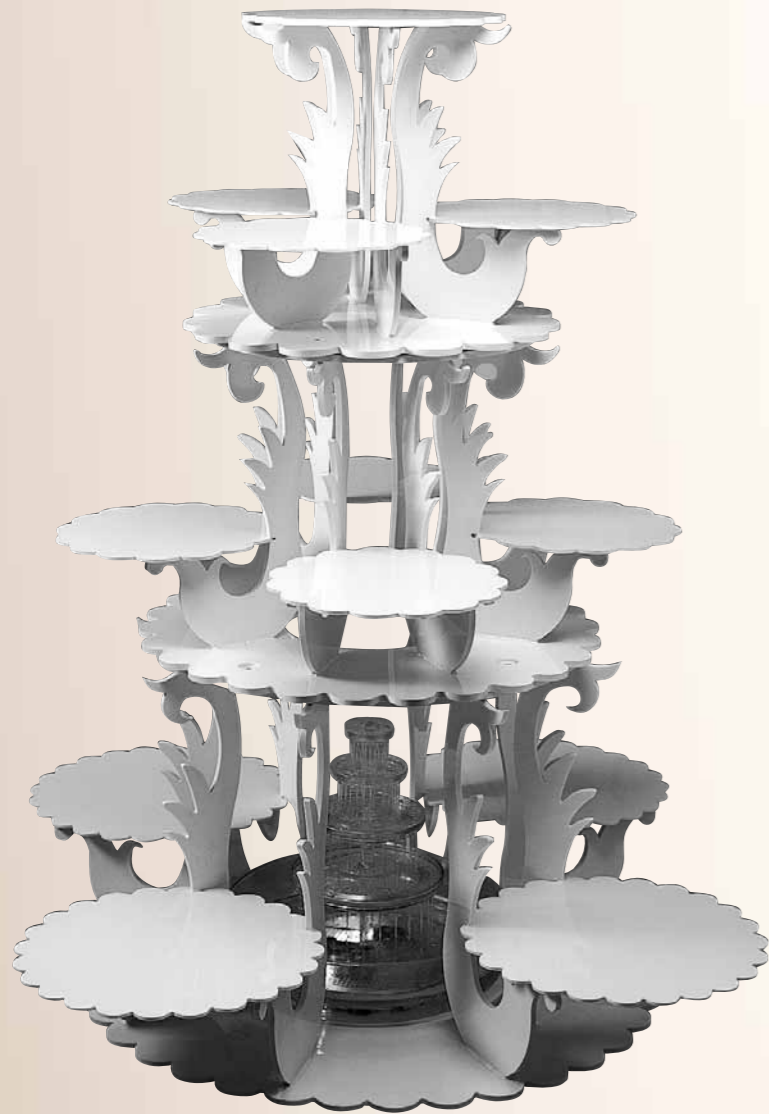

**Complete**

**COD. 160**

Misura - Size: Ø 110 h130 cm  
FONTANINA non inclusa - not included



**Small**

**COD. 163**

Misura - Size: Ø 40 h45 cm



**Medium**

**COD. 162**

Misura - Size: Ø 70 h42 cm



**Large**

**COD. 161**

Misura - Size: Ø 110 h51 cm  
FONTANINA non inclusa - not included

Unendo le alzate: Cod. 161 - Cod. 162 (senza i piedini) con Cod. 163 (senza i piedini) si ottiene Cod. 160  
Combining the cake stands: Cod. 161 - Cod. 162 (no feet) with Cod. 163 (no feet) you get Cod. 160

# MARGUERITE

Porz. - Portions: 115 - 125

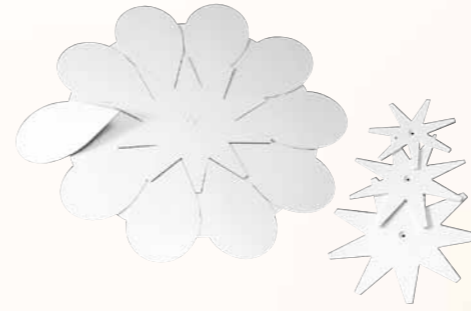

Fornita con quattro raggiere da 7/8/9/10 petali  
Endowed with four sets for 7/8/9/10 petals

**COD. 124**

Base Ø 90 cm  
petalo/petal 40 x 25 cm

# CONE

Base: Ø 52 cm



**COD. 184**

Misura - Size: Ø 52 h 40 cm

# BIG CONE

Base: Ø 62 cm



**COD. 185**

Misura - Size: Ø 62 h 50 cm

# THREE

Piatti - Plates:  
Ø 26 - h 1,5 cm



**COD. 402.01**

Misura - Size: Ø 56 - h 57 cm



**Piatto - Plate  
P402**

# LOTUS

Piatti - Plates:  
5 x 32x16 - 5 x 20x10 - 1 x Ø 18 cm  
Porz. - Portions: 55 - 60



**COD. 196**

Misura - Size: Ø 65 h 25 cm

# BIG LOTUS

Piatti - Plates:  
5 x 40x20 - 5 x 24x13 - 1 x Ø 22 cm  
Porz. - Portions: 60 - 80



**COD. 196/B**

Misura - Size: Ø 80 h25 cm

# PLEXI HEART

Piatti - Plates:  
Ø 25



**COD. 311**

Misura - Size: 60x70 h 79 cm

# DOUBLE HEARTS

È possibile usare singolarmente il cuore intero.  
It is possible to use the whole heart separately.



**COD. 126/B**

Piatti - Plates: 85 x 45 cm  
Porz. - Portions: 40 - 45



**COD. 126/A**

Piatti - Plates: 120 x 65 cm  
Porz. - Portions: 80 - 90



# PLASTIC DUMMIES

Tamburi in plastica. Ideali per realizzare wedding cake di grandi dimensioni.  
Plastic cake dummies. Ideal for creating large wedding cakes.

## Set 4 tamburi Set 4 dummies

**40-W106**

Misura - Size:  
Ø 50- 40 - 30 - 20 cm



## Tamburi Dummies

Size cm	Codice - Code
h 10 - Ø20	<b>40-W110</b>
h 10 - Ø30	<b>40-W111</b>
h 10 - Ø40	<b>40-W112</b>
h 10 - Ø50	<b>40-W113</b>

## Piatto antiscivolo Non-slip plate

**40-W124**

Misura - Size: Ø58 cm



## Pioli di sostegno per torta Plastic columns

**40-W101**

Misura - Size: Ø6 mm  
Pack 50 pcs

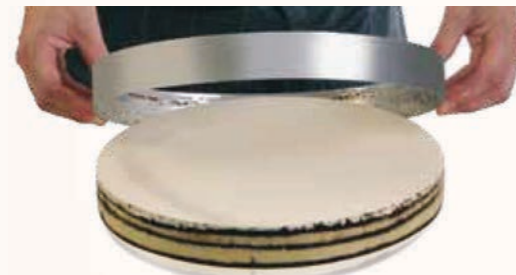

## Cerchi inox per tamburi St steel rings for dummies

Size cm	Codice - Code
h 5 - Ø19,5	<b>40-W087</b>
h 5 - Ø29,5	<b>40-W088</b>
h 5 - Ø39,5	<b>40-W089</b>
h 5 - Ø49,5	<b>40-W090</b>

Misura Size cm	Porzioni Portions	Piani Levels	Code METAL	Code PLASTIC
Ø 20 - 26 - 32	34-36	3	<b>METAL3</b>	<b>80-2003</b>
Ø 20 - 26 - 32 - 40	60-62	4	<b>METAL4</b>	<b>80-2004</b>
Ø 20 - 26 - 32 - 40 - 45	90-92	5	<b>METAL5</b>	<b>80-2005</b>
Ø 20 - 26 - 32 - 40 - 45 - 50	130-132	6	<b>METAL6</b>	<b>80-2006</b>
Ø 16 - 20 - 26 - 32 - 40 - 45 - 50	175-180	7	<b>METAL7</b>	<b>80-2007</b>
Ø 16 - 20 - 26 - 32 - 40 - 45 - 50 - 55	220-225	8	<b>METAL8</b>	<b>80-2008</b>
Ø 16 - 20 - 26 - 32 - 40 - 45 - 50 - 55 - 60	270-280	9	<b>METAL9</b>	<b>80-2009</b>

Alzate multipiano disponibili nella versione in metallo (METAL) e in resistente plastica bianca (PLASTIC).

Multi level cake stands available in metal version (METAL) or in resistant white plastic (PLASTIC)



metal

# INGLESE

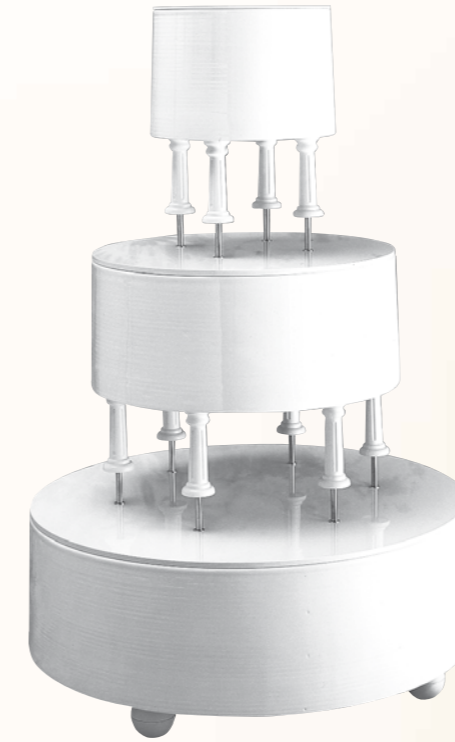

**COD. 158**

Misura - Size: h 105 cm

Piatti - Plates:  
Ø 28 - 48 - 68 cm  
Porz. - Portions: 105 - 115

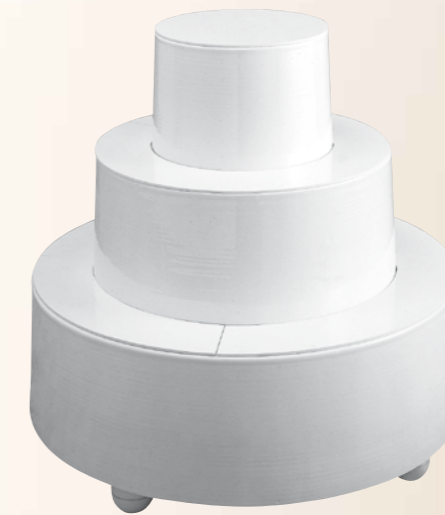

**COD. 155**

Misura - Size: h 65 cm

Piatti - Plates:  
Ø 28 - 48 - 68 cm  
Porz. - Portions: 60 - 70

## Accessori e ricambi Accessories and spare parts



**KIT 1**

Kit 4 columns and 1 plate Ø48 cm



**KIT 2**

Kit 4 columns and 1 plate Ø68 cm

## Little Wedding Cake



### Tonda - Round

**COD. 201**

Misura - Size: Ø 49 h 58 cm  
Piatti - Plates:  
Ø 49 - Ø 33 - Ø 17 cm



### Ovale - Oval

**COD. 202**

Misura - Size: 51x41 h 58 cm  
Piatti - Plates:  
51x41 - 35x25,5 - 19,5x10 cm



### Rettangolare - Rectangular

**COD. 203**

Misura - Size: 50x41 h 58 cm  
Piatti - Plates:  
50x41 - 35x25 - 19x9 cm



### Quadrata - Square

**COD. 204**

Misura - Size: 49x49 h 58 cm  
Piatti - Plates:  
49x49 - 33x33 - 17x17 cm

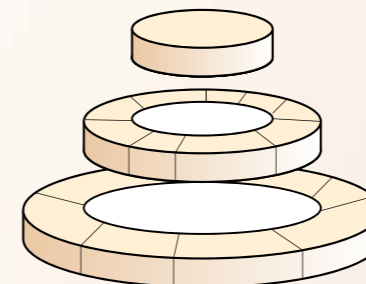

Preparare la base del pan di spagna da sagomare con l'aiuto dei piatti in plastica in dotazione in ogni little wedding cake;  
Prepare the sponge cake base to be shaped by using the plastic plates supplied with every Little Wedding Cake;

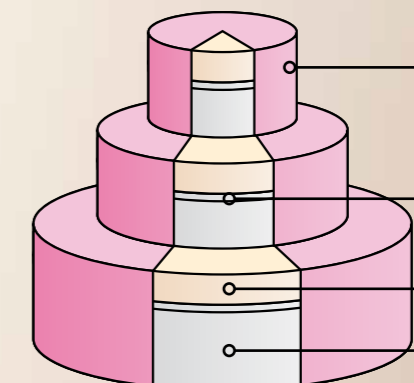

Copertura di pasta zucchero  
Sugarpaste coat

Piatto in plastica  
Plastic plate

Dolce / Cake

Tamburi / Dummies



## PLASTIC TRAYS

### TAVOLE PORTATORTA MULTIUSO

Realizzate in resistente materiale plastico, non assorbono odori ed umidità.  
Spessore 8 mm disponibili anche con piedini a sfera Ø 25 mm

### MULTIPURPOSE CAKE BOARD

Made in strong plastic material, smell and moisture resistant.  
Thickness 8 mm available with or without plastic feet Ø 25 mm

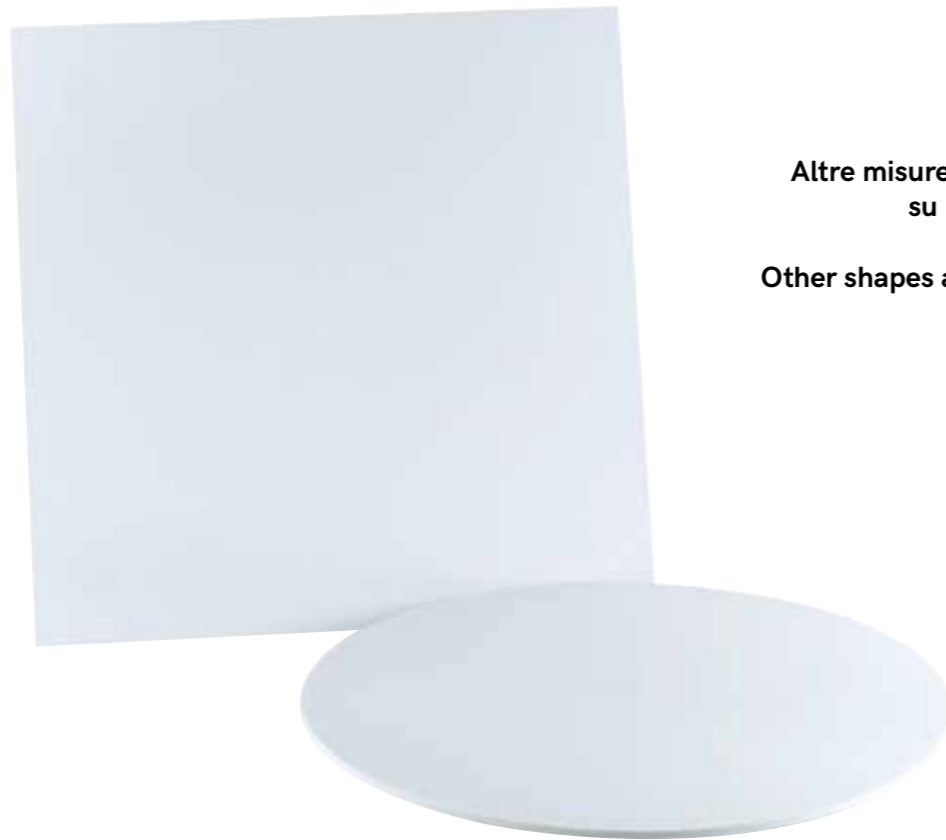

Altre misure forme realizzabili  
su richiesta.

Other shapes and sizes on request.

## MINI PLEXI DISPLAY

Piatto - Plate: 210mm



### Nero - Black

**COD. 80-0108** h 103 mm

**COD. 80-0208** h 163 mm

**COD. 80-0308** h 223 mm

### Satinato - Glazed

**COD. 80-0106** h 103 mm

**COD. 80-0206** h 163 mm

**COD. 80-0306** h 223 mm



### Fucsia - Fuchsia

**COD. 80-0409** h 103 mm

**COD. 80-0509** h 163 mm

**COD. 80-0609** h 223 mm

### Satinato - Glazed

**COD. 80-0406** h 103 mm

**COD. 80-0506** h 163 mm

**COD. 80-0606** h 223 mm

## CAKE BOARDS

Sottotorta monouso in plastica  
Disposable plastic cake boards - 20 pcs

Rotondi Round		Quadrati Square		Rettangolari Rectangular	
Size cm	Codice Code	Size cm	Codice Code	Size cm	Codice Code
Ø 16	<b>40-W056</b>	18x18	<b>40-W072</b>	23x33	<b>40-W066</b>
Ø 18	<b>40-W057</b>	20x20	<b>40-W073</b>	25x35	<b>40-W067</b>
Ø 20	<b>40-W058</b>	23x23	<b>40-W074</b>	28x38	<b>40-W068</b>
Ø 22	<b>40-W059</b>	25x25	<b>40-W075</b>	30x40	<b>40-W069</b>
Ø 24	<b>40-W060</b>	28x28	<b>40-W076</b>	32x48	<b>40-W070</b>
Ø 26	<b>40-W061</b>	30x30	<b>40-W077</b>	34x50	<b>40-W071</b>
Ø 28	<b>40-W062</b>	33x33	<b>40-W078</b>		
Ø 30	<b>40-W063</b>	35x35	<b>40-W079</b>		
Ø 32	<b>40-W064</b>	38x38	<b>40-W080</b>		
Ø 34	<b>40-W208</b>	40x40	<b>40-W081</b>		
Ø 36	<b>40-W209</b>				
Ø 38	<b>40-W210</b>				
Ø 40	<b>40-W065</b>				



## CAKE DOWEL RODS

Pioli per torte  
Cake dowel rods

Pioli di sostegno per torte  
Cake dowel rods

**40PI01**  
Ø 16 - 300mm  
Pack 12Pz



Kit taglia pioli  
Cutter kit  
**40KIT01**

Pioli, seghetto e dima  
Plastic dowel rods,  
hacksaw and support



### Rettangolare Rectangular

Misura Size cm	Piedini Feet	Codice Code
40x60	5	<b>TAV 40 X 60 C/P</b>
59x39	no	<b>TAV 59X39</b>
40x60	no	<b>TPP 60X40</b>
50x60	5	<b>TAV 50 X 60 C/P</b>
50x60	no	<b>TAV 50 X 60 PIA</b>
60x70	9	<b>TAV 60 X 70 C/P</b>
60x70	no	<b>TAV 60 X 70 PIA</b>
60x80	12	<b>TAV 60 X 80 C/P</b>
60x80	no	<b>TAV 60 X 80 PIA</b>
70x80	12	<b>TAV 70 X 80 C/P</b>
70x80	no	<b>TAV 70 X 80 PIA</b>
80x90	20	<b>TAV 80 X 90 C/P</b>
80x90	no	<b>TAV 80 X 90 PIA</b>
80x100	20	<b>TAV 80 X 100 C/P</b>
80x100	no	<b>TAV 80 X 100 PIA</b>

### Rotonda Round

Misura Size cm	Piedini Feet	Codice Code
Ø 40	5	<b>TAV D. 40 C/P</b>
Ø 40	no	<b>TAV D. 40 PIA</b>
Ø 50	5	<b>TAV D. 50 C/P</b>
Ø 50	no	<b>TAV D. 50 PIA</b>
Ø 60	5	<b>TAV D. 60 C/P</b>
Ø 60	no	<b>TAV D. 60 PIA</b>
Ø 70	9	<b>TAV D. 70 C/P</b>
Ø 70	no	<b>TAV D. 70 PIA</b>
Ø 80	9	<b>TAV D. 80 C/P</b>
Ø 80	no	<b>TAV D. 80 PIA</b>
Ø 90	9	<b>TAV D. 90 C/P</b>
Ø 90	no	<b>TAV D. 90 PIA</b>
Ø 100	13	<b>TAV D. 100 C/P</b>
Ø 100	no	<b>TAV D. 100 PIA</b>
Ø 120	13	<b>TAV D. 120 C/P</b>
Ø 120	no	<b>TAV D. 120 PIA</b>

### Quadrata Square

Misura Size cm	Piedini Feet	Codice Code
50x50	4	<b>TAV 50 X 50 C/P</b>
50x50	no	<b>TAV 50 X 50 PIA</b>
60x60	5	<b>TAV 60 X 60 C/P</b>
60x60	no	<b>TAV 60 X 60 PIA</b>
70x70	9	<b>TAV 70 X 70 C/P</b>
70x70	no	<b>TAV 70 X 70 PIA</b>
80x80	12	<b>TAV 80 X 80 C/P</b>
80x80	no	<b>TAV 80 X 80 PIA</b>
90x90	16	<b>TAV 90 X 90 C/P</b>
90x90	no	<b>TAV 90 X 90 PIA</b>

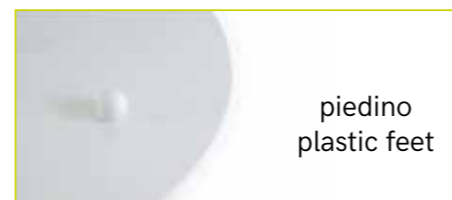

piedino  
plastic feet



# MULTI ICE revolution



**Multi Ice Revolution.** Stampi in speciale materiale plastico con l'aggiunta di uno strato esterno di resina arancione che conferisce ai due gusci più elasticità e resistenza durante l'espansione del ghiaccio. La guarnizione siliconica posizionata all'interno del guscio ed il sistema di fissaggio composto da un kit di volantini non permettono la fuoriuscita dell'acqua e consentono di riutilizzare più volte lo stampo.

**Multi Ice Revolution.** Moulds made of special plastic with an additional external orange resin layer which makes the two shells more elastic and more resistant against ice expansion. The silicone packing inside the shell and the fixing screws do not let the water come out and assure that the mould can be reused many times.



**MIR03**  
Sculpture: 37x25 h 58cm  
Mould: 65x25 h 69cm - 7kg



**MIR04**  
Sculpture: 48x56 h 15cm  
Mould: 60x61 h 15cm - 7kg



**MIR07**  
Sculpture: 41x41 h 83cm  
Mould: 51x96 h 41cm - 9kg



**MIR12**  
Sculpture: 48x56 h 19cm  
Mould: 71x56 h 20cm - 5,5kg



**MIR13**  
Sculpture: Ø48 h 19cm  
Mould: Ø62 h 20cm - 5kg



**MIR16**  
Sculpture: Ø40 h 20cm  
Mould: Ø52 h 23cm - 4kg



**MIR17**  
Sculpture: Ø39 h 15cm  
Mould: Ø53 h 19cm - 4,5kg



**MIR01**  
Sculpture: 42x26 h 53cm  
Mould: 60x25 h 65cm - 7kg



**MIR02**  
Sculpture: 47x26 h 56cm  
Mould: 67x29 h 62cm - 8kg



**MIR05**  
Sculpture: 36x26 h 67cm  
Mould: 50x26 h 78cm - 7,5kg



**MIR08**  
Sculpture: 58x25 h 56cm  
Mould: 69x25 h 70cm - 8kg



**MIR10**  
Sculpture: 46x33 h 86cm  
Mould: 60x100 h 33cm - 8kg



**MIR11**  
Sculpture: 35x25 h 71cm  
Mould: 53x26 h 82cm - 6kg

**Supporto per pompetta**  
**Air pump support**



Suitable for	Code
MIR01	<b>MIS01</b>
MIR02	<b>MIS02</b>
MIR03	<b>MIS03</b>
MIR05	<b>MIS05</b>
MIR08	<b>MIS08</b>
MIR11	<b>MIS11</b>



La pompetta tiene in movimento l'acqua all'interno dello stampo durante il processo di congelazione. Con l'aiuto di questi accessori la scultura di ghiaccio risulterà più trasparente.

The Air pump makes the water circulate inside the mould during the process of freezing. With the help of this accessory, the resulting ice sculpture will be more transparent.





# INDICE ALFABETICO

## ITALIANO

Descrizione	Pag
<b>A - B - C</b>	
ACETATI PVC	195
ADATTATORI BOCCHETTE	238
AEROGRAFI	295
AGHI PANETTONE	194
ALZATE TORTA	340
ANIMALETTI	48-56-74-95
BAFFI	42
BATTESIMI	118
BICCHIERINI MONOUSO	314-320
BILANCIA	247
BOCCHETTE	231
BORSETTA	44
BOTTIGLIE	258
CAKE IDEA	154
CANNELLI	285
CANNOLI	257
CAPPELLI	260
CARAFFE	259
CARAMELLIZZATORE	285
CARAMELLOMETRO	285
CARTA FORNO	253
CESTINI PANE	279
CHABLON DECORATIVI	41
CHITARRE	134
CIOTOLE	259
COLINO	248
COLORANTI ALIMENTARI	302
COLTELLI	245
COMBI 3D	151
COMUNIONE	120
CONTENITORI	290
COPERCHI	249
COPERTURE CARRELLI	281
COPPETTE MONOUSO	314-320
CRESIMA	120
CUCCHIAINI CIOCCOLATO	32
CUORI	14-17-34-41-106-108

Descrizione	Pag
<b>D - E - F - G - H</b>	
DECORAZIONI POLICARBONATO	37-67
DECORAZIONI POLITETLENE	40-52-73-80-96-122
DECORAZIONI SILICONE	41-66
DECORO CROSTATE, STAMPO	266
DESSERT IDEA	150
ECLAIR	190
ESPOSITORI	35-124-283
ESPOSITORI BUFFET	328
ESPOSITORI MACARON	287
ESTRATTORI	167-169
FASCE INOX	154-177
FETTA, STAMPO	170
FIORI	52-53-54
FLACONI	258
FLUTE	327
FOGLIE	51-53-54
FONTANE	142-343
FORBICI	285
FORCHETTINE PER CIOCCOLATO	122
FRUSTE	250
GELATI, STAMPI	198-207-209-211-213
GELATINE, STAMPI	193
GHIACCIOLI, STAMPI	201-203-205
GIRAPANETTONI	194
GIRATORTA	266
GRATTUGIE	251
GRIGLIE	251-274-277
GRIGLIE DECORO	299
GRIGNOTTINA	265
GUANTI	260-285
GUSCI CIOCCOLATO	30
HALLOWEEN	112

Descrizione	Pag
<b>L - M - N - O - P</b>	
LAMPADA DA ZUCCHERO	284
LIRA	267
LOLLIPOP	34-75-108-113-115
MACARON	51-192
MARZAPANE, ATTREZZI	298
MASCHERE CARNEVALE	111
MASCHERINE DECORO	296
MESSAGGI CIOCCOLATO	40
MICROFORATI	183
MIGNON	153-169
MONOPORZIONI	150-167
NAPOLITAIN	23-25
NATALE	58
NUMERI	39-57
OCCHIALI	42
ONE STRIP	148
PACKAGING	123-125
PALA PER DOLCI	267
PALLINATORE	265
PALLONE	43
PANDORI, STAMPO	194
PAPILLON	43
PASQUA	82
PENNELLI	261
PETTINI DECORATIVI	301
PIASTRA RISCALDANTE	264
PIATTINI MONOUSO	324-321
PIECE, STAMPI	117-118-121
PINZE	282
PIOLI PER TORTE	350-351
PORZIONATORI, GELATO	222
POSATINE MONOUSO	323-325
PRALINE	10-16-26-28-33-73-112
PRALINE 3D	26-28
PROFUMO	44
<b>R - S</b>	
RACLA	263
RASCHIETTI	223-268-269
RIGA	277
RULLI	257
RULLI FORAPASTA	255
S. VALENTINO	106
SAC A POCHE	227
SCARPE	43-45-46-52
SCIOGLITORI	128
SCULTURE GHIACCIO	354
SEGNAGUSTO	214

Descrizione	Pag
SEGNAPORZIONI	266
SEGNAPREZZO	282
SEMIFREDDI, STAMPI	145-154-161
SESSOLE	261
SETACCI	251-297
SFERE	29
SIFONE	247
SIGARO	42
SILICONE, STAMPI	186
SNACK	22-25
SOGGETTI CORPO CAVO	68-90-112
SOGGETTI IN SILICONE	46-76-100-107-114-116
SOGGETTI POLICARBONATO	74-95-106-113
SOGGETTI POLIETILENE	42-60-72-87
SOTTOTORTA	267-350-352
SPATOLE	242
SPATOLE GELATO	220-222
SPAZZOLE	261
STAMPI PANE	278
STENCIL DECORO	296-299
<b>T - U - V - Z</b>	
TAGLIA CROISSANT	256
TAGLIA PIZZA	255
TAGLIAPASTA ESTENSIBILE	257
TAGLIAPASTA INOX	270
TAGLIAPASTA PLASTICA	274
TAGLIERI	276
TAGLIERINI	280
TAMBURI PER TORTE	351
TAMPONE LEGNO	301
TAPPETI ANTIADERENTI	182-252
TAPPETI DECORO	300
TARTELLETTE	185
TAVOLE	352
TAVOLETTE	20-24
TAZZINE, CIOCCOLATO	32
TEGLIE	253-277
TELAI GANACHE	262
TELI PANE	281
TERMOMETRO	264-285
TORTIERE SILICONE	189
TRONCHETTI	171-173-174
UOVA DI CIOCCOLATO	84-92-98-102
VASCHETTE GELATO	223
VASSOI	124-191-249-289
VETRINE	288
ZUCCHERO, ACCESSORI	285
ZUCCOTTO	170



# ALPHABETICAL INDEX

## ENGLISH

Description	Pag
<b>A - C</b>	
ADAPTERS, PIPING TIPS	238
AIRBRUSH COMPRESSOR	295
ANIMALS MOULDS	48-56-74-95
BAKING PAPER	253
BAKING TRAY	253-277
BALL MACHINE	265
BARS CHOCOLATE MOULDS	20-24
BOARD, PLASTIC	352
BOTTLES, GRADUATED	258
BOWLS	259
BREAD BASKETS	279
BREAD CUTTERS	280
BREAD MOULDS	278
BREAD SHEETS	281
BRUSHES	261
CAKE BOARDS	267-350-352
CAKE DIVIDERS	266
CAKE IDEA	154
CAKE LIFTER	267
CAKE MOULDS, SILICONE	189
CAKE SLICER	267
CAKE STANDS	340
CAKE TURNTABLE	266
CARAFES	259
CARAMELISING ROD	285
CARAMELLOMETER	285
CARNIVAL MOULDS	111
CATERING DISPLAY	328
CHABLON	41
CHOCOLATE FOUNTAINS	142
CHOCOLATE MELTER	128
CHRISTMAS MOULDS	58
CIGAR MOULD	42
COLOURANT FOOD	302
COMBI 3D	151
COMBS	301
COMMUNION THEME MOULDS	120
CONFIRMATION THEME MOULDS	120

Description	Pag
CONTAINERS	290
COOKIES MAKER	265
CREAM HORNMOULD	257
CREAM WHIPPER	247
CROISSANT CUTTER	256
CUP, CHOCO MOULDS	32-42
CUTTER, PLASTIC	274
CUTTER, STAINLESS STEEL	270
CUTTING BOARD	276
CUTTING ROLLER	255
<b>D - K</b>	
DECORATION, POLICARBONATE	37-67
DECORATION, POLYETHYLENE	40-52-73-80-96-122
DECORATION, SILICONE	41-66
DESSERT IDEA	150
DISPLAYS	35-124-283
DISPOSABLE CUPS/GLASSES	314-320
DISPOSABLE DISHES	324-321
DISPOSABLE FLATEWARE	323-325
DISPOSABLE SEMIFREDDO MOULDS	148
DOWEL RODS FOR CAKE	350-351
DUMMIES, CAKE	351
ECLAIR	190
EGGS MOULDS	84-92-98-102
EXPANDING PASTY CUTTERS	257
EXTRACTORS	167-169
FLOUR SCOOP	261
FLOWERS	52-53-54
FLUTE	327
FORK, CHOCO	122
FRAME FOR GANACHE	262
GLOVES	260-285
GRATERS	251
GRATING PASTRY STENCIL	266
GUITARS CUTTER	134
HALLOWEEN	112
HANDBAG MOULDS	44
HATS, CHEF	260
HEARTS MOULDS	14-17-34-41-106-108

Description	Pag
HOLLOW FIGURES MOULD	68-90-112
ICE CREAM CONTAINER	223
ICE CREAM FLAVOUR MARKER	214
ICE CREAM MOULD	198-207-209-211-213
ICE CREAM SCOOP	222
ICE CREAM SPATULAS	220-222
ICE LOLLY MOULD	201-203-205
ICE SCULPTURES	354
ISOTHERMAL CONTAINERS	290
JELLY MOULDS	193
KNIVES	245
<b>L - P</b>	
LEAVES MOULDS	51-53-54
LIDS	249
LOG MOULDS	171-173-174
LOLLIPOPS	34-75-108-113-115
MACARON	51-192
MACARON DISPLAY	287
MARZIPAN TOOLS	298
MASK	296
MATS, NO STICK	182-252
MICROFORATI	183
MIGNON	153-169
MONOPORTION	150-167-170-183
MUSTACHE MOULD	42
NAPOLITAIN MOULDS	23-25
NEW BORN THEME MOULDS	118
NUMBERS MOULD	39-57
ONE STRIP	148
PACKAGING	123-125
PANDORO MOULD	194
PANETTONI TURNING ROD	194
PAPILLON MOULDS	43
PASTRY BAGS	227
PASTRY WHEEL	255
PERFUME MOULD	44
PIECE, MOULDS	117-118-121
PINCERS	282
PIPING TIPS	231
PISTON FUNNEL	248
PLASTIC RIBBONS /SHEETS	195
PLATE, PLASTIC	267-350-352
POLYCARBONATE FIGURE MOULD	74-95-106-113
POLYETHYLENE FIGURE MOULD	42-60-72-87
PRALINE 3D	26-28
PRALINE MOULDS	10-16-26-28-33-73-112
PRICE CARDS	282

Description	Pag
<b>R - Z</b>	
RACKS	251-274-277
RACLE SPATULAS	263
ROLLING PINS	257
RULERS	277
SCALE	247
SCISSORS	285
SCRAPERS	223-268-269
SEMIFREDDO MOULDS	145-154-161
SHEET, NYLON	281
SHOES MOULDS	43-45-46-52
SHOWCASES	288
SIEVES	251-297
SILICONE FIGURES MOULDS	46-76-100-107-114-116
SILICONE MOULDS	183-86
SNACK CHOCO MOULDS	22-25
SPATULAS	242
SPHERES MOULDS	29-72
SPOON MOULDS	32
STAINLESS STEEL BANDS	154-177
STENCILS	296
SUGAR LAMP	284
SUGAR THERMOMETER	285
TAG MOULDS	40
TARTLET MOULD	185
THERMOMETERS	264-285
TORCH, CHEF	285
TRAYS	124-191-249-289-352
TROLLEY COVER	281
VALENTINE'S DAY	106
WARMING PLATE	264
WEDDING THEME MOULDS	116
WHISKS	250



# INDICE NUMERICO NUMERICAL INDEX

Cod.	Pag	Cod.	Pag	Cod.	Pag
23027	113	11H4L24 /11H5L40	178	20-D015/19	39
103000	207	12H4X10 /12H5X30	178	20-D020/27	38
104000	211	13H4X15 / 13H4X30	179	20-D028	39
10-0078	213	14H4X16 / 14H4X30	179	20-D029	67
10-0083	213	15H4X25 /15H4X34	179	20EC01	191
10-4770	213	16H4X18 /16H5X28	179	20EC02	191
10-4887	213	17H4X17 /17H5X28	179	20FRUIT01 -03	27
10-4889	213	18H4X17 /18H5X26	179	20GU001/07	31
105000/ 03	201	19H2X25 /19H5X30	181	20GU500/03	31
10-6191	213	1H2X10 /1H5X30	177	20H2X16 /20H5X31	180
10-6798	213	20-1010 /11	52	20HO01	64
10B10	216	20-3D1001/03	28	20L001/04	34
10CG01 /04	222	20-3D2001/03	28	20L005	75
10-E001	207	20-3D3001/6001	28	20L006	113
10-E002	201	20-4000	143	20OB01	42
10-E003 /05	199	20A3D01	60	20OR001	89
10-E015	213	20A3D02	61	20PA01	44
10-EV008/15	213	20-B001/003	35	20PP01	43
10PG01 /05	222	20BA01	44	20PR01	65
10SEG	218	20BC100	63	20-R4000	143
10SEG01	218	20-C017	34	20-S001/003	35
10SEG01EN	218	20-C024	75	20-S1010	80
10SEG02	219	20-C1000/02	74	20-S2010	96
10SEG02EN	219	20-C1003/05	74	20SC01	105
10SEG03	219	20-C1006 /008	95	20SF001/02	29
10SEG04	219	20-C1009/10	74	20SF003/006	72
10SEG051	215	20-C1011	103	20SI01	42
10SEG10	215	20-C1955/57	95	20SL01	64
10SEGB	216	20-CA001 /012	111	20TEC1K	175
10SEGC10	216	20-CA100	55	20TES001/07	173
10SG00 /100	220	20CO01/02	62	20U032N	104
10SGC00 /100	221	20-CU001	104	20U064N	104
10-W001 /14	199	20-D001/14	37	20-U1010 /011	102

Cod.	Pag	Cod.	Pag	Cod.	Pag
20U105N	104	30MICRO01 /010	183	30SM083	47
20U130N	104	30ONE18/20	148	30SM084	46
20U150N	104	30SM001/04	76	30SM085	119
20U175N	104	30SM005	114	30SM086	114
20U204N	104	30SM006	49	30SM087	77
20U227N	104	30SM007/10	76	30SMA001 /011	79
20U258	104	30SM011/12	119	30SMF01/03	51
20U320	104	30SM013	114	30SMG01/03	99
20U3D01	86	30SM014/16	115	30SML001	115
20U3D02	85	30SM017	78	30SML002	75
20U3D03	84	30SM018	77	30SML003	108
20U3D04	85	30SM019	115	30SMS00	99
20U3D05	84	30SM020/21	101	30SMT01	51
20U3D06	87	30SM022 /027	100	30SMTP01 /03	117
20UB100	88	30SM028 /030	101	30SMTP04	118
21H2X20 /21H5X35	180	30SM031	49	30SMTP05	121
21H2X20G	163	30SM032	48	30SMW01 /04	116
21H2X21	162	30SM033	119	30SP0100 /1000	194
21H2X23	163	30SM034/35	49	30SS01/06	161
21H2X26	162	30SM036	119	30TA01050 /05055	185
21H2X26G	163	30SM037	120	30TB3S	171
21H2X31	163	30SM038	120	30TB4S	175
21VA085	104	30SM039/40	107	30TC0016	175
21VA102	104	30SM041/42	48	30TC001K	174
22BOX48 /85	123	30SM043	120	30TCDECO1K	175
22H4X23 /22H5X36	181	30SM044	49	30TE3001R / 6002R	190
23002/24	40	30SM045/46	50	30TM3001R	192
23025/26	73	30SM047	120	30TM6001R	192
23H2X18 /23H5X35	180	30SM049/50	107	30TS000	171
24H4X15 /24H5X25	181	30SM051	50	30TS001/ 018	173
25H4X15 /25H5X25	181	30SM054	47	30TT104S	171
26H4X14 /26H4X23	181	30SM055/57	48	31CUT01 /02	191
27H4X12 /27H4X16	179	30SM058	77	31H4X11 /31H5X11	181
28H4X15 /28H4X20	179	30SM059/60	49	32H4X18S	159
29002/ 03	35	30SM061 /064	115	32H4X22S	159
29H4X09 /29H4X12	179	30SM065/69	49	33H4X20S	158
2H4X10 /2H5X30	177	30SM070	114	33H4X24S	158
30CH001	194	30SM071	50	33KITH4X20	158
30COMBI01/03	146	30SM072/74	78	33KITH4X24	158
30H4X01 /30H4X10	181	30SM075	75	34H4X16S	159
30IDEA01 /06	152	30SM076/82	78	34H4X20S	159



Cod.	Pag	Cod.	Pag	Cod.	Pag	Cod.	Pag	Cod.	Pag	Cod.	Pag
34KITH4X16	159	50CI22X14	257	53GP01	194	BASKET 102 /208	279	BX 1123	236	BX0041	236
34KITH4X20	159	50CO001	248	53TA60402	253	BBP1 /3	241	BX 1132	236	BX0042	232
35H4X14S	158	50CO30X12	257	53TA60404	253	BC 0855	234	BX 1217	235	BX0043	233
35H4X19S	158	50CO35X14	257	53TAF60404	253	BC 320/ 330	231	BX 1303	235	BX0044	233
35KITH4X19	158	50CO40X16	257	53TL60402	253	BC 300/302	232	BX 1405	235	BX0045/48	232
36H4X22S	157	50COL01 /07	245	53TL60404	253	BF 0867	231	BX 1510	232	BX0049	233
36KITH4X22	157	50CORICO	248	55TP22080	281	BF 0869	231	BX 1605	236	BX0050	232
37H4X22S	156	50CORIC1 /7	248	55TP6080	281	BF 310/ 319	231	BX 1713	236	BX0051 /62	237
37KITH4X22	156	50CP01	281	5H2X16	161	BIM 232	236	BX 1820	232	BX0100 /104	238
38H4X22S	156	50-CS100	137	5H2X20	161	BIM 340	236	BX 1906	233	BX9990	235
38KITH4X22	156	50F001	285	5H4X10 /5H5X30	177	BO100N /1000	258	BX 2013	234	BX9991	235
39H4X20S	155	50FA01 /06	250	60P001....	327	BOS 24 /60	240	BX 2117	236	BX9992	235
39H4X24S	155	50FL00C	258	70H2X13	162	BOS12FLO	240	BX 2219	236	BXB01	236
39KITH4X20	155	50GIRA02	194	70H2X19	162	BOSPL 1 /4	241	BX 2312	233	BXB02	236
39KITH4X24	155	50GO075/400	244	7H4X10 /7H5X28	177	BPL 6	241	BX 2314	233	CANNELLO PRO	285
3H4X10 /3H5X9	177	50PF00	258	80-0106/80-0609	353	BR 330	234	BX 2315	233	CANNELLOBIG	285
40KIT01	353	50PP01	285	80-2003/09	350	BR 331	234	BX 3005	233	CANNELLOBL	285
40PI01	353	50RAS1/2	269	8H4X10 /8H5X30	178	BR 332	234	BX 4014	234	CANNOLO	257
40-W021 /154	254	50RT....	268	90- CLASSIC	52	BRU	241	BX 5017	234	CAP 1 /4	260
40-W056/ 081	353	50SA150B /250	243	90-3301	112	BS 0195	235	BX 6018	234	CARNEVAL 1 /2	111
40-W087 /90	350	50SG250B/350	243	90-9991	32	BS 0195K	235	BX 7020	234	CF 1 /5	259
40-W101/124	350	50SI01	247	90-CUORI HEART	109	BS 0D6K	234	BX 8019	233	CFTRA 1 /6	259
40-W125	266	50SI02	247	90-NATALE CHRISTMAS	80	BS 0F6K	234	BX 9017	232	CHASIL 1/28	41
40-W208 / 210	350	50SL300B/370	243	90-PASQUA EASTER	96	BS 10 S	241	BX 9022	232	CHASIL29/30	66
40-WA010	238	50SP300B/ 400	243	90-UOVA/ EGGS	103	BS 10 T	241	BX0001	232	CHIT15	139
40-WC015/322	308	50SPA15/ 30	242	9H4X10 /9H5X28	178	BS 102 /118	231	BX0002/008	237	CHIT22	139
40-WC600/619	307	50SPANG09/20	242	AG05601 /08101	287	BST100	203	BX0009	232	CHIT30	139
40-WCA301 / 419	306	50SR340	244	AG09002/03	222	BT 202 /224	231	BX0011	237	CHITBA24	139
40-WCB200/217	311	50ST01	281	AG360165120MNG1	223	BX 0108	234	BX0012	236	CHITBAD24	139
40-WCP508 /517	309	50T001	264	AG360165120MNG2	223	BX 0116	235	BX0014	237	CHITCOMP	135
4H4X10 /4H5X25	177	50T002	264	AG36025080MNG1	223	BX 0119	235	BX0016	237	CHITDOUBLE	135
50-0030 /065	227	50VA001A	228	AG36025080MNG2	223	BX 0120	235	BX0017	237	CHITMINI	139
50-1030/65	227	50VP...	289	AG362512POLB	223	BX 0123	235	BX0023	237	CHITMINI15	139
50AD001 /04	238	50VP00402	191	AG362512POLN	223	BX 0134	233	BX0026	233	CHITMINI30	139
50BI01	247	50WA004B/006B	298	AG36258POLB	223	BX 0158	233	BX0027	233	CHITMINID22	139
50BI02	247	50ZES01 /3	251	AG36258POLN	223	BX 0190	234	BX0028 /34	232	CHITMINID30	139
50-C015/045	137	51CF6040	253	AR0001	288	BX 0250	232	BX0035	236	CHITP	139
50CA..	291	51EC2512	190	AR00011	288	BX 0252	232	BX0036	236	CHITRIC....	135
50-CD100N	137	51EC6018	190	AR02801	288	BX 0510	234	BX0037	236	CHOC0101 /110	122
50CI.. (ISOTHERMAL)	290	51MA0032	192	BA 411	234	BX 1013	234	BX0038	232	CHOCOBIG	143
50CI12X20	257	52BO13PC /38PP	259	BA 413	235	BX 1105	236	BX0039	233	CHOCOBIGRING	143
50CI16X20	257	53GP01	194	BA 415	235	BX 1115	236	BX0040	233	CHOCOBIGRING06	143



Cod.	Pag	Cod.	Pag	Cod.	Pag	Cod.	Pag	Cod.	Pag	Cod.	Pag
CHOCOFONT	143	COD. 190	346	COD. 603	329	DECOF01	295	GD2/4	277	MA1955	22
CHOCOFORK	122	COD. 192	347	COD. 604	124	DECOH01	295	GD3/6	277	MA1973/75	73
CHOCORING	143	COD. 196	349	COD30400	337	DECOMP 7	295	GIRA /6	266	MA1978	23
CHOCORING06	143	COD. 196/B	349	COD30400	337	DECOMP9	295	GL 1 /11	260	MA1984	73
CIOK 1	265	COD. 201/204	351	COD30408	337	DECOR 30	266	GL 6 /9	285	MA1990/91	73
CLP01	205	COD. 300	335	COD30408	337	DECOV01	295	GL18PRE	260	MA1992	112
CLPESPO15	205	COD. 301	334	COD32100	339	DISCO20 /34	267	GL25PRE	260	MA1993 - 94	17
CLPESPO21	205	COD. 302	335	COD32100	339	DRIP	188	GPO22	298	MA1995	106
CLPESPOB	205	COD. 303	339	COD32108	339	ED 1 /9	169	GS01/ 22	299	MA1996	106
CLPESPOBTRA	205	COD. 304	337	COD32108	339	EEX 001	170	GST01 /03	209	MA2000	21
COATING	304	COD. 305	331	COD33201	329	EEX 01	170	GST10	209	MA2001	21
COD. 101	343	COD. 307	331	COD33301	329	EEX 1	170	GSTESP...	210	MA2002	23
COD. 102	343	COD. 308	335	COD33401	329	EL101	35	GTB01 /23	274	MA2004	21
COD. 103	343	COD. 309	333	COD33501	330	EL201/9	35	INOX 3	269	MA2005	21
COD. 104	343	COD. 310	333	COD33608	339	EL306/9	35	KIT 1/2	351	MA2006	23
COD. 111	343	COD. 311	349	COD33701	333	EM 01 /4	167	KITMS1/S4	297	MA2007	23
COD. 113/A	341	COD. 312	329	COD33906	333	EM 16	170	LAMP01	284	MA2008-MA200	20
COD. 117	347	COD. 316	337	COD34001	333	EM 5 /13	168	LAMPLEX	284	MA2011	25
COD. 118	347	COD. 320	333	COD35101	331	ESPICE	203	LCA000/219	307	MA3000/04	39
COD. 124	349	COD. 321	339	COD512	345	ESPICE14	203	LCA300 /309	306	MA3005	39
COD. 126/A	349	COD. 322	335	COD513	344	ESPICE21	203	LCA408 /419	306	MA3006	32
COD. 126/B	349	COD. 32416	334	COD514	345	ESPO B	239	LCAS100	304	MA4000/03	33
COD. 127	347	COD. 32418	334	COD60501	329	ESPO ST	239	LCB200/210	311	MA5000/03	29
COD. 130	341	COD. 32508	339	COLONNA	343	ESPO20GU001	31	LCG001/25	310	MA6001 -05	23
COD. 131	341	COD. 32518	335	COLONNINA	343	ESPOB60	239	LCJ000	311	MA6006	25
COD. 132	341	COD. 32715	337	CON 17/19	297	ESPOBO32	239	LCJ100	311	MAC000S/002S	71
COD. 150	347	COD. 32717	337	COVER 3 /8	249	ESPOSITORE	283	LCP003/119	308	MAC122S	70
COD. 152	346	COD. 32816	337	CS3	267	ESPOWG70GP	283	LCP202/218	309	MAC130S	70
COD. 153	346	COD. 32901	332	CSM040	141	ESPOWMONOUSO	283	LCP300/311	308	MAC140S	71
COD. 155	351	COD. 33001	331	CSM04001/4009	141	ET001 / 006	125	LCP502/519	310	MAC170S	70
COD. 158	351	COD. 33101	335	CSM0402	141	EUROCHOCK	304	LCS001 /09	305	MAC190S	71
COD. 159	347	COD. 33118	335	CSM060	141	EXTRA C	170	LCS200	304	MAC200S	71
COD. 160	348	COD. 402.01	349	CSM06001/6009	141	EXTRA C001	170	LCS215 /220	305	MAC240S	70
COD. 161	348	COD. 500	334	CSM0602	141	EXTRA C01	170	LCV000 /107	303	MAC281S	71
COD. 162	348	COD. 501	334	CSMSPB40	263	FLACONE	258	LCV100	304	MAC300S	71
COD. 163	348	COD. 503	334	CSMSPB60	263	FLAN1	258	MA1002-MA1979	11 15	MAC310S	71
COD. 180	346	COD. 504	342	CUT....	270-273	FLEX 025 CM /070	228	MA1700	22	MAC320S/321S	70
COD. 183	346	COD. 507	341	CUTTER 1 /15	280	FLU01	327	MA1805	22	MAC322S/323S	43
COD. 184	349	COD. 508	341	CUTTER 50	188	FONTANINA	343	MA1806	22	MAC324S	112
COD. 185	349	COD. 509	341	CUTTER 80	188	FW...	323	MA1807	21	MAC325S	112
COD. 187	347	COD. 510	331	DECOAIR 2 /6	295	FW003/004	325	MA1910 -19	22	MAC326S	45
COD. 188	346	COD. 511	331	DECOCP01	295	GD 01 /22	299	MA1951/54	32	MAC327S	47

Cod.	Pag	Cod.	Pag	Cod.	Pag	Cod.	Pag	Cod.	Pag	Cod.	Pag
MAC328S	46	MONOP. A001 /C004	167	PMOCO008/010	315	RLS50PE /70PE	254	SPB SPECIAL	263	TLS05	262
MAC329S	46	MONOP. A0016	170	PMOCO011	317	RLT 5/10/15	254	SPB40	262	TLSPECIAL	262
MAC401S/404S	70	MONOP. A005/C013	168	PMOCO012	317	RO 1/14	297	SPBMINI	263	TPB1	170
MAC405S/406S	113	MONOP. A016	170	PMOCO013	315	ROLL H 30 /H65	227	SPR034	229	TPEX 1	170
MAC407S	69	MONOP. B0016	170	PMOCO014	315	ROTAPINOX....	257	SPR034/C	229	TPG 01/4	167
MAC408S	68	MONOP. B016	170	PMOCO015	317	RPL 12	255	SPR045	229	TPG 5/ 13	168
MAC409S	68	MONOP. C0016	170	PMOCU001/003	316	RPL 6	255	SPR045/C	229	TPG16	170
MAC410S	71	MONOP. C101	170	PMOCU004...	316	RPL12INOX	255	SPR050	229	TPGSET	271
MAC411S/413S	69	MRTE	285	PMOJA001/002	320	RPS 6	255	SPR050/C	229	TPGSET/2	271
MAC421S	71	MSC001 /501	125	PMOLO001....	319	RSC110X150	256	SPZ INOX	261	TPM 1/9	169
MAC602S/604S	92	MSP 250/350	244	PMOPE001....	315	RSC180X140	256	SPZ PL1	261	TPMSET	271
MAC610S	93	MTE	285	PMOTO001/004	319	RSC180X200	256	SPZ PL3	261	TPP 60X40	352
MAC611S /616S	90	NSA ....	195	PMOTO005....	318	RSC97X210	256	SPZ SE	261	TS1	267
MAC620S	93	NSA62X117	170	PMOVA001/003	326	RTC180X200	256	SS001 /36	165	VASSOIO....	249
MAC630S	93	P402	349	PMSPOON	298	RTRA 1 /5	223	ST 1 /4	171	VB00102/ 408	288
MAC661S	93	PALL 1 /3	265	POMP	285	RTRA1-5	223	STD 025 CM /075 CM	228	VC30X40	249
MAC670S	93	PC001 /04	255	PORTFLACONE	258	SAC 25/ 100	229	STLG100	199	VC60X40	249
MAC720S	93	PC55 /120	255	PPT 12- 14/18X	266	SAC45X100	229	STPK	279	VC60X404	249
MAC740S	93	PD 1/2 -PD13/14	301	PR001	264	SAC58X100	229	STPTA 1 /5	279	VP00101 /012	124
MAC760S	93	PDM 1/2 - 13/14	301	PR30/40	251	SBIKIT01	203	STPTA 6 /14	278	VS00101	289
MAC800S/920S	94	PDS1/2 - 13/14	301	PR30X30	251	SCA 10	254	STPZ	278	ZENBO00	321
MAC950S	93	PEM20 /PEMS70	261	PR40X60	251	SCC01	32	SUT25X17	102	ZENBO00C	321
MAC952S	93	PINZA /X4	282	PR50X50	251	SCI01	347	SUT28X18	102	ZENBO01	321
MACL01	122	PIRAMTP 02/07	170	PRA 9	272	SCM 30 /40	243	SUT34X25	102	ZENBO02	321
MASK 01 /307	296	PL00100/00202	324	QG 10 /15	263	SCSP01 /04	298	SUT40X27	102	ZENTRO0	321
MC000305	132	PMFORK	298	QG 3/5	263	SEG001N / 027N	282	SUT45X32	102	ZENTRO1	321
MC001001	133	PMKNIFE	298	RAS 3 /8	269	SES 100 /1500	261	SUT54X36	102	ZENTRO2	321
MC09G/V	132	PMO07....	318	RC110 /115	269	SET DISK	267	SUT64X43	102		
MC10	133	PMO08....	318	RD105/ 175	269	SETAC 16 /30	251	SUT75X50	102		
MC100/MC108	131	PMO09.....	322	RDC180X200	256	SETACIOK	297	TAG 4 / 9	276		
MCAR	285	PMO10.....	322	RELIEF 1 /12	300	SF 3	170	TAV 40X60 C/P - TAV D.120	352		
MCD101/104	129	PMO11.....	322	RETH4	178	SF001 /09	186	TC001/5 - TC003/5	21		
MCDA103/04	128	PMO12....	322	RETH5	178	SF010 /45	187	TEFLONPAT	252		
MD 2	295	PMO13....	325	RETSPECIAL 1	178	SF046/180	188	TFL 10	301		
MEL 250 /450	244	PMO14.....	325	RETSPECIAL 2	178	SF180		TFL 15	301		
METAL 3/9	350	PMO15.....	325	RFP 12	255	SFT 118/Y -730Y	189	TFP 8 /26	277		
MEX 250 /500	244	PMOCE001/003	317	RFP 6	255	SG 01 /09	193	TFRU 25 /50	250		
MFRU 25 /50	250	PMOCO001/003	320	RFP12INOX	255	SGM00 /100	221	TL 02 / 15	263		
MIGNON A001/C009	169	PMOCO004	318	RIGA64	277	SILICOPAT1/B - 7/R	252	TLM03	262		
MIP	355	PMOCO005	318	RIGAKIT	277	SM 1000 /4000	103	TLM05	262		
MIRO1/ 17	354	PMOCO006	318	RL 1 /4	254	SMA110 /320	275	TLMINI	262		
MIS01/11	355	PMOCO007	318	RLS 30 /60	254	SPB	263	TLS03	262		



**Martellato srl, ai sensi della Legislazione Comunitaria vigente:**

Regolamento CE n. 1935/2004  
Materiali e oggetti destinati a venire a contatto con i prodotti alimentari.

Regolamento UE n. 10/2011  
Riguardante i materiali e gli oggetti di materia plastica  
destinati a venire a contatto con i prodotti alimentari.

Regolamento CE n. 2023/2006  
Buone pratiche di fabbricazione (GMP) dei materiali e degli oggetti  
destinati a venire a contatto con i prodotti alimentari.

**E alla seguente Legislazione Nazionale vigente:**

D.M. Italiano 21/03/1973 e successive modifiche  
Disciplina igienica degli imballaggi, recipienti, utensili, destinati a venire a contatto  
con le sostanze alimentari o con sostanze d'uso personale.

D.P.R. 777/82 e successivi aggiornamenti e modifiche

**Ha emesso uno specifico Capitolato che obbliga i suoi fornitori al rispetto  
di determinate precauzioni igieniche durante la fabbricazione,  
lavorazione e imballo degli articoli Monouso elencati nel presente catalogo.  
Per tutti gli altri articoli la Martellato srl richiede all'utilizzatore la precauzione  
di lavarli accuratamente con acqua e detergente neutro prima dell'uso.**

**Martellato srl, accordingly to EC laws:**

EC Regulation no. 1935/2004  
Materials and articles intended to come into contact with food.

EU Regulation no. 10/2011  
Regarding the materials and plastic articles intended to come into contact with food.

EC Regulation no. 2023/2006  
Good Manufacturing Practices (GMP) of materials and articles intended to come into contact with food.

**And to the following National Legislation in force:**

Italian Ministerial Decree 21/03/1973 and subsequent updates and changes  
Hygiene regulation for packaging, containers, utensils, intended to come into contact with food  
or with substances for personal use.

**Presidential Decree 777/82 and subsequent updates and changes**

**Issued a specification that requires its suppliers to comply with certain hygienic precautions  
during manufacture, processing and packaging of the disposable items listed in this catalogue.  
For all other items Martellato srl asks users to wash thoroughly  
with water and mild detergent before use, as a precaution.**

MARTELLATO si riserva la facoltà di modificare in qualsiasi momento e senza preavviso  
le caratteristiche tecniche degli articoli presentati in questo catalogo.  
È vietata la riproduzione, anche parziale, di questo catalogo senza l'autorizzazione di MARTELLATO

MARTELLATO reserves the right to modify at any time without notice the technical specifications of the items in this catalogue.  
Any reproduction, even partial, of this catalogue without permission is strictly prohibited.